

Contents

1	Instructions	54
1.1	General safety instructions	54
1.2	Identification plate	58
1.3	Manufacturer liability	58
1.4	Appliance purpose	58
1.5	This user manual	58
1.6	Disposal	59
1.7	How to read the user manual	59
2	Description	60
2.1	General Description	60
2.2	Cooking hob	61
2.3	Control panel	61
2.4	Other parts	62
2.5	Available accessories	63
3	Use	65
3.1	Instructions	65
3.2	First use	66
3.3	Using the accessories	66
3.4	Using the hob	68
3.5	Using the storage compartment	69
3.6	Using the oven	69
3.7	Cooking advice	73
3.8	Programmer clock	74
4	Cleaning and maintenance	81
4.1	Instructions	81
4.2	Cleaning the appliance	81
4.3	Removing the doors	82
4.4	Cleaning the door glazing	83
4.5	Cleaning the inside of the ovens	83
4.6	Pyrolytic cycle	83
4.7	Extraordinary maintenance	85
5	Installation	86
5.1	Gas connection (not valid for the UK)	86
5.2	Adaptation to different types of gas	89
5.3	Electrical connection	94
5.4	Positioning	96
5.5	Instructions for the installer	100

We advise you to read this manual carefully, which contains all the instructions for maintaining the appliance's aesthetic and functional qualities.

For further information on the product: www.smeg.com



Instructions

1 Instructions

1.1 General safety instructions

Risk of personal injury

- During use the appliance and its accessible parts become very hot. Never touch the heating elements during use.
- Protect your hands by wearing oven gloves when moving food inside the oven.
- Never try to put out a fire or flames with water: turn off the appliance and smother the flames with a fire blanket or other appropriate cover.
- This appliance may be used by children aged at least 8 and by people of reduced physical, sensory or mental capacity, or lacking in experience in the use of electrical appliances, provided that they are supervised or instructed by adults who are responsible for their safety.
- Children must never play with the appliance.
- Keep children under the age of 8 at a safe distance unless they are constantly supervised.
- Keep children under the age of 8 away from the appliance when it is in use.
- Cleaning and maintenance must not be carried out by unsupervised children.
- Make sure that the flame-spreader crowns are correctly positioned in their seats with their respective burner caps.
- Be aware of how rapidly the cooking zones heat up. Do not place empty pans on the heat. Danger of overheating.
- Fats and oils can catch fire if they overheat. Do not leave the appliance unattended while preparing foods containing oils or fats. If fats or oils catch fire, never put water on them. Place the lid on the pan and turn off the relevant cooking zone.
- Cooking process should always be kept under control. A short cooking process must be continuously surveyed.
- While cooking do not place metal objects, such as cutlery or dishes on the hob surface as they may overheat.
- Do not insert pointed metal objects (cutlery or utensils) into the slots in the appliance.
- Do not pour water directly on very hot trays.
- Keep the oven door closed during cooking.



- If you need to move food or at the end of cooking, open the door 5 cm for a few seconds, let the steam come out, then open it fully.
- Do not open the storage compartment (where present) when the oven is on and still hot.
- The items inside the storage compartment could be very hot after using the oven.
- DO NOT USE OR STORE FLAMMABLE MATERIALS IN THE STORAGE COMPARTMENT (IF AVAILABLE) OR NEAR THE APPLIANCE.
- DO NOT USE AEROSOLS IN THE VICINITY OF THIS APPLIANCE WHILST IT IS IN USE.
- Switch off the appliance after use.
- DO NOT MODIFY THIS APPLIANCE.
- Before any operation on the appliance (installation, maintenance, positioning or movement) always wear PPM.
- Before performing any operation on the appliance, switch off the power supply.
- Have qualified personnel carry out installation and assistance interventions according to the standards in force.
- Do not try to repair the appliance yourself or without the intervention of a qualified technician.
- Do not pull the cable to remove the plug.
- If the power supply cable is damaged, contact technical support immediately and they will replace it.

Risk of damaging the appliance

- Do not use abrasive or corrosive detergents (e.g. scouring powders, stain removers and metallic sponges) on glass parts.
- Use wooden or plastic utensils.
- Racks and trays should be inserted as far as they will go into the side guides. The mechanical safety locks that prevent them from being removed must face downwards and towards the back of the oven.
- Do not sit on the appliance.
- Do not use steam jets to clean the appliance.
- Do not obstruct ventilation openings and heat dispersal slots.
- Never leave the appliance unattended during cooking operations where fats or oils could overheat and take fire. Be very careful.
- Never leave objects on the cooking surface.



Instructions

- DO NOT USE THE APPLIANCE TO HEAT ROOMS FOR ANY REASON.
- Do not spray any spray products near the oven.
- Do not use plastic cookware or containers for cooking.
- Do not place sealed tins or containers in the oven cavity.
- Remove all trays and racks which are not required during cooking.
- Do not cover the bottom of the oven cavity with aluminium or tin foil sheets.
- Do not place pans or trays directly on the bottom of the oven cavity.
- If you wish to use greaseproof paper, place it so that it will not interfere with the hot air circulation inside the oven.
- Do not use the open door to place pans or trays on the internal glazing pane.
- Cooking vessels or griddle plates should be placed inside the perimeter of the hob.
- All pans must have smooth, flat bottoms.
- If any liquid does boil over or spill, remove the excess from the hob.
- Take care not to spill acid substances such as lemon juice or vinegar on the hob.
- Do not put empty pans or frying pans on switched on cooking zones.
- Do not use steam jets to clean the appliance.
- Do not use rough or abrasive materials or sharp metal scrapers.
- Do not use cleaning products containing chlorine, ammonia or bleach on parts made of steel or that have metallic surface finishes (e.g. anodizing, nickel- or chromium-plating).
- Do not use abrasive or corrosive detergents (e.g. scouring powders, stain removers and metallic sponges) on glass parts.
- Do not wash the removable components such as the hob grids, flame-spreader crowns and burner caps in a dishwasher.
- Never use the oven door to lever the appliance into place when fitting.
- Avoid exerting too much pressure on the door when open.
- Do not use the handle to lift or move this appliance.



Installation

- THIS APPLIANCE **MUST NOT BE INSTALLED** IN A BOAT OR CARAVAN.
- This appliance must not be installed on a pedestal.
- Position the appliance into the cabinet cut-out with the help of a second person.
- To prevent any possible overheating, the appliance should not be installed behind a decoration door or a panel.
- Have the gas connection performed by authorised staff.
- Installation using a hose must be carried out so that the length of the hose does not exceed 2 metres when fully extended for steel hoses and 1.5 metres for rubber hoses.
- The hoses should not come into contact with moving parts and should not be crushed in any way.
- If required, use a pressure regulator that complies with current regulations.
- After carrying out any operation, check that the tightening torque of gas connections is between 10 Nm and 15 Nm.
- At the end of the installation, check for any leaks with a soapy solution, never with a flame.
- Have the electrical connection performed by authorised technicians.
- The appliance must be connected to ground in compliance with electrical system safety standards.
- Use cables withstanding a temperature of at least 90°C.
- The tightening torque of the screws of the terminal board leads must be 1.5 - 2 Nm.
- Before installation, make sure that the local distribution conditions (nature and pressure of the gas) and the adjustment of the appliance are compatible;
- The adjustment conditions for this appliance are shown on the gas setting label.
- This appliance is not connected to an exhaust system for combustion products. It must be installed and connected in compliance with the current installation regulations. Special attention should be paid to the relevant requirements as for ventilation.



Instructions

For this appliance

- Ensure that the appliance is switched off before replacing the bulb.
- Do not rest any weight or sit on the open door of the appliance.
- Take care that no objects are stuck in the doors.

1.2 Identification plate

The identification plate bears the technical data, serial number and brand name of the appliance. Do not remove the identification plate for any reason.

1.3 Manufacturer liability

The manufacturer declines all liability for damage to persons or property caused by:

- use of the appliance other than that specified;
- failure to comply with the instructions in the user manual;
- tampering with any part of the appliance;
- the use of non-original spare parts.

1.4 Appliance purpose

- This appliance is intended for cooking food in the home environment. Every other use is considered inappropriate.
- The appliance is not designed to operate with external timers or with remote-control systems.

1.5 This user manual

This user manual is an integral part of the appliance and must therefore be kept in its entirety and within the user's reach for the whole working life of the appliance.

- Read this user manual carefully before using the appliance.



1.6 Disposal



This appliance must be disposed of separately from other waste (Directives 2002/95/EC, 2002/96/EC, 2003/108/EC).

The appliance does not contain substances in quantities sufficient to be considered hazardous to health and the environment, in accordance with current European directives.

To dispose of the appliance:

- Cut the power supply cable and remove it along with the plug.



Power voltage Danger of electrocution

- Disconnect the mains power supply.
- Unplug the appliance.
- Deliver the appliance to the appropriate recycling centre for electrical and electronic equipment waste, or return it to the retailer when purchasing an equivalent product, on a one for one basis.

Our appliances are packaged in non-polluting and recyclable materials.

- Deliver the packing materials to the appropriate recycling centre.



Plastic packaging Danger of suffocation

- Do not leave the packaging or any part of it unattended.
- Do not let children play with the plastic bags.

1.7 How to read the user manual

This user manual uses the following reading conventions:

Instructions



General information on this user manual, on safety and final disposal.

Description



Description of the appliance and its accessories.

Use



Information on the use of the appliance and its accessories.

Cleaning and maintenance



Information for proper cleaning and maintenance of the appliance.

Installation



Information for the qualified technician: Installation, operation and inspection.



Safety instructions



Information



Advice

1. Sequence of instructions for use.

- Standalone instruction.



Description

2 Description

2.1 General Description

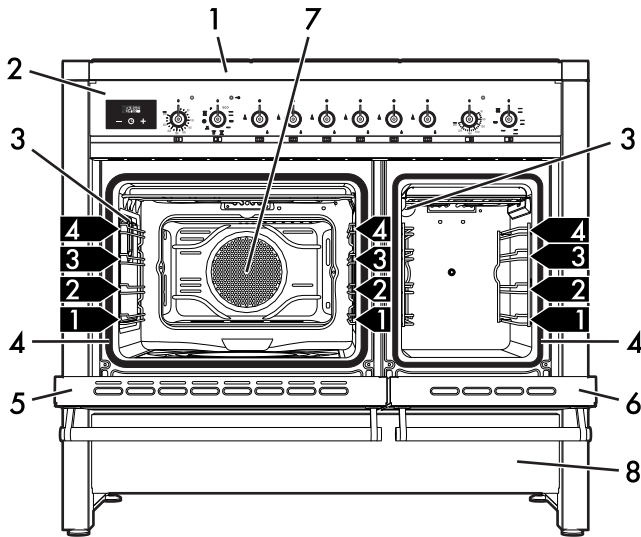

- 1 Cooking hob
- 2 Control panel
- 3 Oven light
- 4 Seal
- 5 Main oven door

- 6 Auxiliary oven door
- 7 Fan
- 8 Storage compartment
- 1,2,3...** Rack/tray support frame shelf



2.2 Cooking hob

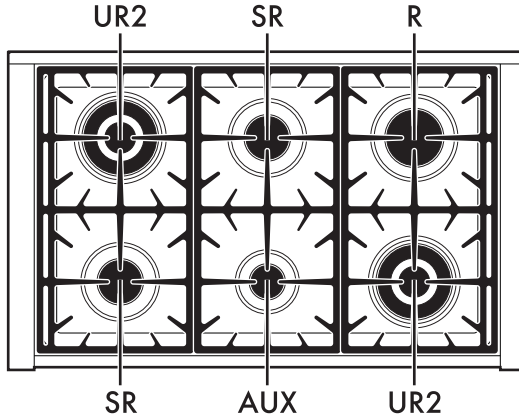

AUX = Auxiliary
SR = Semi-rapid

R = Rapid
UR2 = Ultra-rapid

2.3 Control panel

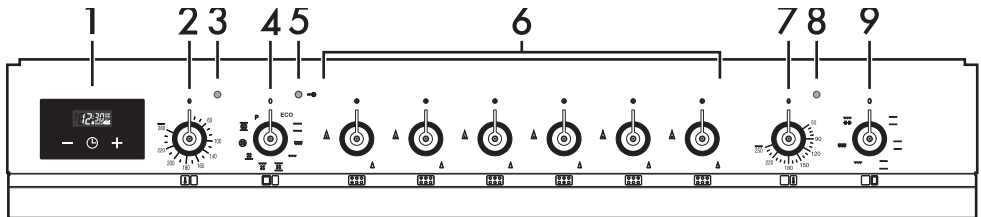

1 Programmer clock

Useful for displaying the current time, setting programmed cooking operations and programming the minute minder timer.

2 Main oven temperature knob

This knob allows you to select the cooking temperature.

Turn the knob clockwise to the required value, between the minimum and maximum setting.

3 Main oven indicator light

The indicator light comes on to indicate that the oven is heating up. It turns off as soon as it reaches the set temperature. It flashes regularly to indicate that the temperature set inside the oven is kept constant.

4 Main oven function knob

The oven's various functions are suitable for different cooking methods. After selecting the required function, set the cooking temperature using the temperature knob.





Description

5 Door lock indicator light

It comes on when the automatic (pyrolytic) cleaning cycle is activated.

6 Hob burner knobs

Useful for lighting and adjusting the hob burners.

Press and turn the knobs anti-clockwise to the value  to light the relative burners. Turn the knobs to the zone between the maximum  and minimum  setting to adjust the flame.

Return the knobs to the  position to turn off the burners.

7 Auxiliary oven temperature knob

This knob allows you to select the cooking temperature.

Turn the knob clockwise to the required value, between the minimum and maximum setting.

8 Auxiliary oven indicator light

The indicator light comes on to indicate that the oven is heating up. It turns off as soon as it reaches the set temperature. It flashes regularly to indicate that the temperature set inside the oven is kept constant.

9 Auxiliary oven function knob

The oven's various functions are suitable for different cooking methods. After selecting the required function, set the cooking temperature using the temperature knob.

2.4 Other parts

Shelves

The appliance features shelves for positioning trays and racks at different heights. The insertion heights are indicated from the bottom upwards (see 2.1 General Description).

Cooling fan

The fan cools the ovens and comes into operation during cooking.

The fan causes a steady outflow of air that exits from the rear of the appliance and which may continue for a brief period of time even after the appliance has been turned off.

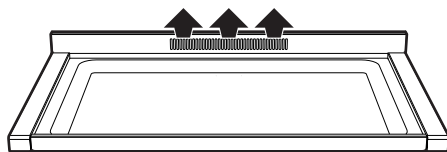

Interior lighting

The appliance interior lighting comes on:

- When the door is opened
- When any function is selected, apart from the Pyrolytic and ECO functions.



2.5 Available accessories

i The oven accessories intended to come into contact with food are made of materials that comply with the provisions of current legislation.

i Supplied original and optional accessories can be requested to Authorised Assistance Centres. Use only original accessories supplied by the manufacturer.

WOK ring

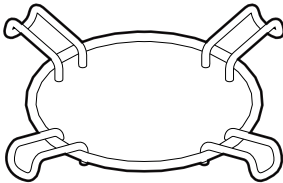

Useful when using a wok.

Raised pan support

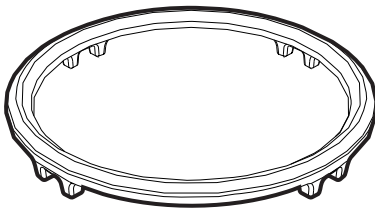

To prevent damage to the worktop, a raised pan support is available to place under pans having a diameter greater than those indicated in the "Cookware

diameters" table in section 3.3 "Using the hob".

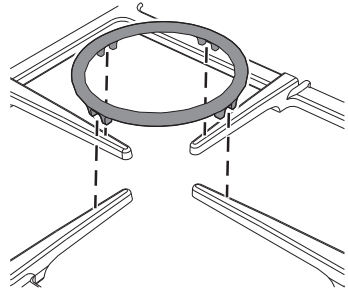

The pan support must be placed on the hob grid as shown in the figure above.

In any case, pans with a diameter greater than 26 cm must be used solely on the Ultra-rapid burner (**UR2**).

This pan support can also be used with woks.

Oven tray

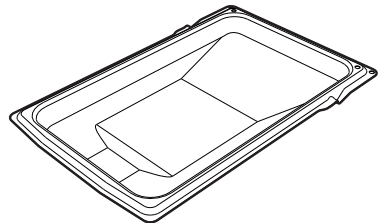
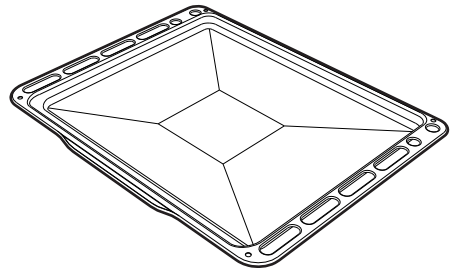

Useful for collecting fat from foods placed on the rack above.

EN



Description

Deep tray

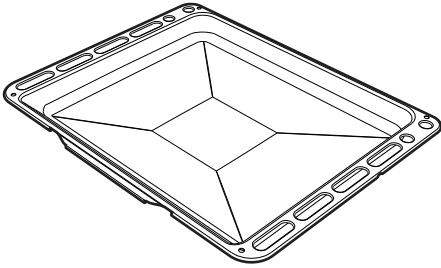

Useful for collecting fat from foods placed on the rack above and for cooking pies, pizzas and baked desserts.

Rack

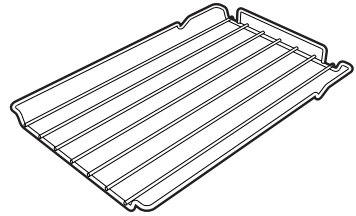
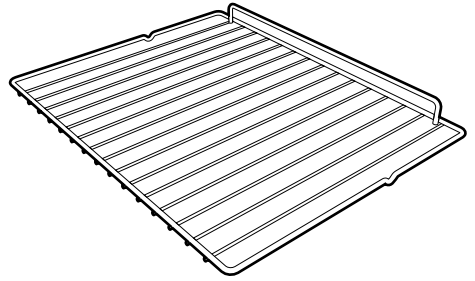

Useful for supporting containers with food during cooking.

Rotisserie support (auxiliary oven)

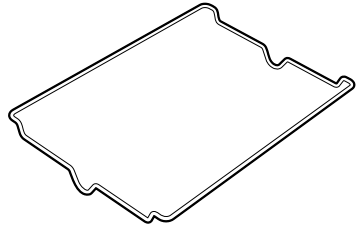

To be used to support the rotisserie rod.

Rotisserie rod (auxiliary oven)

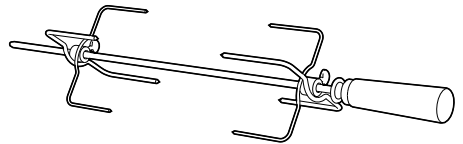

Useful for cooking chicken and all foods which require uniform cooking over their entire surface.

Tray rack

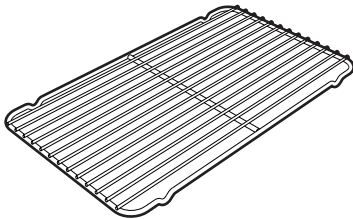
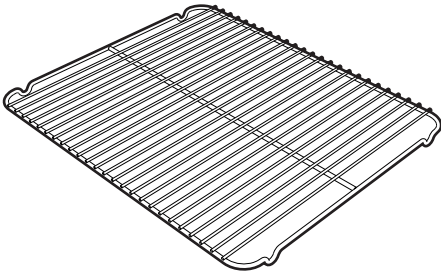

To be placed over the top of the oven tray; for cooking foods which may drip.



3 Use

3.1 Instructions



High temperature inside the oven during use
Danger of burns

- Keep the oven door closed during cooking.
- Protect your hands wearing heat resistant gloves when moving food inside the oven.
- Do not touch the heating elements inside the oven.
- Do not pour water directly onto very hot trays.
- Do not allow children younger than 8 years old to come near the appliance when in operation.
- If you need to move food or at the end of cooking, open the door 5 cm for a few seconds, let the steam come out, then open it fully.



High temperature inside the storage compartment
Danger of burns

- Do not open the storage compartment when the oven is on and still hot.
- The items inside the storage compartment could be very hot after using the oven.



Improper use
Danger of burns

- Make sure that the flame-spreader crowns are correctly positioned in their housings with their respective burner caps.
- Oils and fats could catch fire if overheated. Be very careful.



High temperature inside the oven during use
Danger of fire or explosion

- Do not spray any spray products near the oven.
- Do not use or leave flammable materials near the oven or the storage compartment.
- Do not use plastic kitchenware or containers when cooking food.
- Do not put sealed tins or containers in the oven.
- Do not leave the oven unattended during cooking operations where fats or oils could be released.
- Remove all trays and racks which are not required during cooking.



Improper use

Risk of damage to surfaces

- Do not cover the bottom of the oven cavity with aluminium or tin foil sheets.
- If you wish to use greaseproof paper, place it so that it will not interfere with the hot air circulation inside the oven.
- Do not place pans or trays directly on the bottom of the oven cavity.
- Do not use the open door to rest pans or trays on the internal glass pane.
- Do not pour water directly onto very hot trays.
- Make sure that the flame-spreader crowns are correctly positioned in their housings with their respective burner caps.
- Cooking vessels or griddle plates should be placed inside the perimeter of the hob.
- All pans must have smooth, flat bottoms.
- If any liquid does boil over or spill, remove the excess from the hob.

3.2 First use

1. Remove any protective film from the outside or inside of the appliance, including accessories.
2. Remove any labels (apart from the technical data plate) from the accessories and from the cooking compartments.
3. Remove all the accessories from the appliance and clean them (see 4 Cleaning and maintenance). Heat the empty ovens at the maximum temperature to burn off any residues left by the manufacturing process.

3.3 Using the accessories

Tray rack

The tray rack has to be inserted into the tray. In this way fat can be collected separately from the food which is being cooked.

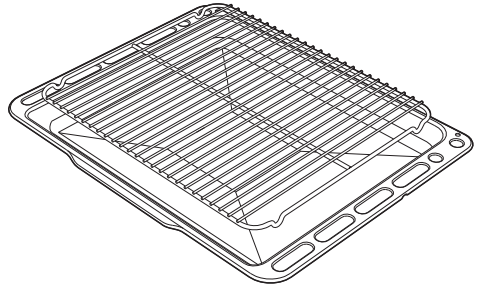



Racks and trays

Racks and trays have to be inserted into the side guides until they come to a complete stop.

- The mechanical safety locks that prevent the rack from being taken out accidentally have to face downwards and towards the oven back.

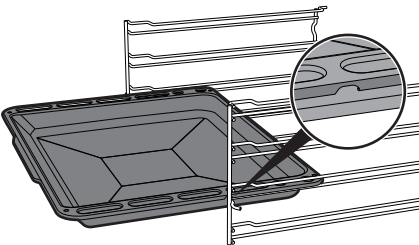
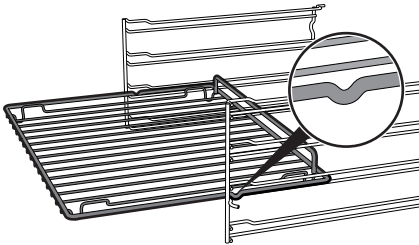

Gently insert racks and trays into the oven until they come to a stop.



Clean the trays before using them for the first time to remove any residues left by the manufacturing process.

Ring reducers

The ring reducers have to be placed on the hob grids. Make sure they are properly placed.

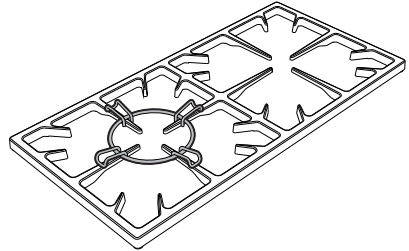

Auxiliary oven rotisserie

1. Position the rotisserie support on the third shelf of the auxiliary oven.
2. Screw on the handle provided so that you can handle the rod with the food on it readily.
3. Once you have prepared the rotisserie rod, place it on the rotisserie support. The pin must be correctly positioned on the shaped part **A**.



4. Insert the rod into the hole **B** so that it connects with the rotisserie motor.

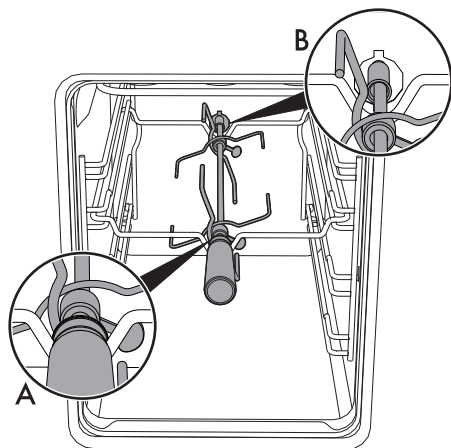

3.4 Using the hob

All the appliance's control and monitoring devices are located together on the front panel. The burner controlled by each knob is shown next to the knob. The appliance is equipped with an electronic ignition device. Simply press the knob and turn it anti-clockwise to the maximum flame symbol, until the burner lights. If the burner does not light in the first 15 seconds, turn the knob to  and wait 60 seconds before trying again. After lighting, keep the knob pressed in for a few seconds to allow the thermocouple to heat up. The burner may go out when the knob is released: In this case, the thermocouple has not heated up sufficiently. Wait a few moments and repeat the operation. Keep the knob pressed in longer.



Remove the handle before closing the door



We recommend that you place the tray on the first shelf to collect fats more easily.



Pour a little water into the drip tray to prevent smoke from forming.



In case of an accidental switching off, a safety device will be tripped, cutting off the gas supply, even if the gas tap is open. Return the knob to  and wait at least 60 seconds before lighting it again.



Correct positioning of the flame-spreader crowns and burner caps

Before lighting the hob burners, make sure that the flame-spreader crowns are correctly positioned in their housings with their respective burner caps. Make sure that the holes in the flame-spreader crowns are aligned with the igniters and thermocouples (A).

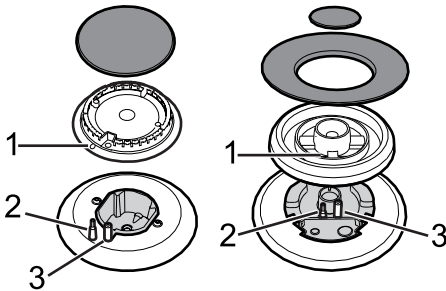

Practical tips for using the hob

For better burner efficiency and to minimise gas consumption, use pans with lids and of suitable size for the burner, so that flames do not reach up the sides of the pan. Once the contents come to the boil, turn down the flame far enough to ensure that the liquid does not boil over.



Cookware diameters:

- **AUX:** 12 - 14 cm.
- **SR:** 16 - 24 cm.
- **R:** 18 - 26 cm.
- **UR2:** 18 - 26 cm.

Cookware diameters with raised pan support:

- **UR2:** 26 - 28 cm.

3.5 Using the storage compartment

The storage compartment is at the bottom of the cooker. To open it, pull the handle towards you. It can be used to store cookware or metallic objects necessary when using the appliance.

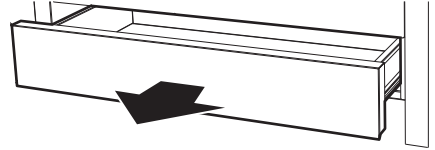

3.6 Using the oven

Switching on the oven

To switch on the oven:

1. Select the cooking function using the function knob.
2. Select the temperature using the temperature knob.



Regular flashing of the thermostat indicator light during cooking is normal and indicates that the temperature is being maintained constant inside the oven.



Main oven functions

ECO

This function is particularly suitable for cooking on a single shelf with low energy consumption. It is recommended for all types of food except those that may produce a large amount of moisture (e.g. vegetables).

To obtain maximum energy savings and reduce cooking times, it is recommended to place food in the oven without preheating.

i When using the ECO function, avoid opening the door during cooking.

i Cooking (and preheating) times are longer with the ECO function and may depend on the amount of food in the oven cavity.

i The ECO function is a delicate cooking function and is recommended for cooking that does not require temperatures higher than 210°C. It is recommended that you select a different function for cooking at higher temperatures.

Static

As the heat comes from above and below at the same time, this system is particularly suitable for certain types of food. Traditional cooking, also known as static cooking, is suitable for cooking just one dish at a time. Perfect for all types of roasts, bread and cakes, and in any case, particularly suitable for fatty meats such as goose and duck.

Wide grill

The heat coming from the grill element gives perfect grilling results above all for thin and medium thickness meat and, in combination with the rotisserie (where fitted), gives the food an even browning at the end of cooking. Perfect for sausages, spare ribs and bacon. This function enables large quantities of food, particularly meat, to be grilled evenly.

Small grill

Using only the heat released from the central element, this function allows you to grill small portions of meat and fish for making kebabs, toasted sandwiches and any types of grilled vegetable side dishes.



Fan assisted

The operation of the fan, combined with traditional cooking, ensures consistent cooking even with complex recipes. Perfect for biscuits and cakes, even when simultaneously cooked on several levels. (For multiple-level cooking, we recommend using the 2nd and 4th shelves).



Fan with grill

The air produced by the fan softens the strong heatwave generated by the grill, grilling perfectly even very thick foods. Perfect for large cuts of meat (e.g. shin of pork).



Fan + lower element

The combination of the fan with just the lower heating element allows cooking to be completed more rapidly. This system is recommended for sterilising or for finishing off the cooking of foods which are already well-cooked on the surface, but not inside, which therefore need a little more heat. Perfect for any type of food. In pyrolytic models, the special defrost and proving functions are brought together under the same function.



Fan with circulaire

The combination of the fan and the circulaire heating element (incorporated in the rear of the oven) allows you to cook different foods on several levels, as long as they need the same temperatures and same type of cooking. Hot air circulation ensures instant and even distribution of heat. It will be possible, for instance, to cook fish, vegetables and biscuits simultaneously (on different levels) without odours and flavours mingling.



Turbo

The combination of fan assisted cooking and traditional cooking allows different foods to be cooked on several levels extremely quickly and efficiently, without odours and flavours mingling. Perfect for large volumes that call for intense cooking.



Pyrolytic

Setting this function, the oven reaches temperatures up to 500°C, destroying all the grease which forms on the internal walls.



Auxiliary oven functions



Static

As the heat comes from above and below at the same time, this system is particularly suitable for certain types of food. Traditional cooking, also known as static cooking, is suitable for cooking just one dish at a time. Perfect for all types of roasts, bread and cakes, and in any case, particularly suitable for fatty meats such as goose and duck.



Upper element

The heat coming just from the top is ideal for foods which require final browning without the need to use the grill.



Lower element

The heat coming just from the bottom allows you to complete the cooking of foods that require a higher bottom temperature, without affecting their browning. Perfect for cakes, pies, tarts and pizzas.



Small grill

Using only the heat released from the central element, this function allows you to grill small portions of meat and fish for making kebabs, toasted sandwiches and any types of grilled vegetable side dishes.



Wide grill

The heat coming from the grill element gives perfect grilling results above all for thin and medium thickness meat and, in combination with the rotisserie (where fitted), gives the food an even browning at the end of cooking. Perfect for sausages, spare ribs and bacon. This function enables large quantities of food, particularly meat, to be grilled evenly.



Grill + rotisserie

The rotisserie works in combination with the grill element, allowing food to be perfectly browned.



3.7 Cooking advice

General advice

- Use a fan assisted function to achieve consistent cooking at several levels.
- It is not possible to shorten cooking times by increasing the temperature (the food could be overcooked on the outside and undercooked on the inside).
- Using more ovens at the same time might affect the final cooking results.

Advice for cooking meat

- Cooking times vary according to the thickness and quality of the food and to consumer taste.
- Use a meat thermometer when roasting meat, or simply press on the roast with a spoon. If it is hard, it is ready; If not, it needs another few minutes cooking.

Advice for cooking with the Grill and the Fan with grill

- Meat can be grilled even when it is put into the cold oven or into the preheated oven if you wish to change the effect of the cooking.
- With the Fan with grill function, we recommend that you preheat the oven before grilling.
- We recommend placing the food at the centre of the rack.

- With the Grill function, we recommend that you turn the temperature knob to the maximum value near the  symbol to optimise cooking.
- Foods should be seasoned before cooking. Foods should also be coated with oil or melted butter before cooking.
- Use the oven tray on the first bottom shelf to collect fluids produced by grilling.
- Grilling processes should never last more than 60 minutes using multifunction ovens, 30 minutes inside the auxiliary oven.

Advice for cooking desserts/pastries and biscuits

- Use dark metal moulds: They help to absorb the heat better.
- The temperature and the cooking time depend on the quality and consistency of the dough.
- To check whether the dessert is cooked right through: At the end of the cooking time, put a toothpick into the highest point of the dessert. If the dough does not stick to the toothpick, the dessert is cooked.
- If the dessert collapses when it comes out of the oven, on the next occasion reduce the set temperature by about 10°C, selecting a longer cooking time if necessary.
- While cooking desserts or vegetables, excessive condensation may form on the glass. In order to avoid this, open the door very carefully a couple of times while cooking.



Use

Advice for defrosting and proving

- Place frozen foods without their packaging in a lidless container on the first shelf of the oven.
- Avoid overlapping the food.
- To defrost meat, use the rack placed on the second level and a tray on the first level. In this way, the liquid from the defrosting food drains away from the food.
- The most delicate parts can be covered with aluminium foil.
- For successful proving, a container of water should be placed in the bottom of the oven.

To save energy

- Stop cooking a few minutes before the time normally used. Cooking will continue for the remaining minutes with the heat which has accumulated inside the oven.
- Reduce any opening of the door to a minimum to avoid heat dispersal.
- Keep the inside of the appliance clean at all times.

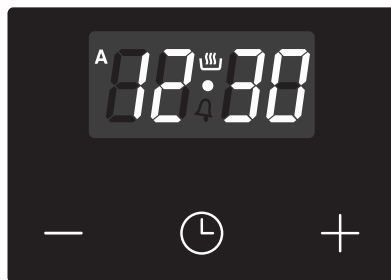

3.8 Programmer clock





 Value decrease button

 Clock button

 Value increase button

 Ensure that the programmer clock shows the cooking duration symbol , otherwise it will not be possible to turn on the oven. Press the  button to reset the programmer clock.

 The programmer clock only controls the main oven.

 The use of the auxiliary oven is independent of the settings made to the main oven or to the electronic programmer.







Setting the time





If the time is not set, the oven will not switch on.

On the first use, or after a power failure, the digits  will be flashing on the appliance's display.

1. Hold down the clock button  for two seconds. The dot between the hours and the minutes flashes.
2. The time can be set via the value increase  button and value decrease  button. Keep the button pressed in to increase or decrease rapidly.
3. Wait 7 seconds. The dot between the hours and the minutes stops flashing.
4. The  symbol on the display indicates that the appliance is ready to start cooking.













To change the time, hold down the value increase  button and value decrease  button at the same time for two seconds, then set the time.

Timed cooking



Timed cooking is the function which allows a cooking operation to be started and then ended after a specific length of time set by the user.

1. Keep the clock button  pressed until the  symbol appears.
 2. Press the clock button  again. On the display the  symbol and the text  appear, alternating with the current time.
 3. Use the value increase  and value decrease  buttons to set the required minutes of cooking.
 4. Select a function and a cooking temperature.
 5. Wait approx. 5 seconds without pressing any button in order for the function to activate. The current time and the  and  symbols will appear on the display.
- At the end of cooking the heating elements will be deactivated. On the display, the  symbol turns off, the  symbol flashes and the buzzer sounds.
6. To turn the buzzer off, simply press one of the programmer clock buttons.



Use

- Press the clock button to reset the programmer clock.

i It is not possible to set a cooking time of more than 10 hours.

To cancel the set programming press and hold down the value increase and the value decrease buttons at the same time and then turn the oven off manually.

Programmed cooking

i Programmed cooking is the function which allows a cooking operation to be started at a set time and then ended after a specific length of time set by the user.



- Set the cooking time as described in the previous point "Timed cooking".
- Hold the menu button down for 2 seconds.
- Press the menu button again. The display will show the digits and the text in sequence, while the **A** symbol flashes (for example, the current time is 17:30).

- Press the or button to set the required minutes. (for example 1 hour).
- Press the menu button . The text will appear on the display in sequence with the pre-set cooking duration added to the current time (for example, the cooking end time shown is 18:30).
- Press the or button to set the cooking end time. (for example, 19:30).

Bear in mind that a few minutes for oven preheating must be added to the cooking time.

- Wait approx. 7 seconds without pressing any button in order for the function to activate. The current time appears and the and symbols light up on the display.
- Select a cooking temperature and function.
- At the end of cooking the heating elements will be deactivated. On the display, the symbol turns off, the **A** symbol flashes and the buzzer sounds.



10. Return the function and temperature knobs to **0**.
11. To turn off the buzzer just press any button of the programmer clock.
12. Press the  and  buttons at the same time to reset the set program.





It is not possible to set a cooking time of more than 10 hours.



It is not possible to set a programmed cooking time of more than 24 hours.











After setting, hold the menu button  down for 2 seconds to display the cooking time remaining. Press the menu button  again. The display shows the text  and the remaining cooking time in sequence.

Minute minder timer



The minute minder timer does not stop the cooking operation but rather informs the user when the set time has run out.

The minute minder timer can be activated at any time.



1. Keep the clock button  pressed for a few seconds. The display shows the figures  and the  symbol flashing between the hours and minutes.
 2. Use the value increase  and value decrease  buttons to set the number of minutes required.
 3. Wait approx. 5 seconds without pressing any button to finish setting the minute minder. The current time and the  and  symbols appear on the display.
- A buzzer will sound when the set time is reached.
4. Press the value decrease  button to turn the buzzer off.





The minute minder timer can be set from 1 minute to a maximum of 23 hours and 59 minutes.



Modifying the set data





1. Press the clock button .
2. Use the value increase  and value decrease  buttons to set the number of minutes required.

Deleting the set data

1. Press the clock button .
2. Hold down the value increase  and value decrease  buttons at the same time.
3. Then switch off the oven manually if cooking is in progress.

Selecting the buzzer

The buzzer can have 3 tones.

1. Hold down the value increase  and value decrease  buttons at the same time.
 2. Press the clock button .
- Press the value decrease  button to select a different buzzer tone.



Main oven cooking information table

Food	Weight (Kg)	Function	Runner position from the bottom	Temperature (°C)	Time (minutes)	
Lasagne	3 - 4	Static	1	220 - 230	45 - 50	
Pasta bake	3 - 4	Static	1	220 - 230	45 - 50	
Roast veal	2	Turbo/Circulaire	2	180 - 190	90 - 100	
Pork	2	Turbo/Circulaire	2	180 - 190	70 - 80	
Sausages	1.5	Fan with grill	3	250/280	15	
Roast beef	1	Turbo/Circulaire	2	200	40 - 45	
Roast rabbit	1.5	Circulaire	2	180 - 190	70 - 80	
Turkey breast	3	Turbo/Circulaire	2	180 - 190	110 - 120	
Roast pork neck	2 - 3	Turbo/Circulaire	2	180 - 190	170 - 180	
Roast chicken	1.2	Turbo/Circulaire	2	180 - 190	65 - 70	
					1st surface	2nd surface
Pork chops	1.5	Fan with grill	3	250/280	15	5
Spare ribs	1.5	Fan with grill	3	250/280	10	10
Bacon	0.7	Grill	4	250/280	7	8
Pork fillet	1.5	Fan with grill	3	250/280	10	5
Beef fillet	1	Grill	4	250/280	10	7
Salmon trout	1.2	Turbo/Circulaire	2	160 - 170	35 - 40	
Monkfish	1.5	Turbo/Circulaire	2	160 - 170	60 - 65	
Turbot	1.5	Turbo/Circulaire	2	160 - 170	45 - 50	
Pizza	1	Fan assisted	2	250/280	8 - 10	
Bread	1	Circulaire	2	190 - 200	25 - 30	
Focaccia	1	Turbo/Circulaire	2	180 - 190	20 - 25	
Bundt cake	1	Circulaire	2	160	55 - 60	
Jam tart	1	Static	2	170	30 - 40	
Ricotta cake	1	Circulaire	2	160 - 170	55 - 60	
Jam tarts	1	Turbo/Circulaire	2	160	20 - 25	
Paradise cake	1.2	Circulaire	2	160	55 - 60	
Profiteroles	1.2	Turbo/Circulaire	2	180	80 - 90	
Sponge cake	1	Circulaire	2	150 - 160	55 - 60	
Rice pudding	1	Turbo/Circulaire	2	160	55 - 60	
Brioches	0.6	Circulaire	2	160	30 - 35	

The times indicated in the table do not include preheating times and are provided only as a guide.



Use

Auxiliary oven cooking information table

Food	Weight (Kg)	Function	Runner position from the bottom	Temperature (°C)	Time (minutes)	
					1 st surface	2 nd surface
Spit-roast chicken	1.2	Grill + rotisserie		220 - 250	70 - 80	
Rotisserie pork neck	2.5	Grill + rotisserie		200	200 - 220	
Roast rabbit	1	Static	2	190 - 200	85 - 90	
Roast chicken	1	Static	2	190 - 200	80 - 85	
Chops	0.8	Grill	4	250	13	5
Hamburgers	0.6	Grill	4	250	7	3
Pork sausages	0.6	Grill	4	250	15	-
Pork spare ribs	0.7	Grill	4	250	30 - 35	-
Bacon	0.6	Grill	4	250	10	3

The times indicated in the table do not include preheating times and are provided only as a guide.



4 Cleaning and maintenance

4.1 Instructions



Improper use Risk of damage to surfaces

- Do not use steam jets to clean the appliance.
- Do not use cleaning products containing chlorine, ammonia or bleach on steel parts or parts with metallic finishes on the surface (e.g. anodizing, nickel- or chromium-plating).
- Do not use abrasive or corrosive detergents on glass parts (e.g. powder products, stain removers and metallic sponges).
- Do not use rough or abrasive materials or sharp metal scrapers.
- Do not wash the removable components such as the hob grids, flame-spreader crowns and burner caps in a dishwasher.

4.2 Cleaning the appliance

To keep the surfaces in good condition, they should be cleaned regularly after use. Let them cool first.

Ordinary daily cleaning

Always use only specific products that do not contain abrasives or chlorine-based acids.

Pour the product onto a damp cloth and wipe the surface, rinse thoroughly and dry with a soft cloth or a microfibre cloth.

Food stains or residues

Do not use metallic sponges or sharp scrapers as they will damage the surfaces.

Use ordinary non-abrasive products with the aid of wooden or plastic utensils if necessary. Rinse thoroughly and dry with a soft cloth or a microfibre cloth.

Do not allow residues of sugary foods (such as jam) to set inside the oven. If left to set for too long, they might damage the enamel lining of the oven.

Cooking hob grids

Remove the grids and clean them with lukewarm water and non-abrasive detergent. Make sure to remove any encrustations. Dry them thoroughly and return them to the hob.



Continuous contact between the grids and the flame can cause modifications to the enamel over time in those parts exposed to heat. This is a completely natural phenomenon which has no effect on the operation of this component.

Flame-spreader crowns and burner caps

For easier cleaning, the flame-spreader crowns and the burner caps can be removed. Wash them in hot water and non-abrasive detergent. Carefully remove any encrustation, then wait until they are perfectly dry. Refit the flame-spreader crowns making sure that they are correctly positioned in their housings with their respective burner caps.



Cleaning and maintenance

Igniters and thermocouples

For correct operation the igniters and thermocouples must always be perfectly clean. Check them frequently and clean them with a damp cloth if necessary. Remove any dry residues with a wooden toothpick or a needle.

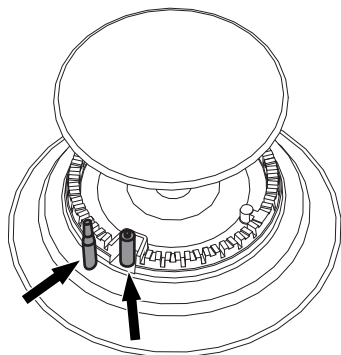

4.3 Removing the doors

For easier cleaning, the doors can be removed and placed on a tea towel or other protective sheet.

To remove the door proceed as follows:

1. Open the door completely and insert two pins into the holes on the hinges indicated in the figure.

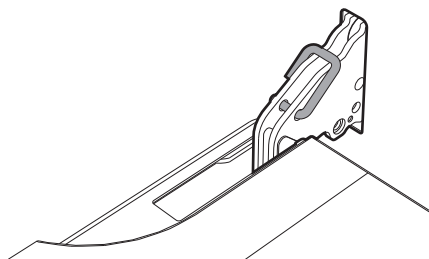

2. Grasp the door on both sides with both hands, lift it forming an angle of around 30° and remove it.

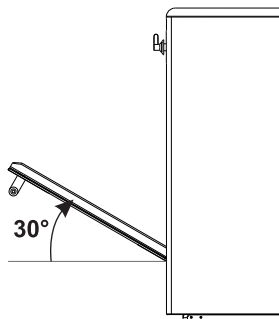

3. To reassemble the door, put the hinges in the relevant slots in the oven, making sure that grooved sections **A** are resting completely in the slots. Lower the door and once it is in place remove the pins from the holes in the hinges.

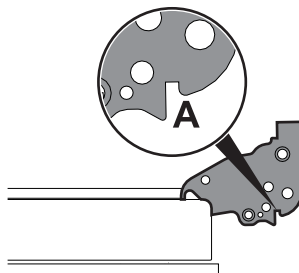



4.4 Cleaning the door glazing

The glass in the door should always be kept thoroughly clean. Use absorbent kitchen roll. In case of stubborn dirt, wash with a damp sponge and an ordinary detergent.



We recommend the use of cleaning products distributed by the manufacturer.

4.5 Cleaning the inside of the ovens

To keep the ovens in perfect condition, clean them regularly after allowing them to cool.

- Take out all removable parts.

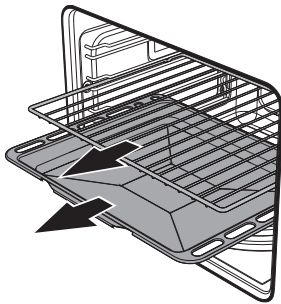

- Clean the oven racks with warm water and non-abrasive detergent. Carefully rinse and dry damp parts.



The ovens should be operated at the maximum temperature for about 15-20 minutes after using cleaning products, to burn off the residues left inside the oven.



For easier cleaning, remove the door.

4.6 Pyrolytic cycle



Pyrolytic is an automatic high-temperature cleaning procedure which causes dirt to dissolve. This process makes it possible to clean the inside of the oven very easily.



Improper use
Risk of damage to surfaces

- Remove any large amounts of food residues or spills from previous cooking operations from the inside of the oven.

Preliminary operations



Before starting the pyrolytic cycle:

- Clean the internal glass pane following the usual cleaning instructions.
- For very stubborn encrustations spray an oven cleaning product onto the glass (read the warnings on the product); leave for 60 minutes, then rinse and dry the glass using kitchen roll or a microfibre cloth.
- Completely remove all accessories from inside the oven cavity.
- Remove the rack/tray support frames.
- Close the door.



Cleaning and maintenance

Setting up the pyrolytic function

1. Turn the function knob to the **P** symbol.  Will appear on the display alternating with the minimum pyrolytic cycle time (2 hours).
2. Press the  or  button to set the duration of the cleaning cycle from a minimum of 2 hours to a maximum of 3 hours and 30 minutes.



Recommended pyrolytic cycle duration:

- Light dirt: 2 hours.
- Medium dirt: 2 hours 45 minutes.
- Heavy dirt: 3 hours 30 minutes.

3. Press the  button to confirm the start of the pyrolytic cycle.
4. One minute after the pyrolytic cycle has started, the door is locked (the door lock light lights up) by a device that prevents it from being opened.









It is not possible to select any function once the door lock device has been activated.

5. At the end of the pyrolytic cycle, all the numbers on the display will flash and a buzzer will sound to indicate the end of the automatic cleaning cycle.
6. Move the function knob back to the "0" position.

7. The door remains locked as long as the temperature inside the oven returns to safety levels.
8. Wait for the oven to cool down and collect the residues deposited inside with a damp microfibre cloth.

Setting of programmed pyrolytic cycle

It is possible to program the pyrolytic cycle start time like all other cooking functions.

1. After having started the pyrolysis cycle (see "Setting up the pyrolytic function"), press and hold the  button for 2 seconds.
2. Continue to press the  button until  appears on the display.
3. Press the  and  buttons within 5 seconds to set the time at which you want the cleaning cycle to end.
4. Press the  button to confirm the settings.



When setting the pyrolytic cycle, pay attention not to turn the function knob. In this case, data set through the timer is deleted and must be set again.



During the first pyrolytic cycle, unpleasant odours may occur due to the normal evaporation of oily manufacturing substances. This is an absolutely normal phenomenon which disappears after the first pyrolytic cycle.



During the pyrolytic cycle the fans produce a more intense level of noise due to a greater rotation speed. This is an absolutely normal operation, intended to provide more effective heat dispersal. At the end of the pyrolytic cycle, the fans will continue to operate for long enough to avoid overheating the walls of adjacent units and the front of the oven.

4.7 Extraordinary maintenance



Live parts
Danger of electrocution

- Disconnect the oven power supply.

Replacing the interior light bulb (main oven)

1. Completely remove all accessories from inside the oven.
2. Remove the racks/trays support frames.
3. Remove the bulb cover using a tool (e.g. a screwdriver).

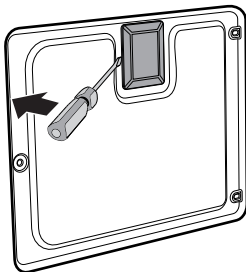

4. Slide out and remove the lamp.

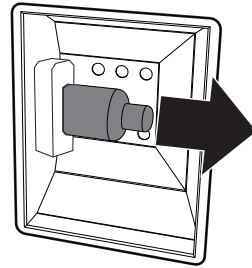

Do not touch the halogen lamp directly with your fingers, but wrap it in insulating material.

5. Replace the lamp with one of the same type (40W).
6. Refit the cover correctly, so that the moulded part of the glass is facing the door.
7. Press the cover completely down so that it attaches perfectly to the bulb support.

Replacing the interior light bulb (auxiliary oven)

1. Unscrew bulb protector **A** (turn anti-clockwise).
2. Replace bulb **B** with one of the same type (25W). Use only oven bulbs (T 300°C).

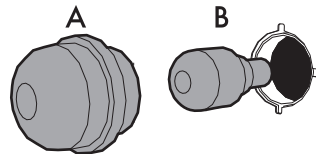

3. Re-fit bulb protector **A**.



Installation

5 Installation

5.1 Gas connection (not valid for the UK)



For installation in the UK, please refer to the "Local specifications for UK gas appliances installation" booklet.



Gas leak Danger of explosion

- After carrying out any operation, check that the tightening torque of gas connections is between 10 Nm and 15 Nm.
- If required, use a pressure regulator that complies with current regulations.
- At the end of the installation, check for any leaks with a soapy solution, never with a flame.
- Installation using a hose must be carried out so that the length of the piping does not exceed 2 metres when fully extended for steel hoses and 1.5 metres for rubber hoses.
- The hoses should not come into contact with moving parts and should not be crushed in any way.
- The adjustment conditions for this appliance are shown on the gas setting label.

General information

Connection to the gas mains can be made using a continuous wall steel hose in compliance with the guidelines established by the standards in force.

For supplying it with other types of gas, see chapter "5.2 Adaptation to different types of gas". The gas inlet connection is threaded 1/2" external gas (ISO 228-1).

Connection with a rubber hose

Verify that all following conditions are met:

- the hose is fixed to the hose connection with safety clamps;
- no part of the hose is in contact with hot walls (max. 50 °C);
- the hose is not under traction or tension and has no kinks or twists;
- the hose is not in contact with sharp objects or sharp corners;
- if the hose is not perfectly airtight and leaks gas, do not try to repair it; replace it with a new hose.
- verify that the hose is not past its expiry date (serigraphed on the hose itself).

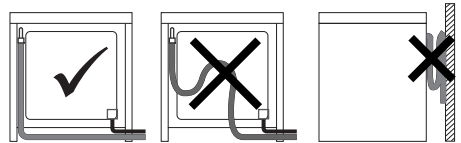

Make the connection to the gas mains using a rubber hose whose specifications comply with current standards (verify that the reference standard is stamped on the hose).



Carefully screw hose connector **3** to the appliance's gas connector **1** ($\frac{1}{2}$ " ISO 228-1 thread), placing seal **2** between them. Hose connector **4** can also be screwed to hose connector **3**, depending on the diameter of the gas hose used. After tightening the hose connector(s), push gas hose **6** onto the hose connector and secure it with clamp **5** (which must be compliant with the applicable standard).

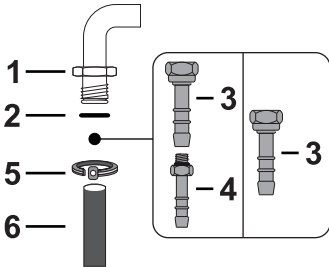

Connection using a rubber hose complying with current standards is only permitted if the hose can be inspected along its entire length.



The inside diameter of the hose must be 8 mm for LPG and 13 mm for Natural gas and City gas.

Connection to LPG

Use a pressure regulator and make the connection on the gas cylinder following the guidelines set out in the standards in force.

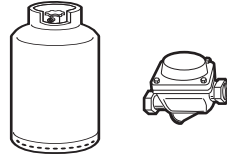

The supply pressure must comply with the values indicated in the table in "Gas types and Countries".

Connection with a steel hose

Make the connection to the gas mains using a continuous wall steel hose whose specifications comply with the applicable standard.

Carefully screw the connector **3** to the gas connector **1** of the appliance, placing the seal **2** between them.

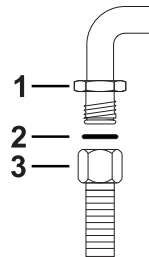



Installation

Connection with a steel hose with bayonet fitting

Carry out the connection to the gas mains using a steel hose with bayonet fitting compliant with B.S. 669. Apply insulating material to the thread of the gas hose connector **4** and then tighten the adapter **3**. Screw the assembly to the movable connector **1** of the appliance, placing the supplied seal **2** between them.

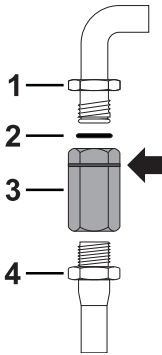

Carefully screw the hose connector **3** to the appliance's gas connector **1** ($\frac{1}{2}$ " thread ISO 228-1), placing the supplied seal **2** between them. Apply insulating material to the thread of connector **3**, then tighten the steel hose **4** to the connector **3**.

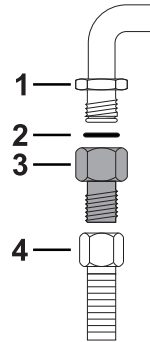

Connection with a steel hose with conical fitting

Make the connection to the gas mains using a continuous wall steel hose whose specifications comply with the applicable standard.

Room ventilation

The appliance should be installed in rooms that have a permanent air supply in accordance with the standards in force. The room where the appliance is installed must have enough air flow for the regular combustion of gas and the necessary air change in the room itself. The air vents, protected by grilles, must be the right size to comply with current regulations and positioned so that no part of them is obstructed, not even partially.

The room must be kept adequately ventilated in order to eliminate the heat and humidity produced by cooking: In particular, after prolonged use, you are recommended to open a window or to increase the speed of any fans.



Extraction of the combustion products



This appliance is not connected to an exhaust system for combustion products. It must be installed and connected in compliance with the current installation regulations. Special attention should be paid to the relevant requirements as for ventilation.

The combustion products may be extracted by means of hoods connected to a natural draught chimney whose efficiency is certain or via forced extraction. An efficient extraction system requires precision planning by a specialist qualified in this area and must comply with the positions and clearances indicated by the applicable standards.

When the job is complete, the installer must issue a certificate of conformity.

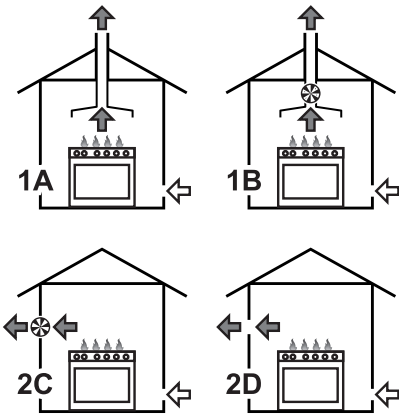

- 1 Extraction using a hood
- 2 Extraction without a hood
- A Single natural draught chimney
- B Single chimney with extractor fan
- C Directly outdoors with wall- or window-mounted extractor fan
- D Directly outdoors through wall

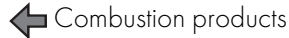

5.2 Adaptation to different types of gas

In case of operation with other types of gas, the burner nozzles must be changed and the minimum flame adjusted on the gas taps.

Replacing nozzles

1. Remove the grids, burner caps and flame-spreader crowns to access the burner casings.
2. Replace the nozzles using a 7 mm spanner according to the gas to be used (see Burner and nozzle characteristics tables).

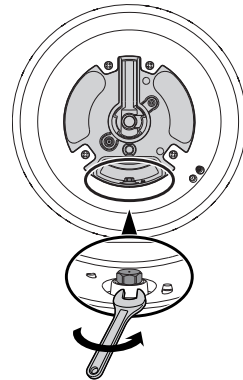



Installation

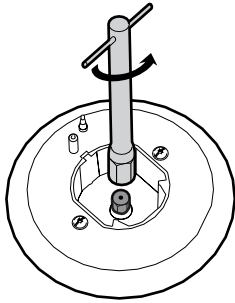

3. Reposition the burners in their correct seats.

Adjusting the minimum setting for natural or city gas

Light the burner and turn it to the minimum position. Extract the gas tap knob and turn the adjustment screw next to the tap rod (depending on the model) until the correct minimum flame is achieved.

Refit the knob and verify that the burner flame is stable. Turn the knob rapidly from the maximum to the minimum setting: The flame should not go out. Repeat the operation on all gas taps.

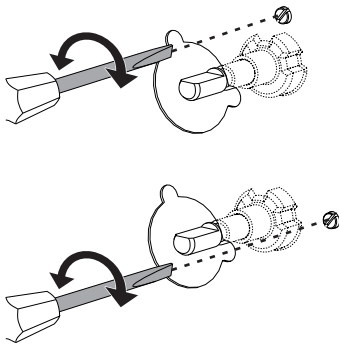

Adjusting the minimum setting for LPG

Tighten the screw located at the side of the tap rod clockwise all the way.



Following adjustment to a gas other than the one originally set in the factory, replace the gas setting label on the appliance with the one corresponding to the new gas. The label is inserted inside the nozzle pack (where present).

Lubricating the gas taps

Over time the gas taps may become difficult to turn and get blocked. Clean them internally and replace the grease.



Lubrication of the gas taps should be performed by a specialised technician.



Gas types and Countries

Gas types		IT	GB-IE	FR-BE	DE	AT	NL	ES	PT	SE	RU	DK	PL	HU
1 Natural gas G20														
G20	20 mbar	•	•		•	•		•	•	•	•	•	•	
G20/25	20/25 mbar			•										
2 Natural gas G20														
G20	25 mbar													•
3 Natural gas G25														
G25	25 mbar						•							
4 Natural gas G25.1														
G25.1	25 mbar													•
5 Natural gas G25														
G25	20 mbar				•									
6 Natural gas G2.350														
G2.350	13 mbar												•	
7 LPG G30/31														
G30/31	28/37 mbar		•	•				•			•			
G30/31	30/37 mbar	•							•					
G30/31	30/30 mbar						•			•		•		
8 LPG G30/31														
G30/31	37 mbar													•
9 LPG G30/31														
G30/31	50 mbar				•	•								
10 Town gas G110														
G110	8 mbar	•								•		•		



Installation

Burner and nozzle characteristics tables

1 Natural gas G20 – 20 mbar	AUX	SR	R	UR2
Rated heating capacity (kW)	1.0	1.8	3.0	4.2
Nozzle diameter (1/100 mm)	72	97	115	155
Pre-chamber (printed on nozzle)	(X)	(Z)	(Y)	(H3)
Reduced flow rate (W)	400	500	800	1400
2 Natural gas G20 – 25 mbar	AUX	SR	R	UR2
Rated heating capacity (kW)	1.1	1.8	3.0	4.2
Nozzle diameter (1/100 mm)	72	94	110	145
Pre-chamber (printed on nozzle)	(X)	(Z)	(H8)	(H3)
Reduced flow rate (W)	400	500	800	1400
3 Natural gas G25/G25.3 – 25 mbar	AUX	SR	R	UR2
Rated heating capacity (kW)	1.0	1.8	3.0	4.2
Nozzle diameter (1/100 mm)	72	94	121	148
Pre-chamber (printed on nozzle)	(F1)	(Y)	(F2)	(F3)
Reduced flow rate (W)	400	500	800	1400
4 Natural gas G25.1 – 25 mbar	AUX	SR	R	UR2
Rated heating capacity (kW)	1.10	1.8	3.0	4.2
Nozzle diameter (1/100 mm)	77	100	134	152
Pre-chamber (printed on nozzle)	(F1)	(Y)	(F3)	(F3)
Reduced flow rate (W)	400	500	800	1400
5 Natural gas G25 – 20 mbar	AUX	SR	R	UR2
Rated heating capacity (kW)	1.0	1.8	3.0	4.0
Nozzle diameter (1/100 mm)	77	100	134	165
Pre-chamber (printed on nozzle)	(F1)	(Y)	(F3)	(H3)
Reduced flow rate (W)	400	500	800	1400
6 Natural gas G2.350 – 13 mbar	AUX	SR	R	UR2
Rated heating capacity (kW)	1.0	1.8	3.0	4.0
Nozzle diameter (1/100 mm)	94	120	165	190
Pre-chamber (printed on nozzle)	(Y)	(Y)	(F3)	(F3)
Reduced flow rate (W)	400	500	800	1400

Installation



EN

7 Liquid gas – G30/31 - 30/37 mbar	AUX	SR	R	UR2
Rated heating capacity (kW)	1.0	1.8	3.0	4.0
Nozzle diameter (1/100 mm)	50	65	85	100
Pre-chamber (printed on nozzle)	-	-	-	-
Reduced flow rate (W)	400	500	800	1400
Rated flow rate G30 (g/h)	73	131	218	291
Rated flow rate G31 (g/h)	71	129	214	286
8 LPG G30/31 - 37 mbar	AUX	SR	R	UR2
Rated heating capacity (kW)	1.10	1.9	3.0	4.2
Nozzle diameter (1/100 mm)	50	65	81	95
Pre-chamber (printed on nozzle)	-	-	-	-
Reduced flow rate (W)	450	550	800	1500
Rated flow rate G30 (g/h)	80	138	218	305
Rated flow rate G31 (g/h)	79	136	214	300
9 LPG G30/31 - 50 mbar	AUX	SR	R	UR2
Rated heating capacity (kW)	1.0	1.8	3.0	4.1
Nozzle diameter (1/100 mm)	43	58	74	80
Pre-chamber (printed on nozzle)	(H2)	(M)	(Z)	(F4)
Reduced flow rate (W)	400	500	800	1500
Rated flow rate G30 (g/h)	73	131	218	298
Rated flow rate G31 (g/h)	71	129	214	293
10 Town gas G110 – 8 mbar	AUX	SR	R	UR2
Rated heating capacity (kW)	1.0	1.8	2.9	3.6
Nozzle diameter (1/100 mm)	145	185	260	340
Pre-chamber (printed on nozzle)	/8	/2	/3	-
Reduced flow rate (W)	400	500	800	1200

The nozzles not provided are available at Authorised Service Centres.



Installation

5.3 Electrical connection



**Power voltage
Danger of electrocution**

- Have the electrical connection performed by authorised technical personnel.
- Use personal protective equipment.
- The appliance must be connected to ground in compliance with electrical system safety standards.
- Disconnect the main power supply.
- Do not pull the cable to remove the plug.
- Use cables withstanding a temperature of at least 90°C.
- The tightening torque of the screws of the terminal supply wires must be 1.5 - 2 Nm.

General information

Check the grid characteristics against the data indicated on the plate.

The identification plate bearing the technical data, serial number and brand name is visibly positioned on the appliance.

Do not remove this plate for any reason.

Perform the ground connection using a wire that is 20 mm longer than the other wires.

The appliance can work in the following modes:

- **220-240 V 2~**

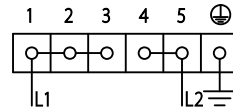

- **3 x 2.5 mm² three-core cable.**

- **220-240 V 3~**

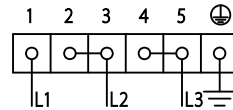

- **4 x 1.5 mm² four-core cable.**

- **220-240 V 1N~**

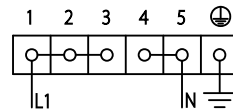

- **3 x 2.5 mm² three-core cable.**

- **380-415 V 2N~**

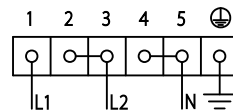

- **4 x 1.5 mm² four-core cable.**

- **380-415 V 3N~**

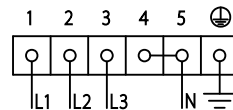

- **5 x 1.5 mm² five-core cable.**



The values indicated above refer to the cross-section of the internal conductor.



The aforementioned power cables are sized taking into account the coincidence factor (in compliance with standard EN 60335-2-6).

Access to the terminal board

To connect the power supply cable, you must access the terminal board on the rear casing:

1. Remove the screws fastening the plate to the rear casing.

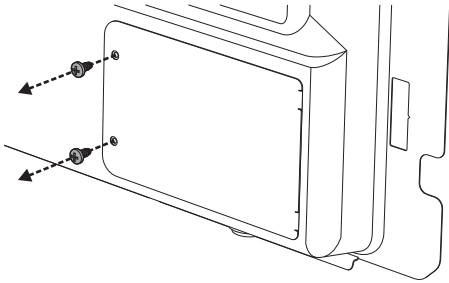

2. Gently rotate the plate and remove it from its seat.

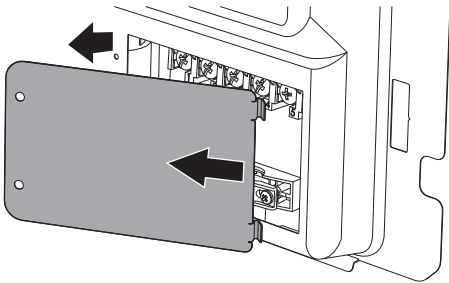

3. Proceed with installation of the power supply cable.

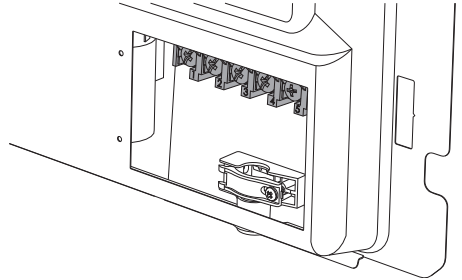

It is recommended to slacken off the cable clamp screw before installing the power supply cable.

4. When you have finished, reposition the plate on the rear casing and fasten it in place with the previously removed screws.

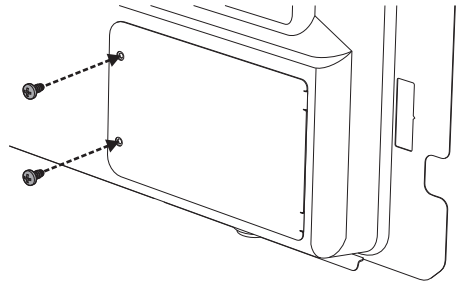

Fixed connection

Fit the power line with an omnipolar circuit breaker in compliance with installation regulations.

The circuit breaker should be located near the appliance and in an easily reachable position.



Installation

Connection with plug and socket

Make sure that the plug and socket are of the same type.

Avoid using adapters and shunts as these could cause overheating and a risk of burns.

5.4 Positioning



Heavy appliance
Danger of crushing injuries

- Position the appliance into the cabinet cutout with the help of a second person.



Pressure on the open door
Risk of damages to the appliance

- Never use the oven door to lever the appliance into place when fitting.
- Avoid exerting too much pressure on the oven door when open.



Heat production during appliance operation
Risk of fire

- Veneers, adhesives or plastic coatings on adjacent furniture should be temperature-resistant (no less than 90°C).

General information

This appliance may be installed next to walls, one of which must be higher than the worktop, at a minimum distance of 150 mm from the side of the appliance, as shown in figures A and C relative to the installation classes.

Any wall units positioned above the worktop must be at a minimum distance of at least 750 mm.

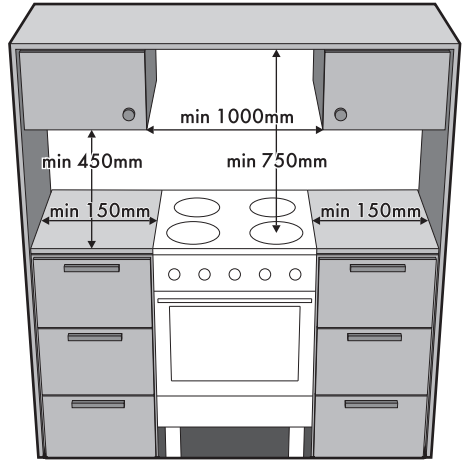

If a hood is installed above the hob, refer to the hood instruction manual to ensure the correct clearance is left.

Dimensions

Position of gas and electrical connections (all measurements expressed in mm).

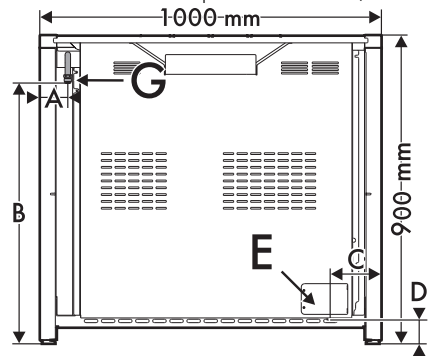

A	68 mm
B	610 mm
C	129 mm
D	32 mm



Depending on the type of installation, this appliance belongs to classes:

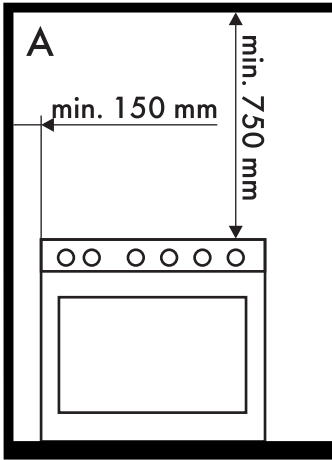

A - Class 1
(Free-standing appliance)

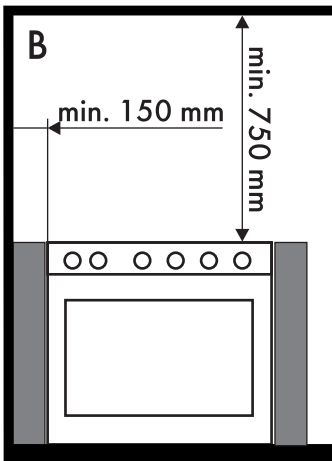

B - Class 2 subclass 1
(Built-in appliance)

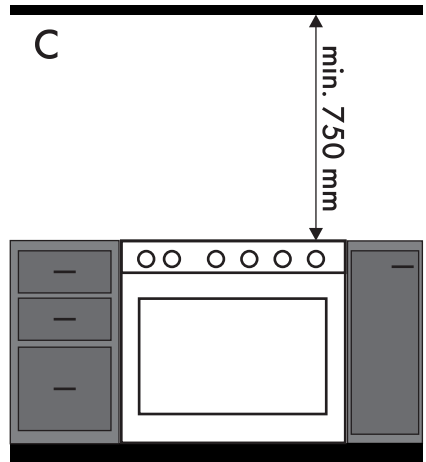

C - Class 2 subclass 1
(Built-in appliance)



The appliance must be installed by a qualified technician and according to the regulations in force.

Fastening to wall (where present)



Heavy appliance
Risk of damages to the appliance

- Insert the front feet first and then the rear ones.

The fastening system provided must be installed to ensure the appliance is stable. If installed correctly, this system prevents the appliance from tipping over.



Installation

1. Use the adjustable feet to level the appliance until it is level and stable on the ground.

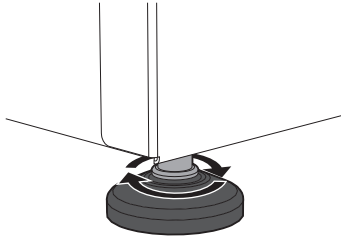

5. Connect the snap hook to the appropriate hole on the back of the appliance.

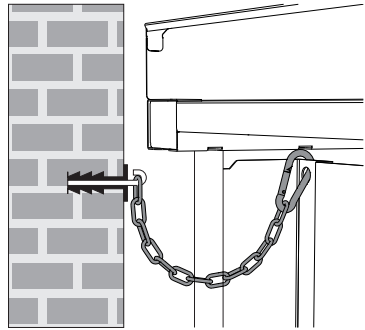

2. Fasten a hook bolt (not supplied) into the wall at a height (**H**) of **800 mm** from the floor.

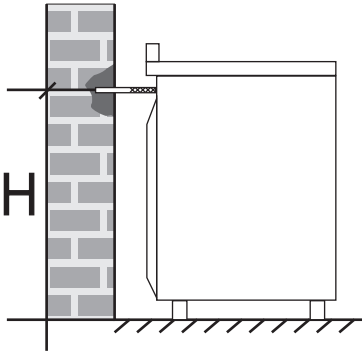

Assembling the upstand



The upstand should only be installed if the appliance is wall mounted.



The upstand provided is an integral part of the product; it must be fastened to the appliance prior to installation.

3. Attach the snap hook to the chain

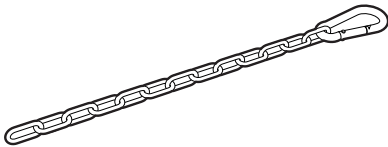

The upstand must always be positioned and secured correctly on the appliance.

1. Position the upstand on the top, taking care to line up holes **A** with holes **B**.

4. Attach the end of the chain to the hook bolt fastened in the wall.

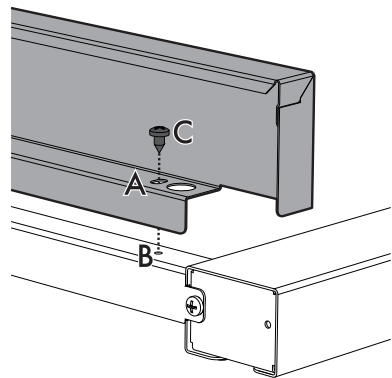



2. Secure the upstand to the top by tightening screws **C**.

Installing the grilled strip



The strip should only be installed if the appliance is installed as an island.

If the appliance is installed as an island, the strip provided should be installed instead of the upstand.

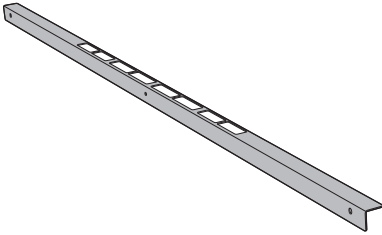

Use the 3 screws, provided, to secure the strip to the hob. Fasten it using the middle screw **(1)** first and then the side screws **(2)**.

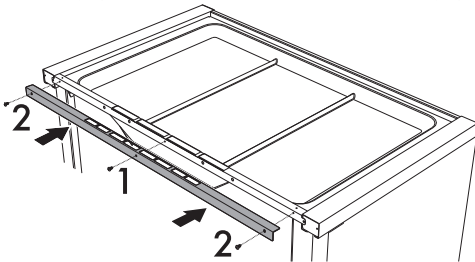

Keep a minimum clearance of 150 mm between the appliance and the other furnishings or decorative elements according to the diagram below.

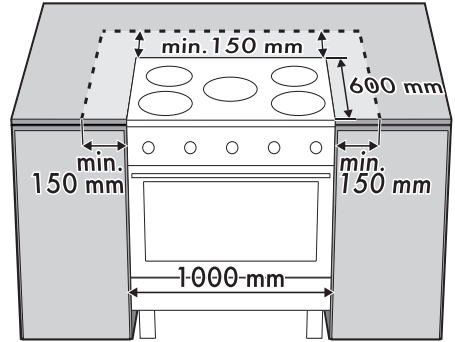

Improper use

Risk of damage to the appliance

- Be careful not to allow any solids or liquids to enter the slots in the grille strip.

Any wall units positioned above the worktop must be at a minimum distance of at least 750 mm. If a hood is installed above the appliance, refer to the hood instructions manual to make sure the correct clearance is left.



Installation

Positioning and levelling the appliance

After making the electrical and/or gas connections, properly level the appliance on the floor to ensure better stability. Screw or unscrew the bottom part of the foot until the appliance is stable and level on the floor.

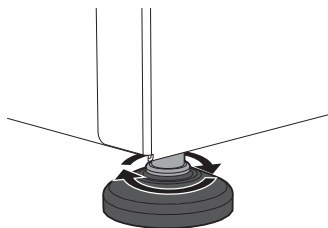

5.5 Instructions for the installer

- The plug must be accessible after installation. Do not bend or trap the power cable.
- The appliance must be installed according to the installation diagrams.
- Do not try to unscrew or force the threaded elbow of the fitting. You may damage this part of the appliance, which may void the manufacturer's warranty.
- Use soap and water to check for gas leaks on all connections. **DO NOT** use naked flames to find leaks.
- Turn on all the burners separately and at then all together to make sure that the gas valve, burner and ignition are working properly.
- Turn the burner knobs to the minimum position and check that the flame is stable for each individual burner and all the burners together.
- If the appliance does not work correctly after having carried out all the checks, contact your local Authorised Service Centre.
- Once the appliance has been installed, please explain to the user how to use it correctly.