

**Hisense**

life reimagined

EN

GB

IE

# **INSTRUCTIONS FOR USE**

## **BUILT-IN OVEN**

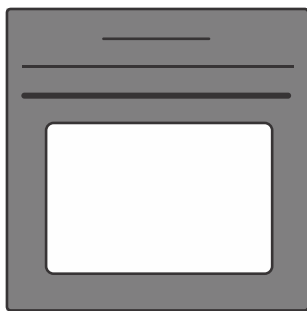

We thank you for your trust and the purchase of our appliance.

This detailed instruction manual is supplied to make the use of this product easier. The instructions should allow you to learn about your new appliance as quickly as possible.

Make sure you have received an undamaged appliance. If you do find transport damage, please contact the seller from which you purchased the appliance, or the regional warehouse from which it was supplied. The telephone number can be found on the invoice or on the delivery note.

Instructions for installation and connection are supplied on a separate sheet.

The following symbols are used throughout the manual and they have the following meanings:



**INFORMATION!**

Information, advice, tip, or recommendation



**WARNING!**

Warning – general danger



It is important that you carefully read the instructions.

# Contents

<b>1. Safety precautions</b> .....	<b>4</b>
1.1 Safe and correct use of the oven during pyrolytic cleaning .....	5
<b>2. Other important safety warnings</b> .....	<b>6</b>
<b>3. Appliance description</b> .....	<b>8</b>
3.1 Appliance equipment .....	8
3.2 Control panel .....	9
<b>4. Before first use</b> .....	<b>10</b>
4.1 Switching on for the first time .....	10
<b>5. Using the oven – selecting the baking settings</b> .....	<b>12</b>
5.1 Professional baking mode .....	13
5.2 Time functions .....	15
5.3 Step bake .....	16
5.4 Steam injection during the baking process .....	17
5.5 Automatic cooking mode .....	19
5.6 Automatic programs .....	20
5.7 Additional functions .....	22
<b>6. Starting the cooking process</b> .....	<b>23</b>
6.1 Additional browning – au gratin .....	23
<b>7. End of cooking by touching</b> .....	<b>23</b>
<b>8. General settings</b> .....	<b>25</b>
8.1 Locking keys .....	27
<b>9. ConnectLife and connectivity (Wi-Fi)</b> .....	<b>28</b>
9.1 Connecting the appliance to a mobile device .....	28
9.2 Wi-Fi module settings .....	28
<b>10. General tips and advice for baking</b> .....	<b>31</b>
10.1 Cooking table .....	32
10.2 Cooking with a Temperature Probe .....	36
<b>11. Cleaning and maintenance</b> .....	<b>39</b>
11.1 Automatic oven cleaning – pyrolysis .....	39
11.2 Cleaning the evaporator tray .....	41
11.3 Cleaning the steam system .....	42
11.4 Removing wire and fixed pull-out (extendible) guides .....	43
11.5 Removing and replacing the oven door and glass panes .....	43
11.6 Replacing the bulb .....	44
<b>12. Troubleshooting</b> .....	<b>45</b>
12.1 Troubleshooting table .....	45
12.2 Label – appliance information .....	46
<b>13. Compliance information</b> .....	<b>46</b>
<b>14. Environment protection</b> .....	<b>47</b>
<b>15. Cooking test</b> .....	<b>48</b>

# 1. Safety precautions

## **IMPORTANT SAFETY PRECAUTIONS – CAREFULLY READ THE INSTRUCTIONS AND SAVE THEM FOR FUTURE REFERENCE.**

The appliance may only be connected to the power mains by an authorized service technician or expert. Tampering with the appliance or nonprofessional repair thereof may result in risk of severe injury or damage to the product.

Appliance must be connected to fixed wiring which has incorporated means of disconnection. Fixed wiring must be made in accordance with the wiring rules.

The appliance must not be installed behind a decorative door in order to avoid overheating.

If the supply cord is damaged, it must be replaced by the manufacturer, its service agent or similarly qualified persons in order to avoid a hazard (only for appliances supplied with connection cord).

This appliance can be used by children aged 8 years and above, and by persons with reduced physical, sensory or mental capabilities or lack of experience and knowledge, if they have been given supervision or instruction concerning the use of the appliance in a safe way, and if they understand the hazards involved. Children shall not play with the appliance. Cleaning and user maintenance shall not be done by children without supervision.

**WARNING:** Accessible parts may become hot during use. Young children should be kept away.

**WARNING:** The appliance and some of its accessible parts may become very hot during use. Care should be taken to avoid touching heating elements. Children less than 8 years of age shall be kept away unless continuously supervised.

The appliance is not intended to be controlled by external timers or separate remote control system.

Only use the temperature probe recommended for use in this oven.

Do not use harsh abrasive cleaners or sharp metal scrapers to clean the oven door glass/ the glass of hinged lids of the hob (as appropriate), since they can scratch the surface, which may result in shattering of the glass.

Do not use steam cleaners or high-pressure cleaners to clean the appliance as this may result in an electric shock.

**WARNING:** Before replacing the light bulb, make sure the appliance has been disconnected from the mains power, in order to prevent the hazard of an electric shock.

Never pour water directly on the bottom of the oven cavity. Temperature differences could result in damage to the enamel coating.

### **1.1 Safe and correct use of the oven during pyrolytic cleaning**

During the automatic cleaning process, the oven heats up to a very high temperature and it is very hot on the outside as well. Risk of burns! Keep children away from the oven.

## 2. Other important safety warnings

The appliance is intended for household use. Do not use it for any other purpose, such as room heating, drying of pets or other animals, paper, fabrics, herbs etc. As this may lead to injury or fire hazard.

The appliance may only be connected to the power mains by an authorized service technician or expert. Tampering with the appliance or nonprofessional repair thereof may result in risk of severe injury or damage to the product.

We recommend that (due to appliance weight) at least two persons carry and install the appliance.

Do not lift the appliance by holding it by the door handle.

Oven door hinges may be damaged when under excessive load. Do not stand or sit on the open oven door, and do not lean against it. Also, do not place any heavy objects onto the oven door.

If the power cords of other appliances located in the vicinity of the oven become entangled in the oven door, they may get damaged, which may cause a short circuit. Therefore, make sure that the power cords of other appliances are at a safe distance.

Make sure the vents are never covered or obstructed in any other way.

Do not line the oven walls with aluminium foil and do not place baking trays or other containers on the bottom of the oven. This would reduce air circulation in the oven, obstruct and slow down the baking process and destroy the enamel coating.

We recommend you avoid opening the oven door during baking, as this increases power consumption and condensate accumulation.

At the end of the baking process, and during baking, be careful when opening the oven door, as there is danger of scalding.

To prevent limescale accumulation, leave the oven door open after baking or using the oven, to allow the oven cavity to cool down to room temperature.

Clean the oven when it has completely cooled down.

Eventual mismatches in colour shades between different appliances or components within a single design line may occur due to various factors, such as different angles under which the appliances are observed, different coloured backgrounds, materials, and room illumination.

Do not use the appliance if it is damaged. Unplug the appliance from the power mains and call an authorized service centre.

The oven can be safely used with or without baking pan guides.

Do not store items in the oven, which could cause danger when the oven is switched on.

Before you activate automatic cleaning, carefully read and observe all instructions in the chapter Cleaning and Maintenance, which describes correct and safe use of this function

Do not place anything on the oven bottom during the automatic cleaning process.

Risk of fire! During automatic cleaning, the appliance is heated to very high temperatures, which will incinerate food residues in the appliance. Therefore, remove visible dirt from the inside of the oven and from the utensils before each use. Smoke, irritating fumes and gases may also come from the oven while the cleaning function is active. Therefore, make sure that the room is well-ventilated while you carry out this procedure. Small animals or pets can be very sensitive to any fumes that might come out from the oven. It is recommended to remove them from the room during operation and to ventilate the room well after cleaning.

Do not open the oven door during cleaning.

Make sure no foreign objects enter the opening for locking the door guide, as this could block automatic door locking during the oven cleaning process.

Do not touch any metal surfaces or parts of the appliance during the automatic cleaning process!

In case of a power outage during the automatic cleaning process, the program will be terminated after two minutes and the oven door will remain locked. The door will be unlocked, when the appliance senses that the temperature has dropped to below 150 °C in the centre of the oven cavity.

After the self-cleaning process, the oven cavity and the oven accessories can discolour and lose their sheen. This does not affect their functionality.



**WARNING!**

**Using the oven with the door open and the door switch closed is not permitted.**

Before connecting the appliance to the power mains, leave it at room temperature for some time to allow all components to adapt to room temperature. If the oven was stored at a temperature close to freezing point or below it, this could be hazardous to some components, particularly the pump.

Do not operate the appliance in an environment colder than 5 °C. If the appliance is switched on in such conditions, the pump could be damaged.

Do not use distilled water, tap water with high chlorine content, or other similar liquids.

When baking with steam injection, always fully open the oven door when the baking process is completed. If you do not do so, the steam rising from the oven cavity could affect the operation of the control unit.

Peel off the adhesive tape from the control unit after installing the appliance into the cabinet. Failure to do so may result in a tank failure.

Only place the evaporating dish in the appliance when baking with a steam injection. When not using the steam injection function, remove it.

Only remove and replace the evaporating tray when the oven has completely cooled down.



**WARNING!**

**Carefully read the instructions for use before connecting the appliance. Repair or any warranty claim resulting from incorrect connection or use of the appliance shall not be covered by the warranty.**

## 3. Appliance description



**WARNING!**

Appliance functions and equipment depend on the model.

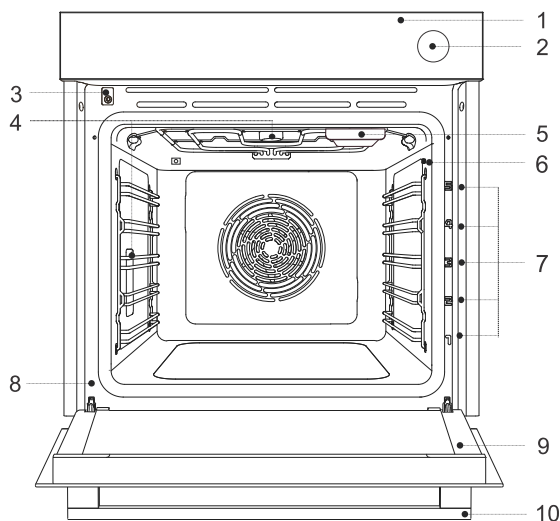

1. Control panel
2. Water tank button
3. Locking the door with a switch
4. Lighting
5. Evaporator tray
6. Food probe socket
7. Guides – rack levels
8. Label
9. Oven door
10. Door handle

### 3.1 Appliance equipment

#### Oven door switch

The switch switches off the operation of the heaters and the ventilation in the oven room when the oven door is opened during operation.

#### Guides

**Wire guides** – always insert the wire rack and baking tray into the guide.

**Fixed pull-out guides** – place the equipment on the guide. On the same guide, you can place the rack together with the drip pan.

NOTE: Equipment insertion guides are counted from the bottom up.

#### Oven equipment and accessories

1. **Wire rack** – used for grilling/broiling or as support for a pan, baking tray or baking dish.

NOTE: When inserting the wire rack into the guide, always make sure its elevated part is at the back and on the top side.

There is a safety latch on the wire rack. Therefore, the wire rack has to be lifted slightly at the front when pulling it out from the oven.

2. **Shallow baking tray** – used for flatbreads and small cakes. It can also be used as a drip tray.

NOTE: A shallow baking tray may become deformed when heated in the oven. When it cools down, it returns to its original state. The deformation does not affect its functionality.

3. **Mesh tray Airfry** – (baking tray with holes) used for cooking with systems that feature steam injection and for air frying. The holes allow for better air flow around the food and contribute to greater crispness. When cooking food with a higher liquid content (water, fat), insert a shallow or deep universal baking tray one rack lower.

4. **Deep all-purpose baking tray** – used for baking vegetables and moist pastries. It can also be used as a drip tray.

NOTE: Never insert the deep all-purpose (or universal) baking tray into the first guide when baking.



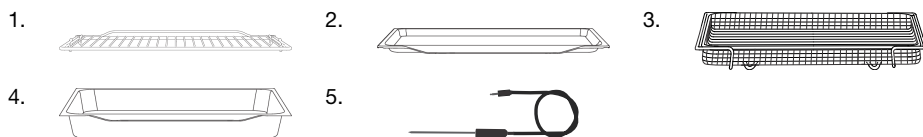



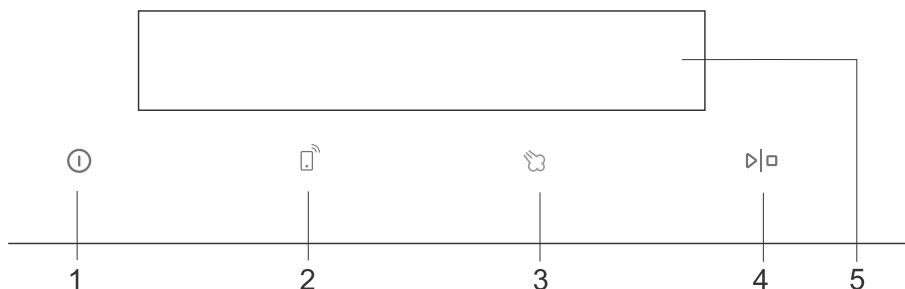

5. Temperature probe for meat - (BAKESENSOR)



## 3.2 Control panel



Key	Use
1	Switching the oven on and off
2	Connection setup (Wi-Fi)
3	Addition of steam
4	Starting and stopping Confirming a setting
5	Display of current settings in the oven. Illuminated part of the line - displays the currently selected field from A to E. Arrow - displays the selected basic setting (pro bake), (auto bake), (extra bake).

Explanation of shortcuts in the manual:			
	 4 s		
<b>Briefly touch the key</b> – to confirm the setting.	<b>Press and hold the key (4 sec.)</b> – for additional settings.	<b>Rotate the button</b> – to switch between settings and select settings.	<b>Press the button</b> – to confirm your selection.
			
First step	Intermediate step	Passed time (exp. oven is operational)	Optional step
 <b>INFORMATION!</b> For better key responsiveness, touch them with a large area of your fingertip. Each time you press a key, this will be acknowledged by an acoustic signal (when this function is available).			

## 4. Before first use

1.	Remove oven accessories and any packaging (cardboard, polystyrene foam) from the oven.
2.	Wipe the oven accessories and interior with a damp cloth. Do not use abrasive or aggressive cloths or cleaners.
3.	Turn on the oven (see chap. 4.1 <i>Switching on for the first time</i> )
4.	Preheat the oven to 250 °C for approximately one hour using the top and bottom heater system (see chapter Professional baking mode).
NOTE: During heating, the characteristic "new smell" is released, so ventilate the room thoroughly during this time.	

### 4.1 Switching on for the first time

After connecting your appliance or after an extended power outage, 12:00 will flash on the display.

First select and confirm the basic settings below (exact time, beep volume and display illumination).

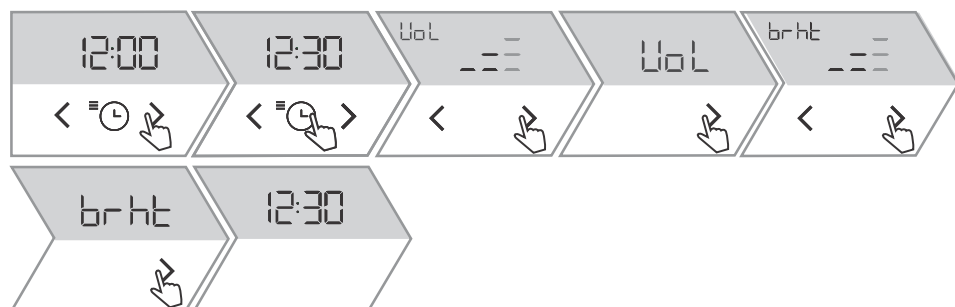

1.		With the key < or > set the exact time of day. Confirm your selection with  .
2.		The display will show <b>Vol</b> . With the key < or > increase or decrease the volume of beeps.
3.		When you touch > the display will show <b>brht</b> . With the key < or > increase or decrease the intensity of the display illumination.
4.		To exit the basic settings, touch > .

### Testing water hardness

Cleaning of the steam system depends on both frequency of baking with steam injection and on the hardness of the water used.

Soak the test paper strip (supplied with the appliance) in water for one (1) second. Wait one minute, then note the number of stripes on the paper (see chapter 8. *General settings*):

4 green stripes - Hrd 1	1 red stripe - Hrd 2	2 red stripes - Hrd 3
3 red stripes - Hrd 4	4 red stripes - Hrd 5	

## 5. Using the oven – selecting the baking settings

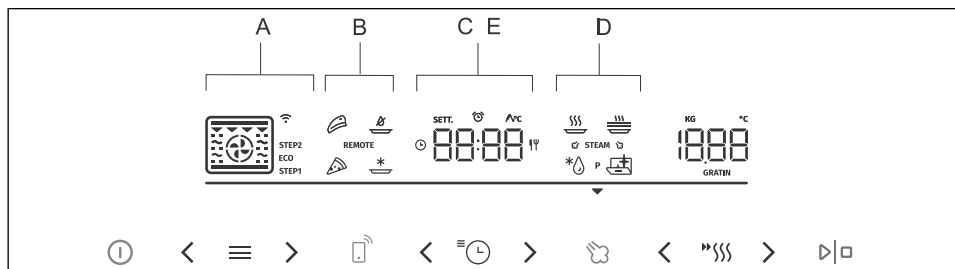

Key	Use
<	Left selector key
≡	Baking selection key. By touching the key, you can select:
Pr □	<b>A</b> Professional mode <b>Pro</b> – allows you to set the baking parameters (baking system, temperature, quick preheating, and baking time) at your discretion.
Auto	<b>B</b> Automatic mode <b>Auto</b> – special preset programmes which you can also change.
Pr □□	<b>C</b> Automatic programmes <b>ProG</b> (Pr01 to Pr22)
Other	<b>D</b> Dodatne funkcije <b>Othr</b>
SEtt	<b>E</b> General settings <b>SEtt</b>
>	Right selector key
⌚	Key for setting time functions and general settings
»)))	Key for setting the quick preheat function and gratin function

NOTE: The display only illuminates the keys that can be used to set and confirm the selected setting.

Symbol	Meaning
□	Baking systems
WiFi	WiFi connection
REMOTE	Turning on the oven's remote control
STEP1	Baking by steps (STEP1, STEP2)
⌚	Time function – baking time
⌚	Time function – delayed end
🕒	Egg timer
Avc	Temperature probe for meat
☁ STEAM ☁	STEAM function to add steam during baking.
»)))	Fast preheat
GRATIN	GRATIN function for extra top crust at the end of baking.

NOTE: Some symbols on the display appear as slightly illuminated (the function is in standby mode). If you press the key to select a symbol and confirm it, the symbol's intensity will increase. This is when the function is active.

## 5.1 Professional baking mode

This function allows setting the baking parameters – baking system, temperature, fast preheating, and baking time – freely, at the user's discretion.

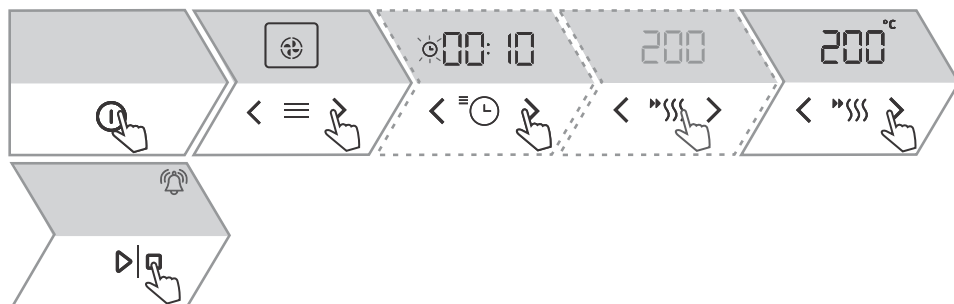











1.	Turn on the oven. For a few seconds, the display will show <b>Pro</b> , and then the oven settings that have been overridden are displayed.
2.	With the key < or > set the baking system (see table Selection of baking systems) and temperature.
3.	Use quick preheating to bring the oven to the desired temperature as quickly as possible. When you touch "⋮⋮⋮", the symbol lights up. When the set temperature is reached, an acoustic signal sounds. The display will show <b>door</b> . Open the door and insert the dish. The programme automatically resumes baking with the selected settings.
4.	Additionally, you can set: <ul style="list-style-type: none"> <li>- time functions (see chapter 5.2 <i>Time functions</i>)</li> <li>- baking by steps (see chapter 5.3 <i>Step bake</i>)</li> <li>- gratin function (see chapter 6.1 <i>Additional browning – au gratin</i>)</li> <li>- addition of steam (see chapter 5.4 <i>Steam injection during the baking process</i>)</li> </ul>
5.	To start cooking, touch ▷ ◻.

### Choosing the baking system

Symbol	Use
	<b>HOT AIR</b> Hot air allows for better air circulation around the dish. In this way, it dries its surface more and creates a thicker crust. For roasting meat, baking cakes and vegetables and for drying food at one or more levels at the same time.
	<b>TOP AND BOTTOM HEATER</b> Use this system for conventional baking on a single rack, making soufflés, and baking at low temperatures (slow cooking).
	<b>PIZZA SYSTEM</b> This system is optimal for baking homemade pizza and pastry with higher water content. Use it to bake on a single rack, when you want the food to be done faster and to be crunchy.



Table continued from last page

Symbol	Use
 ☑ STEAM ☑	<p><b>INTENSIVE BAKING</b> <sup>1)</sup></p> <p>This cooking method gives the food a crispy crust, without added fat. It is a healthy version of "fast food" with a lower calorie content. Suitable for small cuts of meat, fish, vegetables and pre-cooked frozen products (fries, chicken medallions). The addition of steam cooks the surface better and creates a crunchy crust.</p>
	<p><b>GRILL WITH HOT AIR</b></p> <p>Hot air allows better flow of hot air around the food. This will dry out the surface. In combination with the grill heater/broiler, this will also result in a more intensive colour. For faster baking of meat and vegetables.</p>
	<p><b>TURBO BAKE</b></p> <p>For dishes where even crispiness from all sides is desirable. The system is also suitable as the first step in the step baking mode, as it allows quick browning of the surface in the first stage and slow baking in the second stage. The meat will be juicy with a nicely browned crust.</p>
	<p><b>LARGE GRILL</b></p> <p>For baking large quantities of flat foods (toasted bread, canapees, sausages for grilling, steaks, fish, skewers, etc.), for cooking au gratin and for achieving a nice crispy crust. The heaters mounted on the top of the oven cavity heat the entire surface evenly. Maximum permitted temperature is 240 °C.</p>
	<p><b>GENTLE BAKING</b></p> <p>For gentle and controlled slow cooking of delicate food (soft cuts of meat) and baking pastry with a crunchy bottom.</p>
 ☑ STEAM ☑	<p><b>TOP AND BOTTOM HEATER WITH FAN</b> <sup>1)</sup></p> <p>For the even cooking of dishes on one level and preparation of souffles. The addition of steam roasts the food surface more and creates greater crispness.</p>
 ☑ STEAM ☑	<p><b>LARGE GRILL WITH FAN</b> <sup>1)</sup></p> <p>For roasting poultry and grilling large pieces of meat. The addition of steam roasts the food surface more and creates greater crispness.</p>
	<p><b>LARGE GRILL AND BOTTOM HEATER</b></p> <p>For faster baking on a single rack and for crisply browning the top of your pastry.</p>
	<p><b>GRILL WITH BOTTOM HEATER AND FAN</b></p> <p>For optimum baking of yeast-leavened dough, all types of bread, and for preservation.</p>
 <b>ECO</b>	<p><b>ECO (SLOW COOKING)</b> <sup>2)</sup></p> <p>For gentle, slow and even cooking of meat, fish and pastries on one level. This way of cooking retains a higher proportion of water in the meat, which leaves it juicier and softer, while the pastry becomes evenly browned/baked. It is used for temperatures ranging between 140 °C and 220 °C.</p>
<p>NOTE: For all systems, it is possible to use the gratin function (see chapter 6.1 <i>Additional browning – au gratin</i>).</p>	

<sup>1)</sup> The systems also allow for steam injection during baking (see chapter 5.4 *Steam injection during the baking process*).

<sup>2)</sup> This function is used to determine the energy efficiency class according to EN 60350-1.

## 5.2 Time functions

Symbol	Description	Use
	<b>Baking time</b>	In this mode, you can specify the duration of operation for the oven.
	<b>Egg timer</b>	The independent alarm operates independently of the oven operation. After the set time has expired, the appliance does not turn on or off automatically.
	<b>Delayed end</b>	Use this mode when you want the food in the oven to start cooking with a time delay. Enter the duration and desired end time of cooking. The appliance starts automatically and ends its operation at the desired time.

### Setting duration



1. With the key < or > set the desired cooking time. The display will show ☰ .
2. To start cooking, touch ▷|◻ .

### Setting Egg timer



1. When you touch ☰ , the display will show ⌚ . With the key < or > set the duration of the minute minder. Confirm the setting by touching ☰ .

The maximum possible setting is 24 hours.



NOTE: If the appliance is switched off, the alarm will still be active.

### Setting delayed end



1. First set the baking time. With the key < or > set the desired cooking time. The display will show ☰ .  
*Example: cooking time 2 hours*

Table continued from last page

2.	By double-tapping  the display will show  .
3.	With the key < or > set the time at which you want the dish to be ready. The desired end time is shown on the display. <i>Example: cooking ends at 18:00</i>
4.	To start cooking, touch  . The oven goes into partial standby while waiting to be switched on (the display goes dark). The selected settings are automatically switched on and off at the selected time. <i>Example: cooking starts at 16:00, cooking ends at 18:00</i>
Cooking end time and the clock will alternate on the display unit. After the set time has expired, the oven stops working automatically. The display will show End. A short beep will be emitted.	



**INFORMATION!**

The selected time function can be reset to 00:00 by simultaneously touching < and > .



**WARNING!**





**This function is not suitable for food that requires quick preheating.**

**Perishable food should not be kept in the oven for a long time. Before using this mode, check whether the clock on the appliance is accurately set.**

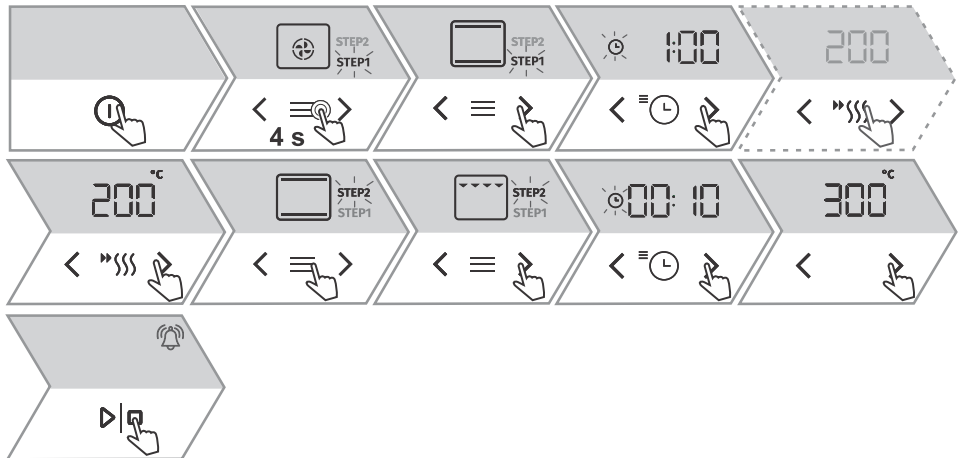
### 5.3 Step bake

This function allows cooking in two steps or stages (two consecutive cooking steps are combined in a single cooking process).





1.	<b>1. STEP 1</b> Turn on the oven. The display shows the default oven setting.
2.	After a long tap (4 seconds) on  , the display will show <b>STEP1</b> (the first step of preparing a dish). Set the baking system, cooking time and temperature. You can also choose fast preheating.
3.	<b>2. STEP 2</b> By touching again on  , the display will show <b>STEP2</b> (the second step of preparing a dish; the first step has already been set).
4.	Set the baking system, cooking time and temperature. You can also change both steps before starting cooking. By touching  , you can go between the two steps.
5.	To start cooking, touch  . The oven first starts working with the settings for the first step.
6.	Cooking by steps can be cancelled by pressing the  key for four seconds.

## 5.4 Steam injection during the baking process

The addition of steam roasts the food surface more and creates greater crispness. The water from the tank drips in a controlled way into the container, which is placed next to the upper heating elements. Just the right amount of steam created in this way bakes the surface of the food better and improves its crispness, while the inside of the food remains soft and fluffy. It is recommended to use the steam addition system when baking goods such as bread, fresh rolls, sponge rolls and cakes, and when cooking small pieces of poultry and vegetables.



### INFORMATION!

Steam injection during the baking process is available with conventional baking system with a fan, large grill with fan, and air fry. In addition to the selected baking system, the symbol  STEAM  will also appear on the display unit.

Symbol for the addition of steam  STEAM  appears on the display (lightly lit) if a temperature above 150 °C has been selected.





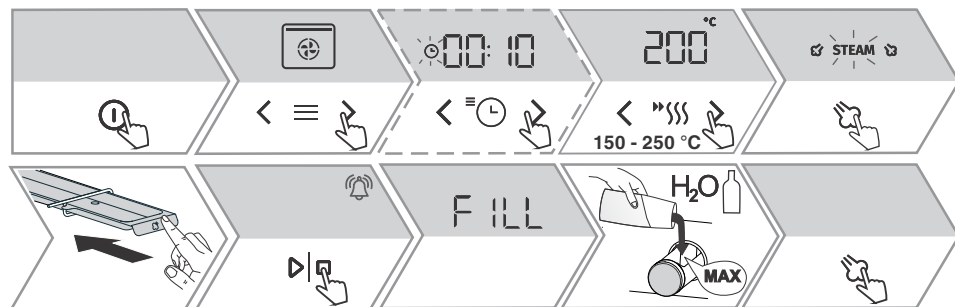



Preheating in systems with steam injection cannot be set. The corresponding steam effect is achieved if the function is switched on while the oven is still cold.

During oven heating, the evaporating tray may deform, but this does not affect its function.



1.	Insert the evaporating dish on the right side, under the top of the oven cavity.
----	--

Table continued from last page

2.	Touch  . Symbol  STEAM  on the display lights up.
3.	To start cooking, touch  . The display will show <b>FILL</b> .
4.	Fill the water tank (see chapter Filling the water tank below) and once again touch  .
5.	The function (addition of steam during cooking) can also be switched off during cooking. Touch  . Symbol  STEAM  remains partially illuminated on the display.

## Filling the water tank

The water tank allows for independent feeding of water into the oven. The volume of the tank is approximately 1.3 dl.

Always fill the tank with clean water from the water supply network or bottled water without additional admixture. The water poured into the tank must have a room temperature of approximately 20 °C (+/- 10 °C).

### **INFORMATION!**

The water tank cannot be removed from the appliance.

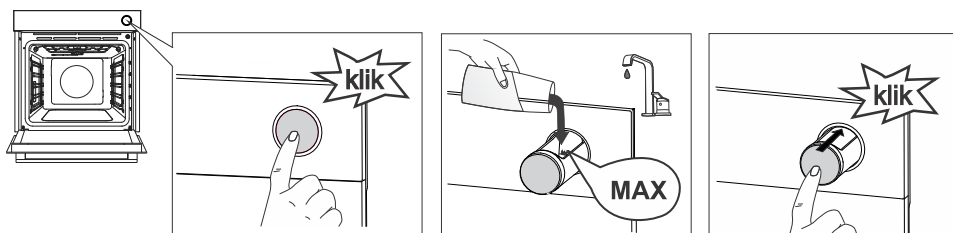

1..	Remove the water tank from the housing by pressing the knob. When you press the knob, the tank jumps out.
2..	Pour the water up to the <b>MAX</b> mark on the water tank.
3..	Press the water tank back into the housing as far as it will go (it will click into place).

### **WARNING!**



If you do not observe the **MAX** indicator and pour too much water into the tank, excess water might spill onto the ground through the gap between the tank cover and the tank.

Do not use distilled water, tap water with high chlorine content, or other similar liquids. Use only fresh tap water, softened water or non-carbonated mineral water.

## Emptying the water tank

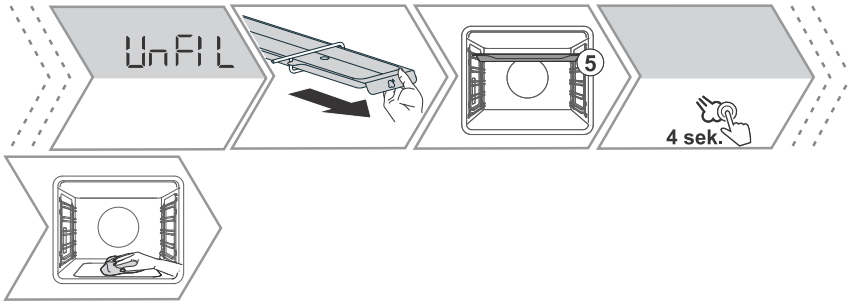
After the oven has cooled down, if you used the steam function during cooking , the display will show **UnFiL** for emptying the water tank.



1.	Remove the food from the oven.
2.	<p>- To drain the water from the tank immediately, remove the evaporating dish and insert a baking tray on the 5th level. Press and hold the key . The process of emptying the water from the tank begins. When the process is complete, remove the baking tray with water from the oven and wipe the oven dry.</p> <p>- To empty the water from the tank later, touch . This means that you want to empty the water tank later.</p>
3.	After use, clean the evaporating dish and the steam system (see chapters 11.3 <i>Cleaning the steam system</i> ).
<p>NOTE: If, after <b>UnFiL</b> appears on the display, you do not perform the procedure, it will show up again on the display the next time you turn on the oven. The water tank can be emptied at any time by long-pressing .</p>	

## 5.5 Automatic cooking mode

In this mode, you can choose between special operating systems.

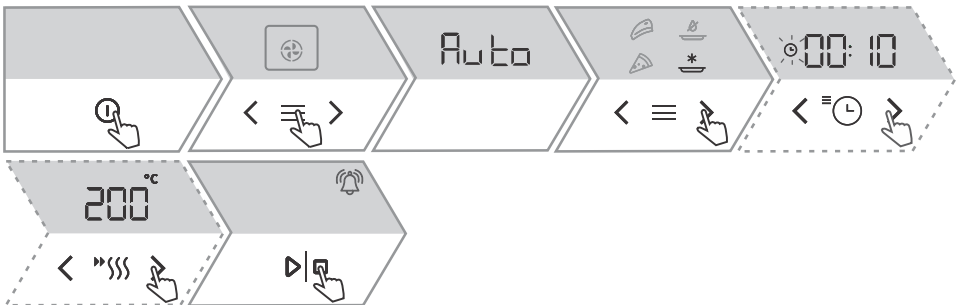









1.	Turn on the oven. The display shows the default oven setting.
2.	Touch  . For a few seconds, the display will show <b>Auto</b> , and then automatic systems will be displayed. By touching  or  , first select the system (see table below). Preset values are displayed. You can change the temperature and duration of cooking.

Table continued from last page



3.	To start cooking, touch   .
4.	Some dishes also include the quick preheating function. The sign will be fully illuminated. When the set temperature is reached, an acoustic signal will sound. The display will show <b>door</b> . Open the door and insert the dish. The programme automatically resumes baking with the selected settings.

Symbol	Use
	<b>BAKING FROZEN FOOD</b> This method allows baking frozen food in a shorter period of time without pre-heating. Optimum for pre-baked frozen products (bakery products, croissants, lasagne, French fries, chicken nuggets), meat and vegetables.
	<b>PIZZA SYSTEM</b> This system is optimal for baking homemade pizza and pastry with higher water content. Use it to bake on a single rack, when you want the food to be done faster and to be crunchy.
	<b>MEAT SYSTEM</b> For optimal meat preparation. Before baking sear the meat on all sides in a pan of hot oil. This method of preparation will preserve its juiciness. It is suitable for meat cuts such as roast beef, fillet of beef, back cuts, etc.
	<b>AIR FRY</b> This cooking method gives the food a crispy crust, without added fat. It is a healthy version of "fast food" with a lower calorie content. Suitable for small cuts of meat, fish, vegetables and pre-cooked frozen products (fries, chicken medallions).

## 5.6 Automatic programs

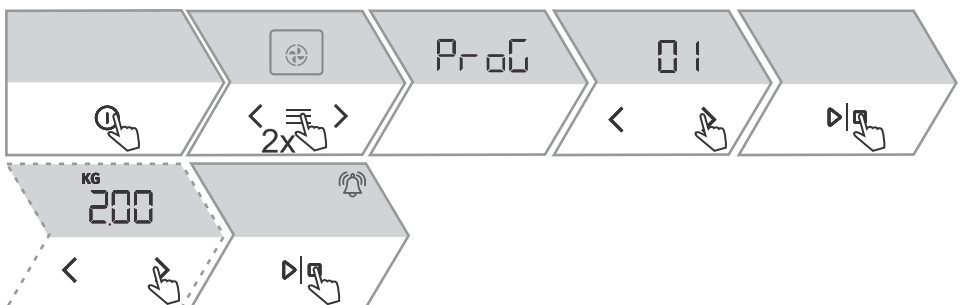
In the automatic mode, you may choose between numerous automatic programmes (the appliance will recommend the optimum cooking method, temperature, and cooking duration depending on the type of food specified).



1.	Turn on the oven. The display shows the default oven setting.
2.	By double tapping  , the display will briefly show <b>ProG</b> , and then automatic programmes will be displayed. By touching < or > select the programme (see table below). Confirm your selection with  . Depending on the desired dish, the appliance will recommend the optimal heating mode, temperature and duration of cooking. Where possible, you can adjust the weight of the dish.
3.	To start cooking, touch  .

Designation	Program name	Equipment	Level.	Preheating	Turning
Pr01	<b>piped cookies</b>	shallow baking tray	3	yes	no
Pr02	<b>cupcakes</b>	shallow baking tray	3	yes	no
Pr03	<b>sponge cake</b>	baking pan/dish on wire rack	2	yes	no
Pr04	<b>yeast-leavened small pastry</b>	shallow baking tray	2	yes	no
Pr05	<b>puff pastry</b>	shallow baking tray	2	yes	no
Pr06	<b>apple pie</b>	baking pan/dish on wire rack	2	no	no
Pr07	<b>apple strudel</b>	shallow baking tray	2	no	no
Pr08	<b>chocolate soufflé</b>	baking pan/dish on wire rack	3	yes	no
Pr09	<b>rising and proofing</b>	shallow baking tray	2	no	no
Pr10	<b>bread</b>	shallow baking tray	2	no	no
Pr11	<b>pork roast</b>	small baking dish on wire rack	2	no	no
Pr12	<b>roasted beef</b>	small baking dish on wire rack	2	no	no
Pr13	<b>poultry – whole</b>	wire rack with a drip tray	2	no	after 2/3 of cooking time
Pr14	<b>poultry – smaller pieces</b>	wire rack with a drip tray	3	no	after 2/3 of cooking time
Pr15	<b>meat loaf</b>	baking pan/dish on wire rack	2	no	no
Pr16	<b>oven-baked beef steak</b>	wire rack with a drip tray	4	no	after 2/3 of cooking time
Pr17	<b>meat – slow cooking</b>	small baking dish on wire rack	2	no	no
Pr18	<b>baked/grilled fish</b>	wire rack with a drip tray	4	no	after 2/3 of cooking time
Pr19	<b>baked potatoes – wedges</b>	all-purpose deep baking tray	3	no	no

Table continued from last page

Designation	Program name	Equipment	Level.	Preheating	Turning
Pr20	Vegetable soufflé	baking pan/dish on wire rack	2	no	no
Pr21	lasagne	baking pan/dish on wire rack	2	no	no
Pr22	homemade pizza	shallow baking tray	1	yes	no

## 5.7 Additional functions

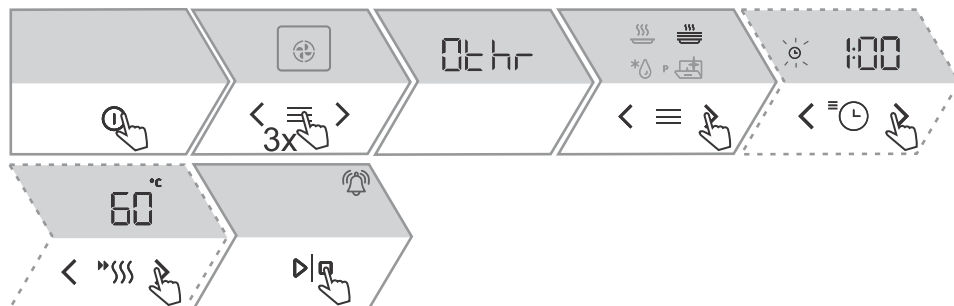

1. Turn on the oven. The display shows the default oven setting.
2. By repeatedly touching , the display will briefly show **Othr**, and then additional functions will be displayed. With the key or select a function (see table below). Preset values are displayed. Some functions allow you to set the temperature and cooking time.
3. To start cooking, touch .

Symbol	Use
	<b>Pyrolysis</b> This function allows automatic cleaning of the oven interior by high temperature that incinerates the fat residues and other impurities to reduce them to ashes.
	<b>Defrosting</b> Use this function to slowly defrost frozen food (cakes, pastry, bread, rolls, and deep-frozen fruit). Halfway through the defrost time, the pieces should be turned over, stirred and separated if they were frozen together.
	<b>Reheating</b> It is used to maintain the heat of already prepared dishes. You can set the temperature.
	<b>Plates heating</b> It is used if you want to preheat the plates or cups so that the food stays warm for a long time. You can set the temperature.

## 6. Starting the cooking process

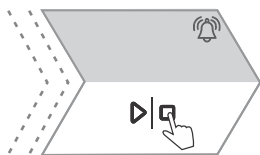

Start cooking by touching  $\triangleright|$  .

Until the set temperature is reached, the current and set temperature are displayed alternately. The temperature symbol flashes first, but when the desired temperature is reached, it goes out and an acoustic signal sounds.

During the cooking process, you can change the system, temperature, and timer functions.

### 6.1 Additional browning – au gratin

This function is used in the last phase of cooking, when we add dressing/topping to the dish or we want to crispen its surface. When using the gratin function, a crispy golden yellow crust is formed on the dish, which protects it from drying, and at the same time gives the dish a nicer appearance and better taste.



#### WARNING!

**Control the cooking. When using the gratin function, the oven reaches high temperatures. The gratin function will be active for 15 minutes at most, then the oven switches off.**

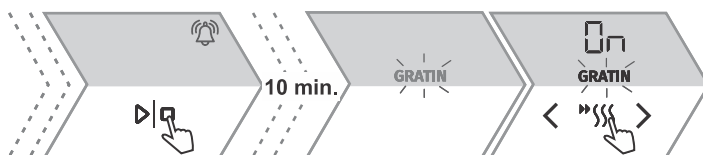

1.	While cooking, touch $\text{»'''}$ . Symbol <b>GRATIN</b> lights up on the display, which also shows On.
2.	<b>The function can also be switched off during operation.</b> - Touch $\text{»'''}$ , the symbol <b>GRATIN</b> on the display will go out and the cooking will continue according to the selected settings. - Turn off the cooking by touching $\triangleright $ .

## 7. End of cooking by touching

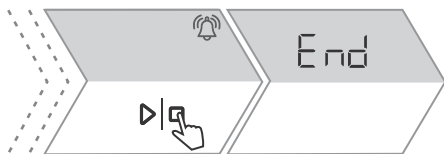

End cooking by touching  $\triangleright|$  . The display shows **End** and the achieved cooking time. A short beep will be emitted.

**INFORMATION!**

After the operation is completed, all timer settings are also stopped and deleted, except for the egg timer. Time of day (clock) will be displayed. The cooling fan will continue to operate for a while.

After the use of the oven, some water may be left in the condensate channel (underneath the door). Wipe the channel with a sponge or a cloth.

# 8. General settings



**WARNING!**

After a power outage or after the appliance is switched off, additional function settings will remain stored for no more than a few minutes. Then, all settings, except for the acoustic signal volume and display dimmer will be reset to factory defaults.

Example of time setting:

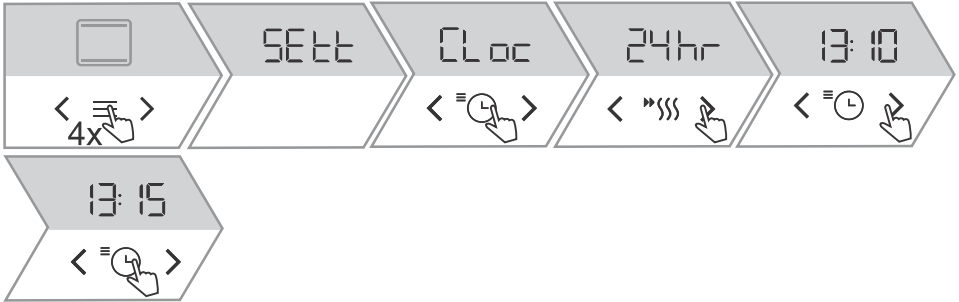







Example of adjusting the signal volume:



1.		<p>By repeatedly touching  , the display will briefly show <b>SEtt</b>, and then the general settings menu will be displayed. You can navigate between different settings by pressing the button. &lt; or &gt; .</p>
2.		<p>The display shows <b>CLock</b>. To set the clock, first touch  . Select a 12h or 24h display and then set the time. Confirm the selection again by touching  .</p>
<p>NOTE: You can edit the individual setting by pressing &lt; or &gt; .</p>		
3.		<p><b>Acoustic signal volume</b> The display will show <b>Vol</b>. You can choose between four volume levels (zero bars – off (OFF), one, two or three bars).</p>
4.		<p><b>Display brightness</b> Select the setting <b>brht</b>. You can choose between three levels of display brightness (one, two or three bars).</p>

Table continued from last page

5.		<p><b>Display - night mode</b> It is a feature that automatically reduces display brightness during night time (between 20:00 and 6:00) and turns off the clock display as well as the acoustic signals. Select the setting <b>nGht</b>. Select power on (On) or off (OFF).</p>
6.		<p><b>Hide clock</b> It is a function that turns the clock display on or off. Select the setting <b>hidE</b>. Select power on (On) or off (OFF).</p>
7.		<p><b>Automatic quick preheating</b> The function allows quick preheating to be automatically added to cooking systems that allow for it. Select the setting <b>Prht</b>. Select power on (On) or off (OFF).</p>
8.		<p><b>Sabbath</b> The Sabbath function allows the food in the oven to stay warm without having to turn the oven on and off. Select the setting <b>SAbb</b>. Set operation duration (between 24 and 72 hours) and temperature. When you touch <math>\triangleright \square</math>, the countdown begins. The display will show <b>SAbb</b>. All sounds and operations are switched off except for the key <math>\textcircled{1}</math>. NOTE: In case of a power outage, Sabbath mode will be deactivated and the oven will return to its initial state.</p>
9.		<p><b>Factory default settings</b> This function allows the appliance to be reset to factory settings. The display will show <b>FAct</b>. Press <math>\triangleright \square</math> for long enough for the line under the inscription to light up completely.</p>
10.		<p><b>Water hardness</b> You can choose between five water hardness levels. The default setting is level 5. <b>Whr 1</b> means water with the lowest hardness. <b>Whr 5</b> means water with the highest hardness.</p>
11.		<p><b>Descaling</b> You can activate the descaling function yourself or it will be suggested by the oven after a certain number of cycles of using the steam function (the display shows <b>dEcL</b>) (see chapter 11.3 <i>Cleaning the steam system</i>).</p>
<p>To exit the general settings menu, touch <math>\equiv</math>.</p>		

## 8.1 Locking keys



- |    |  |
|----|--|
| 1. | With a long tap (6 seconds) on ▷ ◻, the display will show <b>Loc</b> for locking keys. By pressing again on ▷ ◻, you disable the lock. |
|----|--|

- If the lock is activated with no timer function engaged (only clock is displayed), then the oven will not operate.
- If the lock is activated after a timer function has been set, then the oven will operate normally; however, it will not be possible to change the settings.
- When the keys are locked, you cannot change the cooking systems or additional functions. You can only turn off the cooking.
- The keys remain locked even after the oven is switched off. To select a new system, you must deactivate the lock.

## 9. ConnectLife and connectivity (Wi-Fi)

The oven is fitted with a Wi-Fi  wireless connection module that allows connection between the appliance and a mobile device, e.g., a smart phone or a tablet. Connectivity allows remote monitoring of the appliance, as well as remote control of some oven functions. The **ConnectLife** app has to be installed on your mobile device, and a user account has to be registered (see chapter 9.1 *Connecting the appliance to a mobile device*).



### INFORMATION!

Multiple users may be connected to the appliance simultaneously.

Prepare the SSID and password for your home network router. The appliance only supports 2.4 GHz frequency band.

Prepare the label with the QR code of the appliance unique ID (AUID) as you will need it in the appliance connection process when requested by the application.



### WARNING!

**The remote monitoring function via a mobile device should not be used to replace direct personal supervision of the cooking process in the oven. Always regularly check, in person, what is actually going on in the oven.**

## 9.1 Connecting the appliance to a mobile device



The **ConnectLife** app is available in the Apple App Store and Google Play Store.

 ConnectLife



For additional help and information, please visit [www.connectlife.io](http://www.connectlife.io). For other information, functionality and support, please visit [www.connectlife.io/getstarted](http://www.connectlife.io/getstarted).

## 9.2 Wi-Fi module settings





### INFORMATION!

If this setting is not available, then your oven is not fitted with a Wi-Fi module and does not support internet connectivity.





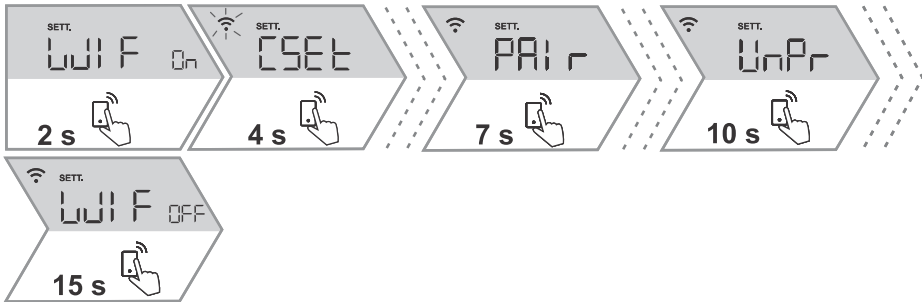

When the Wi-Fi module is enabled and connections are successfully set up and synchronized, then the oven can be controlled and operated via a mobile device and the **ConnectLife** app.

### Turning the Wi-Fi module on and off

To enter the Wi-Fi module function settings, press  for the specified amount of time.

If you touch the  key erroneously, then the settings can be cancelled by long pressing (18 seconds) .



1.	<p><b>Turning on the Wi-Fi module:</b></p> <p>Long press (3 seconds)  . <b>WIF On</b> will appear on the display unit, indicating that the Wi-Fi module is turned on. The symbol  flashes.</p>
2.	<p><b>Connecting an appliance:</b></p> <p>Long press (6 seconds)  . <b>CSEt On</b> will appear on the display unit. Use this setting when connecting the appliance with the <b>ConnectLife</b> app. NOTE: For further settings, follow the instructions in the <b>ConnectLife</b> app.</p>
3.	<p><b>Connecting additional users:</b></p> <p>Long press (9 seconds)  . <b>PAIr</b> will appear on the display unit. Use this setting to connect additional users with the <b>ConnectLife</b> app. NOTE: For further settings, follow the instructions in the <b>ConnectLife</b> app.</p>
4.	<p><b>Removing all connected users:</b></p> <p>Long press (12 seconds)  . <b>UnPr</b> will appear on the display unit. Use this setting to remove all user connections from the <b>ConnectLife</b> app.</p>
5.	<p><b>Turning off the Wi-Fi module:</b></p> <p>Turn off the Wi-Fi connection by long pressing (15 seconds)  . <b>WIF OFF</b> will appear on the display unit.</p>

## Managing the oven remote control

Touch the  key. The symbol **REMOTE** will light up on the display unit to indicate the option of remote control via the **ConnectLife** app.

**INFORMATION!**

For safety reasons, some functions are not available via remote access.

- If the oven is in standby mode and you open the oven door, the remote control option has to be enabled again.
- If oven door is opened during the baking process, the remote control option on the oven is disabled.
- Any user activity on the control unit will automatically disable the remote control option on the oven.
- Cancellation or completion of the baking program or process is the only option that remains available regardless of whether remote control is enabled or not.

**WARNING!**

**Always make sure the oven is used correctly and in compliance with the instructions, especially when using remote control. Do not run the oven via remote access unless you are certain about what exactly is in the oven.**

Wi-Fi status	Wi-Fi symbol on the display unit
Wi-Fi is disabled.	Wi-Fi symbol is not displayed on the display unit.
Wi-Fi is enabled, connection to the server is being established.	Wi-Fi icon is fully lit and flashes.
Wi-Fi is enabled, it is in the setup process or in the process of establishing connections.	Wi-Fi icon is fully lit and flashes.
Wi-Fi is enabled, there are no connections to the server.	Wi-Fi is constantly dimly lit.
Wi-Fi is enabled and it is successfully connected to the server.	The Wi-Fi symbol is constantly fully lit.
Remote control of the oven is not enabled.	REMOTE symbol is not lit on the display unit.
Remote control of the oven is enabled.	REMOTE sign is fully lit on the display unit.

# 10. General tips and advice for baking

## Equipment:

- Use equipment made of heat-resistant non-reflective materials (supplied baking trays and dishes, enamel-coated cookware, tempered glass cookware). Bright-coloured materials (stainless steel or aluminium) materials reflect heat. As a result, thermal processing of food in them is less effective.
- Always insert the baking sheets and trays to the end of the guides. When baking on the wire rack, place the baking dishes or trays in the middle of the rack.
- Do not place the baking trays directly onto the oven cavity bottom.
- Do not use the all-purpose deep baking tray on the 1st guide level while the appliance is operating.
- Do not cover the oven cavity bottom or the wire rack with aluminium foil.
- Always place the baking dishes onto the wire rack.
- When cooking on several levels at the same time, insert the deep all-purpose baking tray into the lower level.
- If you are using parchment paper, make sure it is resistant to high-temperatures. Always trim it accordingly. Parchment paper prevents the food from sticking to the baking tray and makes it easier to remove the food from the baking tray.
- When baking directly on the wire rack, insert the all-purpose deep tray one level lower to serve as a drip tray.

## Food preparation:

- For optimum food preparation, we recommend observing the guidelines specified in the cooking table. Choose the lower specified temperature and the shortest specified cooking time. When this time expires, check the results and then adjust the settings as necessary.
- When cooking according to recipes from older cookbooks, use the bottom and top heater system (as in conventional ovens) and set the temperature 10 °C lower than specified in the recipe.
- When cooking larger cuts of meat or pastry with higher water content, a lot of steam will be generated inside the oven, which in turn may condense on the oven door. This is a normal phenomenon which will not affect the operation of the appliance. After the cooking process, wipe the door and the door glass dry.

## Efficient use of energy

- Preheat the oven only if indicated in the recipe or in the tables in this instruction manual. If you are using quick preheating, do not put food in the oven until the oven is fully heated, unless otherwise recommended. When heating an empty oven, a lot of energy is consumed, so if possible, we recommend that you prepare several dishes in a row or several dishes at the same time.
- Remove all unnecessary equipment from the oven during baking
- Unless it is absolutely necessary, do not open the oven door during baking.
- With longer cooking programs, you can switch off the oven approximately 10 minutes before the end of cooking time to make use of the accumulated heat.

## 10.1 Cooking table

NOTE: Dishes requiring a fully pre-heated oven are indicated with a single asterisk in the table. \* Dishes that only require a 5-minute preheating of the oven are indicated with two asterisks. \*\*. In this case, do not use the quick preheating mode.

























Dish			 °C	 min
<b>PASTRY AND BAKERY PRODUCTS</b>				
<b>pastry/cakes in moulds</b>				
sponge cake	3	 ECO	200-220	60-70
pie with filling	2		180	60-70
marble cake	2		170-180	50-60
cake with leavened dough, Gugelhupf (Bundt cake, pound cake)	2		170-180	45-55
open pie, tart	3		170-180	35-45
brownies	2		170-180	30-35
<b>pastry on baking trays and dishes</b>				
strudel	2		180-190	60-70
strudel, frozen	2		200-210	34-45
sponge roll	3		170-180*	13-18
buchteln	2		180-190	30-40
<b>biscuits, cookies</b>				
cupcakes	3		160 *	25-35
cupcakes, 2 levels	2, 4		155-165 *	30-40
yeast-leavened small pastry	2		180 *	17-22
yeast-leavened small pastry, 2 levels	2, 4		160 *	18-25
puff pastry	3	 ECO	200-220	30-45
puff pastry, 2 levels	2, 4		170 *	25-30
<b>cookies/biscuits</b>				
piped cookies	3		150 *	30-40
piped cookies, 2 levels	2, 4		150 *	30-40
piped cookies, 3 levels	1, 3, 5		145 *	40-50
cookies/biscuits	3	 ECO	160-180	40-50

Table continued from last page

























Dish			°C	min
biscuits, 2 levels	2, 4		150-160 *	20-25
meringue	3		80-100 *	120-150
meringue, 2 levels	2, 4		80-100 *	120-150
macarons	3		130-140 *	15-20
macarons, 2 levels	2, 4		130-140 *	15-20
<b>bread</b>				
rising and proofing	2		40-45	30-45
bread on a baking tray	2	 STEAM	190-200	40-55
bread on a baking tray, 2 levels	2, 4		190-200 *	40-55
bread in a tin	3		190-200	30-45
bread in a tin, 2 levels	2, 4		200-210	30-45
flatbread (focaccia)	2		270	15-25
fresh bread rolls (Semmel/morning rolls)	3		180-200	20-30
fresh bread rolls (Semmel/morning rolls), 2 levels	2, 4		200-210 *	15-20
toast	5		240	4-6
open sandwiches	5		240	3-5
<b>pizza and other dishes</b>				
homemade pizza	1		300 *	4-10
homemade pizza, 2 rack levels	2, 4		210-220 *	25-30
frozen pizza	2		200-220	10-20
frozen pizza, 2 levels	2, 4		200-220	10-25
savoury pie, quiche	2		190-200	50-60
burek	2		180-190	40-50
<b>MEAT</b>				
<b>beef and veal</b>				
beef roast (loin, rump), 1.5 kg	2		160-170	130-160
braised beef, 1.5 kg	2		200-210	90-120

Table continued from last page



























Dish			 °C	 min
sirloin, medium done, 1 kg	2		170-190 *	40-60
beef roast, slow cooked	2		120-140 *	250-300
beef steaks, well done, thickness 4 cm	4		220-230	25-30
burgers, thickness 3 cm	4		220-230	25-35
veal roast, 1.5 kg	2		160-170	120-150
<b>pork</b>				
pork roast, rump, 1.5 kg	3	 ECO	200-220	100-200
pork roast, shoulder, 1.5 kg	3		180-190	90-120
pork loin, 400 g	2		80-100 *	80-100
pork roast, slow cooked	2		100-120 *	200-230
pork ribs, slow cooked	2		120-140 *	210-240
pork chops, thickness 3 cm	4		220-230	20-25
<b>poultry</b>				
poultry, 1.2–2.0 kg	2	 STEAM	200-220	60-80
poultry with stuffing, 1.5 kg	2		170-180	70-90
poultry, breast	2		170-180	45-60
chicken thighs	3	 STEAM	210-220	25-40
chicken wings	4		210-220	25-40
poultry, breast, slow cooked	3		100-120 *	60-90
<b>meat dishes</b>				
meat loaf, 1 kg	2		170-180	60-70
grill sausages, bratwurst	4		230 **	8-15
<b>FISH AND SEAFOOD</b>				
whole fish, 350 g	4	 STEAM	230-240	12-20
fish fillet, thickness 1 cm	4		220-230	8-12
fish steak, thickness 2cm	4		220-230	10-15

Table continued from last page































Dish			°C	min
scallops	4		230 *	5-10
shrimps	4		230 *	3-10
<b>VEGETABLES</b>				
baked potatoes, wedges	3	 ☑ STEAM ☑	210-220 *	30-40
baked potatoes, halved	3	 ☑ STEAM ☑	200-210 *	40-50
stuffed potato (jacket potato)	3		190-200	30-40
French fries, home-made	4		210-220 *	20-30
mixed vegetables, wedges	3	 ☑ STEAM ☑	190-200	30-40
stuffed vegetables	3		190-200	30-40
<b>CONVENTIONAL PRODUCTS – FROZEN</b>				
French fries	3		210-220	20-25
french fries, 2 levels	2, 4		190-210	30-40
chicken medallions	4		210-220 *	12-17
fish fingers	2		210-220	15-20
lasagne, 400 g	2	 *	200-210	30-40
diced vegetables	2	 *	190-200	20-30
croissants	3	 *	170-180	18-23
<b>BAKED PUDDINGS, SOUFFLÉS AND DISHES AU GRATIN</b>				
potato moussaka	2		180-190	35-45
lasagne	2		180-190	35-45
sweet baked pudding	2		160-180	40-60
sweet soufflé	2		160-180 *	35-45
dishes au gratin	3		170-190	30-45
stuffed tortillas, enchiladas	2		180-200	20-35
grilling cheese	4		240 **	6-9
<b>OTHER</b>				
preservation	2		180	30

Table continued from last page

Dish			°C	min
sterilization	3		125	30
cooking in a bain-marie (double boiler)	2		150-170 *	/
reheating	3		60-95	/
plate warming	2		75	15

## 10.2 Cooking with a Temperature Probe (BAKESENSOR)

The food probe allows for accurate monitoring of the core temperature of the food during cooking.



### WARNING!

The food probe should not be in direct vicinity of the heating elements.

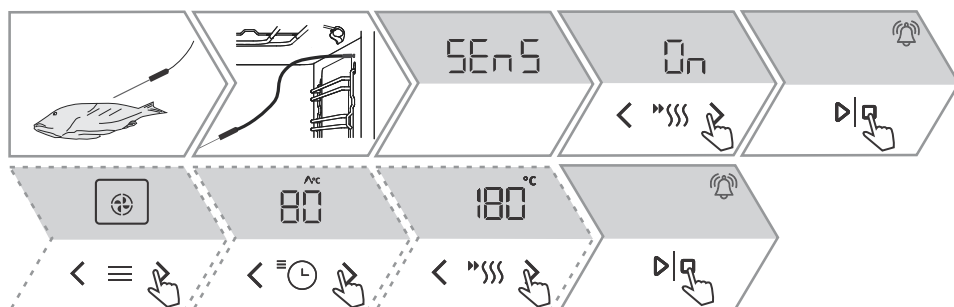

- Stick the metal end of the probe into the thickest part of the food.
- Insert the probe plug into the socket located in the upper right corner at the front of the oven (see figure).  
The display will show **SEnS**. To turn on the function, touch < or > to select On. Do the same to turn off the function. On the display, select OFF. Confirm the setting by touching >|□ .  
NOTE: To enter the menu **SEnS**, the current cooking must be interrupted and the temperature probe must then be plugged into the socket. By inserting the probe into the socket, the pre-set functions on the oven are deleted.
- Select the desired cooking system and temperature (up to 210 °C). The display shows the probe operating symbol and the preset temperature, which can be changed. Determine the desired final core temperature of your food (between 30 and 99 °C).  
NOTE: When using the probe, setting the cooking time is not possible.
- Confirm the setting by touching >|□ .  
During cooking, the set temperature and current temperature of the foodstuff are alternated on the display. If desired, you can change the cooking temperature or the desired core temperature of the foodstuff during operation.
- When the set core temperature is reached, the oven will stop operating. **End** will appear on the display unit. An acoustic signal will be heard which you may turn off by touching any key. After one minute, the acoustic signal will be switched off automatically.

### Correct use of the probe, by type of food:

- poultry: stick the probe in the thickest part of the breast;
- red meat: stick the probe into a lean part that is not marbled with fat;
- smaller chunks with bone: stick them into an area along the bone;
- fish: stick the probe behind the head, towards the spine.



#### INFORMATION!

If you do not use the probe, remove it from the oven.



#### WARNING!

After use, carefully remove the probe from the food, unplug from the socket in the oven cavity, and clean it.

### Recommended doneness levels for different types of meat





















Type of food	 / °C / 	medium rare	medium	medium well	well done
<b>BEEF</b>					
beef, roast	 / 170 / 2	48-52	53-58	59-65	68-73
beef, sirloin	 / 140 / 2	49-53	54-57	58-62	63-66
roast beef/rump steak	 / 160 / 3	49-53	54-57	58-62	63-66
burgers	 / 210 / 4	54-57	60-63	66-68	71-74
<b>VEAL</b>					
veal, sirloin	 / 140 / 2	49-53	54-57	58-62	63-66
veal, rump	 / 160 / 2	49-53	54-57	58-62	63-66
<b>PORK</b>					
roast, neck	 / 170 / 3	/	/	65-70	75-85
pork, loin	 / 140 / 2	/	/	60-69	/
meat loaf	 / 170 / 2	/	/	/	80-85
<b>LAMB</b>					
lamb	 / 170 / 3	60-65	66-71	72-76	77-80
<b>MUTTON</b>					
mutton	 / 170 / 3	60-65	66-71	72-76	77-80
<b>GOAT MEAT</b>					
goat	 / 170 / 3	60-65	66-71	72-76	77-80
<b>POULTRY</b>					
poultry, whole	 / 210 / 2	/	/	/	82-90
poultry, breast	 / 170 / 2	/	/	/	62-65

Table continued from last page

Type of food	 / °C / 	medium rare	medium	medium well	well done
<b>FISH AND SEAFOOD</b>					
trout	 / 210 / 4	/	/	62-65	/
tuna	 / 210 / 4	/	/	55-60	/
salmon	 / 210 / 4	/	/	52-55	/

# 11. Cleaning and maintenance



## WARNING!

Be sure to unplug the appliance from the power supply and wait for the appliance to cool down.

**Children should not clean the appliance or perform maintenance tasks without proper supervision.**

- For easier cleaning, oven cavity and baking tray are coated with special enamel for a smooth and resistant surface.
- Regularly clean the appliance and use warm water and hand dishwashing liquid to remove larger impurities and limescale. Use a clean soft cloth or sponge cloth.
- Never use aggressive or abrasive cleaners and accessories (abrasive sponges and detergents, stain and rust removers, scrapers for glass ceramic plates).
- Food residue (fat, sugar, protein) can ignite during the use of the appliance. Therefore, remove larger chunks of dirt from the oven interior and accessories before each use.
- Oven equipment is dishwasher-safe.

<b>Exterior of the appliance</b>	Use hot soapy water and a soft cloth to remove impurities and wipe the surfaces dry.
<b>Interior of the appliance</b>	For stubborn dirt or grime, use conventional oven cleaners. After using such agents, wipe the appliance thoroughly with a wet cloth to remove any residual cleaning agents.
<b>Utensils and guides</b>	Clean with hot soapy water and a damp cloth. In case of persistent dirt, we recommend prior soaking and the use of a brush.
If the cleaning results are not satisfactory, repeat the cleaning process.	

## 11.1 Automatic oven cleaning – pyrolysis

Thanks to the high temperatures, the function allows for the easy cleaning of the interior of the appliance and some of the supplied equipment (deep universal baking tray, shallow baking tray and guides). During cleaning, fat residues and other impurities are incinerated and cremated.

There are three pyrolysis (cleaning intensity) levels available, with varying duration of the process:

Level	Cleaning intensity	Cleaning purpose	Program duration
— — —	Quick cleaning	For minor impurities	2h
— — — —	Medium-intensity cleaning	For noticeable major impurities	2 h 15 min
— — — — —	Intensive cleaning	For stubborn and persistent (older) impurities	2hrs 30mins
NOTE: The more stubborn the dirt, the higher the level that should be selected.			

### Preparing for pyrolytic cleaning

Based on an average oven usage rate, we recommend pyrolytic cleaning once a month.

- Remove the Airfry grid tray, the evaporating dish and the temperature probe from the oven.

- Remove all visible dirt and food residue from the oven.
- Only start pyrolytic cleaning when the appliance is cooled.
- It is possible to clean the supplied equipment: the deep universal baking tray, shallow baking tray and guides.
- Insert the accessories into the groove on the second or third guide level – never use the first guide level.
- After the pyrolytic cleaning, wait for the equipment to cool down and clean it with hot soapsuds and a damp cloth.
- When cleaning the pull-out guides, pull them out and remove after the procedure has been completed.







### INFORMATION!

For better cleaning results, we recommend cleaning the oven and the accessories/equipment separately. When using the pyrolytic cleaning process to clean the equipment, the oven cavity may not be completely clean at the end of the cycle.

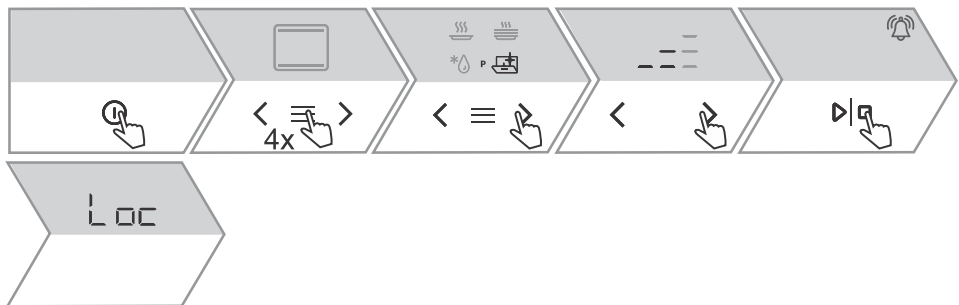
If you are not happy with the cleaning results, we recommend repeating the process.

As a result of automatic pyrolytic cleaning, the interior of the oven and the accessories can change their colour and lose their shine. The pyrolytic pull-out guides can turn yellow, become louder and more rigid, but after repeated use, they should once again run smoothly and without making a noise. This does not affect the functionality of the oven or accessories.



1.	Turn on the oven. By repeatedly touching  , additional features will appear on the display. With the key < or > select the symbol  and designation <b>P</b> so that they both light up. The display shows three cleaning levels.
2.	With the key < or > select the cleaning level.
3.	Touch  . The time starts counting down.
4.	The oven door locks automatically after a certain time for your safety. During locking, the display will show <b>Loc</b> .
5.	When the programme is finished, the display will show <b>End</b> and a short beep will be emitted.
6.	When the pyrolytic cleaning process is complete and the oven has cooled down, the oven door will be unlocked automatically. Once the oven cavity has fully cooled down, wipe it with hot soapsuds and a soft cloth to remove any residue (e.g. ashes).



**WARNING!**

During pyrolysis, unpleasant odours and smoke, as well as irritating vapours and gases, may be emitted. Therefore, make sure that the room is well-ventilated during the procedure and do not stay in that room for prolonged periods of time. Do not allow children or pets to come close to the oven.

During the pyrolysis process, food and fat residues may ignite. Therefore, remove all impurities from the oven interior before starting the process.

Appliance exterior will heat up to a high temperature during the pyrolytic cleaning process. Do not touch the oven door and never hang and combustible objects, such as kitchen cloths or towels, on the door handle.

Do not attempt to open the door while it is locked (during pyrolytic cleaning and while the appliance is cooling down after the process)! The cleaning process may be terminated and there is a risk of burns!

Small animals or pets can be particularly sensitive to any fumes. We recommend removing them from the room during the pyrolytic cleaning process and ventilating the room thoroughly once the cleaning process is complete.

## 11.2 Cleaning the evaporator tray



**WARNING!**

After use, the evaporator tray can be hot, and there can still be some water in it. To avoid scalding, wait for the oven to cool down completely.

Remove the tray and manually clean the evaporating tray with a hand washing up liquid or in the dishwasher. If there are limescale deposits in the tray, soak it in limescale remover (use the limescale remover according to the instructions provided by its manufacturer) or in spirit vinegar. After cleaning and before replacing it, thoroughly rinse the tray.

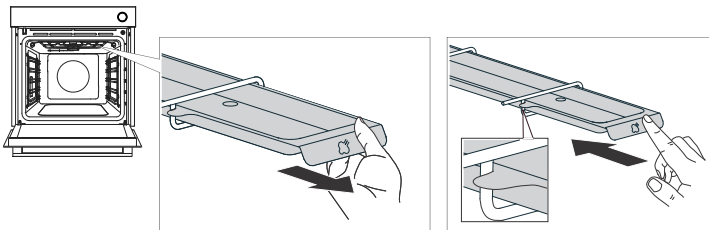

1.	The evaporating dish is fixed on the right side, under the top of the oven cavity hanging from the grill heater.
2.	Grab the evaporating dish and pull it out of the oven.
3.	Clean the evaporator tray with water and detergents.
4.	Before cooking with steam injection again, insert the evaporating dish back into the guides and gently push it all the way in. NOTE: If the tray is not replaced, then water will drip on the food when baking with steam injection.

**INFORMATION!**

Due to its position close to the heaters, the evaporating tray could discolour. This does not affect its function or usability.

## 11.3 Cleaning the steam system

Cleaning depends on how often you use the steam injection function and on the hardness of the water used.

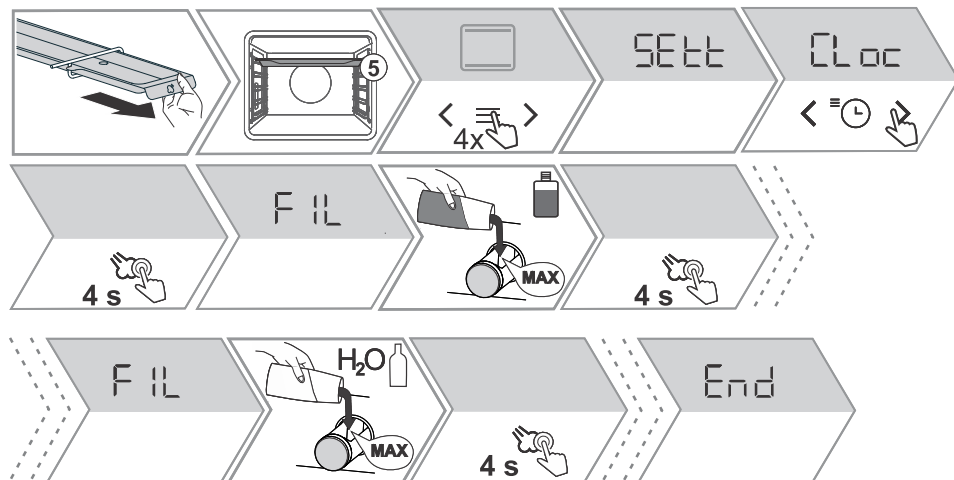

1.	Remove the evaporating dish.
2.	Insert the all-purpose deep baking tray into the 5th (top) guide level to allow the water drip into it.
3.	In the general settings menu, select descaling ( <b>dEeL</b> ). Turn on the function with a long press (4 sec.) on . The descaling process is activated and cannot be cancelled.
4.	The display will show <b>FIL</b> . Fill the tank with descaler and once again press (4 sec.) .
5.	Descaling in progress.
6.	When the process is complete, the display will once again show <b>FIL</b> . Pour fresh rinse water into the tank and press (4 sec.) .
7.	After the rinsing process, <b>End</b> will appear on the display unit.
8.	Remove the baking tray with water from the oven and wipe the oven dry if necessary.

**INFORMATION!**

If you do not want to perform the cleaning of the steam system when the oven prompts you to, you can interrupt this by touching . Cleaning can be cancelled up to three times, after which the oven will disable the steam function.

## 11.4 Removing wire and fixed pull-out (extendible) guides



### INFORMATION!

When removing the guides, take care not to damage the enamel coating.

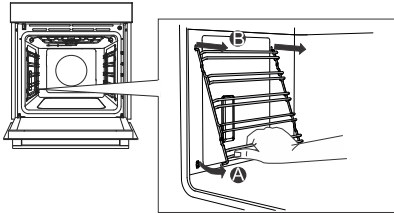

1.	Hold the guides by the bottom side and pull them towards the center of the oven cavity.
2.	Remove them from the openings at the top.

## 11.5 Removing and replacing the oven door and glass panes

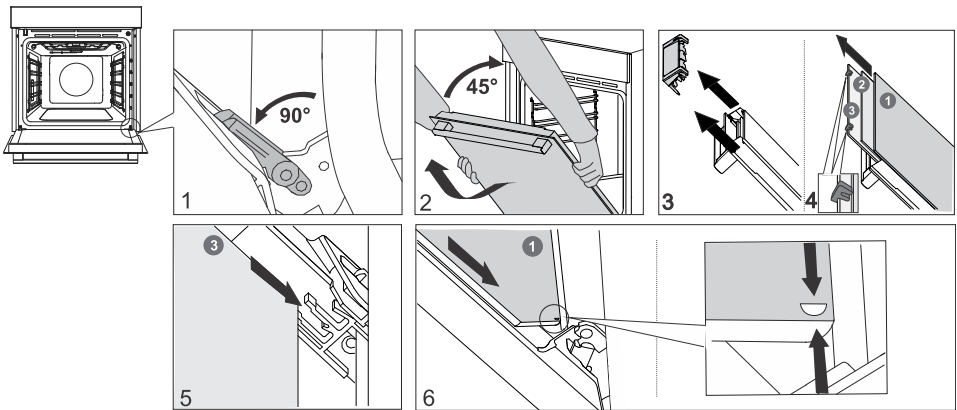

1.	First, fully open the door (as far as it will go).
2.	Oven door is attached to the hinges with special supports that also include safety levers. Rotate the safety levers towards the door by 90°. Slowly close the door to a 45° angle (relative to the position of the fully closed door); then, lift the door and pull it out. <b>The oven door glass</b> can be cleaned from the inside, but it has to be removed from the appliance door first. First do as described in point 2, but do not remove it.
3.	Remove the air guide. Hold it on the left- and right-hand side of the door with your hands. Remove it by slightly pulling it towards you.
4.	Hold the door glass at the upper edge and remove it. To the same for the second and third glass pane (depending on the model).
5.	To replace the glass panes, observe the reverse order.



### INFORMATION!

To replace the door, follow the reverse order. If the door does not open or close properly, make sure the notches on the hinges are aligned with the hinge beds.



### WARNING!

The oven door hinge can close with considerable force. Therefore, always rotate both safety levers to the support when fitting or removing the appliance door.

## Soft door closing and opening

(depending on the model)

Oven door is fitted with a system that dampens the door closing force, starting at the a 75° angle. It allows simple, quiet, and gentle opening and closing of the door. A gentle push (to a 15° angle relative to the closed door position) is enough for the door to close automatically and softly.



### WARNING!

If the force applied to close the door is too strong, the effect of the system is reduced and the safety mechanism effect is decreased.

## 11.6 Replacing the bulb

The light bulb is a consumable and is not covered by warranty. Before changing the bulb, remove any utensils from the oven.

Halogen lamp: G9, 230 V, 25 W



### WARNING!

Only replace the light bulb when the appliance is disconnected from the power supply. Be careful not to damage the enamel. Use protection to avoid burns.



### WARNING!

Appliance functions and equipment depend on the model.

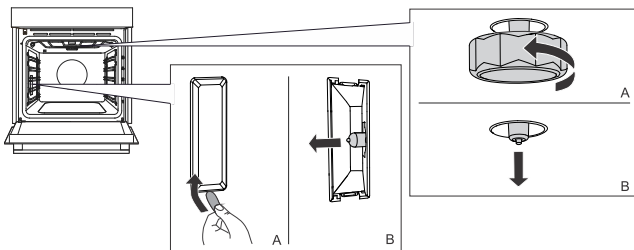

1.	Unscrew and remove the cover (in anti-clockwise direction). Remove the halogen bulb.
2.	Use a flat plastic tool to remove the cover. Remove the halogen bulb.

# 12. Troubleshooting

**During the warranty period, only a service center authorized by the manufacturer may carry out any repairs.**

- Before making any repairs, make sure the appliance is disconnected from the power mains either by removing the fuse or by disconnecting the power plug from the wall outlet.
- Any unauthorized repairs of the appliance may result in electric shock and short circuit hazard; therefore, do not perform them. Leave such work to an expert or a service technician.
- In case of minor problems with appliance operation, check this manual to see if you can fix the problem yourself.
- If the appliance is not operating properly or at all due to inappropriate operation or handling, a visit from a service technician shall not be free of charge, even during the warranty period.
- Save the instructions for future reference and pass them on to any subsequent owners or users of the appliance.
- Following is some advice on rectifying some common problems.

## 12.1 Troubleshooting table

<b>Problem/error</b>	<b>Cause</b>
<b>The main fuse in your home trips often.</b>	Call a service technician.
<b>The oven lighting does not work.</b>	The process of changing the light bulb in the oven is described in the chapter Replacing the bulb.
<b>Control unit is not responding, the screen is frozen.</b>	Disconnect the appliance from the power mains for a few minutes (undo the fuse or switch off the main switch); then, reconnect the appliance and switch it on.
<b>Error code ErrX is displayed. In case of a double-digit error code, the display will show ErXX.</b>	There is an error in the electronic module operation. Disconnect the appliance from the power mains for a few minutes. If the error is still indicated, call a service technician.
<b>The display will show SENs when the temperature probe is not connected.</b>	Clean the socket. Try to connect and disconnect the temperature probe several times in succession.
If the problems persist despite observing the above advice, call an authorized service technician. Repair or any warranty claim resulting from incorrect connection or use of the appliance shall not be covered by the warranty. In this case, the user will cover the cost of repair.	

## 12.2 Label – appliance information

A rating plate with basic information about the appliance is attached to the edge of the oven. Precise information on appliance type and model can also be found on the warranty sheet.

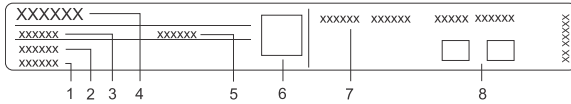

- |                  |                                     |
|------------------|-------------------------------------|
| 1. Serial number | 5. ID/code                          |
| 2. Model         | 6. QR code (depending on the model) |
| 3. Type          | 7. Technical information            |
| 4. Brand         | 8. Compliance labels/symbols        |

## 13. Compliance information

Radio equipment type:	Wi-Fi module
Operating frequency range:	2,412 GHz - 2,472 GHz
Maximum output power:	17,7 dBm EIRP
Maximum antenna gain:	2,7 dBi
<b>Bluetooth indicator</b>	
Frequency range:	2402 ~ 2480 MHz
Carrier Output:	10.00 dBm
Emission type:	F1D

or

Radio equipment type:	Module HLW3215-TG
<b>Wi-Fi</b>	
Operating frequency range:	2.400GHz - 2.4835 GHz
Maximum output power:	≤10 dBm/MHz ( EIRP) (Antenna gain 10 dBi)
Maximum antenna gain:	Gain: 0 dBi
<b>Bluetooth</b>	
Frequency range:	2.400GHz - 2.4835 GHz
Carrier Output:	6 dBm (≤10 dBm)
Emission type:	F1D

The company declares that the device with the function Connectlife complies with the essential requirements and other relevant provisions of Directive 2014/53/EU. The detailed Declaration of Conformity can be found at the web address <https://audid.connectlife.io> on the page of your device among the additional documents.

# 14. Environment protection



Our product packaging is made of environmentally friendly materials that can be recycled, disposed of, or destroyed without any hazard to the environment. To this end, packaging materials are labelled appropriately.

**The symbol** on the product or its packaging indicates that the product should not be treated as normal household waste. Take the product to an authorized collection centre for waste electric and electronic equipment processing.

Correct **disposal** of the product will help prevent any negative effects on the environment and health of people, which could occur in case of incorrect product removal. For detailed information on removal and processing of the product, please contact the relevant municipal body in charge of waste management, your waste disposal service, or the store where you bought the product.

We reserve the right to any changes and errors in the instructions for use.

# 15. Cooking test

EN60350-1: Only use equipment supplied by the manufacturer.

Always insert the baking tray all the way to the end position on the wire guide. Place pastry or cakes baked in moulds as shown in the image.

\* Preheat the appliance to desired temperature. Do not use the rapid preheat mode.

\*\* Preheat the appliance for 10 minutes. Do not use the rapid preheat mode.

\*\*\* Turn after 2/3 of cooking time.























BAKING						
Dish	Equipment	mould placement		 °C	 min	
shortbread – single rack	shallow baking tray		3	150	25-40	
shortbread – single rack	shallow baking tray		3	135 **	35-50	
shortbread – two racks/levels	shallow baking tray		2, 4	140 **	25-40	
shortbread – three racks/levels	shallow baking tray		1, 4, 5	135	45-60	
small cakes – single rack	shallow baking tray		3	160-170 **	20-30	
small cakes – single rack	shallow baking tray		3	155 **	20-30	
small cakes – two racks/levels	shallow baking tray		1,5	140 **	30-45	
small cakes – three racks/levels	shallow baking tray		1, 3, 5	140-150	30-50	
sponge cake	round metal mould, diameter 26 cm/wire rack		2	150	45-55	
sponge cake	round metal mould, diameter 26 cm/wire rack		2	160	45-55	
sponge cake – two racks/levels	2 × round metal mould, diameter 26cm/wire rack		2, 4	170 *	45-55	
apple pie	2 × round metal mould, diameter 20cm/wire rack		2	160 **	70-120	
apple pie	2 × round metal mould, diameter 20cm/wire rack		2	160	70-120	
BROILING						
toast	wire rack		5	max	4-7	

Table continued from last page

<b>BAKING</b>						
beef burgers	wire rack + shallow baking sheet as drip tray		5	230	25-40 ***	

**Hisense**  
life reimagined



901208-a14

