

PRECAUTIONS	38	Using the accessories	49
General safety instructions	38	Using the hob	49
Installation	43	Using the storage compartment (where present)	50
Appliance purpose	44	Using the oven	50
This user manual	44	Using the temperature probe (on some models only)	53
Manufacturer's liability	44	Cooking advice	54
Identification plate	44	Cooking information table	55
Disposal	45	Temperature probe-cooking information table (on some models only)	56
Information for European Control Bodies	45	Cooking information table (auxiliary oven)	57
Energy efficiency technical data	45	CLEANING AND MAINTENANCE	57
To save energy	45	Cleaning the appliance	57
Information on power consumption in off/stand-by mode	45	Knobs	58
Light sources	45	Cleaning the door	58
How to read the user manual	46	Cleaning the oven cavity	60
DESCRIPTION	46	Pyrolytic function (on some models only)	60
General description	46	Extraordinary maintenance	62
Hob	47	INSTALLATION	63
Control panel	47	Gas connection	63
Other parts	48	Positioning	63
Accessories	48	Burner and nozzle characteristics tables	66
USE	49	Electrical connection	69
Preliminary operations	49	Instructions for the installer	70

We advise you to read this manual carefully, which contains all the instructions for maintaining the appliance's aesthetic and functional qualities. For further information on the product: www.smeg.com

PRECAUTIONS

General safety instructions

Risk of personal injury

- **WARNING:** During use the appliance and its accessible parts become very hot. Keep children well away from the appliance.
- Protect your hands by wearing oven gloves when moving food inside the oven.
- Never try to put out a fire or flames with water: Turn off the appliance and smother the flames with a fire blanket or other appropriate cover.
- This appliance may only be used by children aged 8 years and over, and by people of reduced physical, sensory or mental capacity, or lacking in experience in the use of electrical appliances, provided that they are supervised or have been given instructions on the safe use of the appliance and of the hazards associated with it.
- Children must not play with the appliance.

- Keep children under the age of eight at a safe distance unless they are constantly supervised.
- Keep children under the age of 8 away from the appliance when it is in use.
- Cleaning and maintenance must not be carried out by unsupervised children.
- Make sure that the flame-spreader crowns are correctly positioned in their housings with their respective burner caps.
- Be aware of how rapidly the cooking zones heat up. Do not place empty pans on the heat. Danger of overheating.
- The cooking process must always be kept under control. A short cooking process must be continuously monitored.
- Fats and oils can catch fire if they overheat. Do not leave the appliance unattended while preparing foods containing oils or fats. If fats or oils catch fire, never put water on them. Place the lid on the pan and turn off the relevant cooking zone.
- Do not place metal objects, such as dishes or cutlery, on the surface of the hob during cooking as they may overheat.
- **WARNING:** leaving food unattended when cooking using fat or oil can be dangerous and can cause a fire. **DO NOT** attempt to extinguish a fire with water. Turn off the appliance and smother the flames, for example with a lid or a blanket.
- The appliance becomes very hot during use. Take care never to touch the heating elements inside the oven(s).
- Do not insert pointed metal objects (cutlery or utensils) into the slots in the appliance.
- Do not pour water directly onto very hot trays.
- Keep the oven door closed during cooking.
- If you need to move food or at the end of cooking, open the door 5 cm for a few seconds, let the steam come out, then open it fully.
- The surfaces inside the storage compartment (where fitted) may become very hot.
- Do not open the storage compartment (where present) when the oven is on and still hot.
- The items inside the storage compartment (where present) could be very hot after the oven has been used.
- Do not rest any weight or sit on the open door of the appliance.
- Switch off the appliance immediately after use.
- Do not pull the cable to unplug the appliance (if installed).
- **DO NOT USE OR STORE FLAMMABLE MATERIALS IN**

THE STORAGE COMPARTMENT (IF AVAILABLE) OR NEAR THE APPLIANCE.

- DO NOT USE AEROSOLS IN THE VICINITY OF THIS APPLIANCE WHILST IT IS IN USE.
- DO NOT MODIFY THIS APPLIANCE.
- Always wear personal protective equipment (PPE) before carrying out any work on the appliance (installation, maintenance, positioning or moving).
- Do not clean the appliance if it is still hot or in operation.
- Before performing any work on the appliance, switch off the power supply.
- **WARNING:** Make sure that the appliance has been switched off and disconnected from the mains power supply or that the mains power has been switched off before replacing the interior lighting bulbs.
- The bulbs used in this appliance are specific for household appliances; do not use them for home lighting.
- Installation and servicing should be carried out by qualified personnel in accordance with current standards.
- Do not try to repair the appliance yourself or without the assistance of a qualified

technician.

- If the power cable becomes damaged, contact technical support immediately to arrange for it to be replaced in order to avoid possible hazards.
- **WARNING:** A gas cooking appliance produces heat, humidity and combustion products in the room where it is installed. Make sure the kitchen is well ventilated, especially when the appliance is in use: keep the natural ventilation openings open or install a mechanical ventilation device.
- Intensive and prolonged use of the appliance may require additional ventilation, for example opening a window or more effective ventilation; for example by increasing the power of any mechanical suction devices.

Risk of damaging the appliance

- Do not use harsh or abrasive detergents or sharp metal scrapers to clean the glass door of the oven since they may scratch the surface and cause the glass to shatter.
- Use wooden or plastic utensils.
- Do not use steam jets to clean the appliance.
- Do not obstruct ventilation openings and heat dispersal slots.
- Do not sit on the appliance.

- Racks and trays should be inserted as far as they will go into the side guides. The mechanical safety locks that prevent them from being removed must face downwards and towards the back of the oven.

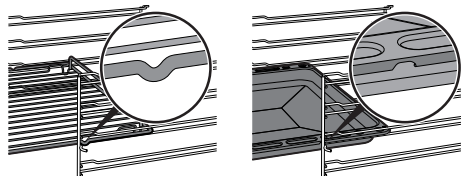

- **CAUTION:** Never leave the appliance unattended when cooking using fats or oils. Risk of fire. Be very careful.
- Risk of fire: Do not store objects on the cooking surfaces.
- Do not spray any spray products near the oven.
- **DO NOT FOR ANY REASON USE THE APPLIANCE AS A SPACE HEATER.**
- Do not use plastic kitchenware or containers for cooking.
- Do not put sealed tins or containers in the oven.
- Remove all trays and racks which are not required during cooking.
- Do not cover the bottom of the oven cavity with aluminium or tin foil sheets.
- Do not place pans or trays directly on the bottom of the oven cavity.
- If necessary, you can use the tray rack (supplied or sold separately, depending on the model) by placing it on the bottom as a support for cooking.
- If you wish to use greaseproof paper, place it so that it will not interfere with the hot air circulation inside the oven.
- Do not use the open door to rest pans or trays on the internal glass pane.
- Cooking vessels or griddle plates should be placed inside the perimeter of the hob.
- All pans must have smooth, flat bottoms.
- If any liquid does boil over or spill, remove the excess from the hob.
- Take care not to spill acid substances such as lemon juice or vinegar on the hob.
- Do not use steam jets to clean the appliance.
- Do not put empty pans or frying pans on switched on cooking zones.
- Do not use rough or abrasive materials or sharp metal scrapers.
- Do not use cleaning products containing chlorine, ammonia or bleach on parts made of steel or that have metallic surface finishes (e.g. anodizing, nickel- or chromium-plating).
- Do not wash removable parts such as the hob pan support grids, flame-spreader crowns

and burner caps in the dishwasher.

- Never use the oven door to lever the appliance into place when fitting.
- Avoid exerting too much pressure on the door when open.
- Take care that no objects are stuck in the doors.
- Do not use the handle to lift or move this appliance.
- Do not spray cleaning products directly onto the door, as they may get into areas that are difficult to access and rinse off. Over time, they may react with painted panels or steel.
- To avoid damaging the racks, do not drag the pans; lift and reposition them instead.

Temperature probe (where present)

- Do not touch the rod or the tip of the temperature probe after use.
- Wear oven gloves when handling the temperature probe.
- Take care not to scratch or damage enamelled or chrome-plated surfaces with the tip or the plug of the temperature probe.
- Do not insert the temperature probe into openings and slots on the appliance.
- When the temperature probe is

not in use, make sure that the protective metal cap is properly closed.

- Do not leave the temperature probe unattended.
- Do not allow children to play with the probe.
- Take care not to injure yourself on the sharp parts of the probe.
- Do not pull the cable to remove the temperature probe from the socket or from the food.
- Make sure that the temperature probe or its cable do not get caught in the door.
- Make sure that the temperature probe or its cable do not come into contact with heating elements inside the oven.
- No part of the temperature probe should be allowed to come into contact with the walls of the oven cavity, the heating elements, the racks or the trays when they are still hot.
- The probe should not be kept inside the appliance.
- Remove the temperature probe from the oven before carrying out the pyrolytic cycle (where available).
- Do not use the temperature probe during the pyrolytic cycle (where available).
- Make sure the plug of the probe is fully inserted into the socket.
- Do not use the probe to place food into or to remove it from

the oven cavity.

- Only use the temperature probe provided with this appliance.

For pyrolytic appliances

- During the pyrolytic cycle, the surfaces could reach temperatures that are higher than usual. Keep children at a safe distance.
- Before starting the pyrolytic cycle, remove any food residues or large spills from previous cooking from the inside of the oven.
- Before starting the pyrolytic cycle, remove all accessories from inside the oven, including the side frames.
- Before starting the pyrolytic cycle, switch off the burners or the electric hot plates of the hob.
- During the first pyrolytic cycle, unpleasant odours may occur due to the normal evaporation of oily manufacturing substances. This is an absolutely normal phenomenon which disappears after the first pyrolytic cycle.
- Make sure that the door is completely closed before starting the pyrolytic cycle

Installation

- **THIS APPLIANCE MUST NOT BE INSTALLED IN BOATS OR CARAVANS.**

- This appliance must not be installed on a pedestal.
- Do not use the handle to lift or move the appliance.
- Position the appliance into the cabinet cut-out with the help of a second person.
- To avoid potential overheating, the appliance must not be installed behind a decorative door or a panel.
- Before installation, make sure that the local distribution conditions (type and pressure of the gas) and the regulation of the appliance are compatible.
- This appliance is not connected to a system for extracting combustion products. It should be installed and connected in compliance with current installation regulations. Pay particular attention to the requirements regarding ventilation.
- The settings for this appliance are shown on the gas setting label.
- Have the gas connection performed by authorised personnel.
- Installation using a hose must be carried out so that the length of the hose does not exceed 2 metres when fully extended for steel hoses and 1.5 metres for rubber hoses.
- The gas connection hoses must

not come into contact with moving parts of the built-in module (for example a drawer) and must not be routed through a space that could cause it to be pinched.

- If required, use a pressure regulator that complies with current regulations.
- After carrying out any operation, check that the tightening torque of gas connections is between 10 Nm and 15 Nm.
- At the end of the installation, check for any leaks with a soapy solution, never with a flame.
- Have the electrical connection performed by authorised technicians.
- The appliance must be connected to earth in compliance with electrical system safety standards.
- Use cables that can withstand temperatures of at least 90°C.
- The tightening torque of the screws of the terminal supply wires must be 1.5 - 2 Nm.
- Fit the power line with an all-pole circuit breaker with a contact separation distance sufficient to provide complete disconnection in category III overvoltage conditions, pursuant to installation regulations.
- This appliance can be used up

to a maximum altitude of 2,000 metres above sea level.

Appliance purpose

This appliance is intended for cooking food in the home environment. Every other use is considered inappropriate. It cannot be used:

- in employee kitchens, shops, offices and other working environments.
- in farms/farmhouses.
- by guests in hotels, motels and residential environments.
- In bed and breakfast accommodation.

This user manual

- This user manual is an integral part of the appliance and must therefore be kept in its entirety and within the user's reach for the whole working life of the appliance.
- Read this user manual carefully before using the appliance.
- The explanations in this manual include images, which describe all that regularly appears on the display. However, it should be kept in mind that the appliance may be equipped with an updated version of the system, and as such, all that appears on the display may differ from those in the manual.

Manufacturer's liability

The manufacturer declines all liability for damage to persons or property caused by:

- use of the appliance other than that specified;
- failure to comply with the instructions in the user manual;
- tampering with any part of the appliance;
- use of non-original spare parts.

Identification plate

The identification plate bears the technical data, serial number and brand name of the appliance. Do not remove the identification plate for any reason.

Disposal



This appliance conforms to the WEEE European directive (2012/19/EU) and must be disposed of separately from other waste at the end of its service life.

The appliance does not contain substances in quantities sufficient to be considered hazardous to health and the environment, in accordance with current European directives.



Power voltage Danger of electrocution

- Disconnect the mains power supply.
- Unplug the appliance.

To dispose of the appliance:

- Cut the power cable and remove it.
- Deliver the appliance to the appropriate recycling centre for electrical and electronic equipment waste, or return it to the retailer when purchasing an equivalent product, on a one for one basis.

Our appliances are packaged in non-polluting and recyclable materials.

- Deliver the packing materials to the appropriate recycling centre.



Plastic packaging Danger of suffocation

- Do not leave the packaging or any part of it unattended.
- Do not let children play with the plastic bags.

Information for European Control Bodies

Main oven

Fan forced mode

The ECO function used to establish the energy efficiency class is compliant with the specifications of European standard EN 60350-1.

Secondary oven

Fan forced mode

The static function  used to establish the energy efficiency class is compliant with the specifications of European standard EN 60350-1.

Energy efficiency technical data

Information in accordance with the European energy labelling and ecodesign regulations is contained in a separate document accompanying the product instructions.

These data are present in the "Product information sheet" that can be downloaded from the website at the page dedicated to the product in question.

To save energy

- Only preheat the appliance if the recipe requires you to do so.
- Unless otherwise indicated on the package, defrost frozen foods before placing them in the oven.
- When cooking several types of food it is recommended to cook the foods one after the other to make the best use of the already hot oven.
- Use dark metal moulds: They help to absorb the heat better.
- Remove all trays and racks which are not required during cooking.
- Stop cooking a few minutes before the time normally used. Cooking will continue for the remaining minutes with the heat which has accumulated inside the oven.
- Reduce any opening of the door to a minimum to avoid heat dispersal.
- Keep the inside of the oven clean at all times.

Information on power consumption in off/stand-by mode

Technical data on the appliance's power consumption in off/stand-by mode can be found at www.smeg.com under the page corresponding to the product in question.

Light sources

- This appliance contains user-replaceable light sources.

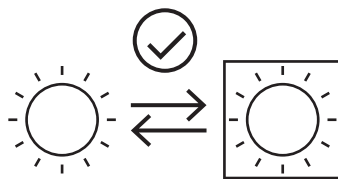

- The light sources contained in the appliance are declared suitable for operation at ambient temperature $\geq 300^{\circ}\text{C}$ and intended

for use in high temperature applications such as ovens.

- This appliance contains light sources of efficiency class "G".

conventions:



Warning/Caution



Information/Advice

How to read the user manual

This user manual uses the following reading

DESCRIPTION

General description

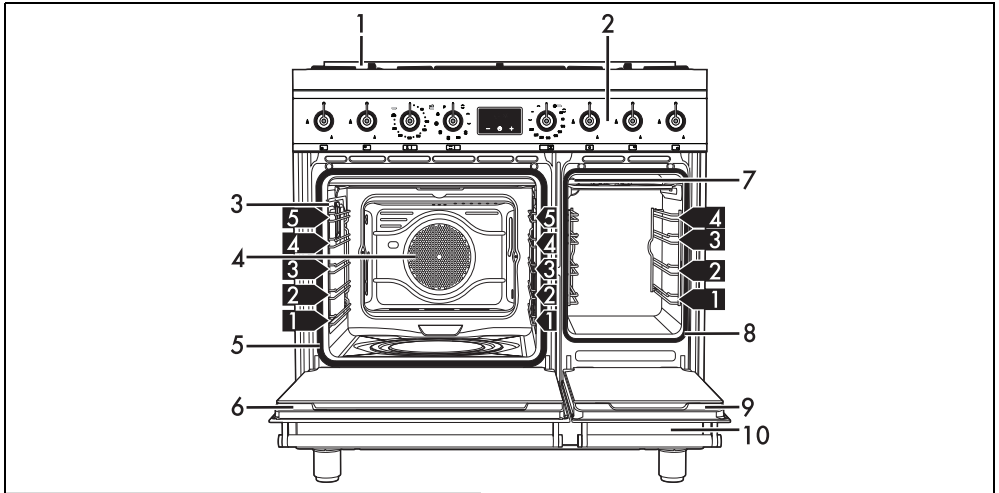
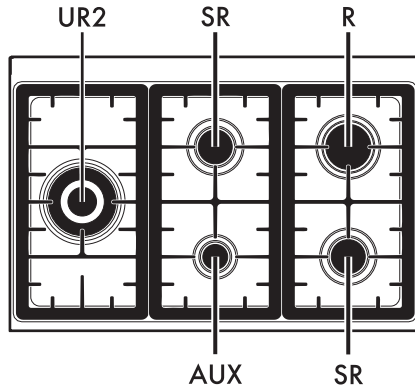

fig. 1

- 1 Hob
 - 2 Control panel
 - 3 Main oven light
 - 4 Fan
 - 5 Main oven seal
 - 6 Main oven door
 - 7 Auxiliary oven light
 - 8 Auxiliary oven seal
 - 9 Auxiliary oven door
 - 10 Storage compartment
- 1,2,3...** Frame shelf



AUX = Auxiliary Burner
SR = Semi-rapid Burner

R = Rapid Burner
UR2 = Ultra Rapid Burner

Control panel

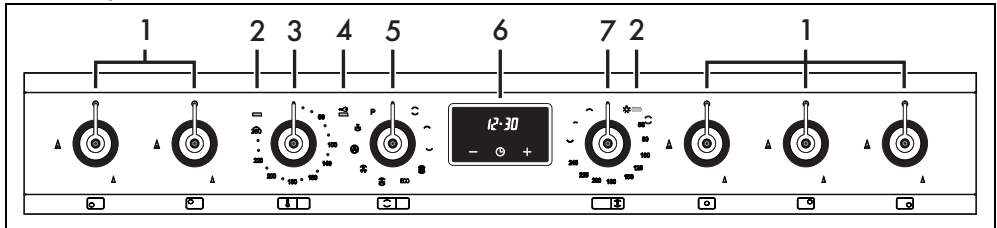

1 Hob cooking zone knobs

Useful for controlling the cooking zones of the induction hob. Press and turn the knobs clockwise to adjust the operating power of the hot plate from a minimum of 1 to a maximum of 9. The working power is indicated on the display on the hob.

2 Main/auxiliary oven indicator light

The indicator light comes on to indicate that the oven is heating up. It turns off as soon as it reaches the set temperature. It flashes regularly to indicate that the temperature set inside the oven is kept constant.

3 Main oven temperature knob

This knob allows you to select the cooking temperature. Turn the knob clockwise to the required value, between the minimum and maximum setting.

4 Pyrolytic cycle indicator light

It comes on when the automatic (pyrolytic) cleaning cycle is activated.

5 Main oven function knob

The oven's various functions are suitable for different cooking modes. After selecting the required function, set the cooking temperature using the temperature knob.

6 Digital programmer

For displaying the current time, setting programmed cooking operations and the minute minder timer.

 The digital programmer only controls the main oven.

7 Auxiliary oven temperature/functions knob

It turns on the light inside the oven or starts the grill and lower heating elements to a temperature ranging from a minimum of 50°C to a maximum of 245°C. At the maximum temperature, it is also possible to select some functions optimised for specific cooking operations.

Other parts

Shelves

The appliance features shelves to position trays and racks at different heights. The insertion heights are indicated from the bottom upwards (see General description).

Cooling fan

The fan cools the oven and comes into operation during cooking. The fan causes a steady outflow of air that exits from the rear of the appliance and which may continue for a brief period of time even after the appliance has been turned off.



Do not obstruct ventilation openings and heat dispersal slots.

Interior lighting

The appliance's interior lighting comes on:

(Main oven)

- When the door is opened.
- When any function is selected, apart from the **ECO** function.



When the door is open, it is not possible to turn off the interior lighting.

(Auxiliary oven)

- when the auxiliary oven temperature/ functions knob is turned to the  symbol or to any other function.

Accessories

- Not all accessories are available on some models.
- The accessories intended to come into contact with food are made of materials that comply with the provisions of current legislation.
- Original supplied and optional accessories can be requested to Authorised Assistance Centres. Use only original accessories supplied by the manufacturer.

Deep tray

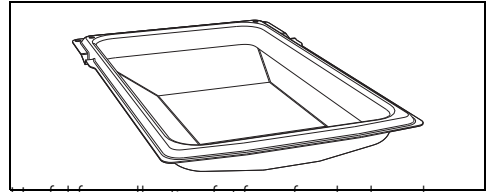
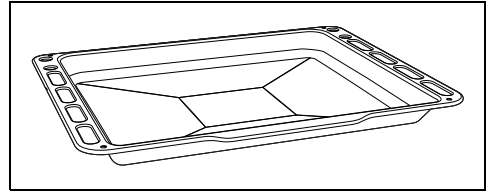

Useful for collecting fat from foods placed on the rack above and for cooking pies, pizzas, baked desserts, biscuits, etc.

Tray rack

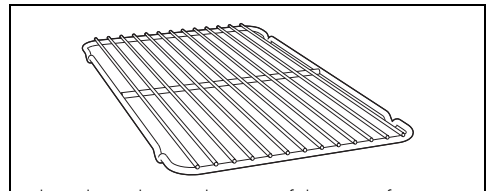
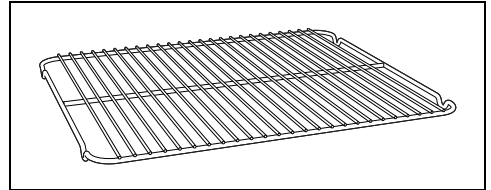

To be placed over the top of the tray; for cooking foods which may drip.

Rack

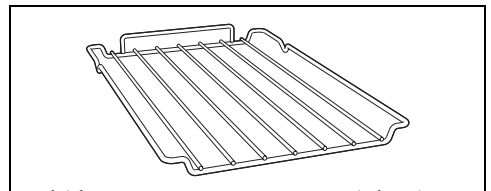
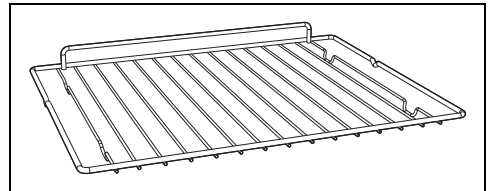

Useful for supporting containers with food during cooking.

Tray

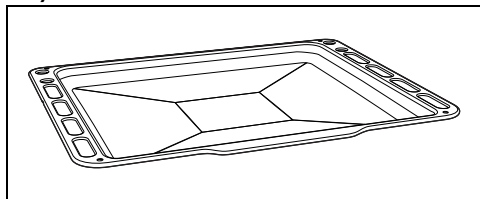

Useful for cooking cakes, pizzas, oven-baked desserts and biscuits.

Temperature probe (on some models only)

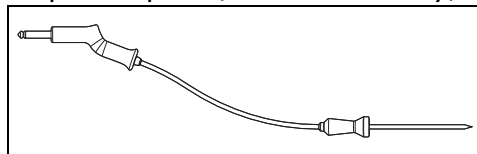

With the temperature probe, you can cook according to the temperature measured at the centre the food.

EN

USE

Preliminary operations



See General safety instructions.

- Remove any protective film from the outside or inside of the appliance, including accessories.
- Remove any labels (apart from the technical data plate) from the accessories and shelves.
- Remove and wash all the appliance accessories (see chapter "CLEANING AND MAINTENANCE").

First heating

1. Set a cooking time of at least one hour (see paragraph "Using the oven").
2. Heat the empty oven compartment at the maximum temperature to burn off any residues left by the manufacturing process.

When heating the appliance

- air the room;
- don't stay.

Using the accessories

Racks and trays

Racks and trays have to be inserted into the side guides until they come to a complete stop.

- The mechanical safety locks that prevent the rack from being removed accidentally must face downwards and towards the back of

the oven cavity.

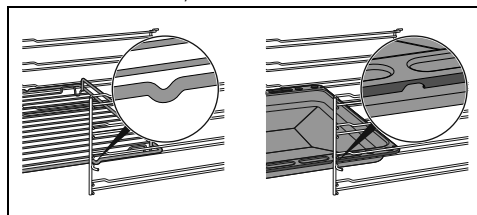

Gently insert racks and trays into the oven until they come to a stop.



Clean the trays before using them for the first time to remove any residues left by the manufacturing process.

Tray rack

The tray rack has to be inserted into the tray. In this way fat can be collected separately from the food which is being cooked.

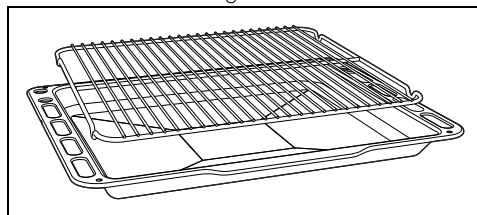

Using the hob

All the appliance's control and monitoring devices are located together on the front panel. The burner controlled by each knob is shown next to the knob. The appliance is equipped with an electronic ignition device. Simply press the knob and turn it anti-clockwise to the maximum flame symbol, until the burner ignites. If the burner does not light in the first 15 seconds, turn the knob to  and wait 60 seconds

before trying again. After lighting, keep the knob pressed in for a few seconds to allow the thermocouple to heat up. The burner may go out when the knob is released: In this case, the thermocouple has not heated up sufficiently.

Wait a few moments and repeat the operation. Keep the knob pressed in longer.



In case of an accidental switching off, a safety device will be tripped, cutting off the gas supply, even if the gas cock is open. Return the knob to  and wait at least 60 seconds before lighting it again.

Using the storage compartment (where present)



See General safety instructions.

The storage compartment is in the bottom of the cooker. To open it, pull it towards you. It can be used to store cookware or metallic objects necessary when using the appliance.

Using the oven



See General safety instructions.

Switching on the main oven

To switch on the oven:

1. Select the cooking function using the function knob.
2. Select the temperature using the temperature knob.



Make sure that the digital programmer shows the cooking duration symbol



otherwise it will not be possible to turn on the oven. Press the  button to reset the programmer clock.

Switching on the auxiliary oven

Turn the temperature/functions knob to the required temperature, between 50°C and 245°C, or to the required function (at the maximum temperature).

List of traditional cooking functions



Not all functions are available on some models.

LIGHT



Turns on the oven light.

STATIC



Traditional cooking, ideal for preparing a single dish. For example cooking roast meats, fatty meats, bread, pies.

BASE



The heat only comes from the bottom of the cavity. Perfect for cakes, pies, tarts and pizzas.

GRILL



Produces excellent grilling and gratinating results. When used at the end of cooking, gives a uniform browning to dishes.

FAN WITH GRILL



Allows optimal grilling, even for thick slices of meat. Perfect for larger cuts of meat.

CIRCULAIRE + BOTTOM



Allows you to quickly finish cooking food that is already cooked on the surface but not internally. Ideal for quiches, suitable for all kinds of dishes.

FAN ASSISTED



Intense and uniform cooking. Ideal for biscuits, cakes and cooking on more than one level.

CIRCULAIRE



The heat is distributed quickly and uniformly. Suitable for all dishes, ideal for cooking on multiple levels without mixing smells or flavours.

TURBO





Allows quick cooking on multiple shelves without mixing the aromas. Perfect for large volumes that call for intense cooking.

ECO

ECO

This function is particularly suitable for cooking on a single shelf with low energy consumption. It is recommended for all types of food except those that may produce a large amount of moisture (e.g. vegetables). To obtain maximum energy savings and reduce cooking times, it is recommended to place food in the oven without preheating.

 When using the ECO function, avoid opening the door during cooking.

 Cooking (and preheating) times are longer with the ECO function and may depend on the amount of food in the oven.

Digital programmer

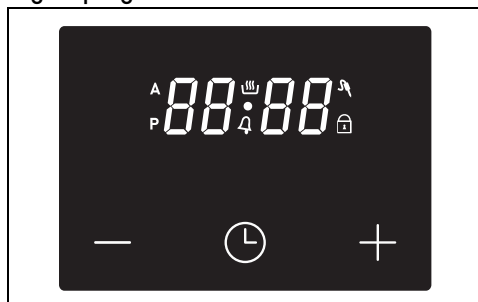

 Decrease key

 Clock key

 Increase key

Display symbols

 Timed cooking

 Pyrolytic cycle

 Cooking

 Minute minder timer

 Temperature probe





 Door lock

Setting the time



 If the time is not set, the oven will not switch on.

On the first use, or after a power failure, the

digits  will be flashing on the appliance's display.

1. Hold the clock button  down for a few seconds. The dot between the hours and the minutes flashes.
2. The time can be set via the increase key  and decrease key . Keep the button pressed to increase or decrease rapidly.
3. Press the clock key  or wait for a few seconds.

The dot between the hours and the minutes stops flashing.

 To change the time, hold down the increase key  and decrease key  at the same time for two seconds, then set the time.

Oven switching-on (manual cooking)

 Depending on the recipe, the food can be placed in the oven cavity either immediately or after preheating.

To switch on the oven:

1. Select the cooking function using the function knob.
2. Select the temperature using the temperature knob.

After a few seconds, the cooking stage starts.

Preheating stage

Cooking itself is preceded by a preheating stage, which allows the appliance to heat to the cooking temperature more quickly.

This stage is indicated by the thermostat

indicator light switching on and the symbol  flashing on the display.

At the end of preheating:

- the thermostat indicator light switches off;
- the symbol  on the display remains steadily lit;
- the appliance beeps;
- cooking starts automatically.

Once preheating is complete, the food can be placed in the oven cavity (if provided for in the recipe).

End of a manual cooking

To end a cooking:

- Turn the function knob and/or the

temperature knob to the 0 position.

Minute minder timer



The minute minder timer does not stop the cooking operation but rather informs the user when the set time has run out.

The minute minder timer can be activated at any time.

1. Press the clock key .

The display shows the text .

2. Use the increase  and decrease  keys to set the required minutes.

3. Press the clock  key or wait for a few seconds to activate the Minute minder timer function.

The current time and the symbol  will appear on the display.



Press the clock  key to see the remaining time on the display.

At the end of the minute minder timer time:

- the symbol  flashes;
- a buzzer sounds, which can be switched off by pressing any key on the display.



The minute minder timer can be set from 1 minute to a maximum of 23 hours and 59 minutes.

Programmed cooking



Programmed cooking is the function which allows a cooking operation to be started at a set time and then ended after a specific length of time set by the user.

1. After selecting the cooking function and temperature using the appropriate knobs, set a timed cooking as described in the previous paragraph.

2. Press the clock key .

The text  will appear on the display in sequence with the pre-set cooking duration added to the current time.

3. Press the  or  key to set the cooking end time.





It is not possible to set a programmed cooking time of more than 24 hours.



Bear in mind that a few minutes for the preheating stage must be added to the cooking time.

4. Press the clock  key or wait for a few seconds to activate the function.



The current time appears and the  and  symbols light up on the display.

The appliance waits to start cooking and finishes at the time set by the user.



To reset the set programming, turn the function knob and/or the temperature knob to the 0 position.

At the end of cooking:

- the heating elements are deactivated;
 - a buzzer sounds, which can be switched off by pressing any key on the display;
 - the flashing text  appears on the display.
5. Press the clock button  to reset the programmer clock.
6. Turn the function knob and/or the temperature knob to position 0 to exit the function.

Modifying the set data



1. Press the clock  key until the type of data to be changed is selected (minute minder timer  - timed cooking

 - programmed cooking).

2. Use the increase  and decrease  keys to change the wished data.

Selecting the buzzer

The buzzer can have 3 tones.

1. Hold down the increase  and decrease  keys at the same time until hearing the buzzer.

2. Press the clock key .

Press the decrease key  to select a different

buzzer tone, among **to n1**, **to n2** and **to n3**.

Using the temperature probe (on some models only)

 See General safety instructions.

The temperature probe enables you to cook roasts, loin steaks and other cuts and sizes of meat with great precision. The probe ensures that the food is perfectly cooked by monitoring the core temperature of the food. The core temperature is measured by a sensor inside the tip of the probe.

Positioning the probe

1. Place the food on a tray.
2. Insert the tip of the probe into the food before placing it in the oven.
3. For best results, make sure that the temperature probe is placed transversely in the thickest part of the food and for least 3/4 of its length. Make sure that it does not touch the tray underneath and that it does not protrude from the food.

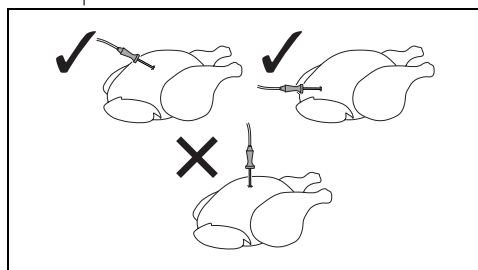

 In order for the probe to measure the core temperature of the food precisely, its tip must not be in contact with bones or fat.

 The minimum recommended oven temperature when cooking using the probe is 120°C, unless slow cooking is used.

Cooking using the temperature probe

Without preheating:

4. Insert the plug of the probe into the socket at the side, using the probe to open the cover.

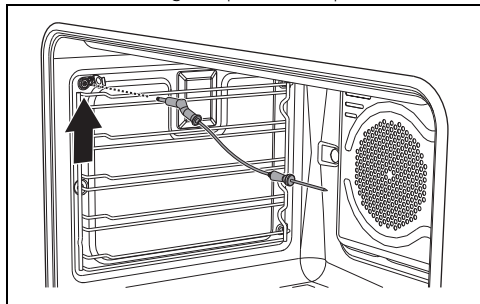

5. Close the door.
6. Set the required cooking function.
7. Set the required temperature.
8. Cooking starts and after a few seconds, the display shows the default target temperature 75°C.
9. Use the **+** and **-** buttons to regulate the target temperature to a value between the minimum and a maximum.



- Minimum target temperature: 45°C.
- Maximum target temperature: 99°C.
- If the temperature read is more than 99°C, "Hi°C" appears on the display.

10. Press the **OK** button to confirm the temperature and start the function, the actual temperature of the food appears on the display.
11. Cooking ends when the set value is reached and "END" appears on the display.

Cooking will now continue until the instantaneous temperature measured by the probe is the same as the target temperature set by the user.

With preheating:

1. Set the oven to manual (see "Using the oven").
2. After preheating, put the tray, on which the food has been placed with the probe in position, into the oven.
3. Insert the plug of the probe into the socket at the side, using the probe to open the cover.
4. Close the door.

- Set up the cooking parameters using the temperature probe as indicated in steps 5, 6, 7 and 8 in the previous section.



If the probe is removed during cooking, "END" appears on the display. If you wish to continue cooking in manual mode, press the  button.



The probe is not detected by the function if it is inserted with the oven switched off.
The probe will not be detected if a cooking function and the relative temperature has not been set.





The probe temperature has to be reset if you change the function during cooking.





When cooking with the temperature probe is in progress



When the temperature probe is used, it is not possible to set programmed cooking or timed cooking.



When cooking with the temperature probe is in progress, the  and  buttons are disabled.

- Pressing and holding the clock button  will activate the minute minder timer; press  again to display the target temperature and use the  and  buttons to adjust it while cooking is in progress.
- Press  again or wait 5 seconds to return to cooking mode.

At the end of cooking

When the set target temperature for the temperature probe is reached, the heating elements are switched off and the appliance emits a series of beeps.

- Press a button on the programmer clock to stop the buzzer.
- Open the door.
- Remove the probe from the food and unplug it from the socket.
- Remove the food from the oven.
- Make sure that the protective cover is properly closed.

Cooking advice

General advice

- Use a fan assisted function to achieve consistent cooking at several levels.
- It is not possible to shorten cooking times by increasing the temperature (the food could be overcooked on the outside and undercooked on the inside).

Advice for cooking meat

- Cooking times vary according to the thickness and quality of the food and to consumer taste.
- Turn the food to brown on both sides.
- Use a meat thermometer when roasting meat, or simply press on the roast with a spoon. If it is hard, it is ready; if not, it needs to be cooked for a few more minutes.

Advice for cooking with the Grill

- Meat can be grilled even when it is put into the cold oven or into the preheated oven if you wish to change the effect of the cooking.
- With the Fan with grill function (if present), we recommend that you preheat the oven before grilling.
- We recommend placing the food at the centre of the rack.
- With the Grill function, we recommend that you set the temperature to the maximum value to optimise cooking.

Advice for cooking desserts/pastries and biscuits

- Use dark metal moulds: They help to absorb the heat better.
- The temperature and the cooking time depend on the quality and consistency of the dough.
- To check whether the dessert is cooked right through: At the end of the cooking time, put a toothpick into the highest point of the dessert. If the dough does not stick to the toothpick, the dessert is cooked.
- If the dessert collapses when it comes out of the oven, on the next occasion reduce the set temperature by about 10°C, selecting a longer cooking time if necessary.

Advice for cooking on two shelves:

- We recommend using two racks (they can be obtained from Authorised Assistance Centres).
- To facilitate the flow of air, place the

moulds/ovenware at the centre of the racks and make sure that their width/diameter does not exceed 30 cm.

- Position the racks keeping an empty shelf between them.
- Depending on the type of food and the increased quantity in the oven, cooking on two levels may take slightly longer compared to cooking on a single shelf.
- We suggest using the following functions when cooking on two shelves: CIRCULAIRE and CIRCULAIRE+BOTTOM.

Advice for defrosting and proving

- Place frozen foods without their packaging in a lidless container on the first shelf of the oven.
- Avoid overlapping the food.
- To defrost meat, use the rack placed on the second level and a tray on the first level. In this way, the liquid from the defrosting food drains away from the food.
- The most delicate parts can be covered with aluminium foil.
- For successful proving, a container of water should be placed in the bottom of the oven.

Cooking information table

Food	Weight (Kg)	Function	Shelf	Temp. (°C)	Time (minutes)	
Lasagne	3 - 4	STATIC	1	220 - 230	45 - 50	
Pasta bake	3 - 4	STATIC	1	220 - 230	45 - 50	
Veal roast	2	TURBO/CIRCULAIRE	2	180 - 190	90 - 100	
Pork loin	2	TURBO/CIRCULAIRE	2	180 - 190	70 - 80	
Sausages	1.5	FAN WITH GRILL	4	260	15	
Roast beef	1	TURBO/CIRCULAIRE	2	200	40 - 45	
Roast rabbit	1.5	CIRCULAIRE	2	180 - 190	70 - 80	
Turkey breast	3	TURBO/CIRCULAIRE	2	180 - 190	110 - 120	
Roast pork neck	2 - 3	TURBO/CIRCULAIRE	2	180 - 190	170 - 180	
Roast chicken	1.2	TURBO/CIRCULAIRE	2	180 - 190	65 - 70	
					1st surface	2nd surface
Pork chops	1.5	FAN WITH GRILL	4	260	15	5
Spare ribs	1.5	FAN WITH GRILL	4	260	10	10
Bacon	0.7	GRILL	5	260	7	8
Pork fillet	1.5	FAN WITH GRILL	4	260	10	5
Beef fillet	1	GRILL	5	260	10	7
Salmon trout	1.2	TURBO/CIRCULAIRE	2	150 - 160	35 - 40	
Monkfish	1.5	TURBO/CIRCULAIRE	2	160	60 - 65	
Turbot	1.5	TURBO/CIRCULAIRE	2	160	45 - 50	

The times indicated in the table do not include preheating times and are provided only as a guide.

Food	Weight (Kg)	Function	Shelf	Temp. (°C)	Time (minutes)
Pizza	1	TURBO/CIRCULAIRE	2	260	8 - 9
Bread	1	CIRCULAIRE	2	190 - 200	25 - 30
Focaccia	1	TURBO/CIRCULAIRE	2	180 - 190	20 - 25
Bundt cake	1	CIRCULAIRE	2	160	55 - 60
Tart	1	CIRCULAIRE	2	160	35 - 40
Ricotta cake	1	CIRCULAIRE	2	160 - 170	55 - 60
Jam tarts	1	TURBO/CIRCULAIRE	2	160	20 - 25
Paradise cake	1.2	CIRCULAIRE	2	160	55 - 60
Profiteroles	1.2	TURBO/CIRCULAIRE	2	180	80 - 90
Sponge cake	1	CIRCULAIRE	2	150 - 160	55 - 60
Rice pudding	1	TURBO/CIRCULAIRE	2	160	55 - 60
Brioches	0.6	CIRCULAIRE	2	160	30 - 35

The times indicated in the table do not include preheating times and are provided only as a guide.

Temperature probe-cooking information table (on some models only)

Type and cut of meat	Target temperature (°C)
Beef	
Roast beef: rare	50 - 53
Roast beef: medium	55 - 58
Roast beef: well done	65 - 70
Rib of beef: rare*	50
Rib of beef: medium*	58
Rib of beef: well done*	70
Pork	
Roast loin	80 - 85
Shoulder	80 - 85
Sausages**	75 - 80
Veal	
Veal roast	75 - 80
Poultry	
Whole chicken	80 - 85
Whole turkey	80 - 85
Roast turkey (whole or breast)	80 - 85
Lamb	

Type and cut of meat	Target temperature (°C)
Leg of lamb with bone (rare)	65
Leg of lamb with bone (well done)	75 - 80
Slow cooking	
Beef/ roast beef: rare***	50 - 54
Beef/ roast beef: medium***	55 - 60
* Cooking times vary according to the thickness of the fillet.	
** For sausages, it is recommended to select a suitable function to ensure they are well grilled.	
*** It is recommend to brown the meat on each side in a pan for a few minutes before putting it in the oven.	

Cooking information table (auxiliary oven)

Food	Weight (Kg)	Function	Shelf	Temp. (°C)	Time (minutes)	
Roast rabbit	1	STATIC	2	190 - 200	85 - 90	
Roast chicken	1	STATIC	2	190 - 200	80 - 85	
					1nd surface	2nd surface
Chops	0.8	GRILL	4	245	13	5
Hamburger	0.6	GRILL	4	245	7	3
Pork sausages	0.6	GRILL	4	245	15	-
Pork spare ribs	0.7	GRILL	4	245	30 - 35	-
Bacon	0.8	GRILL	4	245	10	3

The times indicated in the table do not include preheating times and are provided only as a guide.

CLEANING AND MAINTENANCE

Cleaning the appliance



See General safety instructions.

Cleaning the surfaces

To keep the surfaces in good condition, they should be cleaned regularly after use. Let them cool first.

Ordinary daily cleaning

Always and only use specific products that do not contain abrasives or chlorine-based acids. Pour the product onto a damp cloth and wipe the surface, rinse thoroughly and dry with a soft cloth or a microfibre cloth.

Food stains or residues

Do not use steel sponges and sharp scrapers as they will damage the surface.

Use normal, non-abrasive products and a wooden or plastic tool, if necessary. Rinse thoroughly and dry with a soft cloth or a microfibre cloth.

Do not allow residues of sugary foods (such as jam) to set inside the oven. If left to set for too long, they might damage the enamel lining of the oven.

Knobs



Do not use aggressive products containing alcohol or products for cleaning steel and glass when cleaning the knobs, as these products could cause permanent damage.

The knobs should be cleaned with a soft cloth dampened with lukewarm water, then dried carefully. They can be removed by pulling them out from their housings.

Cleaning the door

Door disassembly

For easier cleaning it is recommended to remove the door and place it on a tea towel. To remove the door proceed as follows:

1. Open the door completely and insert two pins into the holes on the hinges indicated in the figure.

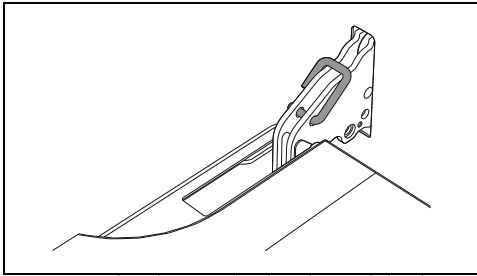

2. Grasp the door on both sides with both hands, lift it forming an angle of around 30° and remove it.

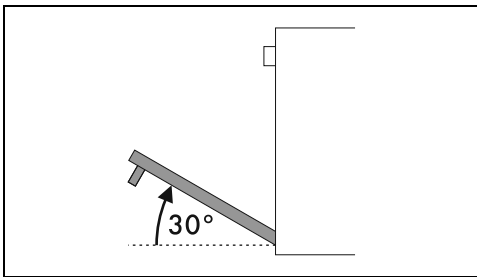

3. To reassemble the door, put the hinges in the relevant slots in the oven, making sure

that grooved sections **A** are resting completely in the slots.

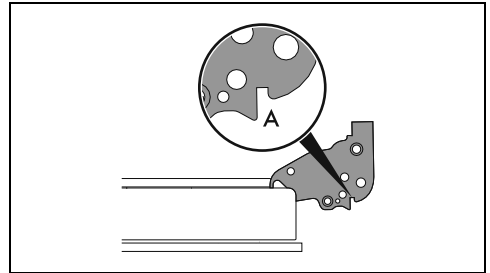

4. Lower the door and once it is in place remove the pins from the holes in the hinges.

Cleaning the door glazing

The glass in the door should always be kept thoroughly clean. Use absorbent kitchen roll. In case of stubborn dirt, wash with a damp sponge and an ordinary detergent.

Removing the internal glass panes

For easier cleaning the internal glass panes of the door can be removed.

1. Lock the door in place using the special pins.
2. Release the two rear pins of the internal glass panel by pulling the rear part of the panel gently upwards, following the movement indicated by the arrows 1.

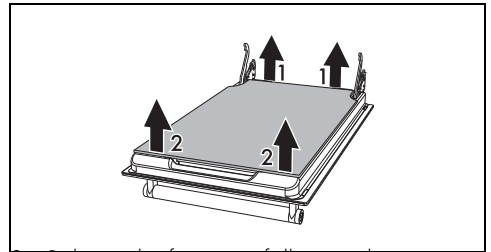
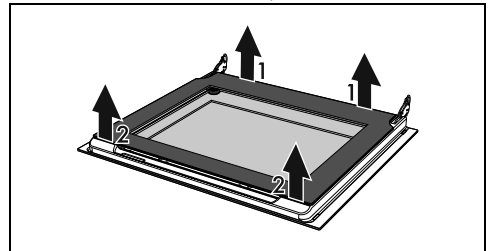

3. Release the front pins following the movement indicated by the arrows 2.

4. Then remove the internal glass panel from its seat.

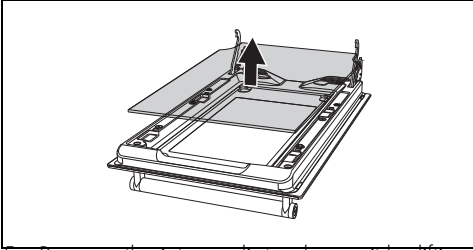
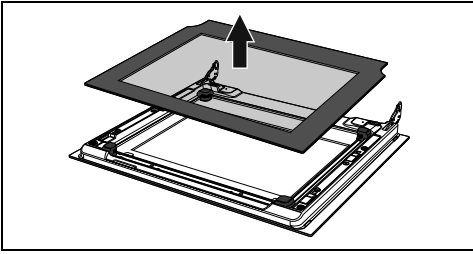

5. Remove the intermediate glass unit by lifting it upwards.

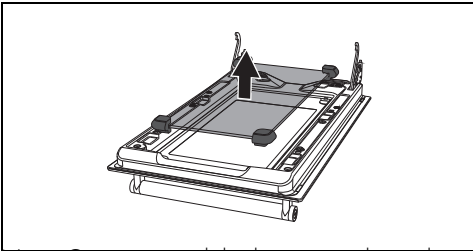
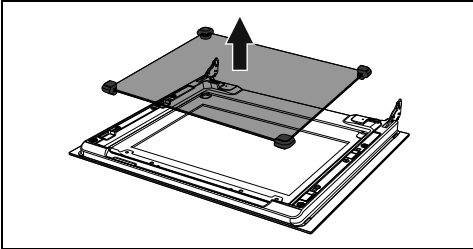

Note: On some models, the intermediate glass unit of the main oven door consists of two glass panels.

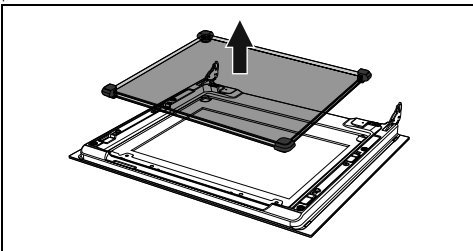

6. Clean the external glass pane and the panes removed previously.

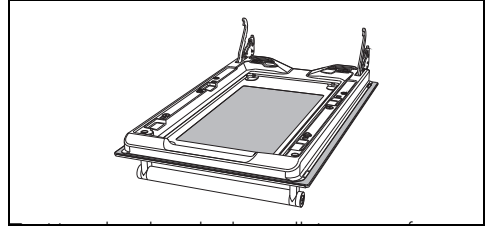
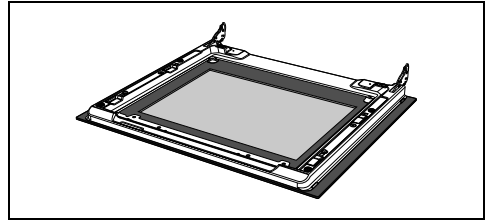

7. Use absorbent kitchen roll. In case of stubborn dirt, wash with a damp sponge and neutral detergent.

8. Reinstall the intermediate glass unit and reposition the internal glass panel.

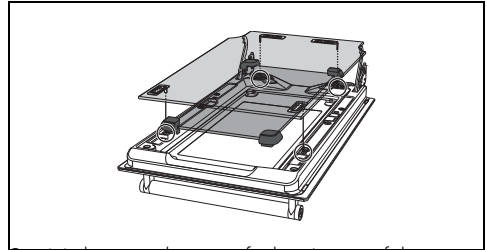
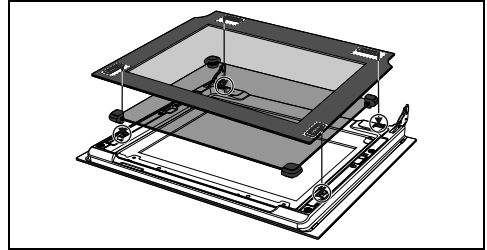

9. Make sure that you fit the 4 pins of the internal glass panel properly into their seats on both doors.

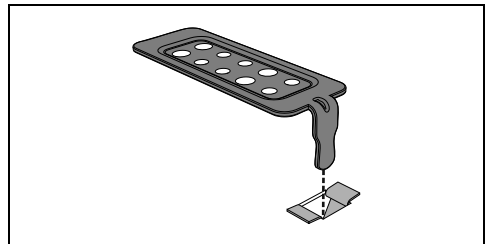

Cleaning the oven cavity

In order to keep your oven in the best possible condition, clean it regularly after letting it cool down.

Avoid letting food residue dry inside the oven cavity, as this could damage the enamel.

Take out all removable parts before cleaning. For easier cleaning, it is recommended to remove:

- the door;
- The rack/tray support frames.



In the event you are using specific cleaning products, we recommend running the oven at maximum temperature for 15-20 minutes in order to eliminate any residue.

Drying

Cooking food generates moisture inside the appliance. This is a normal phenomenon and does not affect the appliance's operation in any way.

Each time you finish cooking:

1. Let the appliance cool down.
2. Remove any dirt from inside the appliance.
3. Dry the interior of the appliance with a soft cloth.
4. Leave the door open until the inside of the appliance has dried completely.

Removing racks/trays support frames

Removing the rack/tray support frames enables the sides to be cleaned more easily.

To remove the rack/tray support frames:

- Pull the frame towards the inside of the oven cavity to unhook it from its groove A, then slide it out of the seats B at the back.

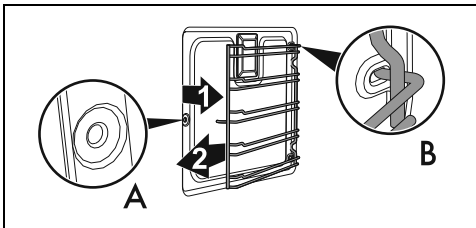

- When cleaning is complete, repeat the above procedures to put the rack/tray support frames back in.

Cleaning the probe (on some models only)

After each use, the temperature probe must be cleaned after it has cooled down. Clean the tip of the temperature probe (metal part) with

water, neutral dish soap and a soft sponge.

Clean the rest with a soft damp cloth.

Do not wash it in a dishwasher as it could damage the electrical components of the plug.

Dry thoroughly after cleaning.

Pyrolytic function (on some models only)



See General safety instructions.



Pyrolytic cleaning is an automatic high-temperature cleaning procedure which causes dirt to dissolve. Thanks to this process, it is possible to clean the inside of the oven very easily.

Preliminary operations

Before starting the pyrolytic cycle:

- Clean the internal glass pane following the usual cleaning instructions.
- Remove any food residues or large spills from previous cooking operations from the inside of the oven.
- Completely remove all accessories from inside the oven.
- For very stubborn encrustations spray an oven cleaning product onto the glass (read the warnings on the product); leave for 60 minutes, then rinse and dry the glass using kitchen roll or a microfibre cloth.
- Remove the temperature probe, if present.
- Remove the rack/tray support frames.
- Close the door.

Pyrolytic function setting

1. Turn the function knob to **P**.

A **dur** appears on the display, alternating with the duration of the Pyrolytic cycle

P **2:30** (factory set to 2 hours 30 minutes).

2. Press the increase **+** and decrease **-** buttons to set the duration of the Pyrolytic cycle.



Recommended pyrolytic cycle duration:

- Light dirt: 2:00
- Medium dirt: 2:30
- Heavy dirt: 3:00

3. Press the clock button **🕒** to confirm the settings.

The preheating for the Pyrolytic cycle starts after a few seconds:

- the **P** symbol on the display and the Pyrolytic cycle light come on;
- the display shows the time left until the end of the cleaning cycle **2:29**;
- the **🔒** symbol on the display flashes.

A few minutes after preheating starts, the **🔒** symbol on the display comes on (steadily) to indicate that the door is locked by a device that prevents it from being opened.

 It is not possible to select any function once the door lock device has been activated.

 If the function knob is turned to another function, the display shows an error message **Er 04**.

Cleaning process

The Pyrolytic cycle starts automatically at the end of the preheating phase:

- the indicator light turns off (its regular switching on and off indicates that the temperature inside the oven is being kept constant);
- the **🔥** symbol lights up (steadily) on the display to indicate that the pyrolytic cycle is in progress.
- The Pyrolytic cycle indicator light and the **P** and **🔒** symbols on the display remain on.

 During the first Pyrolytic cycle, unpleasant odours may occur due to the normal evaporation of oily manufacturing substances. This is an absolutely normal phenomenon which disappears after the first pyrolytic cycle.

 During the pyrolytic cycle the fans produce a more intense level of noise due to a greater rotation speed. This is an absolutely normal operation, intended to provide more effective heat dispersal. At the end of the pyrolytic cycle, the fans will continue to operate for long enough to avoid overheating the walls of adjacent units and the front of the oven.

End of pyrolytic cycle

At the end the Pyrolytic cycle:

- the heating elements are deactivated;
 - **End** flashes on the display;
 - a buzzer will sound that can be deactivated pressing any button on the display;
 - the **🔥** symbol and the thermostat indicator light switch off.
1. Turn the function knob to 0 to exit from the function.

The **🔒** symbol on the display remains lit until the temperature inside the oven returns to a safe level (and the door lock is deactivated).

2. Wait for the oven to cool down.
3. After the **🔒** symbol turns off, open the door and collect any residues that may have been deposited inside the oven using a damp microfibre cloth.

 We recommend wearing rubber gloves for these operations.

 We recommend removing the door in order to make the manual cleaning of the parts that are difficult to reach easier.

 If the pyrolytic cycle gives unsatisfactory results at minimum duration, it is recommended to set a longer time for subsequent cleaning cycles.

Programmed pyrolytic cycle



 Just like normal cooking functions, it is also possible to set an end time for the Pyrolytic function.

To program a Pyrolytic cycle:

1. Turn the function knob to **P**.
- A dur** appears on the display, alternating with the duration of the Pyrolytic cycle **2:30**.
2. Press the increase **+** and decrease **-** buttons to set the duration of the Pyrolytic cycle.
 3. Press the clock button **🕒**.

End will appear on the display alternating with the current time plus the duration

of the previously set Pyrolytic cycle.

- Press the  or  buttons to set the function end time.
- Press the clock button  or wait for a few seconds to activate the function.

The current time appears on the display and the symbol  flashes to indicate that the appliance is waiting to start the Pyrolysis cycle and finish it at the time set by the user.

Extraordinary maintenance

Seal maintenance tips

The seal should be soft and elastic.

- To keep the seal clean, use a non-abrasive sponge and wash with lukewarm water.

Replacing the internal light bulb

 **Power voltage**
Danger of electrocution

- Unplug the appliance.
 - Wear protective gloves.
- Completely remove all accessories from inside the oven.
 - Remove the rack/tray support frames.
 - Use a tool (e.g. a spoon) to remove the bulb cover.

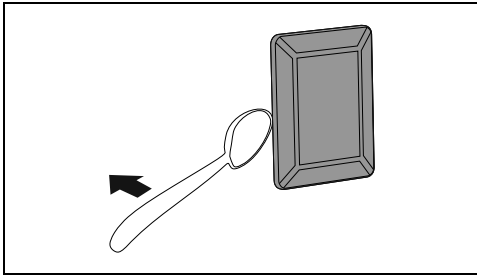

 Take care not to scratch the enamel of the oven cavity wall.

- Slide out and remove the light bulb.

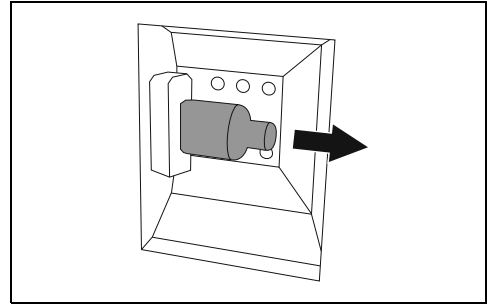

Do not touch the halogen light bulb directly with your fingers, use an insulating material.

- Replace the light bulb with one of the same type (40 W).
- Refit the cover. Ensure the moulded part of the glass (A) is facing the door.

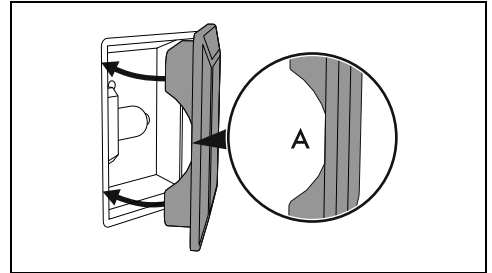

- Press the cover completely down so that it attaches perfectly to the bulb support.

Replacing the interior light bulb (auxiliary oven)

 **Power voltage**
Danger of electrocution

- Unplug the appliance.
 - Use protective gloves.
- Unscrew the protective cover A by turning it anti-clockwise.
 - Replace the bulb B with one of the same type (25 W). Use only oven bulbs (T 300°C).

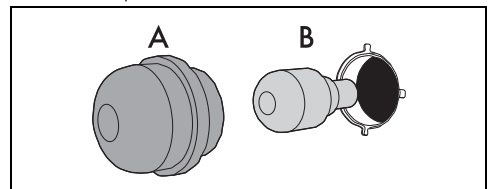

3. Reinstall the protective cover A.

INSTALLATION

 The appliance must be installed by a qualified technician and according to the regulations in force.

 Appliance factory set for: natural gas G20 at a pressure of 20 mbar.

Gas connection

 See General safety instructions.

Connection to the gas mains can be made using a continuous wall steel hose in compliance with the guidelines established by the standards in force. To use other types of gas, see the chapter "Adaptation to different types of gas". The appliance's gas connector has a 1/2" external thread (ISO 228-1).

Positioning

 See General safety instructions.

Depending on the type of installation, this appliance belongs to classes:

Class 1	Free-standing
Class 2 - subclass 1	Built-in

The appliance can be placed against walls that are higher than the work surface, at a minimum distance of X mm from the side of the appliance. Any wall units installed above the appliance's worktop must be positioned at least Y mm from it.

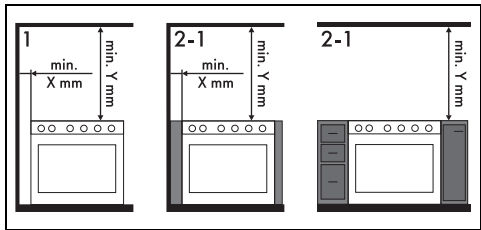

X	150 mm
Y	750 mm

 If a hood is installed above the appliance, refer to the hood instructions manual to make sure the correct clearance is left.

Connection with a rubber hose

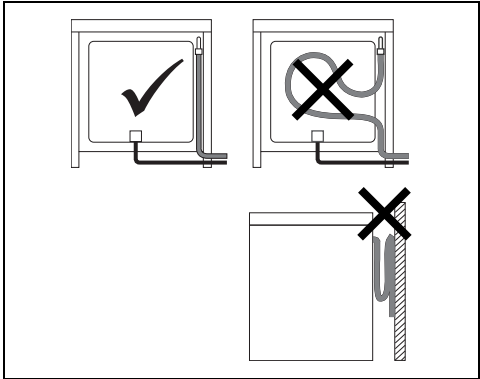

Verify that all following conditions are met:

- The hose is attached to the hose connector with safety clamps
- No part of the hose is in contact with hot walls (max. 50 °C)
- The hose is not under traction or tension and has no kinks or twists
- The hose is not in contact with sharp objects or sharp corners
- If the hose is not perfectly airtight and leaks gas, do not try to repair it; replace it with a new hose
- verify that the hose is not past its expiry date (serigraphed on the hose itself).

 Connection using a rubber hose complying with current standards is only permitted if the hose can be inspected along its entire length.

 The inside diameter of the hose must be 8 mm for LPG and 13 mm for Natural gas and Town gas.

Make the connection to the gas mains using a rubber hose whose specifications comply with current standards (verify that the reference

standard is stamped on the hose).

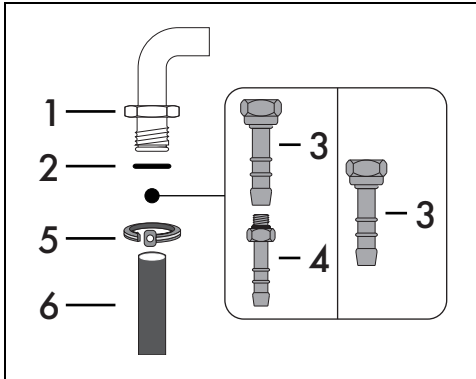

Carefully screw the hose connector 3 onto the appliance's gas connector 1 (1/2" thread ISO 228-1), placing the seal 2 between them. Hose connector 4 can also be screwed to hose connector 3, depending on the diameter of the gas hose used.

After tightening the hose connector(s), push gas hose 6 onto the hose connector and secure it with the clamp 5, which must be compliant with current regulations.

Connection with a steel hose

Make the connection to the gas mains using a continuous wall steel hose whose specifications comply with the applicable standard.

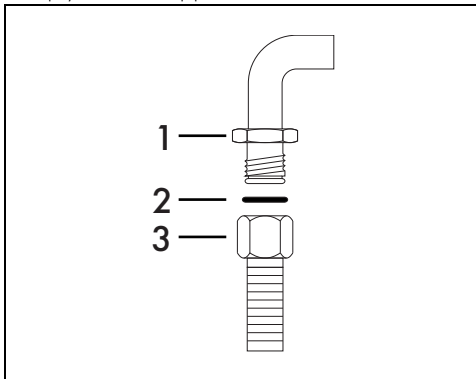

Carefully screw the connector 3 to the gas connector 1 of the appliance, placing the seal 2 between them.

Connection with a steel hose with bayonet fitting

Carry out the connection to the gas mains using a steel hose with bayonet fitting compliant with

B.S. 669.

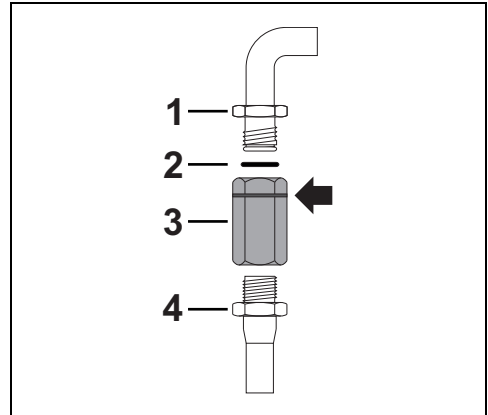

Apply insulating material to the thread of the gas hose connector 4 and screw the adapter 3 onto it. Screw the assembly onto the movable connector 1 of the appliance, inserting the seal provided 2 between them.

Connection with a steel hose with conical fitting

Make the connection to the gas mains using a continuous wall steel hose whose specifications comply with the applicable standard.

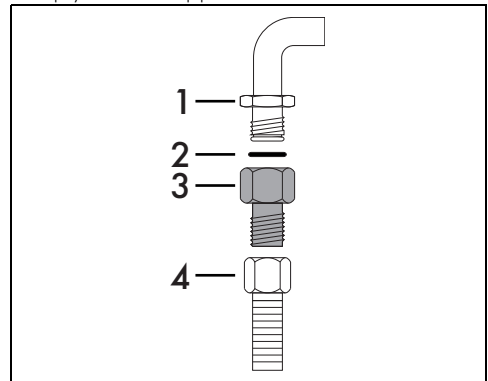

Carefully screw the hose connector 3 to the appliance's gas connector 1 (1/2" thread ISO 228-1), placing the seal 2, provided, between them. Apply insulating material to the thread of connector 3 and then screw the steel hose 4 onto the connector 3.

Connection to LPG

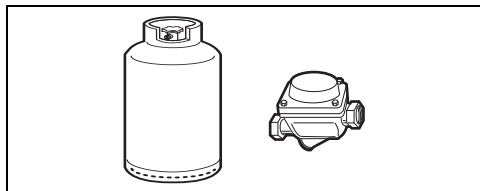

Use a pressure regulator and make the connection on the gas cylinder following the guidelines set out in the standards in force.

The supply pressure must comply with the values indicated in the "Burner and nozzle characteristics table".

Room ventilation

The appliance should be installed in rooms that have a permanent air supply in accordance with the standards in force. The room where the appliance is installed must have enough air flow for the regular combustion of gas and the necessary air change in the room itself. The air vents, protected by grilles, must be the right size to comply with current regulations and positioned so that no part of them is obstructed, not even partially.

The room must be kept adequately ventilated in order to eliminate the heat and humidity produced by cooking: In particular, after prolonged use, you are recommended to open a window or to increase the speed of any fans.

Extraction of the combustion products

The combustion products may be extracted by means of hoods connected to a natural draught chimney whose efficiency is certain or via forced extraction. An efficient extraction system requires precision planning by a specialist qualified in this area and must comply with the positions and clearances indicated by the applicable standards.

When the job is complete, the installer must

issue a certificate of conformity.

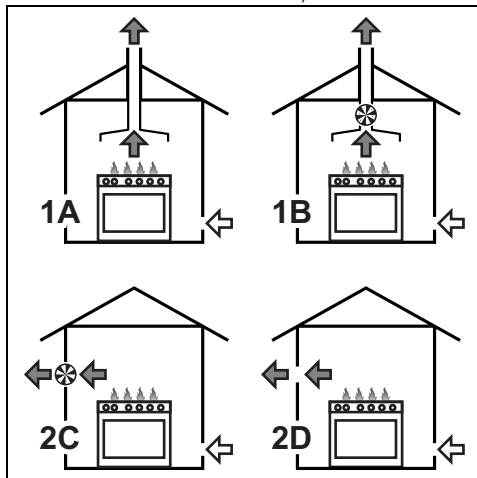

- 1 Extraction using a hood
- 2 Extraction without a hood
- A Extraction with a single natural draught chimney
- B Extraction with a single chimney with extractor fan
- C Extraction directly outdoors with wall- or window-mounted extractor fan
- D Extraction directly outdoors through wall



← Combustion products



Extractor fan

Adaptation to different types of gas

In case of operation with other types of gas, the burner nozzles must be changed and the minimum flame adjusted on the gas cocks.

Replacing nozzles

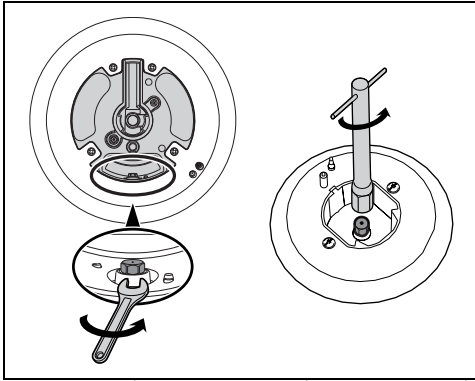

1. Remove the pan supports, burner caps and flame-spreader crowns to access the burner cups.
2. Replace the nozzles using a 7-mm wrench according to the type of gas to be used (see the "Burner and nozzle characteristics table").
3. Replace the burners in their respective housings.

Adjusting the minimum setting for LPG

Tighten the screw located at the side of the cock spindle clockwise all the way.



Following adjustment to a gas other than the one originally set in the factory, replace the gas setting label on the appliance with the one corresponding to the new gas. The label is inserted inside the nozzle pack (where present).

Adjusting the minimum setting for natural or town gas

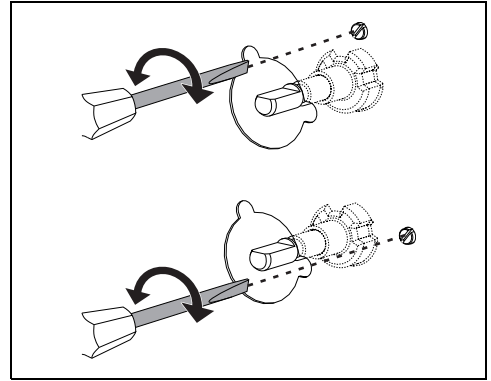

Light the burner and turn it to the minimum position. Extract the gas cock knob and turn the adjustment screw next to the gas cock spindle (depending on the model) until the correct minimum flame is achieved.

Refit the knob and verify that the burner flame is stable. Turn the knob rapidly from the maximum to the minimum setting; The flame should not go out. Repeat the operation on all gas cocks.

Lubricating the gas cocks

Over time the gas cocks may become difficult to turn and get blocked. Clean them internally and replace the lubrication grease.



Lubrication of the gas cocks should be performed by a specialised technician.

Burner and nozzle characteristics tables

1	Natural Gas G20 - 20 mbar	AUX	SR	R	UR2
	Rated heating capacity (kW)	1.0	1.8	2.9	4.2
	Nozzle diameter (1/100 mm)	72	97	115	145
	Pre-chamber (printed on nozzle)	(X)	(Z)	(Y)	(F3)
	Reduced flow rate (W)	400	500	800	1200
2	Natural Gas G20 - 25 mbar	AUX	SR	R	UR2
	Rated heating capacity (kW)	1.1	1.8	2.9	4.2
	Nozzle diameter (1/100 mm)	72	94	110	145
	Pre-chamber (printed on nozzle)	(X)	(Z)	(H8)	(H3)
	Reduced flow rate (W)	400	500	800	1200
3	Natural Gas G25.1 - 25 mbar	AUX	SR	R	UR2
	Rated heating capacity (kW)	1.1	1.8	3.0	4.1
	Nozzle diameter (1/100 mm)	77	100	134	152
	Pre-chamber (printed on nozzle)	(F1)	(Y)	(F3)	(F3)
	Reduced flow rate (W)	400	500	800	1200

4 Natural Gas G2.350 - 13 mbar	AUX	SR	R	UR2
Rated heating capacity (kW)	1.0	1.75	2.9	3.7
Nozzle diameter (1/100 mm)	94	120	165	190
Pre-chamber (printed on nozzle)	(Y)	(Y)	(F3)	(F3)
Reduced flow rate (W)	400	500	800	1200
5 LPG G30/31 - 30/37 mbar	AUX	SR	R	UR2
Rated heating capacity (kW)	1.0	1.8	3.0	4.0
Nozzle diameter (1/100 mm)	50	65	85	100
Pre-chamber (printed on nozzle)	-	-	-	-
Reduced flow rate (W)	400	500	800	1300
Rated flow rate G30 (g/h)	73	131	218	291
Rated flow rate G31 (g/h)	71	129	214	286
6 LPG G30/31 - 37 mbar	AUX	SR	R	UR2
Rated heating capacity (kW)	1.1	1.9	3.0	4.2
Nozzle diameter (1/100 mm)	50	65	81	95
Pre-chamber (printed on nozzle)	-	-	-	-
Reduced flow rate (W)	450	550	900	1500
Rated flow rate G30 (g/h)	80	138	218	305
Rated flow rate G31 (g/h)	79	136	214	300
7 Town gas G110 – 8 mbar	AUX	SR	R	UR2
Rated heating capacity (kW)	1.0	1.75	2.8	3.3
Nozzle diameter (1/100 mm)	145	185	260	340
Pre-chamber (printed on nozzle)	(/8)	(/2)	(/3)	0190
Reduced flow rate (W)	400	500	800	1000

The nozzles not provided are available at Authorised Service Centres.

Appliance overall dimensions

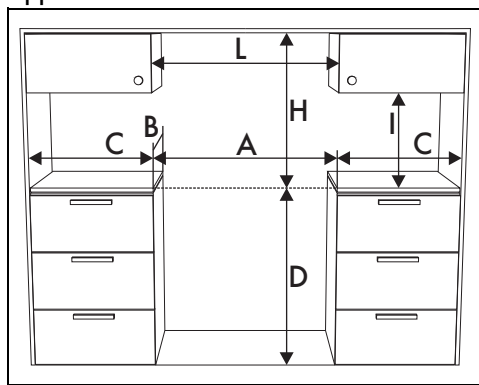

A	900 mm
B	600 mm
C ¹	min. 150 mm
D	879 ÷ 919 mm
H	750 mm
I	450 mm
L ²	900 mm

¹ Minimum distance from side walls or other flammable material.

² Minimum cabinet width (=A)

Appliance dimensions

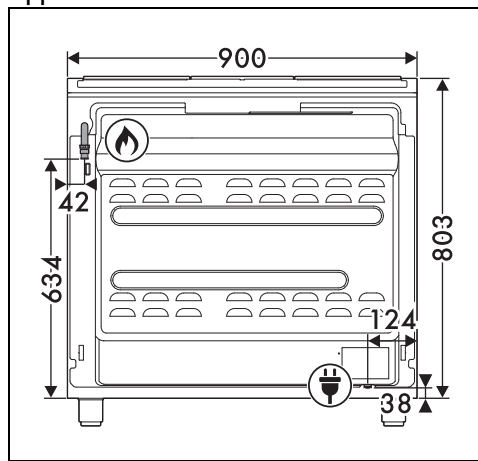

Position of gas connection



Position of electrical connection

Levelling the appliance



See General safety instructions.

The appliance must be level on the floor in order to ensure greater stability.

After making the gas and electrical connections, screw on the four legs supplied with the appliance (1). Screw or unscrew the feet at the bottom until the appliance is stable and level on the floor (2).

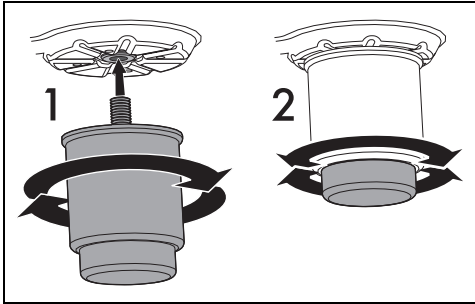

Assembling the upstand

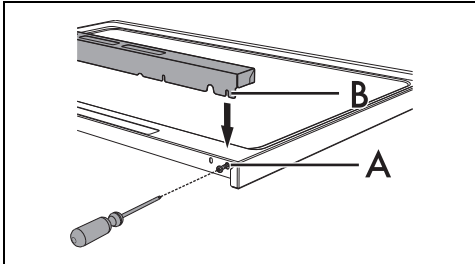

The upstand must always be positioned and secured correctly on the appliance.

1. Loosen the 2 screws (A) on the back of the hob using a screwdriver (only loosen the outermost ones).
2. Place the upstand on the hob.
3. Align the slots of the upstand (B) with the screws (A).



The upstand provided is an integral part of the product. It must be fastened to the appliance prior to installation.

Fastening to the wall



The symbols above indicate the danger if the anti-tip are not installed devices and the importance of their correct installation.



The anti-tip devices must be installed in order to prevent the appliance from tipping over.

1. Screw the wall fastening plate to the rear of the appliance.

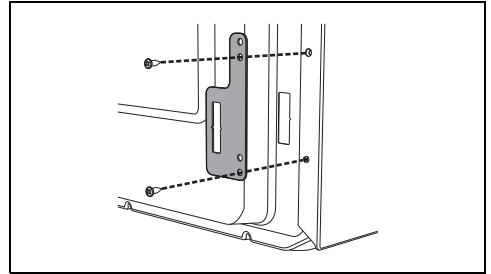

2. Adjust the height of the 4 legs.
3. Assemble the fastening bracket.

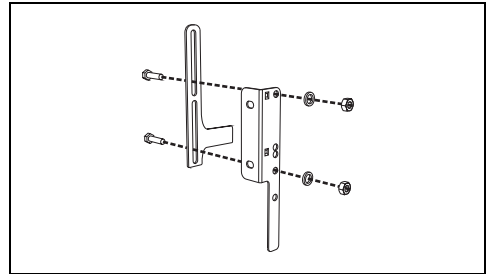

4. Align the base of the hook on the fastening bracket with the base of the slot on the wall fastening plate.

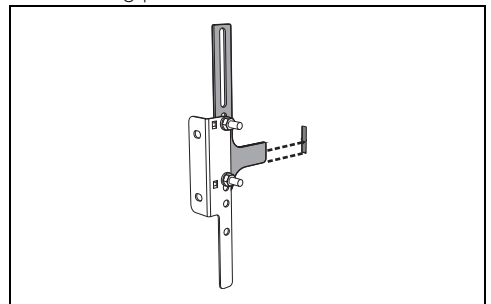

5. Align the base of the fastening bracket with the ground and tighten the screws to fix the measurements.

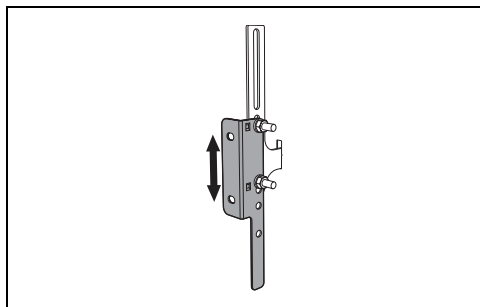

6. Consider a distance of 50 mm from the side of the appliance to the bracket holes.

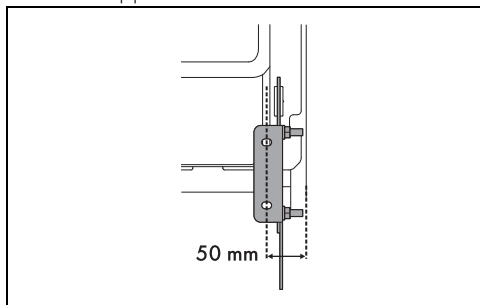

7. Move the bracket onto the wall and mark the position of the holes to be drilled in the wall.

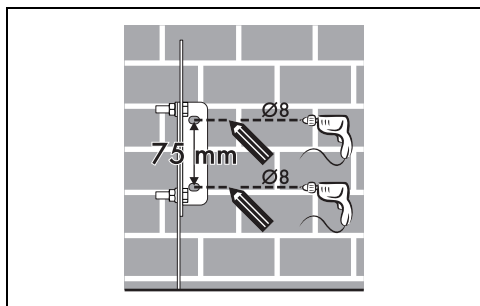

8. After drilling the holes in the wall, use wall plugs and screws to fasten the bracket to the wall.

9. Push the cooker towards the wall, and at the same time insert the bracket in the plate fastened to the rear of the appliance.

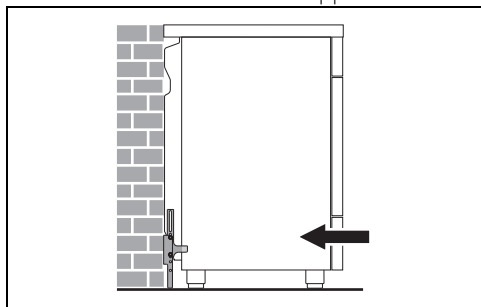

Electrical connection



See General safety instructions.

General information

Check the mains characteristics against the data indicated on the plate.

The identification plate bearing the technical data, serial number and brand name is visibly positioned on the appliance.

Do not remove this plate for any reason.

The appliance must be connected to ground using a wire that is at least 20 mm longer than the other wires.

The appliance can work in the following modes:

220-240 V 2 \sim

3 x 6 mm²

three-core cable

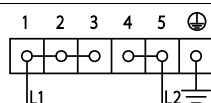

220-240 V 3 \sim

4 x 6 mm²

four-core cable

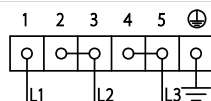

220-240 V 1N \sim

3 x 6 mm²

three-core cable

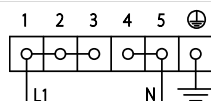

380-415 V 2N \sim

4 x 6 mm²

four-core cable

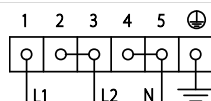

380-415 V 3N \sim

5 x 2.5 mm²

five-core cable

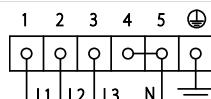



The values indicated refer to the cross-section of the internal conductor.



The aforementioned power cables are sized taking into account the coincidence factor (in compliance with standard EN 60335-2-6).

Fixed connection

Fit the power line with an all-pole circuit breaker with a contact separation distance sufficient to provide complete disconnection in category III overvoltage conditions, pursuant to installation regulations.

For the Australian/New Zealand market:

The circuit breaker incorporated in the fixed connection must comply with AS/NZS 3000.

Accessing the terminal board

To connect the power supply cable, you have to access the terminal board on the rear casing

1. Remove the screws fastening the plate to the rear casing

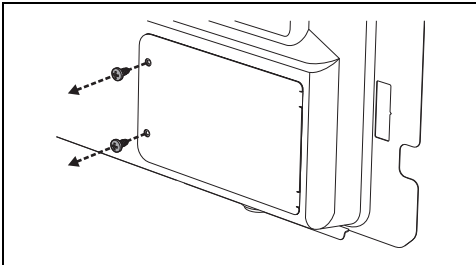

2. Gently rotate the plate and remove it from its seat.

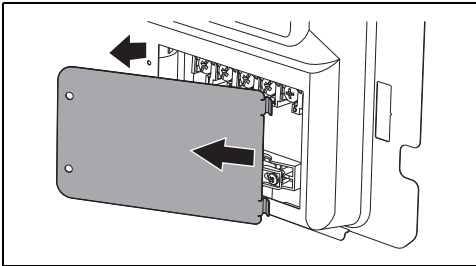

3. Proceed with installation of the power supply cable.

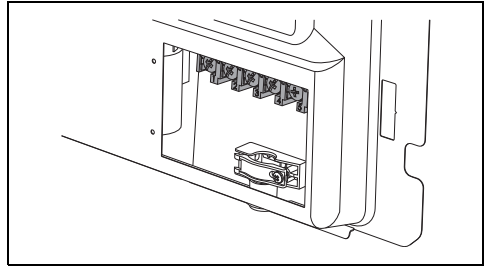

It is recommended to slacken off the cable clamp screw before installing the power supply cable.

4. When finished, replace the plate on the rear casing and secure it using the screws that were previously removed.

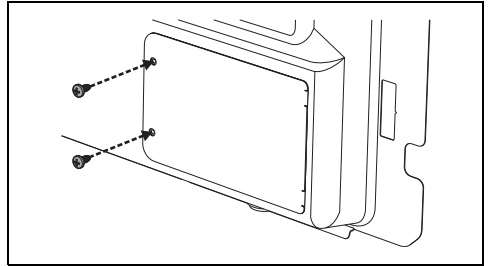

Instructions for the installer

- If you use a plug (if present) to connect to the power supply, the plug must be accessible after installation.
- Do not bend or trap the power cable.
- The appliance must be installed according to the installation diagrams.
- If the appliance does not work correctly after having carried out all the checks, contact your local Authorised Service Centre.
- Once the appliance has been installed, please explain to the user how to use it correctly.