

CIX6540ACB
CIX6540ACM
CIX6540ACW

EN User Manual | **Cooker**



Welcome to AEG! Thank you for choosing our appliance.



Get usage advice, brochures, troubleshooting, service and repair information:
www.aeg.com/support

Subject to change without notice.

CONTENTS

1. SAFETY INFORMATION.....	2
2. SAFETY INSTRUCTIONS.....	5
3. INSTALLATION.....	7
4. PRODUCT DESCRIPTION.....	9
5. BEFORE FIRST USE.....	10
6. HOB - DAILY USE.....	10
7. HOB - HINTS AND TIPS.....	16
8. HOB - CARE AND CLEANING.....	18
9. OVEN - DAILY USE.....	18
10. OVEN - CLOCK FUNCTIONS.....	20
11. OVEN - HINTS AND TIPS.....	21
12. OVEN - CARE AND CLEANING.....	23
13. TROUBLESHOOTING.....	25
14. ENERGY EFFICIENCY.....	27
15. ENVIRONMENTAL CONCERNS.....	29

1. ⚠ SAFETY INFORMATION

Before the installation and use of the appliance, carefully read the supplied instructions. The manufacturer is not responsible for any injuries or damage that are the result of incorrect installation or usage. Always keep the instructions in a safe and accessible location for future reference.

1.1 Children and vulnerable people safety

- This appliance can be used by children aged from 8 years and above and persons with reduced physical, sensory or mental capabilities or lack of experience and knowledge if they have been given supervision or instruction concerning the use of the appliance in a safe way and understand the hazards involved. Children of less than 8 years of age and persons with very extensive and complex disabilities shall

be kept away from the appliance unless continuously supervised.

- Children should be supervised to ensure that they do not play with the appliance.
- Keep all packaging away from children and dispose of it appropriately.
- **WARNING:** The appliance and its accessible parts become hot during use. Keep children and pets away from the appliance when in use and when cooling down.
- If the appliance has a child safety device, it should be activated.
- Children shall not carry out cleaning and user maintenance of the appliance without supervision.

1.2 General Safety

- This appliance is for cooking purposes only.
- This appliance is designed for single household domestic use in an indoor environment.
- This appliance may be used in offices, hotel guest rooms, bed & breakfast guest rooms, farm guest houses and other similar accommodation where such use does not exceed (average) domestic usage levels.
- Only a qualified person must install this appliance and replace the cable.
- This appliance must be connected to the mains with a H05VV-F type cable to withstand the temperature of the rear panel.
- This appliance is intended for use up to an altitude of 2000 m above sea level.
- This appliance is not intended to be used on ships, boats or vessels.
- Do not install the appliance behind a decorative door in order to avoid overheating.
- Do not install the appliance on a platform.
- Do not operate the appliance by means of an external timer or separate remote-control system.

- **WARNING:** Unattended cooking on a hob with fat or oil can be dangerous and may result in fire.
- Never use water to extinguish the cooking fire. Switch off the appliance and cover flames with e.g. a fire blanket or lid.
- **CAUTION:** The cooking process has to be supervised. A short term cooking process has to be supervised continuously.
- **WARNING:** Danger of fire: Do not store items on the cooking surfaces.
- Do not use a steam cleaner to clean the appliance.
- Do not use harsh abrasive cleaners or sharp metal scrapers to clean the glass door or the glass of hinged lids of the hob since they can scratch the surface, which may result in shattering of the glass.
- Metallic objects such as knives, forks, spoons and lids should not be placed on the hob surface since they can get hot.
- **WARNING:** If the surface is cracked, switch off the appliance to avoid the possibility of electric shock. In case the appliance is connected to the mains directly using junction box, remove the fuse to disconnect the appliance from power supply. In either case contact the Authorised Service Centre.
- After use, switch off the hob element by its control and do not rely on the pan detector.
- **WARNING:** The appliance and its accessible parts become hot during use. Care should be taken to avoid touching heating elements.
- Always use oven gloves to remove or insert accessories or ovenware.
- Before maintenance, cut the power supply.
- **WARNING:** Ensure that the appliance is switched off before replacing the lamp to avoid the possibility of electric shock.
- If the mains power supply cable is damaged, it must be replaced by the manufacturer, its Authorised Service Centre or similarly qualified persons to avoid an electrical hazard.

- To remove the shelf supports first pull the front of the shelf support and then the rear end away from the side walls. Install the shelf supports in the opposite sequence.
- The means for disconnection must be incorporated in the fixed wiring in accordance with the wiring rules.
- **WARNING:** Use only hob guards designed by the manufacturer of the cooking appliance or indicated by the manufacturer of the appliance in the instructions for use as suitable or hob guards incorporated in the appliance. The use of inappropriate guards can cause accidents.

2. SAFETY INSTRUCTIONS

2.1 Installation

WARNING!

Only a qualified person must install this appliance.

- Remove all the packaging.
- Do not install or use a damaged appliance.
- Follow the installation instructions supplied with the appliance.
- Always take care when moving the appliance as it is heavy. Always use safety gloves and enclosed footwear.
- Do not pull the appliance by the handle.
- The kitchen cabinet and the recess must have suitable dimensions.
- Keep the minimum distance from other appliances and units.
- Install the appliance in a safe and suitable place that meets installation requirements.
- Parts of the appliance carry current. Close the appliance with furniture to prevent touching the dangerous parts.
- The sides of the appliance must stay next to appliances or units with the same height.
- Do not install the appliance adjacent to a door or under a window. This prevents hot cookware to fall from the appliance when the door or the window is opened.
- Make sure to install a stabilizing means in order to prevent tipping of the appliance. Refer to Installation chapter.

2.2 Electrical Connection

WARNING!

Risk of fire and electric shock.

- All electrical connections should be made by a qualified electrician.
- The appliance must be earthed.
- Make sure that the parameters on the rating plate are compatible with the electrical ratings of the mains power supply.
- Always use a correctly installed shockproof socket.
- Do not use multi-plug adapters and extension cables.
- Do not let mains cables touch or come near the appliance door or the niche below the appliance, especially when it operates or the door is hot.
- The shock protection of live and insulated parts must be fastened in such a way that it cannot be removed without tools.
- Connect the mains plug to the mains socket only at the end of the installation. Make sure that there is access to the mains plug after the installation.
- If the mains socket is loose, do not connect the mains plug.
- Do not pull the mains cable to disconnect the appliance. Always pull the mains plug.
- Use only correct isolation devices: line protecting cut-outs, fuses (screw type fuses removed from the holder), earth leakage trips and contactors.

- The electrical installation must have an isolation device which lets you disconnect the appliance from the mains at all poles. The isolation device must have a contact opening width of minimum 3 mm.
- Fully close the appliance door before you connect the mains plug to the mains socket.

2.3 Use

WARNING!

Risk of injury and burns.
Risk of electrical shock.

- Do not change the specification of this appliance.
- Make sure that the ventilation openings are not blocked.
- Do not let the appliance stay unattended during operation.
- Deactivate the appliance after each use.
- Be careful when you open the appliance door while the appliance is in operation. Hot air can release.
- Do not operate the appliance with wet hands or when it has contact with water.
- Do not use the appliance as a work surface or as a storage surface.
- Users with a pacemaker must keep a distance of minimum 30 cm from the induction cooking zones when the appliance is in operation.
- Do not use aluminum foil or other materials between the cooking surface and the cookware, unless otherwise specified by the manufacturer of this appliance.
- Use only accessories recommended for this appliance by the manufacturer.
- Always use glass and jars approved for preserving purposes.

WARNING!

Risk of fire and explosion.

- Fats and oil when heated can release flammable vapours. Keep flames or heated objects away from fats and oils when you cook with them.
- The vapours that very hot oil releases can cause spontaneous combustion.

- Used oil, that can contain food remnants, can cause fire at a lower temperature than oil used for the first time.
- Do not put flammable products or items that are wet with flammable products in, near or on the appliance.
- Do not let sparks or open flames to come in contact with the appliance when you open the door.
- Open the appliance door carefully. The use of ingredients with alcohol can cause a mixture of alcohol and air.

WARNING!

Risk of damage to the appliance.

- To prevent damage or discoloration to the enamel:
 - do not put ovenware or other objects in the appliance directly on the bottom.
 - do not put aluminium foil directly on the bottom of cavity.
 - do not put water directly into the hot appliance.
 - do not keep moist dishes and food in the appliance after you finish the cooking.
 - be careful when you remove or install the accessories.
- Discoloration of the enamel or stainless steel has no effect on the performance of the appliance.
- Use a deep pan for moist cakes. Fruit juices cause stains that can be permanent.
- Do not keep hot cookware on the control panel.
- Do not let cookware boil dry.
- Be careful not to let objects or cookware fall on the appliance. The surface can be damaged.
- Do not activate the cooking zones with empty cookware or without cookware.
- Cookware made of cast iron, aluminium or with a damaged bottom can cause scratches. Always lift these objects up when you have to move them on the cooking surface.

2.4 Care and Cleaning

 **WARNING!**

Risk of injury, fire, or damage to the appliance.

- Before maintenance, deactivate the appliance.
Disconnect the mains plug from the mains socket.
- Make sure the appliance is cold. There is the risk that the glass panels can break.
- Replace immediately the door glass panels when they are damaged. Contact the Authorised Service Centre.
- Be careful when you remove the door from the appliance. The door is heavy!
- Fat and food remaining in the appliance can cause fire.
- Clean regularly the appliance to prevent the deterioration of the surface material.
- Make sure the cavity and the door are wiped dry after each use. Steam produced during the operation of the appliance condensates on cavity walls and can cause corrosion. To decrease the condensation operate the appliance for 10 minutes before cooking.
- Clean the appliance with a moist soft cloth. Use only neutral detergents. Do not use abrasive products, abrasive cleaning pads, solvents or metal objects.
- If you use an oven spray, follow the safety instructions on the packaging.
- Do not clean the catalytic enamel (if applicable) with any kind of detergent.

2.5 Internal lighting

 **WARNING!**

Risk of electric shock.

- Concerning the lamp(s) inside this product and spare part lamps sold separately: These lamps are intended to withstand extreme physical conditions in household appliances, such as temperature, vibration, humidity, or are intended to signal information about the operational status of the appliance. They are not intended to be used in other applications and are not suitable for household room illumination.
- This product contains a light source of energy efficiency class G.
- Use only lamps with the same specifications.

2.6 Service

- To repair the appliance contact the Authorised Service Centre.
- Use original spare parts only.

2.7 Disposal

 **WARNING!**

Risk of injury or suffocation.

- Contact your municipal authority for information on how to dispose of the appliance.
- Disconnect the appliance from the mains supply.
- Cut off the mains electrical cable close to the appliance and dispose of it.

3. INSTALLATION

 **WARNING!**

Refer to Safety chapters.

3.1 Technical data

Dimensions	
Height	894 - 912 mm
Width	600 mm

Dimensions

Depth 600 mm

3.2 Location of the appliance

You can install your freestanding appliance with cabinets on one or two sides and in the corner.

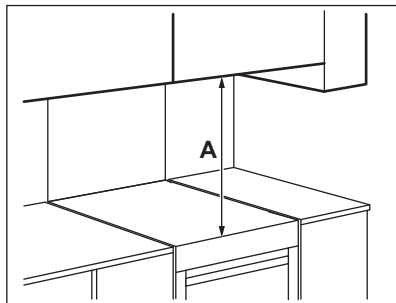

Minimum distances

Dimension	mm
A	650

3.3 Levelling of the appliance

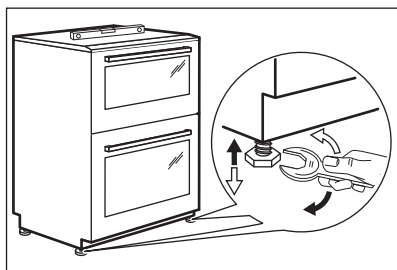

Use small feet on the bottom of appliance to set the appliance top surface level with other surfaces.

3.4 Electrical installation

⚠ WARNING!

The manufacturer is not responsible if you do not follow the safety precautions from Safety chapters.

This appliance is supplied without a main plug or a main cable.

Applicable types of cables for different phases:

Phase	Min. size cable
1	3x6.0 mm ²
3 with neutral	5x1.5 mm ²

⚠ WARNING!

The power cable must not touch the part of the appliance shaded in the illustration.

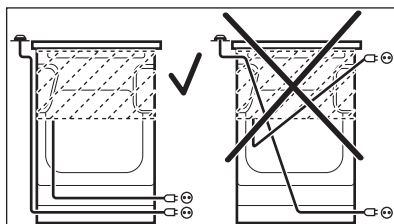

3.5 Covering terminal board

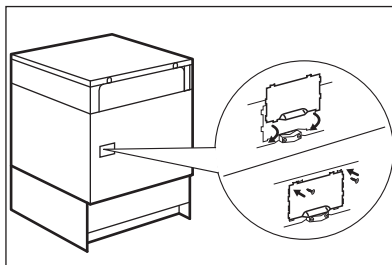

- The recommended cross-section area is six square millimetres (6 mm²).
- When you refit the mains terminal cover, make sure that the lower tabs are located inside the bottom edge of the aperture, before you fix the two screws into the top edge of the mains terminal cover.
- Make sure that the cover is securely fastened.

i

To open the cover of terminal board obey the procedure in opposite sequence.

4. PRODUCT DESCRIPTION

4.1 General overview

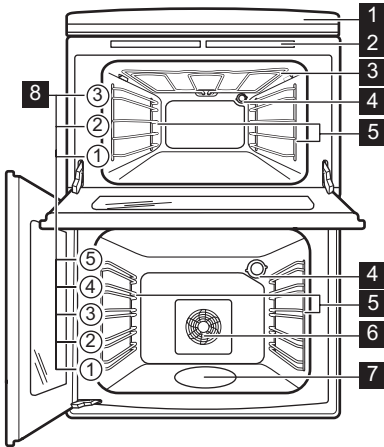

- 1 Control panel and hob
- 2 Air vents for the cooling fan
- 3 Heating element
- 4 Lamp
- 5 Shelf support, removable
- 6 Fan
- 7 Cavity embossment
- 8 Shelf positions

4.2 Hob overview

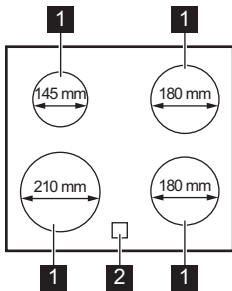

- 1 Induction cooking zone
- 2 Control Panel

4.3 Cooker control panel

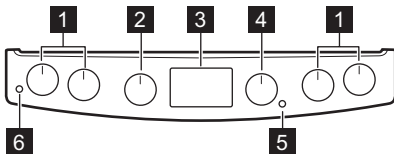

- 1 Knobs for the hob
- 2 Knob for the top oven functions
- 3 Display
- 4 Knob for the main oven functions
- 5 Temperature indicator / symbol for the main oven
- 6 Temperature indicator / symbol for the top oven

4.4 Accessories

- **Wire shelf**
For cookware, cake tins, roasts.
- **Grill- / Roasting pan**
To bake and roast or as pan to collect fat.
- **Trivet**
For roasting and grilling.



Use the trivet only with the Grill- / roasting pan.



5. BEFORE FIRST USE

WARNING!

Refer to Safety chapters.

5.1 Initial preheating and cleaning

Preheat both empty appliances before the first use and contact with food. Heat up one appliance at a time. The appliance can emit unpleasant smell and smoke. Ventilate the room during preheating. Set the functions listed below, if applicable.

1. Remove all accessories and removable shelf supports from the appliance.
2. Set the function  for main oven or **100 - 250** for top oven. Set the temperature to 250°C. Let the appliance operate for 1 h.
3. Set the function . Set the maximum temperature. Let the appliance operate for 15 min.
4. Turn off the appliance and wait until it is cold.
5. Clean the appliance and the accessories only with a microfibre cloth, warm water and a mild detergent.
6. Put the accessories and removable shelf supports back to their initial position.

5.2 Using the sensor fields

To activate the function press and hold the selected symbol on the display for at least 1 second.

5.3 Setting the time

You must set the time before you operate the oven.



Only the top oven works without the set time.

The  flashes when you connect the appliance to the electrical supply, when there was a power cut or when the timer is not set.

Press the **+** or **-** to set the correct time. After approximately five seconds, the flashing stops and the display shows the time of day you set.

5.4 Changing the time



You cannot change the time of day if any of the functions operates.

Press  again and again until the indicator for the Time of Day function flashes. To set a new time, refer to "Setting the time".

6. HOB - DAILY USE

WARNING!

Refer to Safety chapters.

6.1 Hob control panel

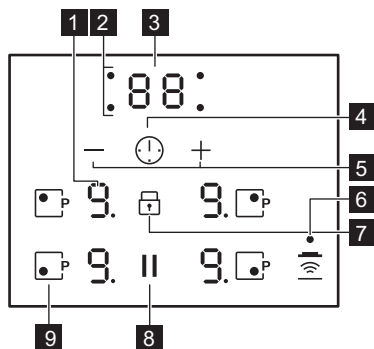

Use the sensor fields to operate the appliance. The displays, indicators and sounds tell which functions operate.

Sensor field	Function	Comment	
1	-	Heat setting display	To show the heat setting.
2	-	Timer indicators of cooking zones	To show for which zone you set the time.
3	-	Timer display	To show the time in minutes.
4	⌚	-	To select the cooking zone.
5	+ / -	-	To increase or decrease the time.
6	📶	Hob²Hood	To activate and deactivate the manual mode of the function.
7	🔒	Lock / Child safety device	To lock / unlock the control panel.
8	⏸	Pause	To activate and deactivate the function.
9	⚡	PowerBoost	To activate and deactivate the function.

6.2 Heat setting displays

Display	Description
0	The cooking zone is deactivated.
1 - 9 / 2 - 5	The cooking zone operates. The dot means a change by half of a heating level.
⏸	Pause operates.
R	Automatic heat up operates.

Display	Description
	PowerBoost operates.
+ digit	There is a malfunction.
	OptiHeat control (3 step Residual heat indicator): continue cooking / keep warm / residual heat.
	Lock / Child safety device operates.
	Incorrect or too small cookware or no cookware on the cooking zone.
	Automatic switch off operates.

6.3 OptiHeat control (3 step Residual heat indicator)

WARNING!

As long as the indicator is visible, there is a risk of burns from residual heat.

The induction cooking zones produce the heat necessary for the cooking process directly in the bottom of the cookware. The glass ceramic is heated by the heat of the cookware.

The indicators appear when a cooking zone is hot. They show the level of the residual heat for the cooking zones you are currently using:

- continue cooking,

- keep warm,

- residual heat.

The indicator may also appear:

- for the neighbouring cooking zones even if you are not using them,
- when hot cookware is placed on cold cooking zone,
- when the hob is deactivated but the cooking zone is still hot.

The indicator disappears when the cooking zone has cooled down.

6.4 The heat setting

Turn the knob for the heating functions to select a heating function. To deactivate it turn the knob to the off position **0**.

6.5 Automatic switch off

The function deactivates the hob automatically if:

- all cooking zones are deactivated,
- you do not set the heat setting after you activate the hob,
- you spill something or put something on the control panel for more than 10 seconds (a pan, a cloth, etc.). An acoustic signal sounds and the hob deactivates. Remove the object or clean the control panel.
- the hob gets too hot (e.g. when a saucepan boils dry). Let the cooking zone cool down before you use the hob again.
- you use incorrect cookware. The symbol comes on and the cooking zone deactivates automatically after 2 minutes.
- you do not deactivate a cooking zone or change the heat setting. After some time comes on and the hob deactivates.

The relation between the heat setting and the time after which the hob deactivates:

Heat setting	The hob deactivates after
1 - 2	6 hours

Heat setting	The hob deactivates after
3 - 4	5 hours
5	4 hours
6 - 9	1.5 hour

6.6 Automatic heat up

If you activate this function you can get a necessary heat setting faster. The function sets the highest heat setting for some time and then decreases to the correct heat setting.



To activate the function a cooking zone must be cold.

To activate the function for a cooking zone: turn the knob for a cooking zone to the **A** position. **P** shows on the display. Immediately set the correct heat setting.

To deactivate the function: turn the knob to the off position.

6.7 PowerBoost

This function makes more power available to the induction cooking zones. The function can be activated for the induction cooking zone only for a limited period of time. After this time the induction cooking zone automatically sets back to the highest heat setting.

To activate the function for a cooking zone: touch **P**. **P** comes on.

To deactivate the function: change the heat setting.

6.8 Timer

Count down timer

You can use this function to set how long the cooking zone should operate for a single cooking session.

First set the heat setting for the cooking zone then set the function.

To set the cooking zone: touch again and again until the indicator of a necessary cooking zone comes on.

To activate the function: touch **+** of the timer to set the time (00 - 99 minutes). When the indicator of the cooking zone starts to flash slowly the time counts down.

To see the remaining time: set the cooking zone with . The indicator of the cooking zone starts to flash quickly. The display shows the remaining time.

To change the time: set the cooking zone with . Touch **+** or **-**.

To deactivate the function: set the cooking zone with and touch **-**. The remaining time counts back to 00. The indicator of the cooking zone goes out.



When the time comes to an end, the sound operates and 00 flashes. The cooking zone deactivates.

To stop the sound: touch .

Count up timer

You can use this function to monitor how long the cooking zone operates.

To set the cooking zone: touch again and again until the indicator of a necessary cooking zone comes on.

To activate the function: touch **-** of the timer. **UP** comes on. When the indicator of the cooking zone starts to flash slowly the time counts up. The display switches between **UP** and counted time (minutes).



To see how long the cooking zone

operates: set the cooking zone with . The indicator of the cooking zone starts to flash quickly. The display shows how long the zone operates.

To deactivate the function: set the cooking zone with and touch **+** or **-**. The indicator of the cooking zone goes out.

Minute minder

You can use this function as a **Minute minder** when the hob is activated and the cooking zones do not operate. The heat setting display shows .

To activate the function: touch . Touch  or  of the timer to set the time. Cooking zones display deactivates automatically after 10 seconds. When the time comes to an end, the sound operates and **00** flashes.

To stop the sound: touch .

To deactivate the function: activate for a short time and deactivate left front cooking zone.





The function has no effect on the operation of the cooking zones.

6.9 Pause

This function sets all operating cooking zones to the lowest heat setting.

The function does not stop the timer functions.

- To activate the function:** press .  comes on. The heat setting is lowered to 1.
- To deactivate the function:** press . The previous heat setting appears.





If you change the heat setting, the function stops and the display shows the new heat setting.

6.10 Lock

You can lock the sensors on the hob while cooking zones operate.

Set the heat setting first.

To activate the function: touch .  comes on for 4 seconds. The Timer stays on.





To deactivate the function: touch . The previous heat setting comes on.







When you deactivate the hob, you also deactivate this function.



6.11 Child safety device

This function prevents an accidental operation of the hob.





To activate the function: the hob must be deactivated. Touch  for 4 seconds until  flashes. Touch .  comes on for 4 seconds.



To deactivate the function: the hob must be deactivated. Touch  for 4 seconds until  flashes. Touch .  comes on for 4 seconds.

To override the function for only one

cooking time: activate a cooking zone.  comes on. Touch  for 4 seconds until  comes on for all zones. **Set the heat setting in 4 seconds.** You can operate the hob. When you deactivate the appliance the function operates again.

6.12 OffSound control (Deactivation and activation of the sounds)

Deactivate the hob. Touch  for 3 seconds. Touch  for 3 seconds.  or  comes on. Touch  of the timer to choose one of the following:

-  - the sounds are off
-  - the sounds are on.

To confirm your selection wait until the hob deactivates automatically.

When the function is set to  you can hear the sounds only when:

- Minute minder comes down
- Count down timer comes down
- you put something on the control panel.

6.13 Hob²Hood

It is an advanced automatic function which connects the hob to a special hood. Both the hob and the hood have an infrared signal communicator. Speed of the fan is defined

automatically on basis of mode setting and temperature of the hottest cookware on the hob. You can also operate the fan from the hob manually.



For most of the hoods the remote system is originally deactivated. Activate it before you use the function. For more information refer to hood user manual.

Operating the function automatically

To operate the function automatically set the automatic mode to H1 – H6. The hob is originally set to H5. The hood reacts whenever you operate the hob. The hob recognizes temperature of the cookware automatically and adjusts the speed of the fan.

Automatic modes

	Automat- ic light	Boiling ¹⁾	Frying ²⁾
Mode H0	Off	Off	Off
Mode H1	On	Off	Off
Mode H2 ³⁾	On	Fan speed 1	Fan speed 1
Mode H3	On	Off	Fan speed 1
Mode H4	On	Fan speed 1	Fan speed 1
Mode H5	On	Fan speed 1	Fan speed 2
Mode H6	On	Fan speed 2	Fan speed 3

1) The hob detects the boiling process and activates fan speed in accordance with automatic mode.

2) The hob detects the frying process and activates fan speed in accordance with automatic mode.

3) This mode activates the fan and the light and does not rely on the temperature.

Changing the automatic mode

1. Deactivate the appliance.
2. Press until you hear a beep and keep it pressed until you hear the second beep.
3. Press for 3 seconds until or comes on.

4. Press until H and a digit (0 - 6) comes on. H5 is the default setting.
5. Press of the Timer to select the desired mode (H0 - H6). The chosen mode activates automatically after 10 seconds.



To operate the hood directly on the hood panel deactivate the automatic mode of the function.



When you finish cooking and deactivate the hob, the hood fan may still operate for a certain period of time. After that time the system deactivates the fan automatically and prevents you from accidental activation of the fan for the next 30 seconds.

Operating the fan speed manually

You can also operate the function manually.

To do that touch when the hob is active. This deactivates automatic operation of the function and allows you to change the fan speed manually. When you press you raise the fan speed by one. When you reach an intensive level and press again you will set fan speed to 0 which deactivates the hood fan. To start the fan again with fan speed 1 touch .



To activate automatic operation of the function, deactivate the hob and activate it again.

Activating the light

You can set the hob to activate the light automatically whenever you activate the hob. To do so set the automatic mode to H1 – H6.



The light on the hood appliance deactivates 2 minutes after deactivating the hob.

6.14 Power management function

- All cooking zones are connected to one phase. See the illustration.

- The phase has a maximum electricity load.
- The function divides the power between cooking zones.
- The function activates when the total electricity load of the cooking zones is exceeded.
- The function reduces the power of the other cooking zones.
- The heat setting display of the reduced zones changes between two levels.

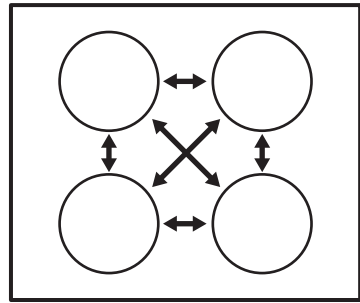

7. HOB - HINTS AND TIPS

WARNING!

Refer to Safety chapters.

7.1 Cookware



For induction cooking zones a strong electro-magnetic field creates the heat in the cookware very quickly.



Use the induction cooking zones with suitable cookware.

Cookware material

- **correct:** cast iron, steel, enamelled steel, stainless steel, multi-layer bottom (with a correct marking from a manufacturer).
- **not correct:** aluminium, copper, brass, glass, ceramic, porcelain.
- **recommended:** aluminium, copper
- **not recommended:** stainless steel, cast iron, glass

Cookware is suitable for an induction hob if:

- water boils very quickly on a zone set to the highest heat setting.
- a magnet pulls on to the bottom of the cookware.



The bottom of the cookware must be as thick and flat as possible. Ensure pan bases are clean and dry before placing on the hob surface.

Cookware dimensions

Induction cooking zones adapt to the dimension of the bottom of the cookware automatically.

The cooking zone efficiency is related to the diameter of the cookware. The cookware with a diameter smaller than the minimum receives only a part of the power generated by the cooking zone.

7.2 Minimum cookware diameter

Cooking zone	Cookware diameter (mm)	Power (W)
Left rear	125 - 140	1400/2500
Right rear	145 - 180	1800/2800
Right front	145 - 180	1800/2800
Left front	180 - 210	2300/3600

7.3 Noises during operation



The noises are normal and do not indicate any malfunction. Cookware noises may vary depending on the cookware material and the power level.

Cookware-related noises:

- cracking noise: cookware is made of different materials (a sandwich construction).
- whistling sound: you use a cooking zone with a high power level and the cookware is made of different materials (a sandwich construction).
- humming: you use a high power level.

Hob-related noises:

- clicking: electric switching occurs.
- hissing, buzzing: the fan operates.

- rhythmic sound: cookware is detected.

7.4 Öko Timer Eco timer

To save energy, the heater of the cooking zone deactivates before the count down timer sounds. The difference in the operation time depends on the heat setting level and the length of the cooking operation.

7.5 Simplified cooking guide

The correlation between the heat setting of a zone and its consumption of power is not linear. When you increase the heat setting, it is not proportional to the increase of the consumption of power. It means that a cooking zone with the medium heat setting uses less than a half of its power.



The data in the table is for guidance only.

Heat setting	Use to:	Time (min)	Hints
- 1	Keep cooked food warm.	as necessary	Put a lid on the cookware.
1 - 2.	Hollandaise sauce; melt: butter, chocolate, gelatine.	5 - 25	Mix from time to time.
2.	Solidify: fluffy omelettes, baked eggs.	10 - 40	Cook with a lid on.
2. - 3.	Simmer rice and milk-based dishes, heat up ready-cooked meals.	25 - 50	Add at least twice as much liquid as rice, mix milk dishes halfway through the procedure.
3. - 4.	Stew vegetables, fish, meat.	20 - 45	Add a few tablespoons of water. Check the water amount during the process.
4. - 5.	Steam potatoes and other vegetables.	20 - 60	Cover the bottom of the pot with 1-2 cm of water. Check the water level during the process. Keep the lid on the pot.
4. - 5.	Cook larger quantities of food, stews and soups.	60 - 150	Up to 3 l of liquid plus ingredients.
5. - 7	Gentle fry: escalope, veal cordon bleu, cutlets, rissoles, sausages, liver, roux, eggs, pancakes, doughnuts.	as necessary	Turn over when needed.
7 - 8	Heavy fry, hash browns, loin steaks, steaks.	5 - 15	Turn over when needed.
9	Boil water, cook pasta, sear meat (goulash, pot roast), deep-fry chips.		

Heat setting	Use to:	Time (min)	Hints
	Boil large quantities of water. PowerBoost is activated.		

8. HOB - CARE AND CLEANING

WARNING!

Refer to Safety chapters.

8.1 General information

- Clean the hob after each use.
- Always use cookware with a clean base.
- Scratches or dark stains on the surface have no effect on how the hob operates.
- Use a special cleaning agent suitable for the surface of the hob.
- Always use a scraper recommended for hobs with a glass surface. Use the scraper only as an additional tool for cleaning the glass after the standard cleaning procedure.

WARNING!

Do not use knives or any other sharp, metal tools to clean the glass surface.

8.2 Cleaning the hob

- **Remove immediately:** melted plastic, plastic foil, salt, sugar and food with sugar, otherwise, the dirt can cause damage to the hob. Take care to avoid burns. Use a special hob scraper on the glass surface at an acute angle and move the blade on the surface.
- **Remove when the hob is sufficiently cool:** limescale rings, water rings, fat stains, shiny metallic discoloration. Clean the hob with a moist cloth and a non-abrasive detergent. After cleaning, wipe the hob dry with a soft cloth.
- **Remove shiny metallic discoloration:** use a solution of water with vinegar and clean the glass surface with a cloth.

9. OVEN - DAILY USE

WARNING!

Refer to Safety chapters.

9.1 Top oven functions

0 Off position
The oven is off.

 **Oven lamp**
To turn on the lamp.

10 Conventional cooking
0 - To bake and roast food on one shelf position.
25
0

 **Grilling**
To grill flat food in medium quantities in the middle of the shelf. To make toasts.

 **Fast grilling**
To grill flat food and to toast bread.

9.2 Main oven functions

WARNING!

Do not pour any liquids into the cavity embossment before and during the cooking process. There is a risk of damage.

0 Off position
The oven is off.

 **Oven lamp**
To turn on the lamp.



Defrost

To defrost food. The defrosting time depends on the amount and size of the frozen food.

100 True fan cooking

- To bake on maximum two shelf positions simul-

250 taneously and to dry food.

9.3 Activating and deactivating the top / main oven



It depends on the model if your appliance has knob symbols, indicators or lamps:

- The indicator comes on when the oven heats up.
- The lamp comes on when the oven operates.
- The symbol shows whether the knob controls one of the cooking zones, the oven functions or the temperature.

1. Turn the knob for the top / main oven functions to select an oven function.
2. Turn the knob for the temperature to select a temperature.
3. To deactivate the oven turn the knob for the top / main oven functions to the off position.

9.4 Cooling fan

When the oven operates, the cooling fan turns on automatically to keep the surfaces of the oven cool. If you turn off the oven, the cooling fan continues to operate until the oven cools down.

9.5 Inserting the oven accessories

Deep pan:

Push the deep pan between the guide bars of the shelf support.

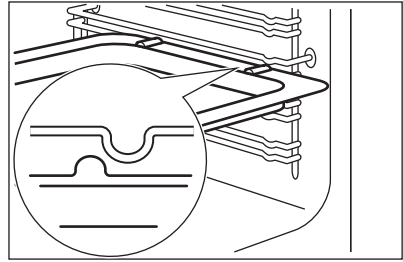

Wire shelf:

Push the shelf between the guide bars of the shelf support.

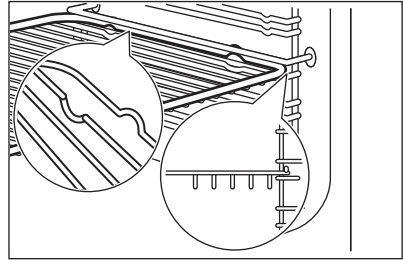

- All accessories have small indentations at the top of the right and left side to increase safety. The indentations are also anti-tip devices.
- The high rim around the shelf is a device which prevents cookware from slipping.

9.6 Trivet and Grill- / Roasting pan

You can use the trivet to roast larger pieces of meat or poultry on one shelf position.

1. Put the trivet into the deep pan. Make sure the supports of the wire shelf point up.

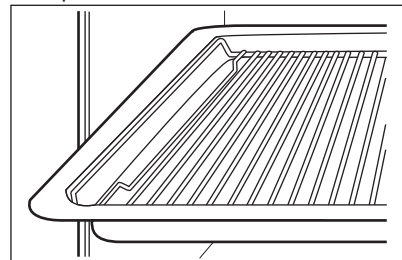

- Put the deep pan into the oven on the recommended shelf position. You can use the trivet to grill and toast thin pieces of food in large quantities.
- Put the trivet into the deep pan. Make sure the supports of the wire shelf point down.

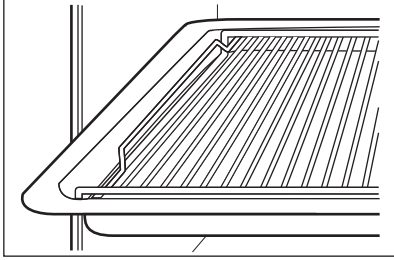

- Put the deep pan into the oven on the recommended shelf position.

10. OVEN - CLOCK FUNCTIONS

10.1 Display



The display works only with the main oven.

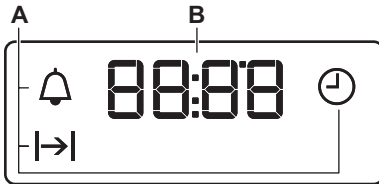



- Clock functions
- Timer





10.2 Buttons

Button	Function	Description
—	MINUS	To set the time.
🕒	CLOCK	To set a clock function.
+	PLUS	To set the time.

10.3 Clock functions

Clock function		Application
	TIME OF DAY	To set, change or check the time of day. Only the top oven works without the set time.
	DURATION	To set how long the oven works. The function works only for the main oven.
	MINUTE MINDER	To set a countdown. This function has no effect on the operation of the oven. You can set this function at any time, also when the oven is off.

10.4 Setting the DURATION

1. Set an oven function and temperature.
2. Press  again and again until  starts to flash.
3. Press  or  to set the DURATION time.



The display shows .



4. When the time ends,  flashes and an acoustic signal sounds. The appliance deactivates automatically.
5. Press any button to stop the acoustic signal.
6. Turn the knob for the oven functions and the knob for the temperature to the off position.





DURATION works only for the main oven.

10.5 Setting the MINUTE MINDER

1. Press  again and again until  starts to flash.

2. Press  or  to set the necessary time. The Minute Minder starts automatically after 5 seconds.
3. When the set time ends, an acoustic signal sounds. Press any button to stop the acoustic signal.
4. Turn the knob for the oven functions and the knob for the temperature to the off position.

10.6 Cancelling the clock functions

1. Press the  again and again until the necessary function indicator starts to flash.
 2. Press and hold .
- The clock function goes out after some seconds.

11. OVEN - HINTS AND TIPS



WARNING!

Refer to Safety chapters.



The temperature and baking times in the tables are guidelines only. They depend on the recipes and the quality and quantity of the ingredients used.

11.1 Information for test institutes

Main oven

Food	Function	Temperature (°C)	Time (min)	Accessories	Shelf position
Small cakes (20 small cakes per tray)	Conventional cooking	170	25 - 35	Tray	3
Small cakes (20 small cakes per tray)	True fan cooking	150	25 - 35	Tray	3
Small cakes (20 small cakes per tray)	True fan cooking	150	25 - 35	Tray	1 / 4
Apple pie, 2 tins (ø 20 cm) on the grid, diagonally shifted	Conventional cooking	200	80 - 100	Grid	1
Apple pie, 2 tins (ø 20 cm) on the grid, diagonally shifted	True fan cooking	170	80 - 100	Grid	2
Apple pie, 2 tins (ø 20 cm) on the grid, diagonally shifted ¹⁾	SteamBake	160	70 - 80	Tray	2
Fatless sponge cake, 1 tin (ø 26 cm) on the grid	Conventional cooking	200	25 - 35	Grid	2
Fatless sponge cake, 1 tin (ø 26 cm) on the grid	True fan cooking	170	25 - 35	Grid	2
Fatless sponge cake, 1 tin (ø 26 cm) on the grid	True fan cooking	170	30 - 40	Grid	1 / 4
Shortbread/Pastry strip	Conventional cooking	160	20 - 30	Tray	3
Shortbread/Pastry strip	True fan cooking	140	20 - 30	Tray	3
Shortbread/Pastry strip	True fan cooking	140	15 - 25	Tray	1 / 4

¹⁾ Add 150 ml of water to the cavity embossment.

Top oven

Food	Function	Temperature (°C)	Time (min)	Accessories	Shelf position
Small cakes (20 small cakes per tray)	Conventional cooking	150	25 - 35	Tray	2
Apple pie, 2 tins (ø 20 cm) on the grid, diagonally shifted	Conventional cooking	170	60 - 80	Grid	1
Fatless sponge cake, 1 tin (ø 26 cm) on the grid	Conventional cooking	170	20 - 30	Grid	2
Shortbread/Pastry strip	Conventional cooking	140	15 - 25	Tray	2
Toast	Grilling	-	3 - 8	Grid	2

Food	Function	Temperature (°C)	Time (min)	Accessories	Shelf position
Beef burger	Grilling	-	15 - 25 (first side) 10 - 20 (second side)	Grid / Roasting pan	2

12. OVEN - CARE AND CLEANING

WARNING!

Refer to Safety chapters.

12.1 Notes on cleaning

Cleaning Agents

- Clean the front of the appliance only with a microfibre cloth with warm water and a mild detergent. Clean and check the door gasket around the frame of the cavity.
- Use a cleaning solution to clean metal surfaces.
- Clean stains with a mild detergent. Do not apply it on the catalytic surfaces.

Everyday Use

- Clean the cavity after each use. Fat accumulation or other residue may cause fire.
- Do not store food in the appliance for longer than 20 minutes. Dry the cavity only with a microfibre cloth after each use.

Accessories

- Clean all accessories after each use and let them dry. Use only a microfibre cloth with warm water and a mild detergent. Do not clean the accessories in a dishwasher.
- Do not clean the non-stick accessories using abrasive cleaner or sharp-edged objects.

12.2 Catalytic cleaning

CAUTION!

Do not clean the catalytic surface with oven sprays, soap or other cleaning agents. It will damage the catalytic surface.

CAUTION!

Always turn the oven light on while using the catalytic cleaning (if applicable).

WARNING!

Keep children away when you clean the oven at a high temperature. The oven surface becomes very hot and there is a risk of burns.

i

Spots or discolouration of the catalytic surface have no effect on catalytic properties.

i

Before activating the catalytic cleaning remove all the accessories from the oven.

The walls with catalytic coating are self-cleaning. They absorb fat which collects on the walls while the appliance operates.

To support the self-cleaning procedure, heat the empty oven on a regular basis.

The oven cavities must be cleaned separately.

12.3 Cleaning the top oven

1. Clean the oven floor with warm water and washing-up liquid, then dry it.
2. Set the oven temperature to 250 °C and let the oven operate for 1 hour.
3. When the appliance is cool, clean it with a soft and moist sponge.

12.4 Cleaning the main oven

1. Clean the oven floor with warm water and washing-up liquid, then dry it.
2. Set the oven temperature to 250 °C and let the oven operate for 1 hour.
3. When the appliance is cool, clean it with a soft and moist sponge.

12.5 Removing the shelf supports

To clean the oven, remove the shelf supports.

1. Pull the front of the shelf support away from the side wall.

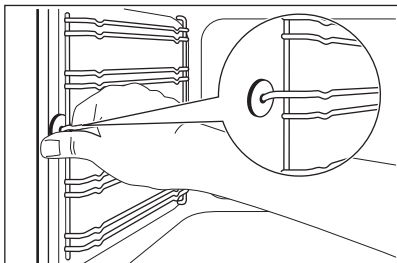

2. Pull the rear end of the shelf support away from the side wall and remove it.

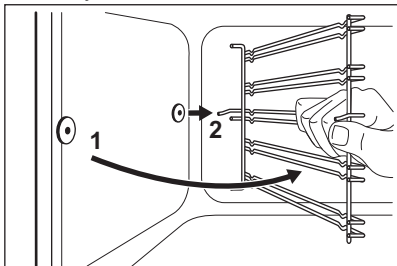

Install the shelf supports in the opposite sequence.

⚠ CAUTION!

Make sure that the longer fixing wire is in the front. The ends of the two wires must point to the rear. Incorrect installation can cause damage to the enamel.

12.6 Removing and cleaning the door glasses - top oven



The door glass in your product can be different in type and shape from the examples you see in the image. The number of glasses can also be different.

1. Open the door.
2. Hold the door trim on the top edge of the door at the two sides and push inwards to release the clip seal.

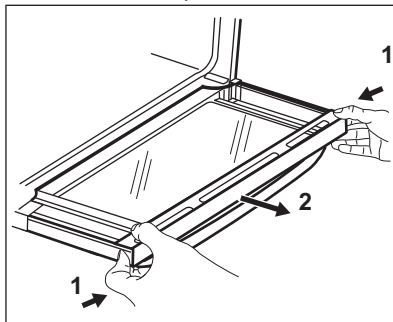

3. Pull the door trim to the front to remove it.
 4. Remove the glass panels.
- To install the panels, do the same steps in reverse.

12.7 Removing and cleaning the door glasses - main oven



The door glass in your product can be different in type and shape from the example you see in the image. The number of glasses can also be different.

1. Push the door trim at one side to remove it.

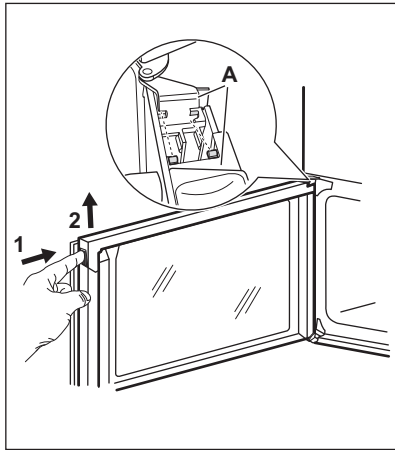

2. Pull up the trim.
3. Remove the glass panels.



To replace the glass panels, do the same steps in reverse. Before you lower the trim, attach the A trim part to the door. Refer to the image.

12.8 Replacing the lamp

WARNING!

Risk of electric shock.
The lamp can be hot.

1. Turn off the oven. Wait until the oven is cold.
2. Disconnect the oven from the mains.
3. Put a cloth on the bottom of the cavity.

The back lamp



The lamp glass cover is at the back of the cavity.

1. Turn the lamp glass cover counterclockwise to remove it.
2. Clean the glass cover.
3. Replace the oven lamp with a suitable 300 °C heat-resistant oven lamp. Use the same oven lamp type.
4. Install the glass cover.





13. TROUBLESHOOTING

WARNING!

Refer to Safety chapters.

13.1 What to do if...

Problem	Possible cause	Remedy
You cannot activate the appliance.	The appliance is not connected to an electrical supply or it is connected incorrectly.	Check if the appliance is correctly connected to the electrical supply.
You cannot activate the appliance.	The fuse is blown.	Make sure that the fuse is the cause of the malfunction. If the fuse is blown again and again, contact a qualified electrician.
You cannot activate or operate the hob.	You touched 2 or more sensor fields at the same time.	Touch only one sensor field.
You cannot activate or operate the hob.	There is water or fat stains on the control panel.	Clean the control panel.

Problem	Possible cause	Remedy
An acoustic signal sounds and the hob deactivates. An acoustic signal sounds when the hob is deactivated.	You put something on one or more sensor fields.	Remove the object from the sensor fields.
Residual heat indicator does not come on.	The zone is not hot because it operated only for a short time.	If the zone operated sufficiently long to be hot, speak to an Authorised Service Centre.
Automatic Heat Up function does not operate.	The zone is hot.	Let the zone become sufficiently cool.
Automatic Heat Up function does not operate.	The highest heat setting is set.	The highest heat setting has the same power as the function.
The heat setting changes between two levels.	Power management function operates.	Refer to "Hob - Daily use" chapter.
The sensor fields become hot.	The cookware is too large or you put it too near to the controls.	Put large cookware on the rear zones if possible.
There is no signal when you touch the panel sensor fields.	The signals are deactivated.	Activate the signals. Refer to "Hob - Daily use" chapter.
 comes on the hob display.	Automatic Switch Off operates.	Deactivate the hob and activate it again.
 comes on the hob display.	The Child Safety Device or the Lock function operates.	Refer to "Hob - Daily use" chapter.
 comes on the hob display.	There is no cookware on the zone.	Put cookware on the zone.
 comes on the hob display.	The cookware is incorrect.	Use the correct cookware. Refer to "Hob - Hints and tips" chapter.
 comes on the hob display.	The diameter of the bottom of the cookware is too small for the zone.	Use cookware with correct dimensions. Refer to "Hob - Hints and tips" chapter.
The oven does not heat up.	The oven is deactivated.	Activate the oven.
The oven does not heat up.	The clock is not set.	Set the clock.
The oven does not heat up.	The necessary settings are not set.	Make sure that the settings are correct.
The lamp does not operate.	The lamp is defective.	Replace the lamp.
The display shows "12.00".	There was a power cut.	Reset the clock.
Steam and condensation settle on the food and in the cavity of the oven.	You left the dish in the oven for too long.	Do not leave the dishes in the oven for longer than 15 - 20 minutes after the cooking process ends.

13.2 Service data

If you cannot find a solution to the problem yourself, contact your dealer or an Authorised Service Centre.

The necessary data for the service centre is on the rating plate. The rating plate is on the

front frame of the appliance cavity. Do not remove the rating plate from the appliance cavity.

We recommend that you write the data here:

Model (MOD.)

Product number (PNC)

We recommend that you write the data here:

Serial number (S.N.)

14. ENERGY EFFICIENCY

14.1 Product Information according to EU and UK Ecodesign Regulations for Hob

Model identification	CIX6540ACB CIX6540ACM CIX6540ACW	
Type of hob	Hob inside Freestanding Cooker	
Number of cooking zones	4	
Heating technology	Induction	
Diameter of circular cooking zones (Ø)	Left front	21.0 cm
	Left rear	14.0 cm
	Right front	18.0 cm
	Right rear	18.0 cm
Energy consumption per cooking zone (EC electric cooking)	Left front	178.0 Wh/kg
	Left rear	179.0 Wh/kg
	Right front	181.0 Wh/kg
	Right rear	181.0 Wh/kg
Energy consumption of the hob (EC electric hob)	179.8 Wh/kg	

IEC/EN 60350-2 - Household electric cooking appliances - Part 2: Hobs - Methods for measuring performance.

14.2 Hob - Energy saving

You can save energy during everyday cooking if you follow the hints below.

- When you heat up water, use only the amount you need.
- If it is possible, always put the lids on the cookware.

- Put the cookware directly in the centre of the cooking zone.
- Use the residual heat to keep the food warm or to melt it.

14.3 Product Information Sheet and Product Information according to EU and UK Energy Labelling and Ecodesign Regulations for Oven

Supplier's name	AEG
Model identification	CIX6540ACB 948904357 CIX6540ACM 948904358 CIX6540ACW 948904348

Energy Efficiency Index	Top oven: 105.6 Main oven: 95.4
Energy efficiency class	Top oven: A Main oven: A
Energy consumption with a standard load, conventional mode	Top oven: 0.75 Main oven: not applicable
Energy consumption with a standard load, fan-forced mode	Top oven: not applicable Main oven: 0.83 kWh/cycle
Number of cavities	2
Heat source	Electricity
Volume	Top oven: 39 l Main oven: 77 l
Type of oven	Oven inside Freestanding Cooker
Mass	CIX6540ACB 62.6 kg
	CIX6540ACM 62.4 kg
	CIX6540ACW 62.4 kg

IEC/EN 60350-1 - Household electric cooking appliances - Part 1: Ranges, ovens, steam ovens and grills - Methods for measuring performance.

14.4 Oven - Energy saving

Following tips below will help you save energy when using your appliance.

Make sure that the appliance door is closed when the appliance operates. Do not open the appliance door too often during cooking. Keep the door gasket clean and make sure it is well fixed in its position.

Use metal cookware and dark, non-reflective tins and containers to improve energy saving.

Do not preheat the appliance before cooking unless specifically recommended.

Keep breaks between baking as short as possible when you prepare a few dishes at one time.

Cooking with fan

When possible, use the cooking functions with fan to save energy.

Residual heat

When the cooking duration is longer than 30 min, reduce the appliance temperature to minimum 3 - 10 min before the end of cooking. The residual heat inside the appliance will continue to cook.

Use the residual heat to keep the food warm or warm up other dishes.



Keep food warm

Choose the lowest possible temperature setting to use residual heat and keep the food warm.

14.5 Product Information for power consumption and maximum time to reach applicable low power mode

Power consumption in standby	0.8 W
Maximum time needed for the equipment to automatically reach the applicable low power mode	20 min

15. ENVIRONMENTAL CONCERNS

Recycle materials with the symbol . Put the packaging in relevant containers to recycle it. Help protect the environment and human health by recycling waste of electrical and electronic appliances. Do not dispose of appliances marked with the symbol  with

the household waste. Return the product to your local recycling facility or contact your municipal office.

Electrolux Appliances AB - Contact Address:
Al. Powstancow Slaskich 26, 30-570 Krakow,
Poland





aeg.com

867364066-A-232024



UK
CA CE