

DAILY REFERENCE GUIDE

THANK YOU FOR PURCHASING AN HOTPOINT PRODUCT



To receive more comprehensive help and support, please register your product at www.hotpoint.eu/register





You can download the Safety Instructions and the Use and Care Guide by visiting our website docs.hotpoint.eu and following the instructions on the back of this booklet.

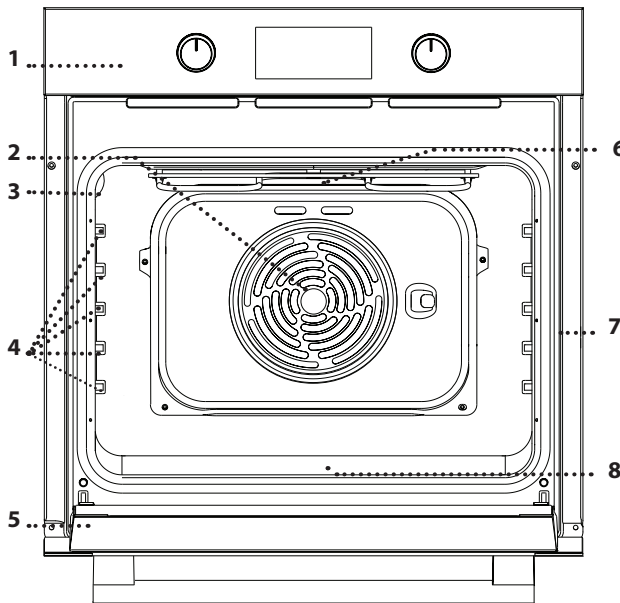

Before using the appliance carefully read the Health and Safety guide.

PRODUCT DESCRIPTION



1. Control panel
2. Fan
3. Lamp
4. Shelf guides (the level is indicated on the wall of the cooking compartment)
5. Door
6. Upper heating element/grill
7. Identification plate (do not remove)
8. steam:  embossing for drinking water

CONTROL PANEL DESCRIPTION

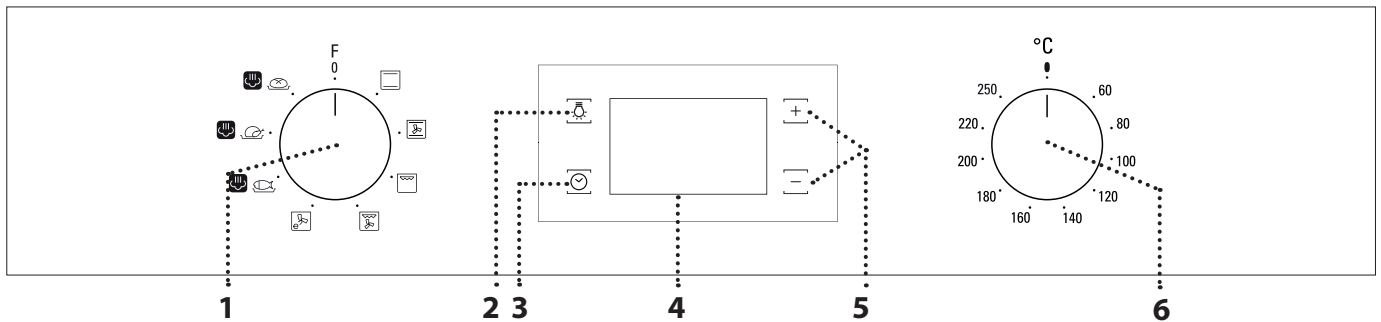

1. SELECTION KNOB

For switching the oven on by selecting a function. Turn to the 0 position to switch the oven off.

2. LIGHT

With the oven switched on, press  to turn the oven compartment lamp on or off.

3. SETTING THE TIME

For accessing the cooking time settings, delayed start and timer. For displaying the time when the oven is off.

4. DISPLAY

5. ADJUSTMENT BUTTONS

For changing the cooking time settings.

6. THERMOSTAT KNOB

Turn to select the temperature you require when activating manual functions.

Please note: the knobs are retractable. Press the knobs in the middle and they pop up."

ACCESSORIES

WIRE SHELF

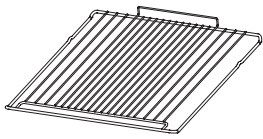

Use to cook food or as a support for pans, cake tins and other ovenproof items of cookware.

DRIP TRAY *

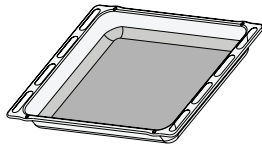

Use as an oven tray for cooking meat, fish, vegetables, focaccia, etc. or position underneath the wire shelf to collect cooking juices.

BAKING TRAY *

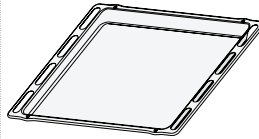

Use for cooking all bread and pastry products, but also for roasts, fish en papillote, etc.

SLIDING RUNNERS *

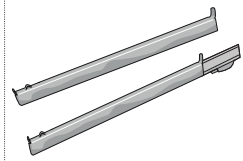

To facilitate inserting or removing accessories.

* Available only on certain models.

The number and the type of accessories may vary depending on which model is purchased.

Other accessories can be purchased separately from the After-sales Service.

INSERTING THE WIRE SHELF AND OTHER ACCESSORIES

. Insert the wire shelf onto the level you require by holding it tilted slightly upwards and resting the raised rear side (pointing upwards) down first. Then slide it horizontally along the runners as far as possible.

. Other accessories, like the baking tray, are to be inserted horizontally, letting them slide on the runners.

REMOVING AND REFITTING THE SHELF GUIDES

. To remove the shelf guides, firmly grip the external part of the guide, and pull it towards you to extract the support and the two internal pins from the lodging.

. To reposition the shelf guides, position them near the cavity and initially insert the two pins into their lodgings. Next, position the external part near its lodging, insert the support, and firmly press towards the wall of the cavity to make sure the shelf guide is properly secured.

FITTING THE SLIDING RUNNERS (IF PRESENT)

Remove the shelf guides. Disengage the guide's anchoring clips from the shelf guide, starting from the lower part.

To reinstall the sliding guides, anchor the guide's upper clip to the shelf guide, then lower the other clip into position. To secure the guide, press the lower portion of the clip firmly against the shelf guide. Make sure that the runners can move freely. Reposition the shelf guides.

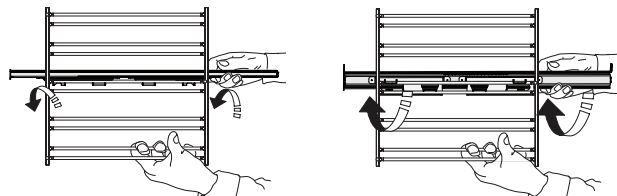



Please note: The sliding runners can be fitted on any level.



FUNCTIONS

 **CONVENTIONAL**
For cooking any kind of dish on one shelf only.

 **CONVECTION BAKE**
To cook on a maximum of two shelves at the same time. It is a good idea to swap the position of the baking trays halfway through cooking.

 **GRILL**
For grilling steaks, kebabs and sausages, cooking vegetables au gratin or toasting bread. When grilling meat, we recommend using a dripping pan to collect the cooking juices: position the pan on any of the levels below the wire shelf and add 200 ml of drinking water.

 **TURBO GRILL**
For roasting large joints of meat (legs, roast beef, chicken). We recommend using a dripping pan to collect the cooking juices: position the pan on any of the levels below the wire shelf and add 200 ml of drinking water.

 **ECO FORCED AIR**
For cooking roasts and stuffed roasting joints on a single shelf. Food is prevented from drying out excessively by gentle, intermittent air circulation. When this ECO function is in use, the light will remain switched off during cooking but can be switched on again by pressing .



steam 

- **FISH** 
- **MEAT** 
- **BREAD** 







The steam  functions provide excellent results thanks to the addition of steam in cooking cycles. Only when the oven is cold, pour drinking water on the bottom of the oven and select the specific function for your preparation. The optimal water quantities and temperatures for each food category are listed in the relative cooking table. **Preheat the oven before inserting food.**

FIRST TIME USE

1. SETTING THE TIME

You will need to set the time when you switch on the appliance for the first time: Press  until the  icon and the two digits for the hour start flashing on the display.



Use  or  to set the hour and press  to confirm. The two digits for the minutes will start flashing. Use  or  to set the minutes and press  to confirm.

Please note: When the  icon is flashing, for example following lengthy power outages, you will need to reset the time.

2. HEAT THE OVEN

A new oven may release odours that have been left behind during manufacturing: this is completely normal.

Before starting to cook food, we therefore recommend heating the oven with it empty in order to remove any possible odours.

Remove any protective cardboard or transparent film from the oven and remove any accessories from inside it.

Heat the oven to 250 °C for about one hour. The oven must be empty during this time.

Please note: It is advisable to air the room after using the appliance for the first time.

DAILY USE

1. SELECT A FUNCTION

To select a function, turn the *selection knob* to the symbol for the function you require: the display will light up and an audible signal will sound.



2. ACTIVATE A FUNCTION

MANUAL

To start the function you have selected, turn the *thermostat knob* to set the temperature you require.



Please note: During cooking you can change the function by turning the selection knob or adjust the temperature by turning the thermostat knob. The function will not start if the thermostat knob will be on . You can set the cooking time, cooking end time (only if you set a cooking time) and a timer.

steam 

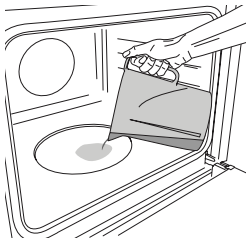

Only when the oven is cold, fill the embossing of the cavity with the quantity of drinking water suggested in the relative cooking table.

Set and activate the steam  function: At the end, carefully open the door and let steam escape slowly.

Please note: During steam cooking, do not open the door and never top up the water.

3. PREHEATING AND RESIDUAL HEAT

Once the function starts, an audible signal and a flashing icon  on the display indicate that the preheating phase is active.

When the set temperature has been reached, the icon becomes fixed and a new audible signal will sound to indicate that the food can be placed inside and cooking can proceed.

Please note: Placing food in the oven before the preheating phase has finished may have an adverse effect on the final result of cooking.



After cooking and with the function deactivated, the icon  may continue to remain visible on the display even after the cooling fan has switched off to indicate that there is residual heat in the compartment.

Please note: The time after which the icon switches off varies because it depends on a series of factors such as ambient temperature and function used. In any case, the product should be considered to be off when the pointer on the selection knob is at "0".



. PROGRAMMING COOKING

You will need to select a function before you can start programming cooking.



DURATION

Keep pressing  until the  icon and "00:00" start flashing on the display.





Use  or  to set the cooking time you require, then press  to confirm.



Activate the function by turning the *thermostat knob* to the temperature you require: an audible signal will sound and the display will indicate that cooking is complete.

Please note: To cancel the cooking time you have set, keep pressing  until the  icon starts flashing on the display, then use  to reset the cooking time to "00:00". This cooking time includes a preheating phase.

PROGRAMMING THE END COOKING TIME/ DELAYED START

After a cooking time has been set, starting the function can be delayed by programming its end time: press  until the  icon and the current time start flashing on the display.



Use  or  to set the time you want cooking to end and press  to confirm.

Activate the function by turning the *thermostat knob* to the temperature you require: the function will remain paused until it starts automatically after the period of time that has been calculated in order forcooking to finish at the time you have set.

Please note: To cancel the setting, switch the oven off by turning the selection knob to the 0 position.

END OF COOKING

An audible signal will sound and the display will indicate that the function has finished.





Turn the *selection knob* to select a different function or to 0 to switch the oven off.



Please note: If the timer is active, the display will show "END" alternately with the remaining time.

. SETTING THE TIMER

This option does not interrupt or program cooking but allows you to use the display as a timer, either during while a function is active or when the oven is off.

Keep pressing  until the  and "00:00" icon and "00:00" start flashing on the display.



















































































Use  or  to set the time you require and press  to confirm.

An audible signal will sound once the timer has finished counting down the selected time.

Notes: To cancel the timer, keep pressing  until the  icon starts flashing, then use  to reset the time to "00:00".

COOKING TABLE

RECIPE	FUNCTION	PREHEAT	TEMPERATURE (°C)	DURATION (Min)	LEVEL AND ACCESSORIES
Leavened cakes		Yes	170	30 - 50	
		Yes	160	30 - 50	
		Yes	160	40 - 60 *	 
Filled cake (cheese cake, strudel, fruit pie)		Yes	160 - 200	35 - 90	
		Yes	160 - 200	35 - 90 *	 
Biscuits / tartlets		Yes	160	25 - 35	
		Yes	160	25 - 35	
		Yes	160	20 - 35 *	 
Choux buns		Yes	180 - 200	30 - 40	
		Yes	180 - 190	35 - 45 *	 
Meringues		Yes	90	150 - 200	
		Yes	90	140 - 200	 
Pizza / Focaccia		Yes	190 - 250	15 - 50	
		Yes	190 - 250	25 - 50 *	 
Frozen pizza		Yes	250	10 - 15	
		Yes	250	10 - 20 *	 
Salty cakes (vegetable pie, quiche)		Yes	175 - 200	45 - 60	
		Yes	175 - 190	45 - 60 *	 
Vols-au-vents / puff pastry crackers		Yes	190 - 200	20 - 30	
		Yes	180 - 190	15 - 40 *	 
Lasagne / baked pasta / cannelloni / flans		Yes	190 - 200	45 - 65	
Lamb / veal / beef / pork 1 kg		Yes	190 - 200	80 - 110	
Roast pork with crackling 2 kg		Yes	180 - 190	110 - 150	
Chicken / rabbit / duck 1 kg		Yes	200 - 230	50 - 100	
Turkey / goose 3 kg		-	190 - 200	100 - 160	
Baked fish / en papillote (fillets, whole)		Yes	170 - 190	30 - 45	
Stuffed vegetables (tomatoes, courgettes, aubergines)		Yes	180 - 200	50 - 70	
Toasted bread		5'	250	2 - 6	
Fish fillets / slices		-	230 - 250	15 - 30 **	 
Sausages / kebabs / spare ribs / hamburgers		-	250	15 - 30 **	 
Roast chicken 1-1,3 kg		Yes	200 - 220	55 - 70 ***	 
Roast beef rare 1 kg		Yes	200 - 210	35 - 50 ***	
Leg of lamb / knuckle		Yes	200 - 210	60 - 90 ***	
Roast potatoes		Yes	200 - 210	35 - 55 ***	

FUNCTIONS



Conventional



Convection Bake



Grill



Turbo Grill



Eco Forced Air

ACCESSORIES



Wire shelf



Baking dish or cake tin
on the wire shelf



Baking tray/Drip tray or Baking
dish on the wire shelf



Drip tray / Baking tray



Drip tray / Baking tray with
200 ml of water

RECIPE	FUNCTION	PREHEAT	TEMPERATURE (°C)	DURATION (Min)	LEVEL AND ACCESSORIES
Vegetable gratin		-	200 - 210	25 - 55	3
Meat and potatoes		Yes	190 - 200	45 - 100 ****	4 1
Fish and vegetables		Yes	180	30 - 50 ****	4 2
Lasagne and meat		Yes	200	50 - 100 ****	4 1
Roast meat / stuffed roasting joints		-	170 - 180	100 - 150	2

* Switch racks halfway through cooking.

** Turn food halfway through cooking.

*** Turn food two thirds of the way through cooking (if necessary).

**** Estimated length of time: dishes can be removed from the oven at different times depending on personal preference. Switch racks two thirds through cooking if necessary.

steam						
RECIPE	FUNCTION	WATER (ml)	PREHEAT	TEMPERATURE (°C)	DURATION (Min)	LEVEL AND ACCESSORIES
Fish fillets / cutlets 0.5 - 2 cm	steam	250	Yes	190 - 210	10 - 20	3
Whole fish 300 - 600 g	steam	250	Yes	190 - 210	10 - 25	3
Whole fish 600 g - 1.2 kg	steam	250	Yes	180 - 200	20 - 40	3
Roast Beef rare 1 kg	steam	250	Yes	190 - 210	30 - 45	3
Lamb shank 500 g - 1.5 kg	steam	250	Yes	170 - 190	60 - 75	2
Chicken / guinea fowl / duck Whole 1 - 1.5 kg	steam	250	Yes	200 - 220	50 - 70	2
Chicken / guinea fowl / duck Pieces 500 g - 1.5 kg	steam	250	Yes	200 - 220	40 - 60	3
Chicken / turkey / duck Whole 3 kg	steam	250	Yes	160 - 180	100 - 140	2
Lamb / Beef / Pork 1 kg	steam	250	Yes	170 - 190	60 - 90	3
Small bread 80 - 100 g	steam	200	Yes	200 - 220	20 - 30	3
Sandwich loaf in tin 300 - 500 g	steam	250	Yes	170 - 190	35 - 50	3
Bread loaf 500 g - 2 kg	steam	250	Yes	160 - 170	50 - 100	2
Baguettes 200 - 300 g	steam	250	Yes	200 - 220	25 - 40	3

The time indicated does not include the preheating phase: we recommend placing the food in the oven and setting the cooking time only after the required temperature has been reached.

FUNCTIONS						steam	steam	steam
	Conventional	Convection Bake	Grill	Turbo Grill	Eco Forced Air	Fish	Meat	Bread
ACCESSORIES								
	Wire shelf	Baking dish or cake tin on the wire shelf	Baking tray/Drip tray or Baking dish on the wire shelf	Baking tray/Drip tray or Baking dish on the wire shelf	Baking tray/Drip tray or Baking dish on the wire shelf	Drip tray / Baking tray	Drip tray / Baking tray	Drip tray / Baking tray with 200 ml of water

CLEANING AND MAINTENANCE

Make sure that the oven has cooled down before carrying out any maintenance or cleaning. Do not use steam cleaners.

Do not use wire wool, abrasive scourers or abrasive/corrosive cleaning agents, as these could damage the surfaces of the appliance.

Wear protective gloves. The oven must be disconnected from the mains before carrying out any kind of maintenance work.

EXTERIOR SURFACES

Clean the surfaces with a damp microfibre cloth. If they are very dirty, add a few drops of pH-neutral detergent. Finish off with a dry cloth.

Do not use corrosive or abrasive detergents. If any of these products inadvertently comes into contact with the surfaces of the appliance, clean immediately with a damp microfibre cloth.

INTERIOR SURFACES

- After every use, leave the oven to cool and then clean it, preferably while it is still warm, to remove any deposits or stains caused by food residues. To dry any condensation that has formed as a result of cooking foods with a high water content, leave the oven to cool completely and then wipe it with a cloth or sponge.

- To remove the remaining limestone from the bottom of the cavity after the steam cooking, just pour 250 ml of white vinegar onto the embossing of the cavity (alternatively, use a specific descaling product. For availability please contact the After Sales Service). Leave it to work at room temperature for 30 minutes, then clean the cavity with warm drinking water and a soft cloth. Cleaning is recommended at least for every 5 to 10 steam cooking cycles.
- The door can be easily removed and refitted to facilitate cleaning of the glass.
- Clean the glass in the door with a suitable liquid detergent.

ACCESSORIES

Soak the accessories in a washing-up liquid solution after use, handling them with oven gloves if they are still hot. Food residues can be removed using a washing-up brush or a sponge.

REMOVING AND REFITTING THE DOOR

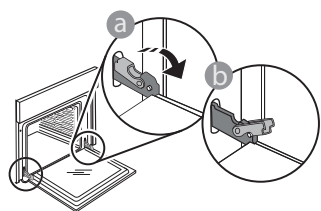

To remove the door, open it fully and lower the catches until they are in the unlock position.

3. Refit the door by moving it towards the oven, aligning the hooks of the hinges with their seating and securing the upper part onto its seating.

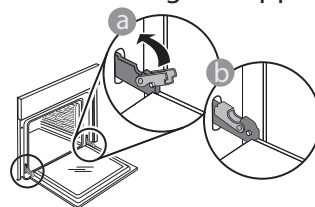

4. Lower the door and then open it fully. Lower the catches into their original position: Make sure that you lower them down completely.

Apply gentle pressure to check that the catches are in the correct position.

5. Try closing the door and check to make sure that it lines up with the control panel. If it does not, repeat the steps above: The door could become damaged if it does not work properly.

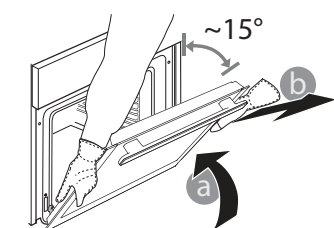

2. Close the door as much as you can. Take a firm hold of the door with both hands – do not hold it by the handle. Simply remove the door by continuing to close it while pulling it upwards at the same time

until it is released from its seating. Put the door to one side, resting it on a soft surface.

REPLACING THE LAMP

- Disconnect the oven from the power supply.
- Unscrew the cover from the light, replace the bulb and screw the cover back on the light.
- Reconnect the oven to the power supply.

Please note: Use 25 W/230 V type G9, T300 °C halogen lamps.

The bulb used in the product is specifically designed for domestic appliances and is not suitable for general room lighting within the home (EC Regulation 244/2009).

Light bulbs are available from our After-sales Service. - Do not handle bulbs with your bare hands as your fingerprints could damage them. Do not use the oven until the light cover has been refitted.

CLICK & CLEAN - CLEANING THE GLASSES

1. After removing the door and resting it on a soft surface with the handle downwards, simultaneously press the two retaining clips and remove the upper edge of the door by pulling it towards you.

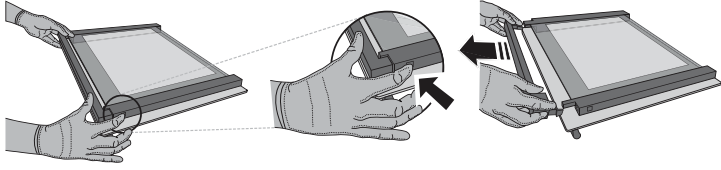

2. Lift and firmly hold the inner glass with both hands, remove it and place it on a soft surface before cleaning it.

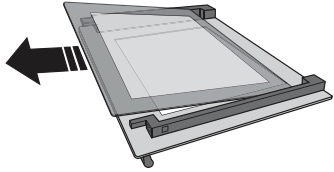

3. Refit the intermediate pane (marked with "R") before refitting the inside pane: To position the panes of glass correctly, make sure that the "R" mark can be seen in the left-hand corner. First insert the long side of the glass marked "R" into the support seats, then lower it into position. Repeat this procedure for both panes of glass.

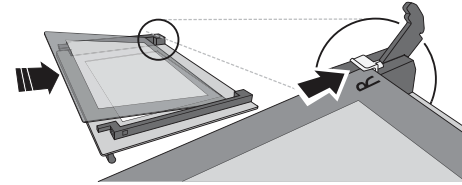

4. Refit the upper edge: A click will indicate correct positioning. Make sure the seal is secure before refitting the door.

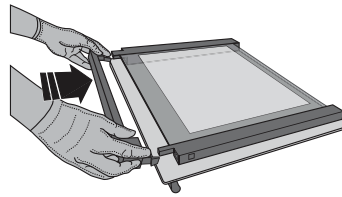

TROUBLESHOOTING

PROBLEM	POSSIBLE CAUSE	SOLUTION
The oven is not working.	Power cut. Disconnection from the mains.	Check for the presence of mains electrical power and whether the oven is connected to the electricity supply. Turn off the oven and restart it to see if the fault persists.
The display shows the letter "F" followed by a number or letter.	Oven failure.	Contact your nearest Client After-sales Service Centre and state the number following the letter "F".

PRODUCT FICHE

 [www](http://www.docs.hotpoint.eu) The product fiche with energy data of this appliance can be downloaded from the website docs.hotpoint.eu

HOW TO OBTAIN THE USE AND CARE GUIDE

>  [www](http://www.docs.hotpoint.eu) Download the Use and Care Guide from our website docs.hotpoint.eu (you can use this QR Code), specifying the product's commercial code.



> Alternatively, contact our Client After-sales Service.

CONTACTING OUR AFTER-SALES SERVICE

You can find our contact details in the warranty manual. When contacting our Client After-sales Service, please state the codes provided on your product's identification plate.

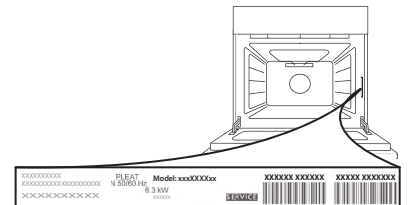

400011331884

Printed in Italy