



ID67V9KMW/UK  
ID67V9KMB/UK  
ID67V9HCCX/UK

**EN**

*ENGLISH*

Health and Safety guide

Quick guide

Installation guide

## SAFETY INSTRUCTIONS

### IMPORTANT TO BE READ AND OBSERVED

Before using the appliance, read these safety instructions. Keep them nearby for future reference.

These instructions and the appliance itself provide important safety warnings, to be observed at all times. The manufacturer declines any liability for failure to observe these safety instructions, for inappropriate use of the appliance or incorrect setting of controls.

**⚠ WARNING:** The appliance and its accessible parts become hot during use. Care should be taken to avoid touching heating elements. Children less than 8 years of age must be kept away unless continuously supervised.

**⚠ WARNING :** If the hob surface is cracked, do not use the appliance – risk of electric shock.

**⚠ WARNING :** Danger of fire : Do not store items on the cooking surfaces.

**⚠ CAUTION :** The cooking process has to be supervised. A short cooking process has to be supervised continuously.

**⚠ WARNING:** Leaving the hob unattended when cooking with fat or oil can be dangerous – risk of fire. NEVER try to extinguish a fire with water, but switch off the appliance and then cover the flames e.g. with a lid or a fire blanket.

**⚠ Do not use the hob as a work surface or support.** Keep clothes or other flammable materials away from the appliance, until all the components have cooled down completely – risk of fire.

**⚠ Very young children (0-3 years) should be kept away from the appliance. Young children (3-8 years) should be kept away from the appliance unless continuously supervised. Children from 8 years old and above and persons with reduced physical, sensory or mental capabilities or lack of experience and knowledge can use this appliance only if they are supervised or have been given instructions on safe use and understand the hazards involved. Children must not play with the appliance. Cleaning and user maintenance must not be carried out by children without supervision.**

**⚠ WARNING:** The appliance and its accessible parts become hot during use. Care should be taken to avoid touching heating elements. Children less than 8 years of age must be kept away unless continuously supervised

**⚠ Never leave the appliance unattended during food drying.** If the appliance is suitable for probe usage, only use a temperature probe recommended for this oven - risk of fire.

**⚠ Keep clothes or other flammable materials away from the appliance, until all the components have cooled down completely - risk of fire. Always**

be vigilant when cooking foods rich in fat, oil or when adding alcoholic beverages - risk of fire. Use oven gloves to remove pans and accessories. At the end of cooking, open the door with caution, allowing hot air or steam to escape gradually before accessing the cavity - risk of burns. Do not obstruct hot air vents at the front of the oven - risk of fire.

**⚠ Exercise caution when the oven door is in the open or down position, to avoid hitting the door.**

### PERMITTED USE

**⚠ CAUTION:** The appliance is not intended to be operated by means of an external switching device, such as a timer, or separate remote controlled system.

**⚠ This appliance is intended to be used in household and similar applications such as: staff kitchen areas in shops, offices and other working environments; farm houses; by clients in hotels, motels, bed & breakfast and other residential environments.**

**⚠ No other use is permitted (e.g. heating rooms).**

**⚠ This appliance is not for professional use. Do not use the appliance outdoors.**

**⚠ Do not store explosive or flammable substances (e.g. gasoline or aerosol cans) inside or near the appliance - risk of fire.**

### INSTALLATION

**⚠ The appliance must be handled and installed by two or more persons - risk of injury. Use protective gloves to unpack and install - risk of cuts.**

**⚠ Installation, including water supply (if any), electrical connections and repairs must be carried out by a qualified technician. Do not repair or replace any part of the appliance unless specifically stated in the user manual. Keep children away from the installation site. After unpacking the appliance, make sure that it has not been damaged during transport. In the event of problems, contact the dealer or your nearest Aftersales Service. Once installed, packaging waste (plastic, styrofoam parts etc.) must be stored out of reach of children - risk of suffocation. The appliance must be disconnected from the power supply before any installation operation - risk of electric shock. During installation, make sure the appliance does not damage the power cable - risk of fire or electric shock. Only activate the appliance when the installation has been completed.**

Do not remove the appliance from its polystyrene foam base until the time of installation.

**⚠ Do not install the appliance behind a decorative door - risk of fire.**

**⚠ if the range is placed on a base, it must be leveled and fixed to the wall by the retention chain provided, to prevent the appliance slipping from the base.**



**WARNING:** In order to prevent the appliance from tipping, the retention chain provided must be installed. Refer to the instructions for installation.

### **ELECTRICAL WARNINGS**

⚠ The rating plate is on the front edge of the oven (visible when the door is open).

⚠ It must be possible to disconnect the appliance from the power supply by unplugging it if plug is accessible, or by a multi-pole switch installed upstream of the socket in accordance with the wiring rules and the appliance must be earthed in conformity with national electrical safety standards.

⚠ Do not use extension leads, multiple sockets or adapters. The electrical components must not be accessible to the user after installation. Do not use the appliance when you are wet or barefoot. Do not operate this appliance if it has a damaged power cable or plug, if it is not working properly, or if it has been damaged or dropped.

⚠ If the supply cord is damaged, it must be replaced with an identical one by the manufacturer, its service agent or similarly qualified persons in order to avoid a hazard - risk of electric shock.

⚠ If the power cable needs to be replaced, contact an authorized service center.

⚠ **WARNING:** Ensure that the appliance is switched off before replacing the lamp to avoid the possibility of electric shock.

### **CLEANING AND MAINTENANCE**

⚠ **WARNING:** Ensure that the appliance is switched off and disconnected from the power supply before performing any maintenance operation; never use steam cleaning equipment - risk of electric shock.

⚠ Do not use harsh abrasive cleaners or metal scrapers to clean the door glass since they can scratch the surface, which may result in shattering of the glass.

⚠ Do not use abrasive or corrosive products, chlorine-based cleaners or pan scourers.

⚠ Make sure the appliance has cooled down before cleaning or performing maintenance. - risk of burns.

⚠ **WARNING:** Switch off the appliance before replacing the lamp - risk of electric shock.

### **DISPOSAL OF PACKAGING MATERIALS**

The packaging material is 100% recyclable and is marked with the recycle symbol . The various parts of the packaging must therefore be disposed of responsibly and in full compliance with local authority regulations governing waste disposal.

### **DISPOSAL OF HOUSEHOLD APPLIANCES**

This appliance is manufactured with recyclable or reusable materials. Dispose of it in accordance with local waste disposal regulations.



For further information on the treatment, recovery and recycling of household electrical appliances, contact your local authority, the collection service for household waste or the store where you purchased the appliance. This appliance is marked in compliance with European Directive 2012/19/EU, Waste Electrical and Electronic Equipment (WEEE) and with the Waste Electrical and Electronic Equipment regulations 2013 (as amended).

By ensuring this product is disposed of correctly, you will help prevent negative consequences for the environment and human health. The symbol  on the product or on the accompanying documentation indicates that it should not be treated as domestic waste but must be taken to an appropriate collection centre for the recycling of electrical and electronic equipment.

### **ENERGY SAVING TIPS**

Only preheat the oven if specified in the cooking table or your recipe. Use dark lacquered or enamelled baking trays as they absorb heat better.

### **DECLARATIONS OF CONFORMITY**

This appliance meets: Ecodesign requirements of European Regulation 66/2014; Energy Labelling Regulation 65/2014; Ecodesign for Energy-Related Products and Energy Information (Amendment) (EU Exit) Regulations 2019, in compliance with the European standard EN 60350-1.

This appliance meets Ecodesign requirements of European Regulation 66/2014 and The Ecodesign for Energy-Related Products and Energy Information (Amendment) (EU Exit) Regulations 2019 in compliance with the European standard EN 60350-2.

**PRODUCT DESCRIPTION**

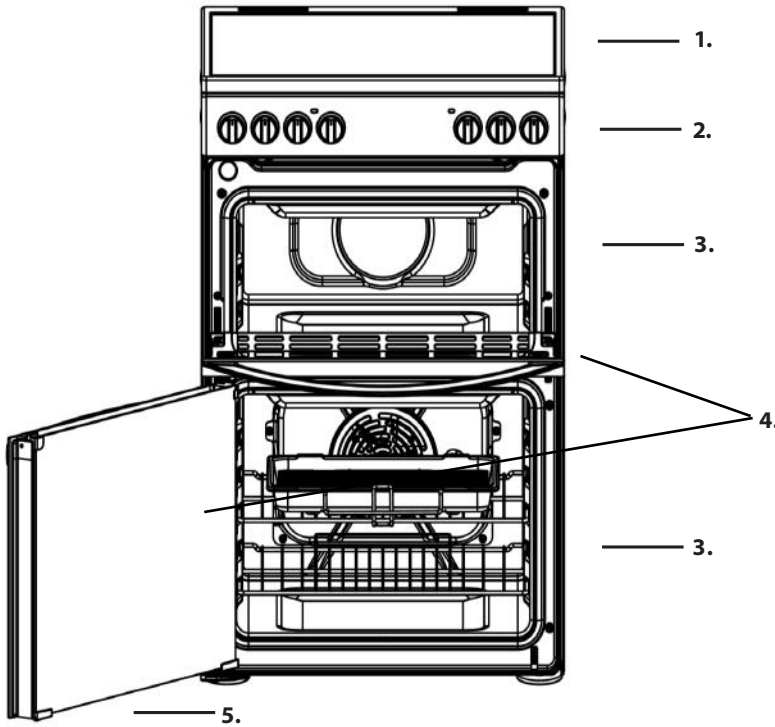

- 1. Glass ceramic hob
- 2. Control panel
- 3. Runners for accessories  
(the level is indicated on the wall of the cooking compartment)
- 4. Removable Inner Door Glass
- 5. Main oven door

**CONTROL PANEL**

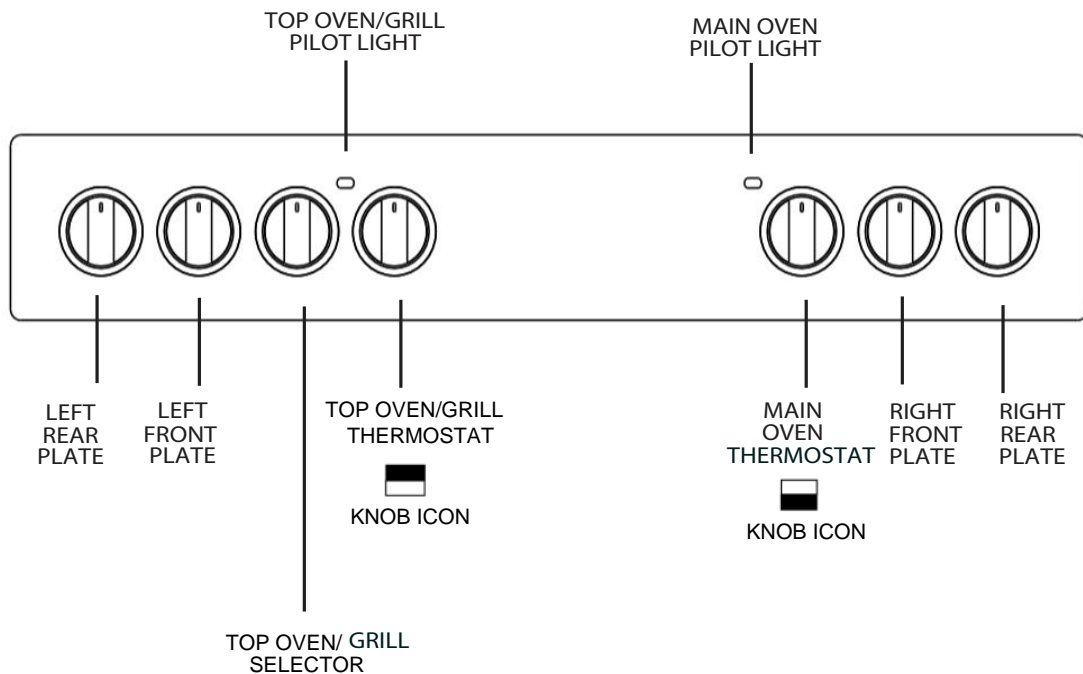

ACCESSORIES

ANTI-STICK TRAY



KIT GRILL PAN



Grill Pan Handle

The grill pan handle is detachable from the pan to facilitate cleaning and storage. Fix the pan handle securely before use:

1. Fit the handle to the grill pan so that the external 'hooks' embrace the edge of the pan (fig. 1)
2. Make sure that the middle part of the handle fits exactly the protruding support of the pan (fig. 2) and holds the pan from the bottom.

The food must be placed on the rack in the grill pan. Position the grill pan on top of the oven rack. The best results are achieved following the cooking table. Pouring a little water into the grill pan will make the collection of grease particles more efficient and prevent the formation of smoke.



GRID

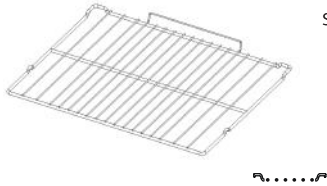

The number and type of accessories may vary depending on which model is purchased. Other accessories that are not supplied can be purchased separately from the After-sales Service.

INSTALLATION TIPS

**This appliance must be earthed. Mains Connection**

Your cooker should have been checked to ensure that the voltage corresponds with your supply voltage, this is stated on the rating plate, which is situated on the outer rear panel.

The model number and serial number are located on the front of the cooker, as shown on the Feature's page.

The cooker must be connected by a competent person such as one who is a, NICEIC registered contractor to a suitable double-pole control unit with a minimum rating of 32A and a minimum contact clearance of 3mm (applicable to newer properties, older properties where a 30A double pole control unit and a minimum contact clearance of 3mm is acceptable).

The double pole control unit should be fitted adjacent to the cooker, in accordance with IEE regulations. The control unit must be within 2 meters of but not directly above the appliance and should be easily accessible in the event of an emergency. The power supply cable should conform to B.S.6004 with a conductor size of 6mm<sup>2</sup>, minimum.

Access to the mains terminals is gained by removing the rear access cover. The mains cable must pass through the cable clamp adjacent to the terminal block. Sufficient cable should be used to allow the cooker to be pulled out for servicing.

Ensure that the mains cable is routed away from any brackets affixed to the rear panel and is not trapped to the rear wall when pushing the cooker into position between cabinets.

**This operation must be performed by a qualified technician.**

Before moving your cooker check that it is cool, and switch off at the cooker control unit. Movement of your cooker is most easily achieved by lifting the front as follows:

Open the grill door sufficiently to allow a comfortable grip on the underside front edge of the oven roof, avoiding any grill elements.

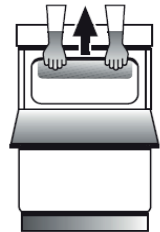

Take care in moving the cooker as it is heavy. Take care to ensure that any floor covering is not damaged.

Splashplate optional, apply to Parts Department (see Back Cover for contact number.)

The following instructions should be read by a qualified technician to ensure that the appliance is installed, regulated and technically serviced correctly in compliance with current regulations.



## FIRST TIME USE

### DAILY USE

#### MAIN OVEN

To heat the oven turn the knob clockwise, selecting the require temperature between 80°C (176°F) and 250°C (482°F) as recommended in the temperature chart. The pilot light will immediately come on and remain on until the oven reaches the required temperature. This light will then automatically go off and on during cooking as the oven thermostat maintains the correct temperature.

It should be noted that at the end of the cooking period there may be a momentary puff of steam when the oven door is opened. This will disperse in a few seconds and is a perfectly normal characteristic of an oven with a good door seal.

Since a circulaire fan oven heats up more quickly, and generally cooks food at a lower temperature than a conventional oven, pre-heating is often unnecessary. However, foods such as bread, scones, Yorkshire pudding, do benefit from being placed in a pre-heated oven.

The 'oven temperature charts' are a guide only, giving approximate cooking temperatures and times. To suit personal taste and requirements, it may be necessary to increase or decrease temperatures by 10°C.

Unless otherwise indicated in the charts food should be placed in a cold oven, i.e. without pre-heating. If food is placed in an already hot oven, the suggested cooking time should be reduced, depending on the type and quantity of food being cooked.

#### Oven positions

Since the distribution of heat in the circulaire fan oven is very even, most foods will cook satisfactorily on any shelf position, but the shelves should be evenly spaced.

The top oven rod shelf can be used in the main oven when cooking large quantities of food.

#### Food or utensils should Never be placed directly an the floor of the oven for cooking.

Never use more than 4 shelves in the oven as air circulation will be seriously restricted. To ensure oven circulation do not use meat pans larger than 390 x 300mm (15"x12") and baking trays no larger than 330 x 255mm (13"x 10"), these should be positioned centrally on the oven shelf.

Food should not be placed directly on the floor of the oven. To avoid unnecessary cleaning, rod shelves which are not in use, should be removed from the oven.

#### Temperature and time

When all four shelves are used to cook large quantities of food for home freezing or parties, it may be necessary to increase the cooking times given in the temperature charts by a few minutes, to allow for the loss of heat due to extra time taken to load the oven, and the larger mass of food. Baking trays should have an equal gap at either side of the oven.

#### TOP OVEN

The top oven should be used to cook small quantities of food. The oven is designed so that the grill element operates at a reduced heat output, this is combined with a heating element situated underneath the floor of the oven.

To ensure even cooking of the food it is important that cooking utensils are positioned correctly on the oven shelf so that the element is directly above.

There are two cooking positions, the shelf placed on runner 1 or 2 (from the base), do not use shelves upside down.

#### Food/utensils must not be placed directly on the oven floor.

There should always be at least 25mm (1in) between the top of the food and the grill element.

**Warning:** Items stored in top oven will get hot when main oven is in use.

#### Operation

While the top oven is heating up, the pilot light will come on and remain on until the oven reaches the required temperature. The pilot light will automatically go on and off during cooking as the thermostat maintains the correct temperature.

#### Do not use the grill pan as a meat pan in the top oven as air circulation will be seriously restricted.

#### Top oven as a warming compartment for plates

Place the plates/dishes on the shelf, positioned on runner 1, turn top oven control to 100°C for 10-15 minutes. Never use grill control.

When the cooker is first used an odour may be emitted, this will cease after a period of use.

When first using the cooker ensure that the room is well ventilated (e.g. open a window or use an extractor fan) and that persons who may be sensitive to the odour avoid any fumes. It is suggested that any pets be removed from the room until the smell has ceased. This odour is due to temporary finish on oven liners and elements and also any moisture absorbed by the insulation.

## USING THE GLASS CERAMIC HOB

The glue applied on the gaskets leaves traces of grease on the glass. Before using the appliance, we recommend you remove these with a special non-abrasive cleaning product. During the first few hours of use there may be a smell of rubber which will disappear very quickly.

### Switching the cooking zones on and off

To switch on a cooking zone, turn the corresponding knob in a clockwise direction.

To switch it off again, turn the knob in an anticlockwise direction until it is in the "0" position. If the ELECTRIC HOTPLATE ON indicator light is lit, this shows that at least one hotplate on the hob is switched on.

### Cooking zones

The hob is equipped with electric radiant heating elements. When they are in use the following items on the hob become red.

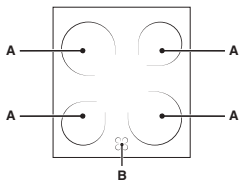

A. The cooking zone.  
B. The residual heat indicator light: this indicates that the temperature of the corresponding cooking zone is greater than 60°C, even when the heating element has been switched off but is still hot.

### Cooking zones with radiant heating elements

They have similar properties to gas burners: they are easy to control and reach set temperatures quickly, allowing you to actually see the power they are providing.

Turn the corresponding knob in a clockwise direction, to a position between 1 and 6.

Setting	Normal or Fast Plate
0	Off
1	Cooking vegetables, fish
2	Cooking potatoes (using steam) soups, chickpeas, beans.
3	Continuing the cooking of large quantities of food, minestrone
4	For roasting (average)
5	For roasting (above average)
6	For browning and reaching a boil in a short time.

### PRACTICAL ADVICE ON USING THE HOB

- Use pans with a thick, flat base to ensure that they adhere perfectly to the cooking zone.

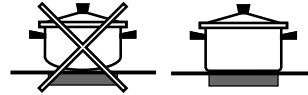

- Always use pans with a diameter that is large enough to cover the hotplate fully, in order to use all the heat produced.

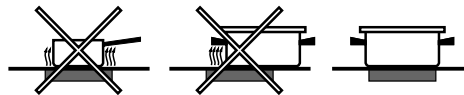

- Always make sure that the base of the pan is completely clean and dry: this ensures that the pans adhere perfectly to the cooking zones and that both the pans and the hob last for a longer period of time.
- Avoid using the same cookware that is used on gas burners: the heat concentration on gas burners may have warped the base of the pan, causing it not to adhere to the surface correctly.
- Never leave a cooking zone switched on without a pan on top of it, as doing so may cause the zone to become damaged.

Ratings of Cooking Zones			
Front Left	Front Right	Back Left	Back Right
Ceramic 1800 W 180 mm diameter	Ceramic 1200 W 140mm diameter	Ceramic 1200 W 140mm diameter	Ceramic 1800 W 180 mm diameter



## FUNCTIONS & DAILY USE

### 1. SELECT A FUNCTION

#### TOP OVEN

To select a function, turn the Top Oven/Grill Selection Knob to the symbol for the function you require, then select the required temperature by turning the Top Oven/Grill Temperature Knob.



#### CONVENTIONAL

For cooking any kind of dish on one shelf only.



#### BOTTOM

This function can be used to finish cooking filled pies or to thicken soups. Use this function for the last 10/15 minutes of cooking.



#### LEFT GRILL

For grilling small food like bacon or toasting bread. The grill pan is placed on top of the top oven cavity shelf. The shelf position can be adjusted to allow for grilling different types of food.



#### GRILL

For grilling steaks, kebabs and sausages, cooking vegetables au gratin or toasting bread. When grilling meat, we recommend using a drip tray to collect the cooking juices: Position the pan on any of the levels below the wire shelf and add 200 ml of drinking water.

#### MAIN OVEN - FAN COOKING

This control switches on the main oven. To select Fan Cooking - Turn the control clockwise and select any temperature between 90°C and Max. As the control is turned the fan will start. The main oven light will immediately come on.

The thermostat light indicates that the main oven is heating. When it turns off, the temperature inside the oven has reached the setting made with the main oven knob. At this point, the light will turn on and off as the oven maintains the temperature at a constant level.

The fan and the oven interior light will remain on throughout cooking. The red main oven thermostat light will come on until the oven reaches the required temperature. It will then cycle off and on as the oven thermostat maintains the correct temperature.

The heat for fan cooking in the main oven is provided by an element situated at the back of the oven, around the fan.

Fan cooking is ideal for large poultry or joints of meat, reducing cooking times and often eliminating the need for pre-heating the oven. It is also ideal for batch cooking where food is cooked on more than one level, because the forced circulation of hot air gives an even temperature from the top to the bottom of the oven.











































#### FORCED AIR













For cooking different foods on multiple shelves (maximum of four) at the same time. This function can be used to cook different foods without odours being transferred from one food to another.

## COOKING TABLE

## MAIN OVEN



























RECIPE	FUNCTION	PREHEAT	TEMPERATURE (°C)	DURATION (Min)	LEVEL (L-number) AND ACCESSORIES
Leavened cakes / Sponge cakes	FORCED AIR	YES	160-170	30-50	2  
Leavened cakes / Sponge cakes	FORCED AIR	YES	160-170	30-50	2/4  
Filled cake (cheese cake, strudel, fruit pie)	FORCED AIR	YES	160-180	50-70	2 
Filled cake (cheese cake, strudel, fruit pie)	FORCED AIR	YES	150-170	40-70	2/4  
Cookies / Shortbread	FORCED AIR	YES	140-150	40-50	3 
Cookies / Shortbread	FORCED AIR	YES	140-150	40-60	2/4 
Cookies / Shortbread	FORCED AIR	YES	140-150	35-50	2/4/5 
Small cakes / Muffin	FORCED AIR	YES	160-170	30-50	3 
Small cakes / Muffin	FORCED AIR	YES	150-160	30-50	2/5 
Small cakes / Muffin	FORCED AIR	YES	150-160	40-60	1/3/5 
Choux buns	FORCED AIR	YES	170-200	30-60	3 
Choux buns	FORCED AIR	YES	170-200	20-50	4  2  
Choux buns	FORCED AIR	YES	170-200	20-50	1/3/5 
Meringues	FORCED AIR	YES	80-100	120-200	3 
Meringues	FORCED AIR	YES	80-100	120-200	4  2  
Meringues	FORCED AIR	YES	80-100	120-200	5  1/3  
Pizza / Bread / Focaccia	FORCED AIR	YES	190-250	15-50	2 
Pizza / Bread / Focaccia	FORCED AIR	YES	190-230	20-50	2/4 
Pizza / Bread / Focaccia	FORCED AIR	YES	190-230	20-50	2/4/5 
Savoury pies (vegetable pie, quiche)	FORCED AIR	YES	180	30-60	3  
Vols-au-vent / Puff pastry crackers	FORCED AIR	YES	180-210	15-40	3 
Vols-au-vent / Puff pastry crackers	FORCED AIR	YES	180-210	15-40	4  2  
Lasagne / Flans / Baked pasta / Cannelloni	FORCED AIR	YES	180-200	40-75	3  
Lamb / Veal / Beef / Pork 1 kg	FORCED AIR	YES	190-200	80-110	3  
Chicken / Rabbit / Duck 1 kg	FORCED AIR	YES	200-230	50-100	3  





## COOKING TABLE

Fish fillets / Steaks	FORCED AIR	YES	180-200	20-30	3  
Roast potatoes	FORCED AIR	YES	190-220	40-80	3  
Vegetable gratin	FORCED AIR	YES	180-200	20-30	3  
Stuffed vegetables (tomatoes, courgettes, aubergines)	FORCED AIR	YES	190-220	40-80	3  
Complete meal: (Cook3) Fruit tart Lasagna Roast	FORCED AIR	-	180-190	40-100	1  3/5 
Complete meal (Cook4) Fruit tart Lasagna Cuts of meat Roasted vegetables	FORCED AIR	-	180-190	40-80	1/2  3/5 

## COOKING TABLE

## TOP OVEN

RECIPE	FUNCTION	PREHEAT	TEMPERATURE (°C)	DURATION (MIN)	LEVEL (L –number and accessories)
Leavened cakes / Sponge cakes	CONVENTIONAL	YES	170	20-50	1  
Filled cake (cheese cake, strudel, fruit pie)	CONVENTIONAL	YES	160-180	40-60	2 
Cookies / Shortbread	CONVENTIONAL	YES	140-150	20-50	2 
Small cakes / Muffin	CONVENTIONAL	YES	160-170	20-50	2 
Choux buns	CONVENTIONAL	YES	170-200	20-50	2 
Meringues	CONVENTIONAL	YES	80-100	120-200	2 
Pizza / Bread / Focaccia	CONVENTIONAL	YES	190-250	15-50	2 
Vols-au-vent / Puff pastry crackers	CONVENTIONAL	YES	180-210	15-40	2 
Lasagne / Flans / Baked pasta / Cannelloni	CONVENTIONAL	YES	180-200	30-65	2  
Lamb / Veal / Beef / Pork 1 kg	CONVENTIONAL	YES	190-200	20-50	2  
Chicken / Rabbit / Duck 1 kg	CONVENTIONAL	YES	200-230	50-100	2  
Fish fillets / Steaks	GRILL	-	230 - MAX	15 - 35	2 
Stuffed vegetables (tomatoes, courgettes, aubergines)	CONVENTIONAL	YES	190-220	40 - 80	2  
Vegetable gratin	GRILL	-	230-MAX	10-30	2  
Toast	GRILL	5'	MAX	0.5-1.5	2 
Sausages / Kebabs / Spare ribs / Hamburgers	GRILL	-	230 - MAX	15-30	2 
Roast potatoes	CONVENTIONAL	YES	190-220	40-80	2  
Leg of lamb/Shanks	CONVENTIONAL	YES	200-230	50-100	2  

ACCESSORIES					
	Wire shelf	Baking dish or cake tin on the wire shelf	Baking tray/Drip tray or Baking dish on the wire shelf	Drip tray / Baking tray	Drip tray / Baking tray with 500 ml of water

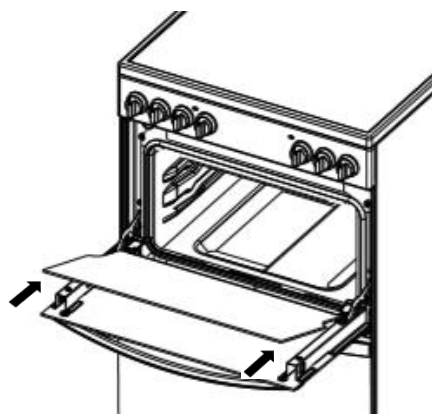
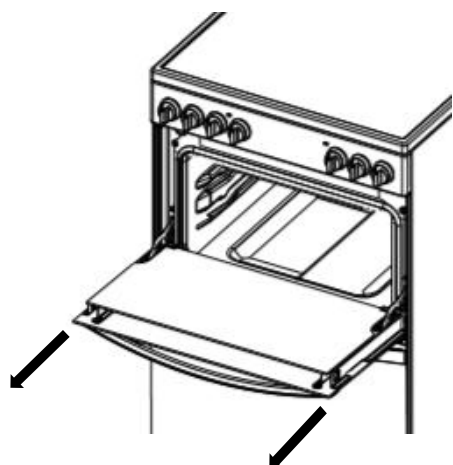
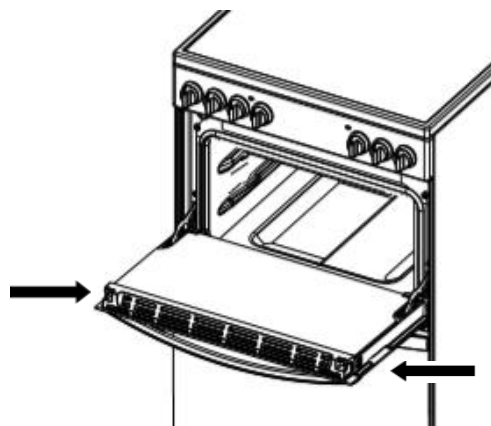

### Cleaning the glass door with 2 panels

#### TOP OVEN DOORS

1.

Open the door to 30°. Removing the retaining bar depress carefully the clips on both sides of the bar. Pull the trim up gently until the retainer is released.

2.

Carefully slide the first inner glass towards you, taking care not to allow the glass to fall.

3.

Now the external glass panel can be washed.

**Ensure the glass panel is not subjected to any sharp mechanical blows.** Take particular care not to damage the inner surface which is coated with a heat reflective layer. After cleaning, rinse and dry with a soft cloth. For slight soiling the inner glass panel may be cleaned, while still warm, without removing it from the door.

**Oven must not be operated with inner door glass removed.**

4.

To reassemble the oven doors proceed with inserting the glass panels in the reverse order, pushing gently every panel directly into the liners, so that the warning sign printed on the glass is correctly legible.

**CLEANING AND MAINTENANCE**

**TURN OFF THE MAIN SWITCH AND ENSURE THE COOKER IS COLD BEFORE CLEANING. BEFORE SWITCHING ON AGAIN, ENSURE THAT ALL CONTROLS ARE IN THE OFF POSITION.**

**Do not use steam cleaning equipment.**

**Use protective gloves during all operations.**

**Carry out the required operations when the oven is cold.**

**Disconnect the appliance from the power supply.**

**Do not use wire wool, abrasive scourers or abrasive/corrosive cleaning agents, as these could damage the surfaces of the appliance.**

Disconnect the appliance from the power supply.

**CLEANING THE CERAMIC HOB**

Although ceramic glass is hard wearing and can be kept looking attractive for many years, some marks may not be easily removed from the glass by simply wiping with a damp cloth. For everyday marks, regular use of a ceramic hob cleaner is recommended for care and protection of the hob glass surface. It contains a mild cleaning agent so that subsequent applications may clean and apply a protective film at the same time. Stubborn stains or burnt-on residue from spillage on the glass surface, can be removed using a safety scraper in addition to the ceramic hob cleaner.

While there are many brands available through major retailers, we recommend WPRO cleaning products for our domestic appliance range. To order a WPRO cleaning kit including Cream Cleaner and Safety Scraper, call us on 03448 224224 and choose the option to purchase parts. Please quote part number 484000008418 to help identify exactly the kit required.

**CLEANING THE OVEN SURFACE**

**EXTERIOR SURFACES**

- Clean the surfaces with a damp microfibre cloth. If they are very dirty, add a few drops of pH-neutral detergent. Dry them with a dry cloth.
- Do not use corrosive or abrasive detergents. If any of these products inadvertently comes into contact with the surfaces of the appliance, clean immediately with a damp microfibre cloth.

**INTERIOR SURFACES**

- After every use, leave the oven to cool and then clean it, preferably while it is still warm, to remove any deposits or stains caused by food residues. To dry any condensation that has formed as a result of cooking foods with a high water content, let the oven to cool completely and then wipe it with a cloth or sponge.
- Clean the glass in the door with a suitable liquid detergent.

**ACCESSORIES**

Soak the accessories in a washing-up liquid solution after use, handling them with oven gloves if they are still hot. Food residues can be removed using a washing-up brush or a sponge.

**REPLACING THE LIGHT**

1. Disconnect the oven from the power supply.
2. Unscrew the cover from the light, replace the bulb and screw the cover back on the light.

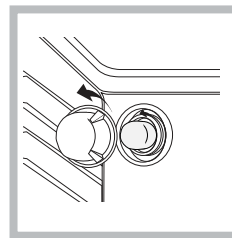

3. Reconnect the oven to the power supply.  
Note: Use 40 W/230 V type G9

The bulb used in the product is specifically designed for domestic appliances and is not suitable for general room lighting within the home (EC Regulation 244/2009). Light bulbs are available from our After-sales Service. - Do not handle bulbs with your bare hands as your fingerprints could damage them. Do not use the oven until the light cover has been refitted.

This product contains a light source of energy efficiency class G

**Steam & Clean ( Top oven only )**

The action of the steam released during this special low-temperature cleaning cycle allows dirt and food residues to be removed with ease. Pour 200 ml of drinking water on the bottom of the oven and set the temperature at 90°C for 20'. Activate the function "CONVENTIONAL" after 20' switch off the oven and let it cool down for 15'.

**LOWER THE TOP HEATING ELEMENT**

The top heating element of the grill can be lowered to clean the upper panel of the oven: Extract the heating element from its seating, then lower it. To return the heating element to its position, lift it up, pull it slightly towards you and make sure that the tab support is in its proper seating.



**TROUBLESHOOTING**

What to do if...	Possible reasons	Solutions
The oven is not working.	Power cut. Disconnection from the mains.	Check for the presence of mains electrical power and whether the oven is connected to the electricity supply. Turn off the oven and restart it to see if the fault persists.

**USEFUL TIPS**

**HOW TO READ THE COOKING TABLE**

The table lists the best function, accessories and level to use to cook various different types of food. Cooking times start from the moment food is placed in the oven, excluding preheating (where required). Cooking temperatures and times are approximate and depend on the amount of food and the type of accessory used. Use the lowest recommended settings to begin with and, if the food is not cooked enough, then switch to higher settings. Use the accessories supplied and preferably dark-coloured metal cake tins and baking trays. You can also use Pyrex or stoneware pans and accessories, but bear in mind that cooking times will be slightly longer.

It should be noted that at the end of the cooking period there may be a momentary puff of steam when the oven door is opened. This will disperse in a few seconds and is a perfectly normal characteristic of an oven with a good door seal.

**AFTER-SALES SERVICE**

To receive assistance, call the number given on the warranty leaflet enclosed with the product or follow the instructions on our website. Be prepared to provide:

- a brief description of the problem;
- the exact model type of your product;
- the assistance code (the number following the word SERVICE on the identification plate attached to the product, which can be seen on the inside edge when the oven door is open);
- your full address;
- a contact telephone number.

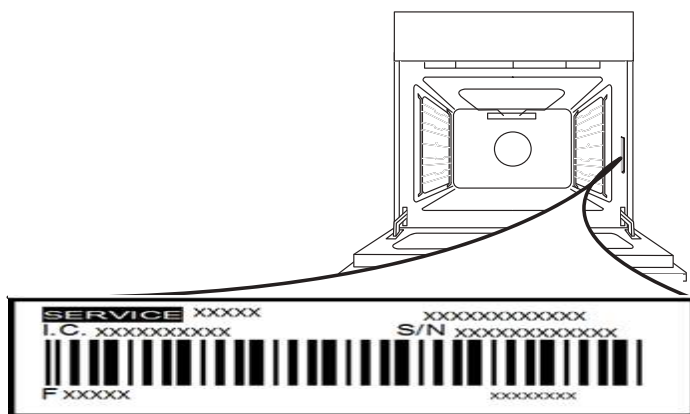

Please note: If repairs are required, contact an authorised service centre that is guaranteed to use original spare parts and perform repairs correctly.

Please refer to the enclosed warranty leaflet for more information on the warranty.

 A complete product specification, including the energy efficiency ratings for this oven, can be read and downloaded from our website [www.indesit.com](http://www.indesit.com)

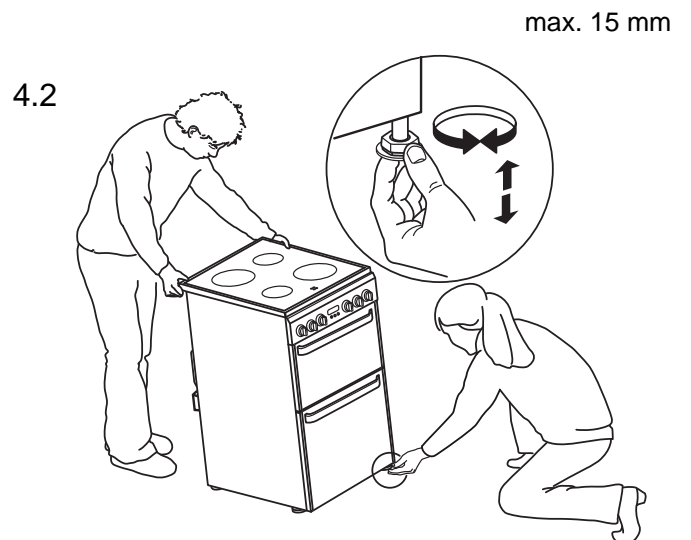
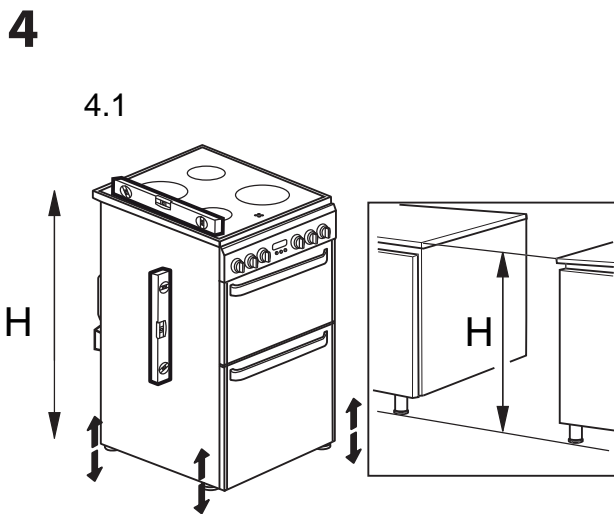
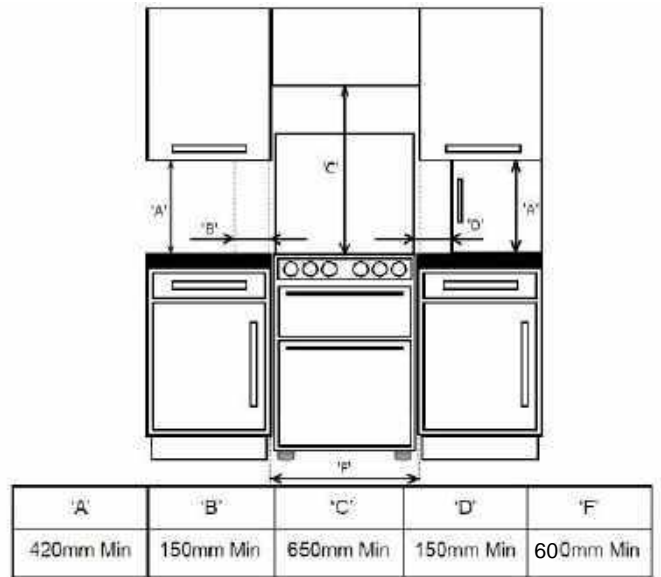
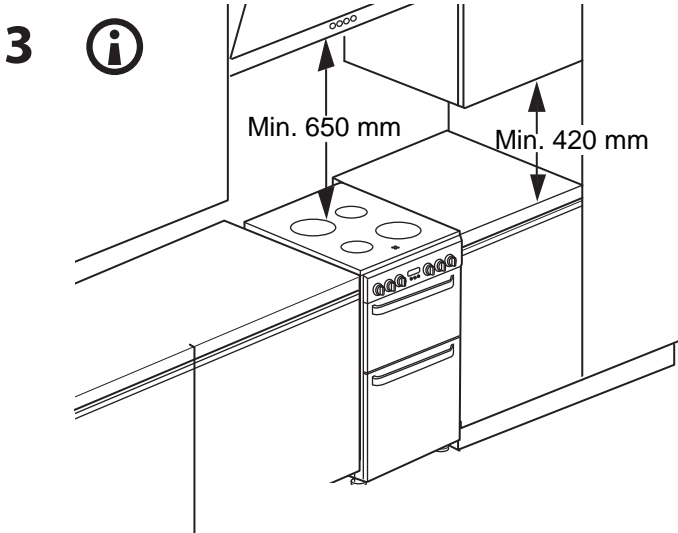
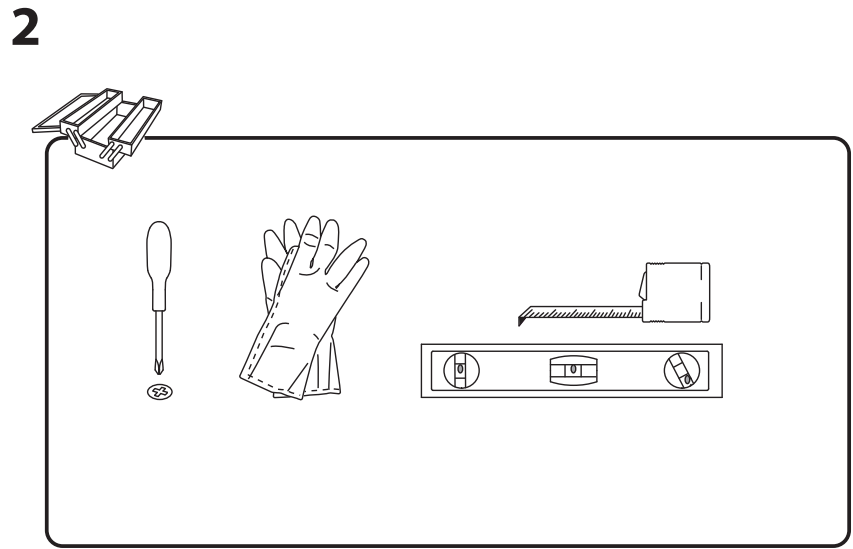
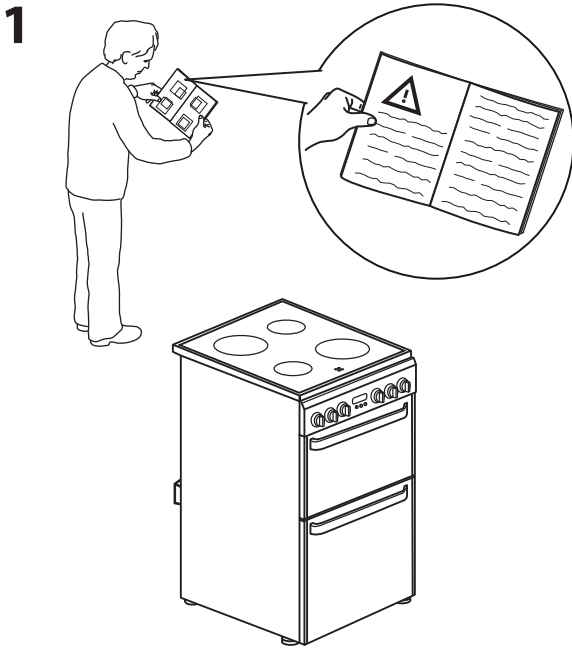

# 5

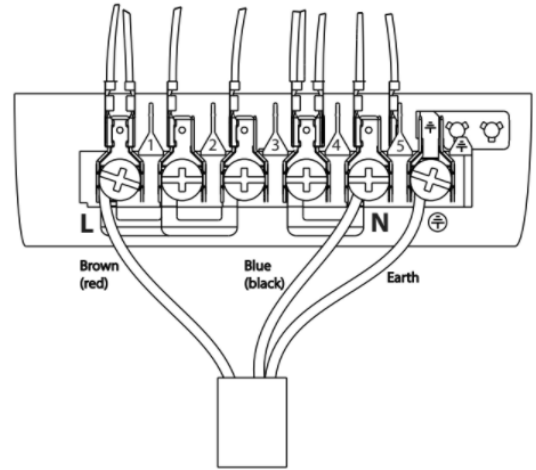
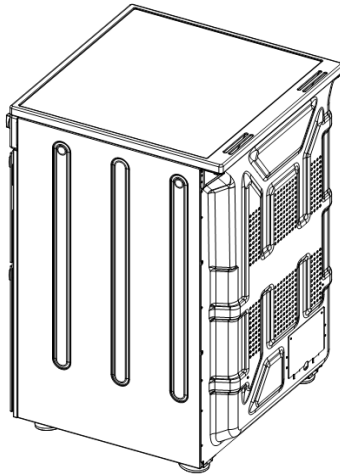

# 6



Disassemble cover.

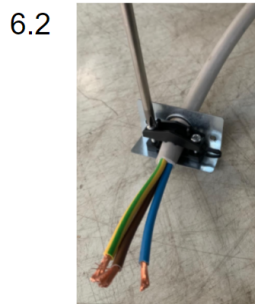

Fix power cord to the plastic holder.

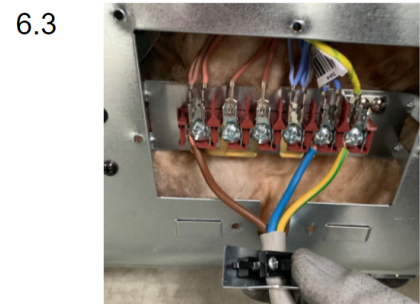

Fix wires to terminal block sockets. To avoid any loose connections, ensure all screws are fully tightened and the 3 copper terminal links are in position as shown.

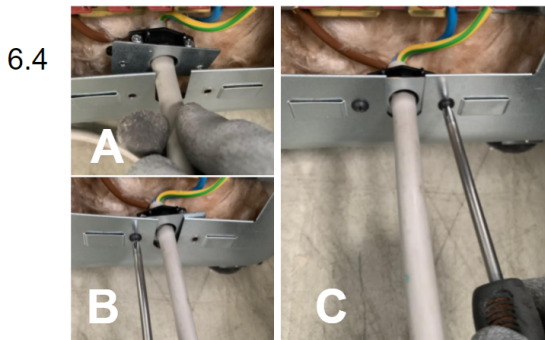

Fix metal bracket to the rear panel of cooker.



Assemble cover and tighten screws.

# 7

