



GA5PB501AB
GA5PB50FAB

EN User Manual | **Oven**



INSTALLATION

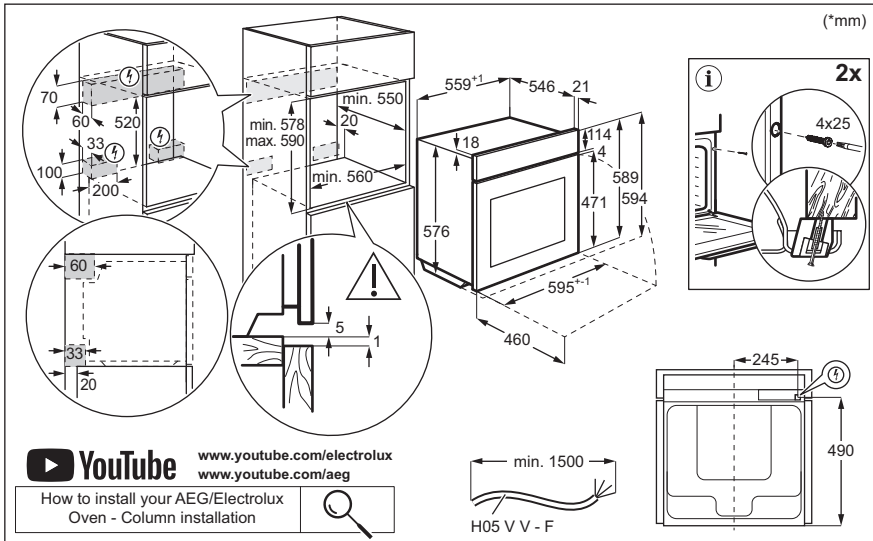

Welcome to AEG! Thank you for choosing our appliance.



Get usage advice, brochures, troubleshooting, service and repair information:
www.aeg.com/support

Subject to change without notice.

CONTENTS

1. SAFETY INFORMATION.....	3
2. SAFETY INSTRUCTIONS.....	5
3. PRODUCT DESCRIPTION.....	8
4. CONTROL PANEL.....	8
5. BEFORE FIRST USE.....	9
6. DAILY USE.....	10
7. ADDITIONAL FUNCTIONS.....	14
8. CLOCK FUNCTIONS.....	15
9. USING THE ACCESSORIES.....	16
10. HINTS AND TIPS.....	18
11. CARE AND CLEANING.....	19
12. TROUBLESHOOTING.....	22
13. ENERGY EFFICIENCY.....	23
14. ENVIRONMENTAL CONCERNS.....	24

1. ⚠ SAFETY INFORMATION

Before the installation and use of the appliance, carefully read the supplied instructions. The manufacturer is not responsible for any injuries or damage that are the result of incorrect installation or usage. Always keep the instructions in a safe and accessible location for future reference.

1.1 Children and vulnerable people safety

- This appliance can be used by children aged from 8 years and above and persons with reduced physical, sensory or mental capabilities or lack of experience and knowledge if they have been given supervision or instruction concerning the use of the appliance in a safe way and understand the hazards involved. Children of less than 8 years of age and persons with very extensive and complex disabilities shall be kept away from the appliance unless continuously supervised.

- Children should be supervised to ensure that they do not play with the appliance and mobile devices with the app.
- Keep all packaging away from children and dispose of it appropriately.
- **WARNING:** The appliance and its accessible parts become hot during use. Keep children and pets away from the appliance when in use and when cooling down.
- If the appliance has a child safety device, it should be activated.
- Children shall not carry out cleaning and user maintenance of the appliance without supervision.

1.2 General Safety

- This appliance is for cooking purposes only.
- This appliance is designed for single household domestic use in an indoor environment.
- This appliance may be used in offices, hotel guest rooms, bed & breakfast guest rooms, farm guest houses and other similar accommodation where such use does not exceed (average) domestic usage levels.
- Only a qualified person must install this appliance and replace the cable.
- Do not use the appliance before installing it in the built-in structure.
- Disconnect the appliance from the power supply before carrying out any maintenance.
- If the supply cord is damaged, it must be replaced by the manufacturer, its Authorised Service Centre or similarly qualified persons to avoid an electrical hazard.
- The means for disconnection must be incorporated in the fixed wiring in accordance with the wiring rules.
- **WARNING:** Ensure that the appliance is switched off before replacing the lamp to avoid the possibility of electric shock.
- **WARNING:** The appliance and its accessible parts become hot during use. Care should be taken to avoid touching heating elements or the surface of the appliance cavity.

- Always use oven gloves to remove or insert accessories or ovenware.
- Use only the food sensor (core temperature sensor) recommended for this appliance.
- To remove the shelf supports first pull the front of the shelf support and then the rear end away from the side walls. Install the shelf supports in the opposite sequence.
- Do not use a steam cleaner to clean the appliance.
- Do not use harsh abrasive cleaners or sharp metal scrapers to clean the glass door since they can scratch the surface, which may result in shattering of the glass.
- Before pyrolytic cleaning, remove all accessories and excessive deposits/spills from the appliance cavity.

2. SAFETY INSTRUCTIONS

2.1 Installation

WARNING!

Only a qualified person must install this appliance.

- Remove all the packaging.
- Do not install or use a damaged appliance.
- Follow the installation instructions available on our website.
- Always take care when moving the appliance as it is heavy. Always use safety gloves and enclosed footwear.
- Do not pull the appliance by the handle.
- Install the appliance in a safe and suitable place that meets installation requirements.
- Keep the minimum distance from other appliances and units.
- Before mounting the appliance, check if the appliance door opens without restraint.
- The appliance is equipped with an electric cooling system. It must be operated with the electric power supply.

2.2 Electrical connection

WARNING!

Risk of fire and electric shock.

- All electrical connections should be made by a qualified electrician.
- The appliance must be earthed.
- Make sure that the parameters on the rating plate are compatible with the electrical ratings of the mains power supply.
- Always use a correctly installed shockproof socket.
- Do not use multi-plug adapters and extension cables.
- Make sure not to cause damage to the mains plug and to the mains cable. Should the mains cable need to be replaced, this must be carried out by our Authorised Service Centre.
- Do not let mains cables touch or come near the appliance door or the niche below the appliance, especially when it operates or the door is hot.
- The shock protection of live and insulated parts must be fastened in such a way that it cannot be removed without tools.
- Connect the mains plug to the mains socket only at the end of the installation. Make sure that there is access to the mains plug after the installation.
- If the mains socket is loose, do not connect the mains plug.
- Do not pull the mains cable to disconnect the appliance. Always pull the mains plug.

- Use only correct isolation devices: line protecting cut-outs, fuses (screw type fuses removed from the holder), earth leakage trips and contactors.
- The electrical installation must have an isolation device which lets you disconnect the appliance from the mains at all poles. The isolation device must have a contact opening width of minimum 3 mm.
- Fully close the appliance door before you connect the mains plug to the mains socket.
- This appliance is supplied without a main plug and a main cable.

2.3 Use

WARNING!

Risk of injury, burns and electric shock or explosion.

- Do not change the specification of this appliance.
- Make sure that the ventilation openings are not blocked.
- Do not let the appliance stay unattended during operation.
- Deactivate the appliance after each use.
- Be careful when you open the appliance door while the appliance is in operation. Hot air can be released.
- Do not operate the appliance with wet hands or when it comes in contact with water.
- Do not apply pressure on the open door.
- Do not use the appliance as a work surface or as a storage surface.
- Open the appliance door carefully. The use of ingredients with alcohol can cause a mixture of alcohol and air.
- Do not let sparks or open flames to come in contact with the appliance when you open the door.
- Always use glass and jars approved for preserving purposes.
- Do not put flammable products or items moistened with flammable products in, near or on the appliance.
- Do not share your Wi-Fi password.

WARNING!

Risk of damage to the appliance.

- To prevent damage or discolouration to the enamel:
 - do not put ovenware or other objects directly on the bottom of the appliance's cavity.
 - do not put aluminium foil directly on the bottom of cavity of the appliance.
 - do not put water directly into the hot appliance.
 - do not keep moist dishes and food in the appliance after you finish the cooking.
 - be careful when you remove or install the accessories.
- Discolouration of the enamel or stainless steel has no effect on the performance of the appliance.
- Use a deep pan for moist cakes. Fruit juices cause stains that can be permanent.
- Use only accessories supplied with this appliance or recommended by the manufacturer.
- Always cook with the appliance door closed.
- If the appliance is installed behind a furniture panel (e.g. a door) make sure the door is never closed when the appliance operates. Heat and moisture can build up behind a closed furniture panel and cause subsequent damage to the appliance, the housing unit or the floor. Do not close the furniture panel until the appliance has cooled down completely after use.

2.4 Care and cleaning

WARNING!

Risk of injury, fire, or damage to the appliance.

- Before maintenance, deactivate the appliance and disconnect the mains plug from the mains socket.
- Make sure the appliance is cold. There is the risk that the glass panels can break.
- Replace immediately the door glass panels when they are damaged. Contact the Authorised Service Centre.
- Be careful when you remove the door from the appliance, the door is heavy.
- Clean regularly the appliance to prevent the deterioration of the surface material.

- Clean the appliance with a moist soft cloth. Use only neutral detergents. Do not use abrasive products, abrasive cleaning pads, solvents or metal objects.
- If you use an oven spray, follow the safety instructions on its packaging.

2.5 Pyrolytic cleaning

WARNING!

Risk of Injury / Fires / Chemical Emissions (Fumes) in Pyrolytic Mode.

- Before carrying out the pyrolytic cleaning and initial preheating remove from the oven cavity:
 - any excess food residues, oil or grease spills / deposits.
 - any removable objects (including shelves, side rails, etc., provided with the appliance) especially any non-stick pots, pans, trays, utensils, etc.
- Read carefully all the instructions for pyrolytic cleaning.
- Keep children away from the appliance while the pyrolytic cleaning operates. The appliance becomes very hot and hot air is released from the front cooling vents.
- Pyrolytic cleaning is a high temperature operation that can release fumes from cooking residues and construction materials, as such consumers are advised to:
 - provide good ventilation during and after the pyrolytic cleaning.
 - provide good ventilation during and after the initial preheating.
- Do not spill or apply water on the oven door during and after the pyrolytic cleaning to avoid damaging the glass panels.
- Fumes released from all pyrolytic ovens / cooking residues as described are not harmful to humans, including children, or persons with medical conditions.
- Keep pets away from the appliance during and after the pyrolytic cleaning and initial preheating. Small pets (especially birds

and reptiles) can be highly sensitive to temperature changes and emitted fumes.

- Non-stick surfaces on pots, pans, trays, utensils etc., can be damaged by the high temperature pyrolytic cleaning operation of all pyrolytic ovens and can be also a source for low level harmful fumes.

2.6 Internal lighting

WARNING!

Risk of electric shock.

- Concerning the lamp(s) inside this product and spare part lamps sold separately: These lamps are intended to withstand extreme physical conditions in household appliances, such as temperature, vibration, humidity, or are intended to signal information about the operational status of the appliance. They are not intended to be used in other applications and are not suitable for household room illumination.
- This product contains a light source of energy efficiency class G.
- Use only lamps with the same specifications.

2.7 Service

- To repair the appliance contact the Authorised Service Centre.
- Use original spare parts only.

2.8 Disposal

WARNING!

Risk of injury or suffocation.

- Contact your municipal authority for information on how to dispose of the appliance.
- Disconnect the appliance from the mains supply.
- Cut off the mains electrical cable close to the appliance and dispose of it.

3. PRODUCT DESCRIPTION

3.1 General overview

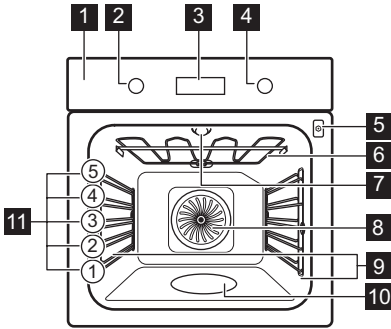

- 1** Control panel
- 2** Knob for the heating functions
- 3** Display
- 4** Control knob
- 5** Socket for the food sensor
- 6** Heating element
- 7** Lamp
- 8** Fan
- 9** Shelf support, removable
- 10** Cavity embossment
- 11** Shelf positions

4. CONTROL PANEL

4.1 Turning the appliance on and off

To turn on the appliance:

1. Press the knobs. The knobs come out.
 2. Turn the knob for the heating functions to select a function.
 3. Turn the control knob to adjust settings.
- To turn off the appliance: turn the knob for the heating functions to the off position **0**.

4.2 Control panel overview

	Press to set timer functions.
	Press to set: Fast Heat Up.
	Press to turn the appliance lamp on and off.
	Press to set the food core temperature with: Food Sensor.
OK	Press to confirm your selection.

4.3 Display indicators

Display with key functions:

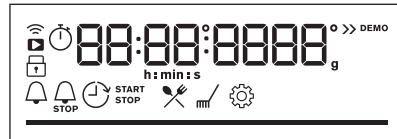

	The appliance is locked.
	Submenu: Assisted Cooking.
	Submenu: Cleaning.
	Submenu: Settings
	Fast Heat Up is activated.
	Steam cooking is activated.
	Food Sensor is activated.
	Minute minder is activated.
	Cooking time is activated.
	Time Delayed Start is activated.
	Uptimer is activated.



Wi-Fi is activated.



Remote operation is activated.

Progress bar - visually indicates when the appliance reaches the set temperature or when the cooking time comes to an end.

5. BEFORE FIRST USE

WARNING!

Refer to Safety chapters.

5.1 Setting the time

After the first connection to the mains, wait until the display shows: "00:00" or "12:00" (depending on the model).

1. Turn the control knob to set the time.
2. Press **OK**.

5.2 Initial preheating and cleaning

Preheat the empty appliance before the first use and contact with food. The appliance can emit unpleasant smell and smoke. Ventilate the room during preheating.

1. Remove all accessories and removable shelf supports from the appliance.
2. Set the function . Set the maximum temperature. Refer to Daily use. Let the appliance operate for 1 h.
3. Set the function . Set the maximum temperature. Let the appliance operate for 15 min.
4. Set the function . Set the maximum temperature. Let the appliance operate for 15 min.
5. Turn off the appliance and wait until it is cold.
6. Clean the appliance and the accessories only with a microfibre cloth, warm water and a mild detergent.
7. Put the accessories and removable shelf supports back to their initial position.

5.3 Wireless connection

To connect the appliance you need:

- Wireless network with the Internet connection.

- Mobile device connected to the same wireless network.
1. To download the app scan the QR code located on the back cover of the user manual. You can also download the app directly from the app store.
 2. Follow the app onboarding instructions.
 3. Turn the knob for the heating functions to select .
 4. Turn the control knob to select / Wi-Fi. Turn it on or off. Refer to "Daily use" chapter, Changing: Settings.

Wi-Fi is turned on by default. Refer to "Energy efficiency" chapter, Energy saving tips.



For safety reasons, remote operation turns off automatically after 24 h. Repeat the onboarding, if needed.

Frequency	2.4 GHz WLAN 2400 - 2483.5 MHz
Protocol	IEEE 802.11b DSSS, 802.11g/n OFDM
Max Power	EIRP < 20 dBm (100 mW)
Wi-Fi module	NIUS-50

United Kingdom is covered by the provision of UK SI 2017, No 1206: Radio Equipment Regulations.

5.4 Software licences

The software in this product contains components that are based on free and open source software. AEG acknowledges the contributions of the open software and robotics communities to the development project.

To access the source code of these free and open source software components whose license conditions require publishing, and to see their full copyright information and

applicable license terms, visit: <http://aeg.opensoftwarerepository.com> (folder NIUS).

6. DAILY USE

WARNING!

Refer to Safety chapters.

6.1 Heating functions



True Fan Cooking

To roast meat and bake cakes. Set a lower temperature than for Conventional Cooking as the fan distributes heat evenly in the oven interior.



Conventional Cooking

To bake and roast food on one shelf position.



SteamBake

To add humidity during the cooking. To get the right colour and crispy crust during baking. To give more juiciness during reheating.



Frozen Foods

To make convenience food crispy, e.g. french fries, potato wedges or spring rolls.



Pizza Function

To bake pizza and other dishes that require more heat from below.



Bottom Heat

To make browning and crispy bottom. Use the lowest shelf position.



Moist Fan Baking

This function is designed to save energy during cooking. When you use this function, the temperature inside the appliance may differ from the set temperature. The residual heat is used. The heating power may be reduced. For more information refer to Daily use, Notes on: Moist Fan Baking.



Grill

To grill thin pieces of food and to toast bread.



Turbo Grilling

To roast large meat joints or poultry with bones on one shelf position. To bake gratins and to brown.



The lamp may turn off automatically at a temperature below 80°C during some oven functions.

6.2 Notes on: Moist Fan Baking

This function was used to comply with the energy efficiency class and ecodesign requirements (according to EU 65/2014 and EU 66/2014). Tests according to: IEC/EN 60350-1.

The oven door should be closed during cooking so that the function is not interrupted and the oven operates with the highest energy efficiency possible.

When you use this function the lamp automatically turns off after 30 sec.

For the cooking instructions refer to Hints and tips, Moist Fan Baking. For general energy saving recommendations refer to Energy efficiency, Energy saving tips.

6.3 Setting: Heating functions

1. Turn the knob for the heating functions to select a heating function.
2. Turn the control knob to set the temperature.

» Fast Heat Up - press and hold to shorten the heating time. It is available for some heating functions. Fan may turn on automatically.

6.4 Setting: SteamBake - Steam cooking

1. Make sure that the appliance is cold.
2. Fill the cavity embossment with maximum 250 ml of tap water.
Do not refill the cavity embossment during cooking or when the appliance is hot.

- Turn the knob for the heating functions to select the heating function .
- Turn the control knob to set the temperature.
- Preheat the empty appliance for 10 min to create humidity.
- Insert the food in the appliance.
- When the cooking ends, turn the knob for the heating functions to the off position to turn off the appliance.
- When the appliance is cold, remove the remaining water from the cavity embossment with a soft cloth.

⚠ WARNING!

Carefully open the door. Released humidity can cause burns.

6.5 Entering: Menu

Open the Menu to access Assisted Cooking dishes and settings.

- Turn the knob for the heating functions to .



The display shows , , , .

- Turn the control knob and select the icon to enter submenu. Press **OK**.

6.6 Setting: Assisted Cooking

Assisted Cooking submenu consists of programmes that are designed for dedicated

dishes. Programmes start with a suitable setting. You can adjust the time and the temperature during cooking.

- Turn the knob for the heating functions to .
- Turn the control knob to select . Press **OK**.
- Turn the control knob to select a dish (P1 - P...). Press **OK**.
- Place the food inside the appliance. Press **OK**.
- When the function ends, check if the food is ready. Extend the cooking time, if needed.

Submenu: Assisted Cooking

Legend



Food sensor must be connected in order to use the function. Refer to Using the accessories.



Fill the cavity embossment with water for steam cooking.



































Preheat the appliance before you start cooking.



































Shelf level. Refer to Product description.

The display shows **P** and a **number** of the dish that you can check in the table.

Dish	Weight	Shelf level / Accessory
P1 Roast beef, rare		
P2 Roast beef, medium	1 - 1.5 kg; 4 - 5 cm thick pieces	  2: baking tray Fry the meat for a few minutes in a hot pan. Insert to the appliance.
P3 Roast beef, well done		
P4 Steak, medium	180 - 220 g per piece; 3 cm thick slices	   3; roasting dish on wire shelf Fry the meat for a few minutes in a hot pan. Insert to the appliance.
P5 Beef roast / braised (prime rib, top round, thick flank)	1.5 - 2 kg	  2; roasting dish on wire shelf Fry the meat for a few minutes in a hot pan. Add liquid. Insert to the appliance.

	Dish	Weight	Shelf level / Accessory
P6	Roast beef, rare (slow cooking)		
P7	Roast beef, medium (slow cooking)	1 - 1.5 kg; 4 - 5 cm thick pieces	  2; baking tray Fry the meat for a few minutes in a hot pan. Insert to the appliance.
P8	Roast beef, well done (slow cooking)		
P9	Fillet of beef, rare (slow cooking)		
P10	Fillet of beef, medium (slow cooking)	0.5 - 1.5 kg; 5 - 6 cm thick pieces	  2; baking tray Fry the meat for a few minutes in a hot pan. Insert to the appliance.
P11	Fillet of beef, done (slow cooking)		
P12	Veal roast (e.g. shoulder)	0.8 - 1.5 kg; 4 cm thick pieces	  2; roasting dish on wire shelf Fry the meat for a few minutes in a hot pan. Add liquid. Insert to the appliance. Roast covered.
P13	Pork roast neck or shoulder	1.5 - 2 kg	  2; roasting dish on wire shelf Add 200 ml liquid to the roasting dish.
P14	Pulled pork (slow cooking)	1.5 - 2 kg	  2; baking tray Turn the meat after half of the cooking time to get an even browning.
P15	Pork loin, fresh	1 - 1.5 kg; 5 - 6 cm thick pieces	  2; roasting dish on wire shelf Fry the meat for a few minutes in a hot pan. Insert to the appliance.
P16	Pork spare ribs	2 - 3 kg; use raw, 2 - 3 cm thin spare ribs	 3; deep pan Add liquid to cover the bottom of a dish. Turn the meat after half of the cooking time.
P17	Lamb leg with bones	1.5 - 2 kg; 7 - 9 cm thick pieces	  2; roasting dish on baking tray Add liquid. Turn the meat after half of the cooking time.
P18	Whole chicken	1 - 1.5 kg; fresh	  2;  200 ml; casserole dish on baking tray Turn the chicken after half of the cooking time to get an even browning.
P19	Half chicken	0.5 - 0.8 kg	  3; baking tray
P20	Chicken breast	180 - 200 g per piece	   2; casserole dish on wire shelf Fry the meat for a few minutes in a hot pan.
P21	Chicken legs, fresh	-	  3; baking tray If you marinated chicken legs first, set lower temperature and cook them longer.

	Dish	Weight	Shelf level / Accessory
P22	Duck, whole	2 - 3 kg	  2; roasting dish on wire shelf Put the meat on roasting dish. Turn the duck after half of the cooking time.
P23	Goose, whole	4 - 5 kg	  2; deep pan Put the meat on deep baking tray. Turn the goose after half of the cooking time.
P24	Meat loaf	1 kg	  2; wire shelf
P25	Whole fish, grilled	0.5 - 1 kg per fish	  2; baking tray Fill the fish with butter, spices and herbs.
P26	Fish fillet	-	  3; casserole dish on wire shelf
P27	Cheesecake	-	 2;  28 cm springform tin on wire shelf
P28	Apple cake	-	  2;  100 - 150 ml; baking tray
P29	Apple tart	-	 2; pie form on wire shelf
P30	Apple pie	-	  2;  100 - 150 ml;  22 cm pie form on wire shelf
P31	Brownies	2 kg of dough	 3; deep pan
P32	Muffins	-	  2;  100 - 150 ml; muffin tray on wire shelf
P33	Loaf cake	-	 2; loaf pan on wire shelf
P34	Baked potatoes	1 kg	 2; baking tray Put the whole potatoes with skin on baking tray.
P35	Wedges	1 kg	 3; baking tray lined with baking paper Cut potatoes into pieces.
P36	Grilled mixed vegetables	1 - 1.5 kg	 3; baking tray lined with baking paper Cut the vegetables into pieces.
P37	Croquettes, frozen	0.5 kg	 3; baking tray
P38	Pommes, frozen	0.75 kg	 3; baking tray
P39	Meat / vegetable lasagna with dry pasta sheets	1 - 1.5 kg	 2; casserole dish on wire shelf
P40	Potato gratin (raw potatoes)	1 - 1.5 kg	 1; casserole dish on wire shelf Rotate the dish after half of the cooking time.

	Dish	Weight	Shelf level / Accessory
P41	Pizza fresh, thin	-	2; 100 ml; baking tray lined with baking paper
P42	Pizza fresh, thick	-	2; baking tray lined with baking paper
P43	Quiche	-	2; baking tin on wire shelf
P44	Baguette / Ciabatta / White bread	0.8 kg	2; 150 ml; baking tray lined with baking paper More time needed for white bread.
P45	Whole grain / Rye / Dark bread	1 kg	2; 150 ml; baking tray lined with baking paper / loaf pan on wire shelf

6.7 Changing: Settings

1. Turn the knob for the heating functions to .
2. Turn the control knob to select . Press OK.
3. Turn the control knob to select the setting. Press OK.
4. Turn the control knob to adjust the value. Press OK.
5. Turn the knob for the heating functions to the off position to exit Menu.

Submenu: Settings

Setting	Value
01 Time of day	Change
02 Display brightness	1 - 5
03 Key tones	1 - Beep, 2 - Click, 3 - Sound off

Setting	Value
04 Buzzer volume	1 - 4
05 Food Sensor Action	1 - Alarm and stop, 2 - Alarm
06 Uptimer	On / Off
07 Light	On / Off
08 Fast Heat Up	On / Off
09 Cleaning Reminder	On / Off
10 Wi-Fi	On / Off
11 Auto remote operation	On / Off
12 Forget network	Yes / No
13 Demo mode	Activation code: 2468
14 Software version	Check
15 Reset all settings	Yes / No

7. ADDITIONAL FUNCTIONS

7.1 Lock

This function prevents an accidental change of the appliance function.

When activated while the appliance is in use, it locks the control panel, ensuring that the current cooking settings continue uninterrupted.

When activated while the appliance is off, it keeps the control panel locked, preventing the appliance from being turned on unintentionally.

OK - press and hold to turn on the function.

A signal sounds. - flashes 3 times when the lock is turned on.

OK - press and hold to turn off the function.

7.2 Automatic switch-off

For safety reasons, if the heating function is active and no settings are changed, the appliance will turn off automatically after a certain period of time.

(°C)	(h)
30 - 115	12.5
120 - 195	8.5
200 - 245	5.5

(°C)	(h)
250 - maximum	3

If you intend to run a heating function for a duration exceeding the automatic switch-off time, set the cooking time. Refer to Clock functions.

The Automatic switch-off does not work with the functions: Light, Food Sensor, Time Delayed Start.

7.3 Cooling fan

When the appliance operates, the cooling fan turns on automatically to keep the surfaces of the appliance cool. If you turn off the appliance, the cooling fan can continue to operate until the appliance cools down.

8. CLOCK FUNCTIONS

8.1 Timer functions description

 Minute minder	To set a countdown timer. When the timer ends, the signal sounds. This function has no effect on the operation of the appliance and can be set at any time.
 Cooking time	To set cooking duration. When the timer ends, the signal sounds and the heating function will automatically turn off.
 Time Delayed Start	To postpone the start and / or end of cooking.
 Uptimer	To show how long the appliance operates. Maximum is 23 h 59 min. This function has no effect on the operation of the appliance and can be set at any time.

8.2 Setting: Minute minder

- Press .
- The display shows: 0:00 and .
- Turn the control knob to set the Minute minder.
 - Press **OK**. The timer starts counting down immediately.

8.3 Setting: Cooking time

- Turn the knobs to select the heating function and to set the temperature.
- Press until the display shows: 0:00 and .
- Turn the control knob to set the Cooking time.
- Press **OK**. The timer starts counting down immediately.
- When the time ends, press **OK** and turn the knob for the heating functions to the off position.



8.4 Setting: Time Delayed Start

- Turn the knobs to select the heating function and to set the temperature.
 - Press until the display shows: and **START**.
 - Turn the control knob to set the start time.
 - Press **OK**.
- The display shows: --:-- **STOP**.
- Turn the control knob to set the end time.
 - Press **OK**.

The timer starts counting down at a set start time.



7. When the time ends, press **OK** and turn the knob for the heating functions to the off position.

8.5 Setting: Uptimer

1. Turn the knob for the heating functions to  to enter Menu.
2. Turn the control knob to select  / Uptimer. Refer to Daily use, Menu: Settings.
3. Press **OK**.

4. Turn the control knob to turn the Uptimer on and off.
5. Press **OK**.

8.6 Setting: Time of day

1. Turn the knob for the heating functions to  to enter Menu.
2. Turn the control knob to select  / Time of day. Refer to Daily use, Menu: Settings.
3. Turn the control knob to set the clock.
4. Press **OK**.

9. USING THE ACCESSORIES

WARNING!

Refer to Safety chapters.

9.1 Inserting accessories

Accessories available depending on model. Scan the QR code to check how to use accessories supplied with your appliance. You can order optional accessories separately. For more information, please contact your local supplier.



A small indentation at the top increases safety and provides tilt protection. The indentations are also anti-tip devices. The rim around the shelf prevents cookware from slipping off the shelf.

Insert the accessory (wire shelf / tray) between the guide bars of the shelf support. Make sure that the shelf touches the back of the oven interior.

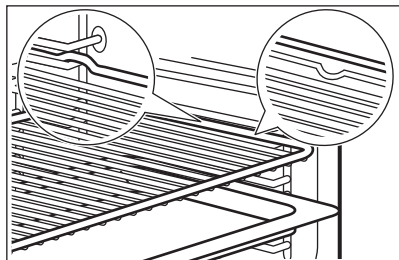

If your tray has a slope, position it towards the back of the oven interior.

If there is an inscription on the accessory, make sure it is facing you.

If you are using a tray with holes place the tray / pan underneath, to collect dripping liquids.

9.2 Trivet and Grill- / Roasting pan

WARNING!

Be careful when you remove the accessories from a hot appliance. There is a risk of burns.

You can use the trivet to roast larger pieces of meat or poultry on one shelf position.

1. Put the trivet into the deep pan so that the supports of the wire shelf point up.

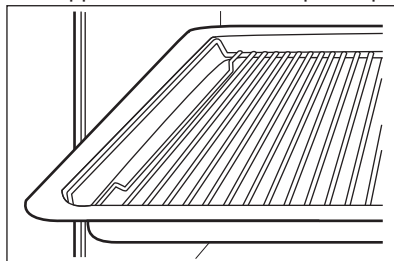

2. Put the deep pan into the appliance on the necessary shelf position.

You can use the trivet to grill flat dishes in large quantities and to toast.

1. Put the trivet into the deep pan so that the supports of the wire shelf point down.

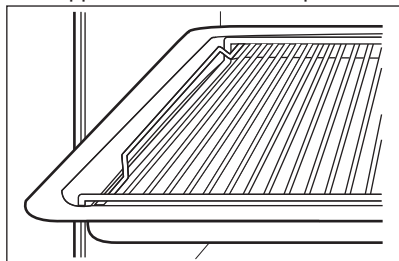

2. Put the deep pan into the appliance on the necessary shelf position.

9.3 Food Sensor

It measures the temperature inside the food.

There are two temperatures to be set:

- °C - the temperature inside the appliance. It should be at least 25°C higher than the food core temperature.
-  - the food core temperature.

Recommendations:

- Ingredients should be at room temperature.
- Do not use it for liquid dishes.
- During cooking the needle of the food sensor must be fully inserted in the dish.

Cooking with: Food Sensor

WARNING!

There is a risk of burns as Food Sensor and shelf supports become hot. Do not touch Food Sensor handle with bare hands. Always use oven gloves.

1. Turn on the appliance.
2. Set a heating function or a dish and, if necessary, the oven temperature.
3. Insert Food Sensor inside the dish:
Meat, poultry and fish
Insert the entire needle of the Food Sensor into the meat or fish at its thickest part.

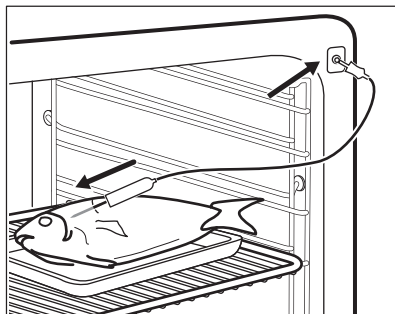

Casserole

Insert the tip of Food Sensor exactly in the centre of the casserole. Food Sensor should be stabilized in one place during cooking. Use a solid ingredient to achieve that. Use the rim of the baking dish to support the silicone handle of Food Sensor. The tip of Food Sensor should not touch the bottom of a baking dish.

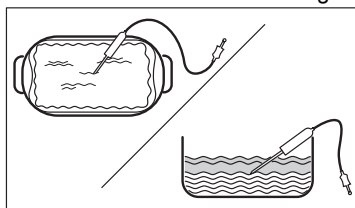

4. Plug Food Sensor into the socket located inside the appliance. Refer to Product description.

The display shows the current temperature of Food Sensor.

5. Turn the control knob to set the temperature.
6. Press OK.
7. When the food reaches the set temperature, the signal sounds. Check if the food is ready. Extend the cooking time, if needed.
8. Remove Food Sensor plug from the socket and remove the dish from the appliance.

10. HINTS AND TIPS

10.1 Cooking recommendations

The temperature and cooking times in the tables are for guidance only. They depend on the recipes, quality and quantity of the ingredients used.



Your appliance may bake or roast differently than your previous appliance. The hints below show recommended settings for temperature, cooking time and shelf position for specific types of food.



Count the shelf positions from the bottom of the oven floor.

If you cannot find the settings for a specific recipe, look for a similar one.

For energy saving tips refer to Energy efficiency.

Symbols used in the tables:

	Food type
	Heating function
	Temperature

	Accessory
	Shelf position
	Cooking time (min)



10.2 Moist Fan Baking - recommended accessories

Use dark and non-reflective tins and containers. They have better heat absorption than light colour and reflective dishes.

- **Pizza pan** - dark, non-reflective, diameter 28 cm
- **Baking dish** - dark, non-reflective, diameter 26 cm
- **Ramekins** - ceramic, diameter 8 cm, height 5 cm
- **Flan base tin** - dark, non-reflective, diameter 28 cm

10.3 Moist Fan Baking





For the best results follow suggestions listed in the table below.

	°C		
Pasta gratin	200 - 220	45 - 55	3
Potato gratin	180 - 200	70 - 85	3
Moussaka	170 - 190	70 - 95	3
Lasagne	180 - 200	75 - 90	3
Cannelloni	180 - 200	70 - 85	3
Bread pudding	190 - 200	55 - 70	3
Rice pudding	170 - 190	45 - 60	3
Apple cake, made of sponge cake mixture (round cake tin)	160 - 170	70 - 80	3
White bread	190 - 200	55 - 70	3

10.4 Information for test institutes

Tests according to: EN 60350-1, IEC 60350-1.

Baking on one level





			°C		
Fatless sponge cake	True Fan Cooking	Wire shelf	160	45 - 60	2
Fatless sponge cake	Conventional Cooking	Wire shelf	160	45 - 60	2
Apple pie ¹⁾	True Fan Cooking	Wire shelf	160	55 - 65	2
Apple pie ¹⁾	Conventional Cooking	Wire shelf	180	55 - 65	1
Shortbread	True Fan Cooking	Baking tray	140	25 - 35	2
Shortbread	Conventional Cooking	Baking tray	140	25 - 35	2
Small cakes, 20 per tray ²⁾	True Fan Cooking	Baking tray	150	20 - 30	3
Small cakes, 20 per tray ²⁾	Conventional Cooking	Baking tray	170	20 - 30	3
Toast ³⁾	Grill	Wire shelf	max.	1 - 2	5

1) 2 tins placed diagonally (Ø 20 cm). The right one to be positioned more in the front than the left one.

2) Preheat the empty appliance.

3) Preheat the empty appliance for 5 min.

Multilevel baking

			°C		
Shortbread	True Fan Cooking	Baking tray	140	25 - 45	2 and 4
Small cakes, 20 per tray ¹⁾	True Fan Cooking	Baking tray	150	25 - 35	2 and 4
Fatless sponge cake	True Fan Cooking	Wire shelf	160	45 - 55	2 and 4
Apple pie	True Fan Cooking	Wire shelf	160	55 - 65	2 and 4

1) Preheat the empty appliance.

11. CARE AND CLEANING

WARNING!

Refer to Safety chapters.

11.1 Notes on cleaning

Cleaning agents

- Clean the front of the appliance only with a microfibre cloth with warm water and a mild detergent.
- Use a cleaning solution to clean metal surfaces.
- Clean stains with a mild detergent.

Everyday use

- Clean the interior of the appliance after each use. Fat accumulation or other residue may cause fire.
- Do not store food in the appliance for longer than 20 minutes. Dry the interior of the appliance only with a microfibre cloth after each use.

Accessories

- Clean all accessories after each use and let them dry. Use only a microfibre cloth

with warm water and a mild detergent. Do not clean the accessories in a dishwasher.

- Do not clean the non-stick accessories using abrasive cleaner or sharp-edged objects.

11.2 Cleaning the cavity embossment

Clean the cavity embossment to remove limestone residue after cooking with steam.



For the function: SteamBake clean the oven every 5 - 10 cooking cycles.

1. Pour 250 ml of white vinegar or citric acid into the cavity embossment. Use maximum 6% acidity vinegar without any additives.
2. Let the vinegar dissolve the limestone residue at the ambient temperature for 30 minutes.
3. Clean the cavity with warm water and a soft cloth.

11.3 Removing the shelf supports

Remove the shelf supports to clean the appliance.

1. Turn off the appliance and wait until it is cold.
2. Pull the front of the shelf support away from the side wall.
3. Pull the rear end of the shelf support away from the side wall and remove it.

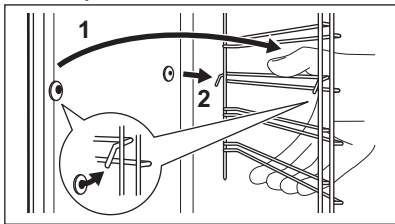

4. Put the shelf supports back to the initial position. Repeat the steps in the reverse order.

If the telescopic runners are supplied, its retaining pins must point to the front.

11.4 Pyrolytic Cleaning



WARNING!

There is a risk of burns.



CAUTION!

If there are other appliances installed in the same cabinet, do not use them at the same time as this function. It can cause damage to the oven.

Do not start the function if you did not fully close the oven door.

1. Make sure that the appliance is cold.
2. Remove all accessories and removable shelf supports.
3. Clean the oven interior and the inner door glass with warm water, a soft cloth and a mild detergent.
4. Turn the knob for the heating functions to to enter Menu.
5. Turn the control knob to select and press OK.

Cleaning programme	Duration
C1 - Light cleaning	1 h
C2 - Normal cleaning	1 h 30 min
C3 - Thorough cleaning	3 h

6. Turn the control knob to select the cleaning programme and press OK.
7. Press OK to start cleaning. When the cleaning starts, the appliance door is locked and the lamp is off. Until the door unlocks the display shows .
8. After cleaning, turn the knob for the heating functions to the off position.
9. Wait until the appliance is cold and the door unlocks. Clean the oven interior with soft cloth and water.

11.5 Cleaning Reminder

When flashes on the display after cooking session, the appliance reminds you to clean it with pyrolytic cleaning. You can turn off the reminder in the submenu: Settings. Refer to Daily use, Changing: Settings.

11.6 Removing and installing door

You can remove the door and the internal glass panels to clean it. The number of glass panels is different for different models.

WARNING!

The door is heavy.

CAUTION!

Carefully handle the glass, especially around the edges of the front panel. The glass can break.

1. Make sure the appliance is cold.
2. Fully open the door.
3. Press the clamping levers **A** on the two door hinges.

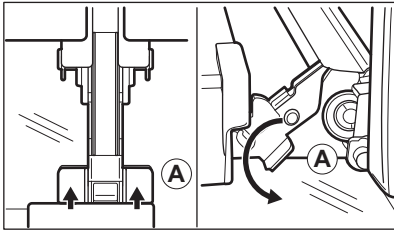

4. Close the oven door to the first opening position (at approximate angle: 70°).
5. Hold the door with one hand on each side and pull it away from the oven at an upwards angle.
6. Put the door with the outer side down on a soft cloth on a stable surface.
7. Hold the door trim **B** on the top edge of the door at the two sides and push inwards to release the clip seal.

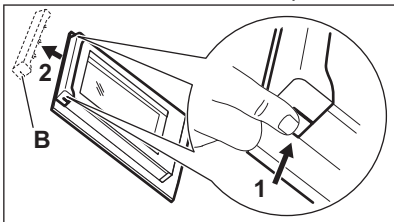

8. Pull the door trim to the front to remove it.

9. Hold the door glass panels on their top edge one by one and pull them up out of the guide.

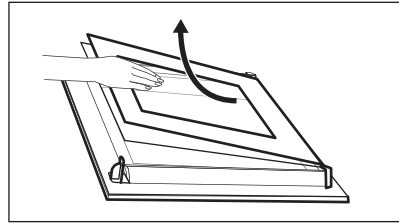

10. Clean the glass panel with water and soap. Dry the glass panel carefully. Do not clean the glass panels in the dishwasher.

After cleaning, do the above steps in the opposite sequence. Install the smaller panel first, then the larger and the door.

Make sure that the glass panels are inserted in the correct position otherwise the surface of the door may overheat.

11.7 Replacing the lamp

WARNING!

Risk of electric shock.
The lamp can be hot.

1. Turn off the appliance and wait until it is cold.
2. Disconnect the appliance from the mains.
3. Place the cloth on the oven floor.

Top lamp

1. Turn the glass cover to remove it.

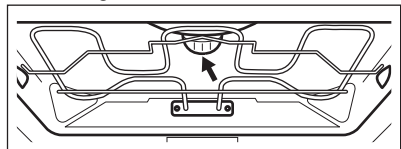

2. Clean the glass cover.
3. Replace the lamp with a suitable 300°C heat-resistant lamp.
4. Install the glass cover.

12. TROUBLESHOOTING

WARNING!

Refer to Safety chapters.

12.1 What to do if...

Problem	Check if...
You cannot activate or operate the appliance.	The appliance is correctly connected to an electrical supply.
The appliance does not heat up.	The automatic switch-off is deactivated.
The appliance does not heat up.	The appliance door is closed.
The appliance does not heat up.	The fuse is not blown.
The appliance does not heat up.	Lock is deactivated.
The lamp is turned off.	Moist Fan Baking - is activated.
The lamp does not work.	The lamp is burnt out.
The Food Sensor does not operate.	The plug of the Food Sensor is fully inserted into the socket.
Err C2	You removed the Food Sensor plug from the socket.
Err C3	The appliance door is closed or the door lock is not broken.
Err F102	The appliance door is closed.
Err F102	The door lock is not broken.
The display shows 00:00.	There was a power cut. Set the time of day.
The water leaks out of the cavity embossment.	There is too much water in the cavity embossment.



If the display shows an error code that is not in this table, turn the house fuse off and on to restart the appliance. If the error code recurs contact an Authorised Service Centre.

12.2 Service data

If you cannot find a solution to the problem yourself, contact your dealer or an Authorised Service Centre.

The necessary data for the service centre is on the rating plate. The rating plate is located on the front frame of the appliance. It is visible when you open the door. Do not remove the rating plate from the appliance.

We recommend that you write the data here:

Model (MOD.):

Product number (PNC):

Serial number (S.N.):

13. ENERGY EFFICIENCY

13.1 Product Information Sheet and Product Information according to EU and UK Energy Labelling and Ecodesign Regulations

Supplier's name	AEG	
Model identification	GA5PB501AB 944035179 GA5PB50FAB 944035249	
Energy Efficiency Index	81.2	
Energy efficiency class	A+	
Energy consumption with a standard load, conventional mode	1.09 kWh/cycle	
Energy consumption with a standard load, fan-forced mode	0.69 kWh/cycle	
Number of cavities	1	
Heat source	Electricity	
Volume	71 l	
Type of oven	Built-In Oven	
Mass	GA5PB501AB	34.0 kg
	GA5PB50FAB	34.0 kg

IEC/EN 60350-1 - Household electric cooking appliances - Part 1: Ranges, ovens, steam ovens and grills - Methods for measuring performance.

13.2 Product information for power consumption and maximum time to reach applicable low power mode

Power consumption in standby	0.8 W
Power consumption in network standby	2.0 W
Maximum time needed for the equipment to automatically reach the applicable low power mode	20 min

For guidance on how to activate and deactivate the wireless network connection, refer to Before first use.

13.3 Energy saving tips

Following tips below will help you save energy when using your appliance.

Make sure that the appliance door is closed when the appliance operates. Do not open the appliance door too often during cooking. Keep the door gasket clean and make sure it is well fixed in its position.

Use metal cookware and dark, non-reflective tins and containers to improve energy saving.

Do not preheat the appliance before cooking unless specifically recommended.

Keep breaks between baking as short as possible when you prepare a few dishes at one time.

Cooking with fan

When possible, use the cooking functions with fan to save energy.

Residual heat

When the cooking duration is longer than 30 min, reduce the appliance temperature to minimum 3 - 10 min before the end of cooking. The residual heat inside the appliance will continue to cook.

Use the residual heat to keep the food warm or warm up other dishes.

When you turn off the appliance, the display shows the residual heat or temperature.

Keep food warm

Choose the lowest possible temperature setting to use residual heat and keep the food warm. The residual heat indicator or temperature appears on the display.

Cooking with the lamp off

Turn off the lamp during cooking. Turn it on only when you need it.

Moist Fan Baking

Function designed to save energy during cooking.

When you use this function the lamp automatically turns off after 30 sec. You may turn on the lamp again but this action will reduce the expected energy savings.

Wi-Fi

When possible, turn off the Wi-Fi to save energy.

14. ENVIRONMENTAL CONCERNS

Recycle materials with the symbol . Put the packaging in relevant containers to recycle it. Help protect the environment and human health by recycling waste of electrical and electronic appliances. Do not dispose of

appliances marked with the symbol  with the household waste. Return the product to your local recycling facility or contact your municipal office.







