

# Instructions for Installation and Use

50 cm Gas Cooker

EN

EN

HD5G00CCW/UK  
HD5G00CCX/UK  
HD5G00CCBK/UK

## Contents

Safety instructions, 2
Features, control panel, 6
Introduction, 7
Installation tips, 8
Electrical Connection, 11
Burner and Nozzle Specifications, 12
Hotplates, 13
Grill, 14
Top Oven Cooking Charts, 15
Electronic Minute Minder, 16
Main Oven, 17
Main Oven Cooking Chart, 18
Using the Main Oven for Other Functions, 19
Care and maintenance, 20
Installation, 22

# EN

---

## SAFETY INSTRUCTIONS

### IMPORTANT TO BE READ AND OBSERVED

⚠ These instructions are valid if the country symbol appears on the appliance. If the symbol does not appear on the appliance, please refer to the technical instructions which will provide the necessary instructions concerning modification of the appliance to the conditions of use of the country.

⚠ CAUTION : Use of the gas cooking appliance results in the production of heat, moisture and products of combustion in the room in which it is installed. Ensure that the kitchen is well ventilated, especially when the appliance is in use: keep natural ventilation holes open or install a mechanical ventilation device (mechanical extractor hood). Prolonged intensive use of the appliance may call for additional ventilation, such as opening a window, or more effective ventilation, for example increasing the level of mechanical ventilation (if possible).

⚠ Failure to follow the information in this manual exactly may cause a fire or explosion, resulting in property damage or personal injury.

Before using the appliance, read these safety instructions. Keep them nearby for future reference.

These instructions and the appliance itself provide important safety warnings, to be observed at all times. The manufacturer declines any liability for failure to observe these safety instructions, for inappropriate use of the appliance or incorrect setting of controls.

⚠ WARNING: The appliance and its accessible parts become hot during use. Care should be taken to avoid touching heating elements. Children less than 8 years of age must be kept away unless continuously supervised.

⚠ WARNING : If the hob surface is cracked, do not use the appliance – risk of electric shock.

⚠ WARNING : Danger of fire : Do not store items on the cooking surfaces.

⚠ CAUTION : The cooking process has to be supervised. A short cooking process has to be supervised continuously.

⚠ WARNING: Leaving the hob unattended when cooking with fat or oil can be dangerous – risk of fire. NEVER try to extinguish a fire with water, but switch off the appliance and then cover the flames e.g. with a lid or a fire blanket.

⚠ Do not use the hob as a work surface or support. Keep clothes or other flammable materials away from the appliance, until all the components have cooled down completely - risk of fire.

⚠ Very young children (0-3 years) should be kept away from the appliance. Young children (3-8 years) should be kept away from the appliance

unless continuously supervised. Children from 8 years old and above and persons with reduced physical, sensory or mental capabilities or lack of experience and knowledge can use this appliance only if they are supervised or have been given instructions on safe use and understand the hazards involved. Children must not play with the appliance. Cleaning and user maintenance must not be carried out by children without supervision.

⚠ CAUTION : In case of hotplate glass breakage:- shut immediately off all burners and any electrical heating element and isolate the appliance from the power supply; - do not touch the appliance surface; -do not use the appliance



The glass lid can break in if it is heated up. Turn off all the burners and the electric plates before closing the lid. Do not shout down lid when burner alight

⚠ WARNING: The appliance and its accessible parts become hot during use. Care should be taken to avoid touching heating elements. Children less than 8 years of age must be kept away unless continuously supervised.

⚠ Never leave the appliance unattended during food drying. If the appliance is suitable for probe usage, only use a temperature probe recommended for this oven - risk of fire.

⚠ Keep clothes or other flammable materials away from the appliance, until all the components have cooled down completely - risk of fire. Always be vigilant when cooking foods rich in fat, oil or when adding alcoholic beverages - risk of fire. Use oven gloves to remove pans and accessories. At the end of cooking, open the door with caution, allowing hot air or steam to escape gradually before accessing the cavity - risk of burns. Do not obstruct hot air vents at the front of the oven - risk of fire.

⚠ Exercise caution when the oven door is in the open or down position, to avoid hitting the door. When you place the rack inside, make sure that the stop is directed upwards and in the back of the cavity.

The device shall not be operated for more 15 s. If after 15s the burner has not lit, stop operating the device and open the compartment door and/or wait at least 1 min before attempting a further ignition of the burner.

### PERMITTED USE

⚠ CAUTION: The appliance is not intended to be operated by means of an external switching device, such as a timer, or separate remote controlled system.

⚠ This appliance is intended to be used in household and similar applications such as: staff kitchen areas in shops, offices and other working environments; farm houses; by clients in hotels,

motels, bed & breakfast and other residential environments.

⚠ No other use is permitted (e.g. heating rooms).

⚠ This appliance is not for professional use. Do not use the appliance outdoors.

⚠ Do not store explosive or flammable substances (e.g. gasoline or aerosol cans) inside or near the appliance - risk of fire.

⚠ Use pots and pans with bottoms the same width as that of the burners or slightly larger (see specific table). Make sure pots on the grates do not protrude beyond the edge of the hob.

⚠ Improper use of the grids can result in damage to the hob: do not position the grids upside down or slide them across the hob.

Do not let the burner flame extend beyond the edge of the pan

Do not use : Cast iron griddles, ollar stones, terracotta pots and pans. Heat diffusers such as metal mesh, or any other types. Two burners simultaneously for one receptacle (e.g. Fish kettle).

Should particular local conditions of the delivered gas make the ignition of burner difficult, it is advisable to repeat the operation with the knob turned to small flame setting.

In case of installation of a hood above the cooktop, please refer to the hood instructions for the correct distance.

The protective rubber feet on the grids represent a choking hazard for young children. After removing the grids, please ensure that all the feet are correctly fitted.

## INSTALLATION

⚠ The appliance must be handled and installed by two or more persons - risk of injury. Use protective gloves to unpack and install - risk of cuts.

⚠ The electrical and gas connections must comply with local regulation.

⚠ Installation, including water supply (if any), electrical connections and repairs must be carried out by a qualified technician. Do not repair or replace any part of the appliance unless specifically stated in the user manual. Keep children away from the installation site. After unpacking the appliance, make sure that it has not been damaged during transport. In the event of problems, contact the dealer or your nearest Aftersales Service. Once installed, packaging waste (plastic, styrofoam parts etc.) must be stored out of reach of children - risk of suffocation. The appliance must be disconnected from the power supply before any installation operation - risk of electric shock. During installation, make sure the appliance does not damage the power cable - risk of fire or electric shock. Only activate the appliance when the installation has been completed.

⚠ WARNING : Modification of the appliance and its method of installation are essential in order to use the appliance safely and correctly in all the additional countries

⚠ Use pressure regulators suitable for the gas pressure indicated in the instruction.

⚠ The room must be equipped with an air extraction system that expels any combustion fumes.

⚠ The room must also allow proper air circulation, as air is needed for combustion to occur normally. The flow of air must not be less than 2 m<sup>3</sup>/h per kW of installed power.

⚠ The air circulation system may take air directly from the outside by means of a pipe with an inner cross section of at least 100 cm<sup>2</sup>; the opening must not be susceptible to blockages.

⚠ The system can also provide the air needed for combustion indirectly, i.e. from adjacent rooms fitted with air circulation tubes as described above. However, these rooms must not be communal rooms, bedrooms or rooms that may present a fire hazard.

⚠ Liquid petroleum gas sinks to the floor as it is heavier than air. Therefore, rooms containing LPG cylinders must also be equipped with vents to allow gas to escape in the event of a leak. This means LPG cylinders, whether partially or completely full, must not be installed or stored in rooms or storage areas that are below ground level (cellars, etc.). It is advisable to keep only the cylinder being used in the room, positioned so that it is not subject to heat produced by external sources (ovens, fireplaces, stoves, etc. ) which could raise the temperature of the cylinder above 50°C.

Should you find it difficult to turn the knobs for the burner, please contact the After-sales Service, who can replace of the burner tap if found to be faulty.

The openings use for the ventilation and dispersion of heat must never be covered.

⚠ Carry out all cabinet cutting works before fitting the appliance in place and remove all wood chips and sawdust.

Do not remove the appliance from its polystyrene foam base until the time of installation.

⚠ If the appliance is not installed above an oven, a separator panel (not included) must be installed in the compartment under the appliance.

Connection with rigid pipe (copper or steel):

If the gas pressure is different from the recommended pressure, a suitable pressure regulator must be fitted to the inlet pipe in accordance with the current national regulations. Use an appropriate cabinet to ensure that the appliance operates properly: To install the oven under the counter (see diagram) or in a kitchen unit, the cabinet must have the dimensions as the picture.

To ensure adequate ventilation, the back panel of the cabinet must be removed. It is advisable to install the oven so that it rests on two strips of wood, or on a completely flat surface with an opening of at least 45 x 560 mm as the picture.

⚠ Do not install the appliance behind a decorative door - risk of fire.

⚠ If the appliance is installed under the worktop, do not obstruct the minimum gap between the worktop and the upper edge of the oven - risk of burns.

⚠ If the range is placed on a base, it must be leveled and fixed to the wall by the retention chain provided, to prevent the appliance slipping from the base.

⚠ **WARNING:** In order to prevent the appliance from tipping, the retention chain must be installed. Refer to the instructions for installation.

### **GAS CONNECTION**

⚠ **WARNING :** Prior to installation, ensure that the local distribution conditions (type of gas and gas pressure) and the configuration of the appliance are compatible.

⚠ Check that the pressure of the gas supply is consistent with the values indicated in Table 1 ("Burner and nozzle specifications").

⚠ **WARNING :** The configuration conditions of this appliance are stated on the label (or data plate).

⚠ **WARNING :** This appliance is not connected to a combustion products evacuation device. It must be installed and connected in accordance with current installation regulations. Particular attention must be paid to the relevant requirements regarding ventilation.

⚠ If the appliance is connected to liquid gas, the regulation screw must be fastened as tightly as possible.

⚠ **IMPORTANT :** When the gas cylinder or gas container is installed, it must be properly settled (vertical orientation).

⚠ **WARNING :** This operation must be performed by a qualified technician

⚠ Use only flexible or rigid metal hose for gas connection.

⚠ Connection with a rigid pipe (copper or steel)  
Connection to the gas system must be carried out in such a way as not to place any strain of any kind on the appliance. There is an adjustable L-shaped pipe fitting on the appliance supply ramp and this is fitted with a seal in order to prevent leaks. The seal must always be replaced after rotating the pipe fitting (the seal is provided with the appliance). The gas supply pipe fitting is a threaded 1/2 gas cylindrical male attachment.

⚠ Connecting a flexible jointless stainless steel pipe to a threaded attachment

The gas supply pipe fitting is a threaded 1/2 gas cylindrical male attachment. These pipes must be installed so that they are never longer than 2000 mm when fully extended. Once connection has been made, make sure that the flexible metal pipe does not touch any moving parts and is not compressed. Only use pipes and seals that comply with current national regulations.

⚠ **IMPORTANT :** If a stainless steel hose is used, it must be installed so as not to touch any moving part of the furniture (e.g.drawer). It must pass through an area where there are no obstructions and where it is possible to inspect it across its entire length.

⚠ The appliance should be connected to the main gas supply or to a gas cylinder in compliance with the current national regulations. Before making the connection, make sure that the appliance is compatible with the gas supply you wish to use. If it is not, follow the instructions indicated in the paragraph "Adapting to different types of gas".

⚠ After connection to the gas supply, check for leaks with soapy water. Light up the burners and turn the knobs from max position 1\* to minimum position 2\* to check flame stability.

⚠ Connection to the gas network or the gas cylinder may be carried out using a flexible rubber or steel hose, in accordance with current national legislation.

### **ELECTRICAL WARNINGS**

⚠ **IMPORTANT:** Information about current and voltage consumption is provided on the rating plate.

⚠ The rating plate is on the front edge of the oven (visible when the door is open).

⚠ It must be possible to disconnect the appliance from the power supply by unplugging it if plug is accessible, or by a multi-pole switch installed upstream of the socket in accordance with the wiring rules and the appliance must be earthed in conformity with national electrical safety standards.

⚠ The power cable must be long enough to connect the appliance, once fitted in its housing, to the main power supply. Do not pull the power supply cable.

⚠ Do not use extension leads, multiple sockets or adapters. The electrical components must not be accessible to the user after installation. Do not use the appliance when you are wet or barefoot. Do not operate this appliance if it has a damaged power cable or plug, if it is not working properly, or if it has been damaged or dropped.

⚠ If the supply cord is damaged, it must be replaced with an identical one by the manufacturer, its service agent or similarly qualified persons in order to avoid a hazard - risk of electric shock.



---

⚠ If the power cable needs to be replaced, contact an authorised service centre.

⚠ **WARNING:** Ensure that the appliance is switched off before replacing the lamp to avoid the possibility of electric shock.

### **CLEANING AND MAINTENANCE**

⚠ **WARNING:** Ensure that the appliance is switched off and disconnected from the power supply before performing any maintenance operation; never use steam cleaning equipment - risk of electric shock.

⚠ Do not use harsh abrasive cleaners or metal scrapers to clean the door glass since they can scratch the surface, which may result in shattering of the glass.

⚠ Do not use abrasive or corrosive products, chlorine-based cleaners or pan scourers.

⚠ Make sure the appliance has cooled down before cleaning or performing maintenance. - risk of burns.

⚠ **WARNING:** Switch off the appliance before replacing the lamp - risk of electric shock.

⚠ To avoid damaging the electric ignition device, do not use it when the burners are not in their housing.

Wear protective gloves for cleaning and maintenance.

### **DISPOSAL OF PACKAGING MATERIALS**

The packaging material is 100% recyclable and is marked with the recycle symbol . The various parts of the packaging must therefore be disposed of responsibly and in full compliance with local authority regulations governing waste disposal.

### **DISPOSAL OF HOUSEHOLD APPLIANCES**

This appliance is manufactured with recyclable or reusable materials. Dispose of it in accordance with local waste disposal regulations. For further information on the treatment, recovery and recycling of household electrical appliances, contact your local authority, the collection service for household waste or the store where you purchased the appliance. This appliance is marked in compliance with European Directive 2012/19/EU, Waste Electrical and Electronic Equipment (WEEE). By ensuring this product is disposed of correctly, you will help prevent negative consequences for the environment and human health. The symbol  on the product or on the accompanying documentation indicates that it should not be treated as domestic waste but must be taken to an appropriate collection centre for the recycling of electrical and electronic equipment.

### **ENERGY SAVING TIPS**

Only preheat the oven if specified in the cooking table or your recipe. Use dark lacquered or enamelled baking trays as they absorb heat better.

Use a pressure cooker to save even more energy and time.

### **DECLARATION OF CONFORMITY**

This appliance meets Ecodesign requirements of European Regulation 66/2014 in compliance with the European standard EN 60350-1.

This appliance meets Ecodesign requirements of European Regulation 66/2014 in compliance with the European standard EN 60350-2.

This appliance meets Ecodesign requirements of European Regulation 66/2014 in compliance with the European standard EN 30-2-1

This appliance meets Ecodesign requirements of European Regulation 65/2014 in compliance with the European standard EN 15181.

# Features, panel control

EN

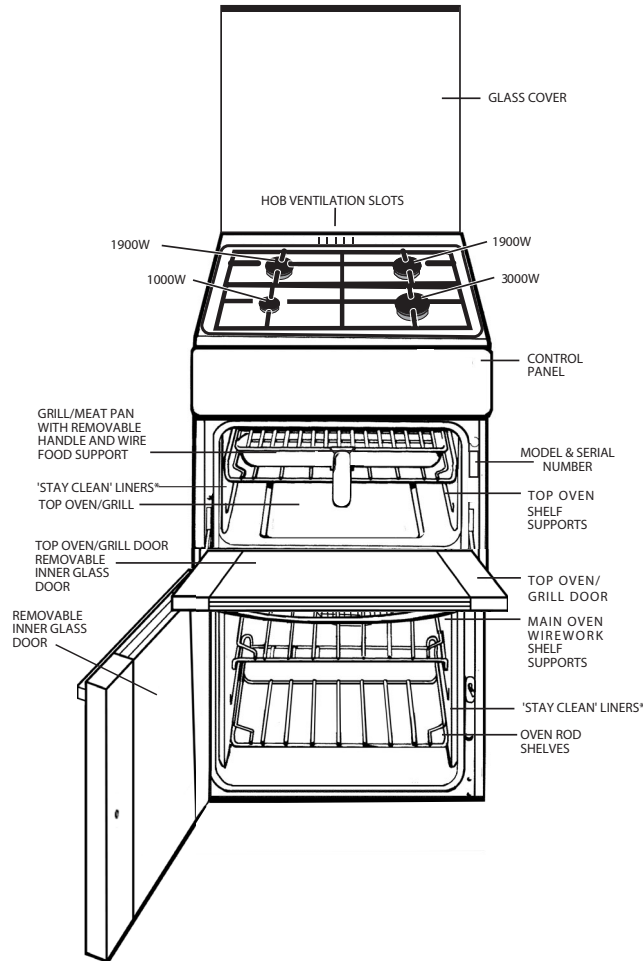

## Panel control

\*Concerns certain models only

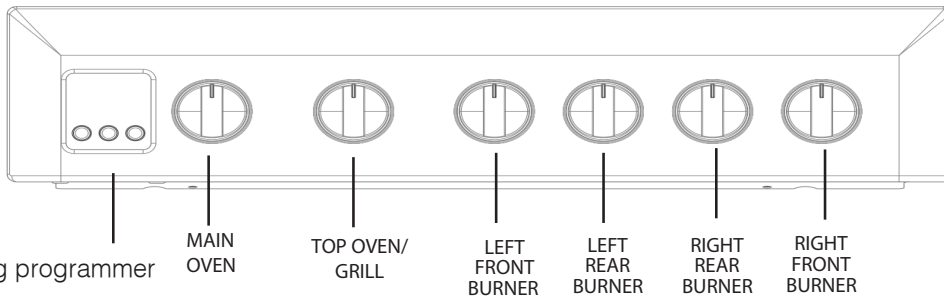

Electronic cooking programmer

MAIN OVEN

TOP OVEN/GRILL

LEFT FRONT BURNER

LEFT REAR BURNER

RIGHT REAR BURNER

RIGHT FRONT BURNER

## BURNER

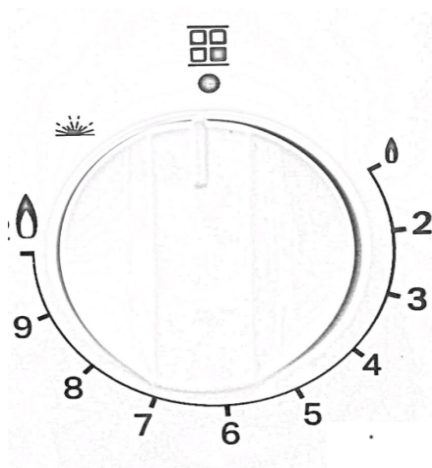

0	Ideal for sauce reduction.
2	Ideal for gentle cooking (e.g.: rice, sauces, roasts, fish) with liquids (water, wine, broth, milk).
3	Ideal for stewing, cooking (for a long period of time) and thickening. Creaming pasta.
4	Ideal for sautéing, maintaining a lively boil.
5	Cooking on a high flame (escalopes, fish fillets, fried eggs).
6	Browning (roasts, steaks).
7	Ideal for frying deep-frozen products, bringing liquids to the boil quickly
8	Ideal for grilling and starting to cook.
9	Ideal for rapidly increasing the temperature of food to a fast boil (for water) or for rapidly heating cooking liquids.
Booster	

# Introduction

EN

## To the Installer:

Before installation, fill in the product details on the back cover of this book.

The information can be found on the rating plate.

## To the User:

You must read the instructions prior to installing and using the appliance and then retain them for future reference.

! Before operating your new appliance please read this instruction booklet carefully. It contains important information concerning the safe operation, installation and maintenance of the appliance.

! Please keep these operating instructions for future reference. Pass them on to possible new owners of the appliance.

## Retention of this Instruction Book

This Instruction Book must be kept handy for reference as it contains important details on the safe and proper use of the appliance.

If you sell or pass the appliance to someone else, or move house and leave it behind, make sure this Book is also provided so the new owner can become familiar with the appliance and safety warnings.

Your new appliance is guaranteed\* and will give lasting service. This guarantee is only applicable if the appliance has been installed in accordance with the installation instructions detailed in this booklet.

To help make best use of your cooking equipment, please read this booklet carefully.

The cooker is designed specifically for domestic use and responsibility will not be accepted for use in any other installation.

## When the cooker is first used an odour may be emitted, this will cease after a period of use.

When first using the cooker ensure that the room is well ventilated (e.g. open a window or use an extractor fan) and that persons who may be sensitive to the odour avoid any fumes.

It is suggested that any pets be removed from the room until the smell has ceased. This odour is due to temporary finish on oven liners and elements and also any moisture absorbed by the insulation.

Your new cooker is guaranteed and will give lasting service.

The guarantee is only applicable if the cooker has been installed in accordance with the Installation Instructions. The cooker is designed specifically for domestic use and responsibility will not be accepted for use in any other installation.

## \* The guarantee is subject to the provisions that the appliance:

(a) Has been used solely in accordance with the Users Instruction Book.

(b) Has been properly connected to a suitable supply voltage as stated on the rating plate attached to this equipment.

(c) Has not been subjected to misuse or accident or been modified or repaired by any person other than the authorised employee or agent.

(d) Has been correctly installed.

Our policy is one of continual improvement in design and development, therefore strict accuracy of illustrations and descriptions cannot be guaranteed.

## Technical Characteristics

**Top Oven** Usable Volume: 32 Litres  
heating mode: Conventional  
**ENERGY LABEL  
and ECODESIGN**

**Main Oven** Usable Volume: 69 Litres  
**ENERGY LABEL  
and ECODESIGN** heating mode: Conventional

**Voltage and Frequency** 220-240V~ 50Hz

**Hob  
ECODESIGN**

## Mains frequency and voltage of the electric section and characteristics of the gas section

Model	Gas section	
	Class	Rated power kW (1)
HD5G00CCW/UK HD5G00CCX/UK HD5G00CCBK/UK	II2H3+	13,90 (1011 g/h - G30) (993 g/h - G31)

(1) The values in g/h refer to the capacities with liquid gas (Butane, Propane).

# Installation tips

**! This procedure must be performed by a qualified technician who has been authorised by the manufacturer.**

EN

Before moving your cooker check that it is cool, and switch off at the cooker control unit. Movement of your cooker is most easily achieved by lifting the front as follows:

Open the grill door sufficiently to allow a comfortable grip on the underside front edge of the oven roof, avoiding any grill elements. (FIG. C)

**! Take care in moving the cooker as it is heavy. Take care to ensure that any floor covering is not damaged.**

Splashplate optional, apply to Parts Department (see Back Cover for contact number.)

The following instructions should be read by a qualified technician to ensure that the appliance is installed, regulated and technically serviced correctly in compliance with current regulations.

## Positioning

**Important:** this unit may be installed and used only in permanently ventilated rooms according to the British Standards Codes Of Practice: B.S. 6172/B.S. 5440, Par. 2 and B.S. 6891 Current Editions. The following requirements must be observed:

**a)** The cooker should not be installed in a bed sitting room with a volume of less than 20m<sup>3</sup>. If it is installed in a room of volume less than 5m<sup>3</sup> an air vent of effective area of 110cm<sup>2</sup> is required, if it is installed in a room of volume between 5m<sup>3</sup> and 10m<sup>3</sup> a supplementary airvent area of 50cm<sup>2</sup> is required, if the volume exceeds 11m<sup>3</sup> no airvent is required. However, if the room has a door or a window which opens directly to the outside no air vent is required even when the volume is between 5m<sup>3</sup> and 11m<sup>3</sup>.

**b)** During prolonged use of the appliance you may consider it necessary to open a window to the outside to improve ventilation.

**c)** If there are other fuel burning appliances in the same room, B.S.5440 Part 2 Current Edition, should, be consulted to determine the requisite air vent requirements.

## Installation of the cooker

For a correct installation of the cooker the following precautions must be followed:

The height of the cooker can be adjusted by means of adjustable feet in the plinth (900mm - 930mm). Adjust the feet by tilting the cooker from the side. Then install the product into position.

NOTE: This appliance must not be fitted on a platform.

The cooker is designed to fit between kitchen cabinets spaced 500mm apart. The space either side need only be sufficient to allow withdrawal of the cooker for servicing. It can be used with cabinets one side or both as well as in a corner setting. It can also be used free-standing. Adjacent side walls which project above hob level, must not be nearer to the cooker than 150mm or 65mm (Fig. A) and should be protected by heat resistant material. Any overhanging surface or cooker hood should not be nearer than 750mm (FigA)

- a)** The cooker may be located in a kitchen, a kitchen/diner or bed sitting room, but not in a bathroom or shower room.
- b)** The hoods must be installed according to the requirements in the hood handbook.
- c)** The wall in contact with the back of the cooker must be of flameproof material.
- d)** The cooker is fitted with a safety chain that must be attached to a hook, secured to the wall behind the appliance.



**! Some models can have their gas connection inverted. It is important to make sure the safety chain is always situated on the side which corresponds to the hose holder (Fig. B).**

Tall cupboard on the right hand side of 50cm gas cooker

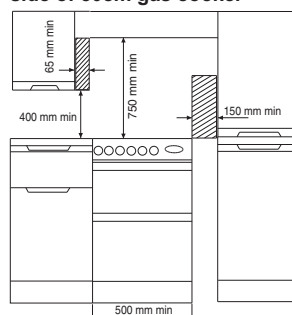

Tall cupboard on the left hand side of 50cm gas cooker

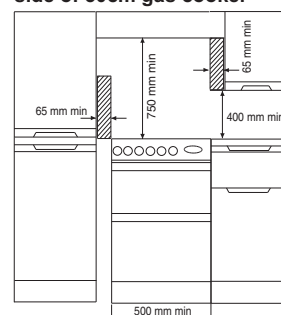

Fig.A



# Installation tips

**! This procedure must be performed by a qualified technician who has been authorised by the manufacturer.**

EN

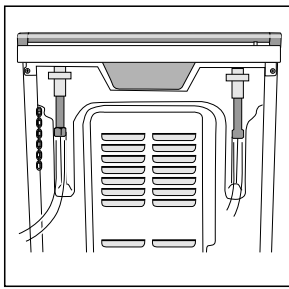

Fig. B

Moving the Cooker

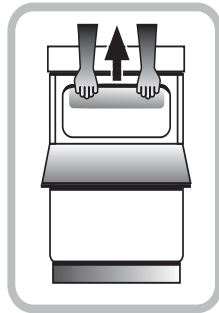
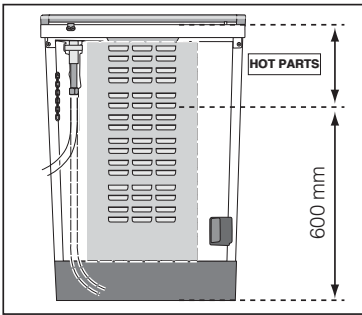

Fig. C

## Gas connection



The cooker should be connected to the gas-supply by a gas safe registered installer. During installation of this product it is essential to fit an approved gas tap to isolate the supply from the appliance

for the convenience of any subsequent removal or servicing. Connection of the appliance to the gas mains or liquid gas must be carried out according to the prescribed regulation in force, and only after it is ascertained that it is adaptable to the type of gas to be used. If not, follow the instructions indicated in the paragraph headed "Adaptation to different gas types". In the case of connection to liquid gas, by tank, use pressure regulators that conform to the regulation in force. The gas supply must be connected to the left of the appliance. Be sure that the hose does not pass through the rear of the cooker touching hot parts.

**! make sure the supply pressure conforms with the values shown in the table entitled "Characteristics of the burners and nozzles".**

**When the cooker is installed between cabinets (recessed), the gas connection must be effected by an approved flexible hose with bayonet fitting (BS 669 Current Edition). The gas inlet for the cookers is a threaded G 1/2 gas female fitting.**

## Connecting the gas supply

To make the connection, a flexible hose should be used corresponding to the current gas regulations which are:

- the hose must never be at any point in its length in contact with the "hot" parts of the cooker;
- the hose must never be longer than 1,5 metre;
- the hose must not be subject to any tension or torsional stress and it must not have any excessively narrow curves or bottlenecks;
- the hose must be easy to inspect along its entire length to check its condition;
- the hose must always be in good condition, never attempt to repair.

**! the installation must comply with gas safety (installation and use) regulations 1984. In all cases for the above, by law, a qualified, gas safe i approved engineer must be called for installation.**

## Adapting the cooker to different types of gas

In order to adapt the cooker to a different type of gas with respect to the gas for which it was produced (indicated on the label attached to the lid), follow these steps:

**a)** replace the hose holder mounted on the appliance with that supplied in the bag of "cooker accessories".

**b)** Replacing the burner nozzles on the hob:

- remove the grids and slide the burners from their housings;
- unscrew the nozzles using a 7 mm socket spanner, and replace them with nozzles for the new type of gas (see table 1 "Burner and nozzle characteristics").
- replace all the components by repeating the steps in reverse order.

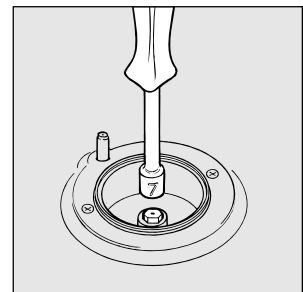

# Installation tips

**! This procedure must be performed by a qualified technician who has been authorised by the manufacturer.**

EN

**c)** Minimum regulation of the hob burners:

- turn the tap to minimum;
- remove the knob and adjust the regulation screw, which is positioned in or next to the tap pin, until the flame is small but steady.

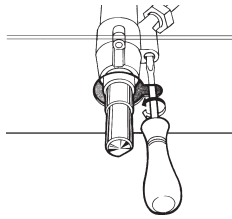

**!** In the case of liquid gas, the regulation screw must be screwed in to the bottom.

- check that the flame does not turn off when you turn the tap quickly from high to low.

**d)** Regulating the primary air of the burners:  
The primary air of the burners requires no regulation.

## Adapting to different types of gas (main and top oven)

In order to adapt the oven to a different type of gas with respect to the gas for which it was manufactured (indicated on the label), follow these simple steps:

- a)** Replacing the oven burner nozzle
- open the oven door fully
  - pull out the sliding oven bottom
  - unscrew the two screws and take off the shield protecting the burner (in main oven burner only).

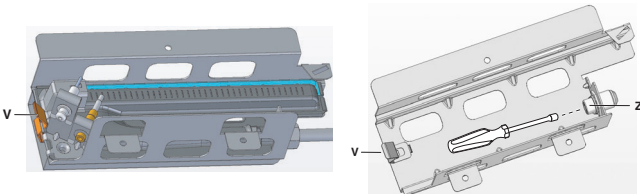

- Pry the fixing tab "V" and remove the oven burner
- Unscrew the oven burner nozzle using the socket spanner for the nozzles "Z", or a 7 mm socket spanner, and replace it with a nozzle suited to the new type of gas (see Table 1).

## Take particular care handling the spark plug wires and the thermocouple pipes.

- Replace all the parts, following the steps described above in the reverse order.

**b)** Minimum regulation of the main and top gas oven burner with thermostat:

- light the burner as described in the paragraph "the oven knob" of the instruction booklet.
- turn the knob to **Max** for about 10 minutes and then turn the knob to the **Min** setting;
- remove the knob;
- regulate the screw positioned outside the thermostat pin until the flame is small but steady.

**!** In the case of liquid gas, the regulation screw must be screwed in to the bottom.

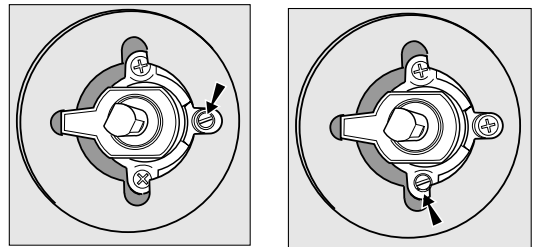

- check that the burner does not turn off **when you turn the knob from Max to Min** and when you open and close the oven door quickly.

## Adapting the gas grill to different types of gas Replacing the nozzle of the grill burner:

- Remove the enamelled baffle at the front of the grill (2 screws).
- Remove the screw on the right hand side of the burner and gently slide the burner off the injector.
- Using a 7mm socket, replace the grill injector as appropriate (see table 1).
- Re-assemble the burner and baffle.

**!** On completion of the operation, replace the old rating sticker with one indicating the new type of gas used. This sticker is available from our Service Centres.

## Note

Should the pressure of the gas used be different (or vary) from the recommended pressure, it is necessary to fit a suitable pressure regulator onto the inlet pipe in compliance with current National Regulations relative to "regulators for channelled gas".

# Electrical Connection

**! This procedure must be performed by a qualified technician who has been authorised by the manufacturer.**

EN

Power supply voltage and frequency: 230-240V a.c. 50/60 Hz.

! The supply cable must be positioned so that it never reaches at any point a temperature 50°C higher than the room temperature. The cable must be routed away from the rear vents. Should you require it, you may use a longer cable, however, you must ensure that the cable supplied with the appliance is replaced by one of the same specifications in accordance with current standards and legislation. Your appliance is supplied with a 13 amp fused plug that can be plugged into a 13 amp socket for immediate use. Before using the appliance please read the instructions below.

## Replacing the fuse:

When replacing a faulty fuse, a 13 amp ASTA approved fuse to BS 1362 should always be used, and the fuse cover re-fitted. If the fuse cover is lost, the plug must not be used until a replacement is obtained.

## Replacement fuse covers:

If a replacement fuse cover is fitted, it must be of the correct colour as indicated by the coloured marking or the colour that is embossed in words on the base of the plug. Replacements can be obtained directly from your nearest Service Depot.

## Removing the plug:

If your appliance has a non-rewireable moulded plug and you should wish to remove it to add a cable extension or to re-route the mains cable through partitions, units etc., please ensure that either:

- the plug is replaced by a fused 13 amp re-wireable plug bearing the BSI mark of approval.
- or:
- the mains cable is wired directly into a 13 amp cable outlet, controlled by a switch, (in compliance with BS 5733) which is accessible without moving the appliance.

! For appliances with a rating greater than 13 amp (eg: electric hob, double ovens and freestanding electric cookers etc.) the mains cable must be wired into a cooker output point with a rating of 45 amp. In this case the cable is not supplied.

Disposing of the plug:

Ensure that before disposing of the plug itself, you make the pins unusable so that it cannot be accidentally inserted into a socket. Instructions for connecting cable to an alternative plug:

! The wires in the mains lead are coloured in accordance with the following code:

Green & Yellow - Earth  
Blue - Neutral  
Brown - Live

If the colours of the wires in the mains lead do not correspond with the coloured markings identifying the terminals in your plug, proceed as follows: Connect Green & Yellow wire to terminal marked "E" or 6 or coloured Green or Green & Yellow. Connect Brown wire to terminal marked "L" or coloured Red. Connect Blue wire to terminal marked "N" or coloured Black.

If a 13 amp plug (BS 1363) is used it must be fitted with a 13 amp fuse. A 15 amp plug must be protected by a 15 amp fuse, either in the plug or adaptor or at the distribution board. If you are in any doubt about the electrical supply to your machine, consult a qualified electrician before use.

## How to connect an alternative plug:

The wires in this mains lead are coloured in accordance with the following code:

**BLUE** "NEUTRAL"  
("N")  
**BROWN** "LIVE"  
("L")  
**GREEN AND YELLOW** "EARTH" ("E")

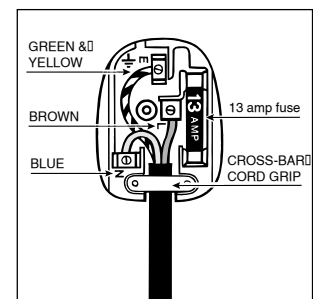

WARNING.

If the electric supply fails to this appliance you must not use the grill or ovens.

# Burner and Nozzle Specifications

**! This procedure must be performed by a qualified technician who has been authorised by the manufacturer.**

EN

Burner	Diameter (mm)		Liquid Gas						Natural Gas			
			Thermal Power kW (p.c.s.*)		By-Pass 1/100 (mm)	Nozzle 1/100 (mm)	Flow* g/h		Thermal Power kW (p.c.s.*)		Nozzle 1/100 (mm)	Flow* l/h
			Nominal	Reduced			***	**	Nominal	Reduced		
Fast (Large)(R)	100	94	3,00	0,7	41	87	218	214	3,00	0,7	128	286
Semi Fast (Medium)(S)	75	69	1,90	0,4	30	70	138	136	1,90	0,4	104	181
Auxiliary (Small)(A)	51	46	1,00	0,4	30	52	73	71	1,00	0,4	76	95
Main Oven	-	-	2,50	0,6	34	71	182	179	2,50	0,6	115	238
Grill	-	-	3,60	2,4	-	94	167	164	3,60	1,4	134	219
Top Oven	-	-	2,00	0,6	34	66	145	143	2,00	0,6	104 (X)	190
Supply Pressures	Nominal (mbar) Minimum (mbar) Maximum (mbar)						28-30 20 35	37 25 45			20 17 25	

\* At 15°C and 1013 mbar- dry gas  
\*\* Propane P.C.S. = 50,37 MJ/Kg

\*\*\* Butane P.C.S. = 49,47 MJ/Kg  
Natural P.C.S. = 37,78 MJ/m<sup>3</sup>

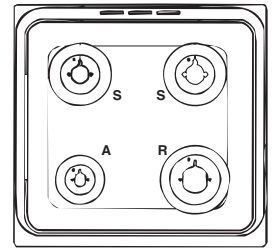

HD5G00CCW/UK  
HD5G00CCX/UK  
HD5G00CCBK/UK

## Electronic Ignition for the Gas Hob

To light a specific burner push the corresponding knob all the way in and turn it counter-clockwise to **maximum** keeping it pressed down until the burner lights.

**Important:** Should the burner flames accidentally go out, turn off the control knob and wait at least 1 minute before trying to relight.

## Control Knobs for the gas burners

The position of the gas burner controlled by each one of the knobs is shown by a solid ring ●. To light one of the burners, press down and turn the corresponding knob counter clockwise to the **maximum** setting. Each burner can be operated at its maximum, minimum or intermediate power. Shown on the knob are the different symbols for off ● (the knob is on this setting when the symbol corresponds with the reference mark on the control knob), for **maximum** and **minimum** . To obtain these settings, turn the knob counter clockwise with respect to the off position. To turn off the burner, turn the knob clockwise until it stops (corresponding again with the ● symbol).

## Models with Hob Gas Burner Safety Devices to Prevent Leaks\*

These models can be identified by the presence of the device itself.

**!** Since the hob burners are equipped with a safety device, you must hold the control knob in for about 3-7 seconds after the burner has been lighted to allow the gas to pass until the safety thermocouple has heated.

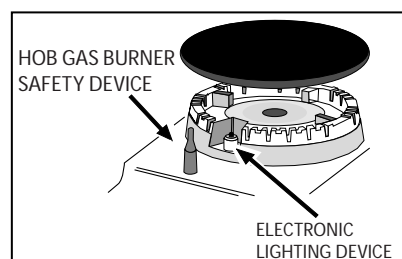

\*Only on certain models



# Hotplates

## Gas Cut Off

This cooker has a safety cut out feature which switches off the burners when you close the cover. This device is provided as a safety feature in case the cover is lowered with the burners on.

### Practical Advice on Using the Burners

To use the burners as efficiently as possible, some basic guidelines should be followed:

- Use cookware that is the right size for each burner (see table) in order to prevent the flame from spreading beyond the bottom of the cookware.
- Only use cookware with flat bottoms.
- As soon as the boiling point is reached, turn the knob to the lowest setting.
- Always use lids with pots and pans.

Burner	ř Cookware diameter (cm)
Fast (R)	20 - 24
Semi Fast (S)	16 - 20
Auxiliary (A)	10 - 14

! On models equipped with a reduction grid, the grid should only be used with the auxiliary burner when cookware with a diameter of less than 12 cm is used.

1. To light a specific burner push the corresponding knob all the way in and turn it counter-clockwise to **maximum**  keeping it pressed down until the burner lights.
2. Turn the control knob anti-clockwise to the desired setting. Only turn the control knob between the large flame symbol and the small flame symbol for adjusting the setting.
3. To turn off, turn the control knob fully clockwise to the symbol **O**.

Each burner is fitted with a spark ignitor for lighting the gas. To ensure rapid lighting of the burners every time they are used, the ignitors must be kept **clean and dry**. Remove any food spillage or cleaning materials from the electrode using a small nylon brush such as a tooth brush. Access to the electrode can be achieved by lifting off the loose burner parts carefully when the burners are cool. When the hotplate burner bodies and caps are removed for cleaning, be careful not to drop any food particles or cleaning materials into the burner bases, to avoid the possibility of blocking the gas jets.

If aluminium based pans are used, a silvery deposit may appear on the top edge of the pan support fingers. See 'Care and Cleaning' section for cleaning information.

After prolonged use of the gas hob there may be some small amount of discolouration in the area around the large burners. This is normal and can be easily removed using propriety stainless steel cleaning agents.

# Grill

EN

The grill is fitted with a safety device that will cut off the gas supply to the burner if the flame is extinguished for any reason. Each time the grill is used, the safety device has to be activated by pushing and holding in the control knob for 3 seconds after the gas has lit.

A gentle flow of air will be blown from underneath the control panel when the grill or top oven is in use. If the fan fails to blow air when the grill is in use, you must stop using and switch off the grill burner immediately and contact our service department.

## Grill Pan Handle

The grill pan handle is detachable from the pan to facilitate cleaning and storage. Fix the pan handle securely before use:

1. Fit the handle to the grill pan so that the external 'hooks' embrace the edge of the pan (fig. 1)
2. Make sure that the middle part of the handle fits exactly the protruding support of the pan (fig. 2) and holds the pan from the bottom.

The food must be placed on the rack in the grill pan. Position the grill pan on top of the oven rack. Pouring a little water into the grill pan will make the collection of grease particles more efficient and prevent the formation of smoke.

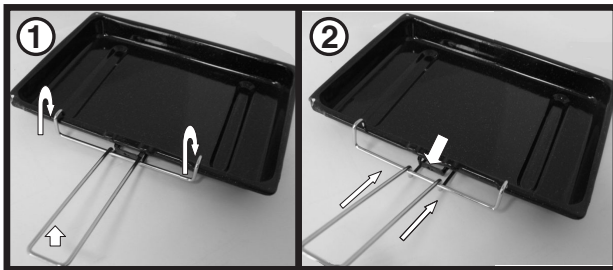

The grill pan can be stored in the top compartment with the handle attached by placing the shelf in the middle or lower position and tilting the grill pan over the rear edge of the shelf.

**! To achieve the quickest grilling results, place the rack on the 4th (the uppermost) position. To grill food more evenly choose the rack position 2 or 3.**

## TO USE THE GRILL

1. Open the top oven/grill door and remove the grill pan.
2. Place the shelf in the appropriate position.
3. Push and turn the control knob clockwise to the large flame symbol. Continue to push in the control knob for a further 3 seconds after the gas has lit, to allow time for the safety device to operate. If the burner extinguishes when the control knob is released, repeat the procedure ensuring the control knob is fully depressed and allowing more time for the safety device to operate.
4. Ensure that the appliance is connected to the correct electrical supply and that the supply is switched on.
5. Slide the grill pan along the shelf towards the rear of the grill compartment until it stops.
6. Turn the control knob anti-clockwise to reduce the heat input. Only turn the control knob between the large flame symbol and the small flame symbol when adjusting the setting.
7. To turn off, turn the control knob anti-clockwise to the symbol •.

The grill cannot be used at the same time as the top oven. If for any reason the grill burner has not lit after 15 seconds, turn the control knob to the off position, leave the grill door open and wait for at least one minute before attempting to light the burner again. An odour may be noticed when first using the grill - this should cease after a short period of use.

Use the grill with the door open.

Do not cover the grill pan or grid with aluminium foil as this can hold fat, intensify the heat and create a fire hazard.

## RELIGHTING THE BURNER

In the event of the burner flames being accidentally extinguished, turn off the burner control and do not attempt to re-ignite the burner for at least one minute. Grilling can be started from cold but for best results preheat for approximately two minutes. Most cooking is done with the heat on full, but it may be desirable to reduce it for thicker pieces of meat or for keeping food warm.

For au gratin dishes eg. Macaroni Cheese and meringue toppings eg. Baked Alaska, place the dish on the floor of the grill compartment. The base of the grill pan can be used for warming fruit garnishes on the reduced setting.

**NOTE:** Strong detergents used in dishwashers may damage the grill pan grid finish; clean in soapy water as described in CARE AND CLEANING section. Always ensure that the grill pan handle is correctly fitted to the grill pan.

# Top Oven Cooking Chart

The top oven can be used to cook small quantities of food or used in conjunction with the main oven to provide additional cooking space.

The top oven is fitted with a safety device that will cut off the gas supply to the burner if the flame is extinguished for any reason. Each time the top oven is used, the safety device has to be activated by pushing and holding in the control knob for 5 seconds after the gas has lit.

A gentle flow of air will be blown from underneath the control panel when the grill or top oven is in use. If the fan fails to blow air when the top oven is in use, you must stop using and switch off the oven burner immediately and contact our service department.

## TO USE THE TOP OVEN

- 1 Place the top oven shelf in the appropriate position (refer to cooking chart).
2. Ensure that the appliance is connected to the correct electrical supply and switched on
- 3 Push in and turn the control knob fully anti-clockwise. Continue to push in the control knob for at least a further 5 seconds after the gas has lit to allow time for the safety device to operate. If the burner extinguishes when the control knob is released, repeat the procedure ensuring the control knob is fully depressed and allowing more time for the safety device to operate.
- 4 Turn the control knob clockwise to the required setting. (refer to cooking chart).
- 5 To turn off, turn the control knob clockwise to the symbol ● .
- 6 The oven temperature control marking are gas marked 0 to 9.

Always push the door firmly closed to ensure that there is no loss of heat through the door seal.

The equivalent degrees Celsius (sometimes called Centigrade) and degrees Fahrenheit are shown below as a guide.

Gas Mark	Fahrenheit	Celsius	Description
1	275	140	cool
2	300	150	---
3	325	170	very moderate
4	350	180	moderate
5	375	190	---
6	400	200	moderately hot
7	425	220	hot
8	450	230	---
9	475	240	very hot

## GUIDANCE ON USING THE TOP OVEN

- 1 Best results are obtained by pre-heating the oven for about 15 minutes.
- 2 Food which is higher than or will rise above 125mm (5") cannot be cooked in the top oven.

Never place dishes over the burner.

An odour may be noticed when first using the oven—this should cease after a short period of use.

The following times and setting are for guidance only. You may wish to alter the setting to give a result more to your satisfaction. When a different setting to that shown below is given in a recipe, the recipe instructions should be followed. Allow 15 minutes preheat for best results. Always turn the thermostat knob to Mark 8 first, before turning back to the required Gas Mark.

Shelf position 1 is the highest.

If using aluminium foil:

- 1 Remember it is important to increase the cooking time by one third.
- 2 Do not allow the foil to touch the sides of the oven.
- 3 Do not cover the oven interior with foil.
- 4 Do not cover the oven shelves with foil.

**Soft Margarine** – Use the oven settings recommended by the margarine manufacturer and **not** those indicated on the cooking chart.

Food	Gas Mark	Shelf Position	Approx. Cooking Time and Comments
<b>FISH</b>			
Olly and white fish	5	2	20-30 mins.
<b>MEAT AND POULTRY</b>			
Beef (medium)	4 or 5	3	25-30 mins per lb + 25-30 mins
Ham (covered in foil)	5	3	40 mins per lb + 40 mins
Lamb	5	3	30-35 mins per lb + 30 mins
Pork	5	3	40 mins per lb + 40 mins
Chicken	5	3	25 mins per lb + 25 mins
Duckling & Goose	5	3	25 mins per lb + 25 mins
Turkey	4	3	15-20 mins per lb + 15-20 mins
Casseroles	3	3	2-4 hrs. depending on meat used.
<b>VEGETABLES</b>			
Baked jacket potatoes	5	2	1 1/2 - 2 hrs.
<b>PUDDINGS</b>			
Milk Puddings (500ml/1pt)	3	2	1 1/2 - 2 hrs.
Baked Custard (500ml/1pt)	3	2	45 mins - 1 hr. in bain-marie of cold water.
Baked Sponge Puddings	4	2	30 - 45 mins
Baked Apples	3	2	45 mins - 1 hr. depending on size
Meringue Topped Puddings	1	2	25 mins until tinged with brown
Apple Tart (1 x 205mm/8Ø)	6	2	60 mins
Fruit Crumble	5	2	45 - 50 mins

Food	Gas Mark	Shelf Positions	Approx. Cooking Time and Comments
<b>CAKES, PASTRIES AND BISCUITS</b>			
Small Cakes (16 per tray)	5	2	20 - 25 mins.
Victoria sandwich (2 x 180mm / 7Ø)	4	2	25 - 30 mins.
Swiss Roll (3 egg quantity)	6	2	10 - 12 mins.
Christmas cake (1 x 205mm / 8Ø)	2	2	4 - 5 hrs depending on recipe
Madeira cake (1 x 180mm / 7Ø)	4	2	1 hr.
Rich Fruit cake (1 x 180mm / 7Ø)	2	2	2 1/2 - 2 1/2 hrs.
Gingerbread	3	2	1 1/2 - 1 1/4 hrs.
Scones - 16 per tray	7	2	12 - 15 mins.
Shortbread (1 x 180mm / 7Ø)	2	2	45 mins. Ø 1 hr depending on thickness
Biscuits	4-6	2	15 - 25 mins.
Shortcrust Pastry	6	2	15 mins. Ø 1 hr depending on recipe
Rich Short Crust	5	2	20 - 30 mins.
Flaky/Puff Pastry	7	2	10 - 30 mins. depending on recipe
Choux Pastry	6	2	25 - 35 mins.
<b>YEAST MIXTURES</b>			
Bread - rolls, plait	7	2 or 3	25 - 35 mins
Tea breads etc.	5	2	25 - 30 mins
<b>MISCELLANEOUS</b>			
Yorkshire Pudding - small	7	2	20 - 25 mins
- large	7	2	30 - 40 mins
Meringues	1	3	2 1/2 - 4 hrs. turn when necessary

# Electronic Minute Minder





EN

## Electronic Timer

The electronic timer displays the time and the timer function with countdown.

To set the clock





Note: This may be set while the oven is switched off or while it is switched on.

1. Press the  button several times until the  icon and the first two numerical digits on the watch display start to flash.
2. Use the "+" and "-" buttons to adjust the hour value.
3. Press the  button again so that the other two numerical digits on the DISPLAY begin to flash.
4. Use the "+" and "-" buttons to adjust the minute value.
5. Press the  button again to confirm.

Note: If none of the buttons are pressed, the settings will be confirmed automatically after 10 seconds have passed.

## To set the minute minder

**! This function does not interrupt cooking and does not affect the oven; it is simply used to activate the buzzer when the set amount of time has elapsed.**

1. Press the  button several times until the  icon and the first two numerical digits on the display start to flash.
2. Use the "+" and "-" buttons to adjust the hour value.
3. Press the  button again so that the other two numerical digits on the DISPLAY begin to flash.
4. Use the "+" and "-" buttons to adjust the minute value.
5. Press the  button again to confirm.

The countdown will then be displayed; at the end of this period of time the buzzer will sound (this may be stopped by pressing any of the buttons, or it will stop of its own accord after one minute).

## To cancel a previous setting

Press the  button and then "-" up until **0 : 00**.



# Main Oven

## WARNING – DO NOT USE THE MAIN OVEN WITHOUT AN ELECTRICAL SUPPLY TO THE COOKER

The main oven is fitted with a safety device that will cut off the gas supply to the burner if the flame has been extinguished for any reason. Each time the main oven is used, the safety device has to be activated by pushing and holding in the control knob for 3 seconds after the gas has lit.

The oven has different heat zones - the thermostat settings refer to the temperature on the middle shelf position; above this shelf it is hotter and below it is cooler. Two shelves provide five possible cooking levels enabling full use of the different temperatures inside the oven.

The maximum size of baking tray that should be used is 325mm x 350mm (13" x 14").

## TO USE THE MAIN OVEN

1. Place the oven shelves in the appropriate positions (refer to cooking charts).
2. Push in and turn the control knob fully anti-clockwise. Continue to push in the control knob for a further 3 seconds after the gas has lit to allow time for the safety device to operate. If the burner extinguishes when the control knob is released, repeat the procedure ensuring the control knob is fully depressed and allowing more time for the safety device to operate.
3. Turn the control knob clockwise to the required setting (refer to cooking chart).
4. Ensure that the appliance is connected to the correct electrical supply and that the supply is switched on.
5. To turn off, turn the control knob fully clockwise the the symbol "o" .
6. The oven temperature control marking are gas marked 0 to 9.

The equivalent degrees Celsius (sometimes called Centigrade) and degrees Fahrenheit are shown below as a guide.

Gas Mark	Fahrenheit	Celsius	Description
1	275	140	cool
2	300	150	---
3	325	170	very moderate
4	350	180	moderate
5	375	190	---
6	400	200	moderately hot
7	425	220	hot
8	450	230	---
9	475	240	very hot

If for any reason the oven burner has not lit after 15 seconds, turn the control knob to the OFF position. Leave the main oven door open and wait for at least 1 minute before attempting to light the burner again.

Never place dishes over the burner.

An odour may be noticed when first using the oven - this should cease after a short period of use.

## RELIGHTING THE BURNER

In the event of the burner flames being accidentally extinguished, turn off the burner control and do not attempt to re-ignite the burner for at least one minute.

## COLD START COOKING

Anything requiring long slow cooking such as casseroles and rich fruit cakes can be put into a cold oven. Satisfactory results can also be obtained with creamed mixture, rich pastries or yeast mixtures, but for perfection we recommend preheating the oven for about 15 minutes at the gas mark you require for cooking.

## ROASTING OF LARGE POULTRY

The maximum weight of poultry that can be accommodated is 11.5kg (25 lbs) of suitable shape. It is important to check that the bird DOES NOT overhang the burner at the back of the oven.

## STORAGE AND RE-HEATING OF FOOD

It is vitally important to strictly adhere to the basic principles of food handling and hygiene to prevent the possibility of bacterial growth.

1. If food is to be frozen or not served immediately, cool it in a clean container as quickly as possible.
2. Completely thaw frozen food in the refrigerator before re-heating.
3. Re-heat food thoroughly and quickly either on the hotplate or in a hot oven, Mk. 6, and then serve immediately.
4. Only re-heat food once.

## 'COOK CHILL' DISHES

These should always be placed in a pre-heated oven ideally on the first or second shelf position. Follow the packet instructions for cooking time.

# Main Oven Cooking Chart

EN

The following times and setting are for guidance only. You may wish to alter the setting to give a result more to your satisfaction. When a different setting to that shown below is given in a recipe, the recipe instructions should be followed.

Allow 15 minutes preheat for best results. Always turn the thermostat knob to Mark 9 first, before turning back to the required Gas Mark. Shelf position 1 is the highest.

Food	Gas Mark	Shelf Position	Approx. Cooking Time and Comments
<b>Fish</b>			
Oily and white fish	3 or 4	4	25-60 mins. depending on recipe
<b>Meat and Poultry</b>			
Beef	4 or 5	4	25-30 mins per 450g (1 lb) + 25 mins. extra
Ham	5	4	40 mins per 450g (1 lb) covered in foil plus 40 mins. extra
Lamb	5	4	30 mins per 450g (1 lb) + 30 mins extra
Pork	5	4	40 mins per 450g (1 lb) + 40 mins extra
Chicken	5	4	25 mins per 450g (1 lb) + 25 mins extra
Duckling & Goose	5	4	25 mins per 450g (1 lb) + 25 mins extra
Turkey	4 or 5	4 or 5	15-20 mins per 450g (1 lb) + 20 mins
Casseroles	3	3or4	2-6 hrs. depending on cut of meat
<b>Vegetables</b>			
Baked jacket potatoes	4 or 5	3	1½ - 3 hrs. until soft, depending on size
<b>Puddings</b>			
Milk Puddings (500ml/1 pt)	3	4	1¼-2½ stand dish on baking tray and started with warm milk
Baked Custard (500ml/1 pt)	3	4	45-60 mins. bain-marie
Baked Sponge Puddings	4	3	40-50 mins
Baked Apples	3	3	30-45 mins depending on type and size of apples
Meringue Topped Puddings	1	3or4	15 mins or until "tinged" with brown
Apple Tart (1 x 205mm/8")	6	2	45-60 mins
Fruit Crumble	5	2	35 -45 mins
<b>Cakes, Pastries &amp; Biscuits</b>			
Small Cakes 2 trays	5	2 and 4	15-25 mins.
1 tray	5	2	15-22mins.
Victoria sandwich (2 x 7")	4	2 and 4	20-30 mins
Swiss Roll (3 egg quantity)	5	2	15-20 mins.
Meringues	1	3	2-3 hrs
Christmas cake (1 x 205mm / 8")	2	3	Time depending on recipe
Madeira cake (1 x 180mm / 7")	4	4	1¼-1½ hrs.
Rich Fruit cake (1 x 180mm / 7")	2	4	Time depending on recipe
Scones	7	1 and 3	10-20 mins.
Shortbread (1 x 180mm / 7")	2	3	55 -65 mins.
Biscuits	4	1 and 3	10-20 mins.
Shortcrust Pastry	6	2	15 - 60 mins depending on use.
Rich Short Crust	5	1 and 3	20-30 mins.
Flaky/Puff Pastry	7	2	10-30 mins.
Choux Pastry	6	2	20-30mins.
<b>Yeast Mixtures</b>			
Bread - rolls	7	2 and 4	20-30 mins.
<b>Miscellaneous</b>			
Yorkshire Pudding:- large	7	1	30-40 mins
individual	7	2	20-30mins

When baking with two trays or tins on two levels, the top tray is removed first and the lower tray moved up to the top position for a few minutes longer.

Soft Margarine -

Use the oven settings recommended by the margarine manufacturer and **not** those indicated on the cooking chart.

# Using the Main Oven for Other Functions

EN

## 'S'SLOW Setting

This is used for slow cooking, keeping food warm and warming plates for short periods. Extra care should be taken when warming bone china, as it may be damaged in a hot oven.

**DO NOT place food or plates directly on the oven floor as this could** damage both the oven lining and the plates which are being warmed.

### Advantages of "SLOW" cooking are:

The oven stays cleaner because there is less splashing.  
Timing of food is not as critical, so there is less fear of overcooking.  
Inexpensive joints of meat are tenderised.  
Fully loading the oven can be economical.  
Cooking times can be extended in some cases by up to 2 hours.

### Operation:

1. Place the prepared food in the main oven and ensure the door is fully closed.
2. Select 'S' (Slow Cooking Temperature) by turning the Main Oven Control clockwise ensuring the oven door is fully closed.

### Storage and re-heating of food:

1. If food is to be frozen or not used immediately, place it in a clean container and cool as soon as possible.
2. Always thaw frozen food completely in the refrigerator before re-heating.
3. Always reheat food thoroughly and ensure it is piping hot before serving.
4. Only re-heat food once.

### Points to consider when preparing food for "SLOW" cooking:

1. Make sure that the dishes to be used will fit into the oven ensuring enough room for air to circulate.
2. All dishes cooked on the slow setting will require a minimum of 6 hours, however, **if** they are cooked for 1 -2 hours longer then deterioration in their appearance may be noticed.
3. Never cook joints of meat over 2.7kg (6 lb) or poultry over 2.0kg (4lb 8oz).  
We do not recommend that joints of meat or poultry are stuffed before cooking on the slow setting.
4. To seal in the meat juices, always cook meat or poultry at 170°C for 30 minutes before wrapping in foil and placing on a rack over a tin (to allow good air circulation) before turning the control to the slow setting and cooking immediately.
5. Always ensure that joints of pork and poultry are thoroughly cooked by checking with a meat thermometer before serving.
6. Always thaw frozen foods completely before cooking. We do not recommend placing frozen food in the oven to cook.
7. Always bring soups, liquids and casseroles to the boil before placing in the oven.
8. Ensure that casserole dishes have a good seal (not airtight) and cover to the top with foil to prevent loss of moisture.
9. Ensure that fruit and vegetables are cut into even sized small pieces to cook properly.
10. Always adjust seasoning before serving.
11. If using dried red kidney beans it is important that the beans are soaked and then boiled for a minimum of 10 minutes before using in any dish to destroy any toxins.
12. When cooking fish or egg dishes it may be necessary to check during cooking to avoid overcooking

# Care and maintenance

EN

**TURN OFF THE MAIN SWITCH AND ENSURE THE COOKER IS COLD BEFORE CLEANING. BEFORE SWITCHING ON AGAIN, ENSURE THAT ALL CONTROLS ARE IN THE OFF POSITION.**

**Do not use steam cleaning equipment.**

**Use protective gloves during all operations.**

**Carry out the required operations when the oven is cold.**

**Disconnect the appliance from the power supply.**

**Do not use wire wool, abrasive scourers or abrasive/corrosive cleaning agents, as these could damage the surfaces of the appliance.**

## EXTERIOR SURFACES

- Clean the surfaces with a damp microfibre cloth. If they are very dirty, add a few drops of pH-neutral detergent. Dry them with a dry cloth.
- Do not use corrosive or abrasive detergents. If any of these products inadvertently comes into contact with the surfaces of the appliance, clean immediately with a damp microfibre cloth.

## INTERIOR SURFACES

- After every use, leave the oven to cool and then clean it, preferably while it is still warm, to remove any deposits or stains caused by food residues. To dry any condensation that has formed as a result of cooking foods with a high water content, let the oven to cool completely and then wipe it with a cloth or sponge.
- Clean the glass in the door with a suitable liquid detergent.

## CATALYTIC PANELS (SOME MODELS ONLY)

Special catalytic panels facilitate the cleaning of the cooking compartment thanks to their special self-cleaning coating, which is highly porous and able to absorb grease and grime.

Please note: Using corrosive or abrasive cleaning agents, stiff brushes, pan scourers or oven sprays could damage the catalytic surface and compromise its self-cleaning properties.

Please contact our After-sales Service if you require replacement panels.

## REPLACING THE LIGHT

- 1. Disconnect the oven from the power supply.**
- 2. Unscrew the cover from the light, replace the bulb and screw the cover back on the light.**

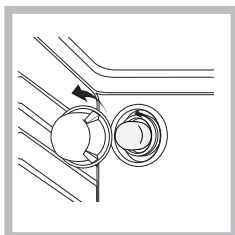

- 3. Reconnect the oven to the power supply.**

## ACCESSORIES

Soak the accessories in a washing-up liquid solution after use, handling them with oven gloves if they are still hot. Food residues can be removed using a washing-up brush or a sponge.

## INSPECTING THE OVEN SEALS

Check the door seals around the oven periodically. If the seals are damaged, please contact your nearest Authorised After-sales Service Centre. We recommend that the oven is not used until the seals have been replaced.

Note: Use 25 W/230 V type E14

The bulb used in the product is specifically designed for domestic appliances and is not suitable for general room lighting within the home (EC Regulation 244/2009).

Light bulbs are available from our After-sales Service.

- Do not handle bulbs with your bare hands as your fingerprints could damage them. Do not use the oven until the light cover has been refitted.



# Care and maintenance

## Respecting and conserving the environment

- Whenever possible, avoid pre-heating the oven and always try to fill it. Open the oven door as little as possible because heat is lost every time it is opened. To save a substantial amount of energy, simply switch off the oven 5 to 10 minutes before the end of your planned cooking time and use the heat the oven continues to generate.
- Keep gaskets clean and tidy to prevent any door energy losses
- If you have a timed tariff electricity contract, the “delay cooking” option will make it easier to save money by moving operation to cheaper time periods.
- The base of your pot or pan should cover the hot plate. If it is smaller, precious energy will be wasted and pots that boil over leave encrusted remains that can be difficult to remove.
- Cook your food in closed pots or pans with well-fitting lids and use as little water as possible. Cooking with the lid off will greatly increase energy consumption
- Use purely flat pots and pans
- If you are cooking something that takes a long time, it's worth using a pressure cooker, which is twice as fast and saves a third of the energy.

## Assistance

### Please have the following information handy:

- The appliance model (Mod.).
- The serial number (S/N).

This information can be found on the data plate located on the appliance and/or on the packaging.

## AFTER-SALES SERVICE

To receive assistance, call the number given on the warranty leaflet enclosed with the product or follow the instructions on our website. Be prepared to provide:

- a brief description of the problem;
- the exact model type of your product;
- the assistance code (the number following the word SERVICE on the identification plate attached to the product, which can be seen on the inside edge when the oven door is open);
- your full address;
- a contact telephone number.

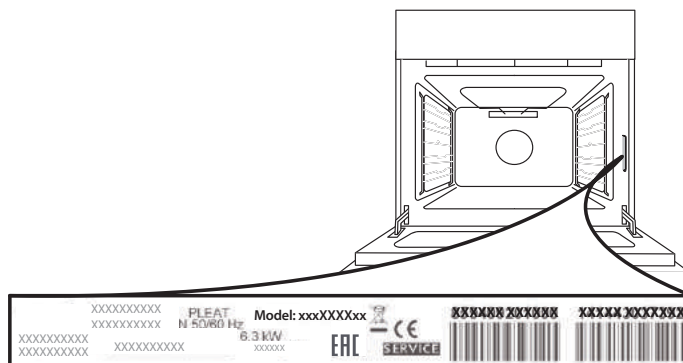

Please note: If repairs are required, contact an authorised service centre that is guaranteed to use original spare parts and perform repairs correctly.

Please refer to the enclosed warranty leaflet for more information on the warranty.

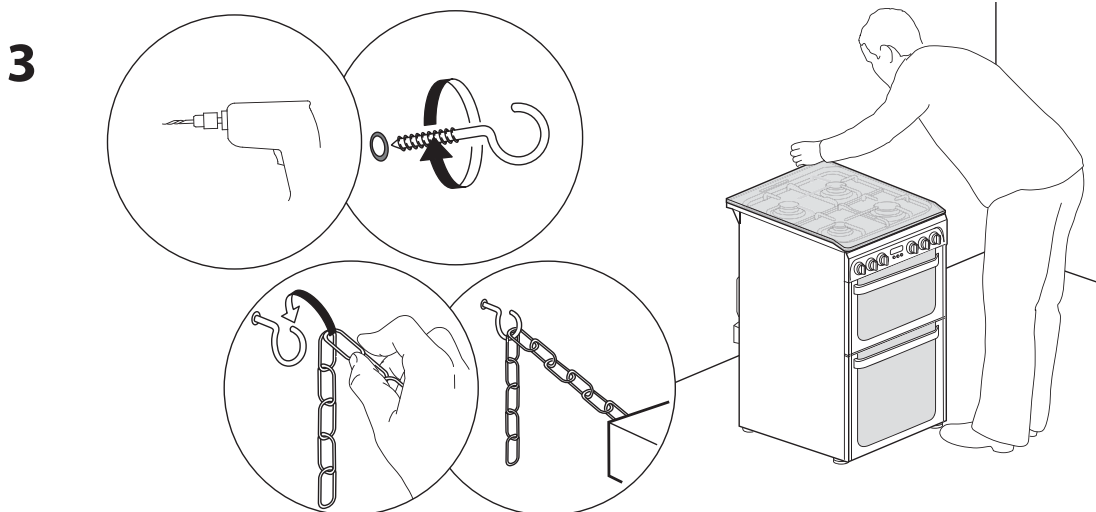
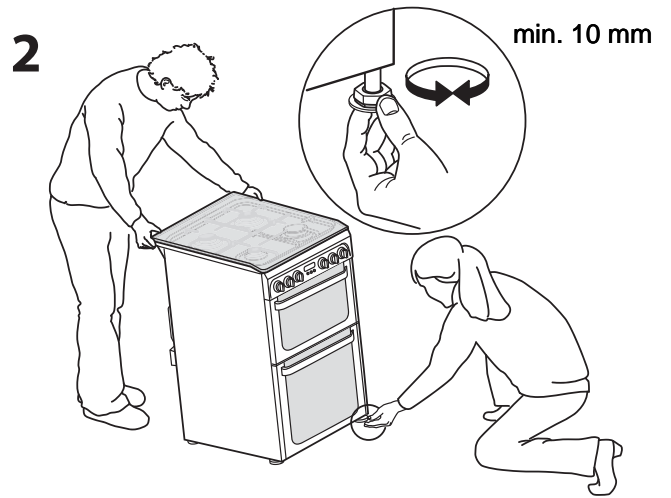
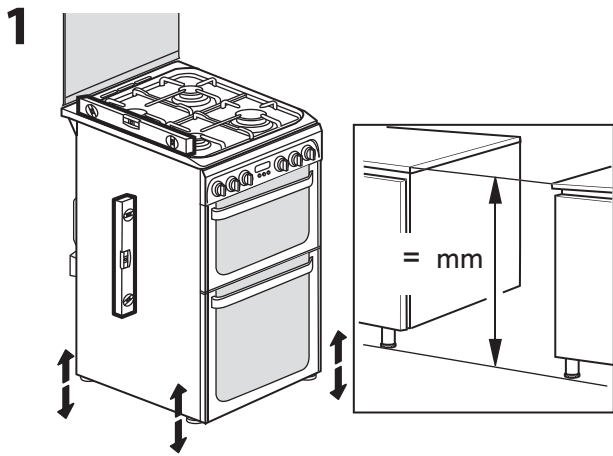
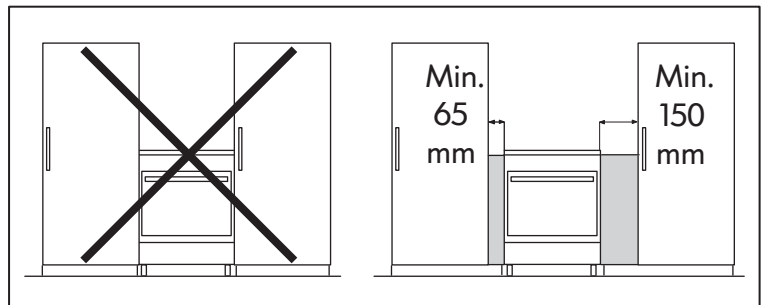
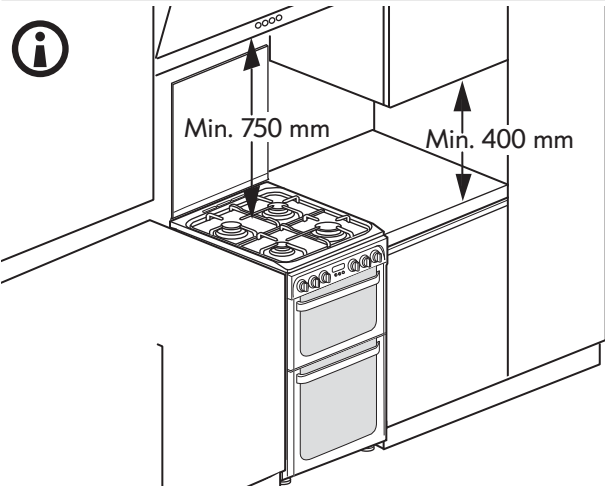
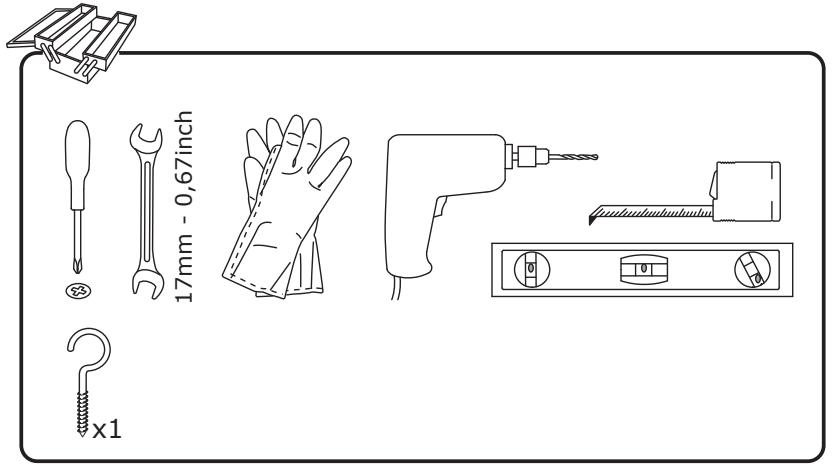
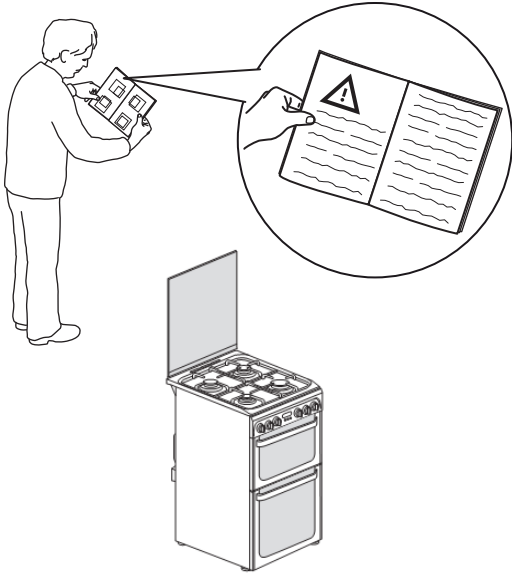

4

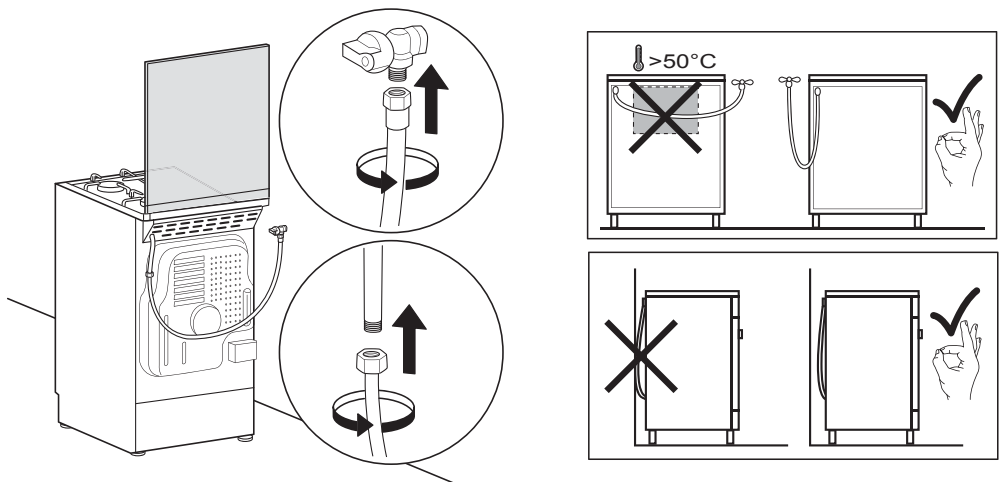

5

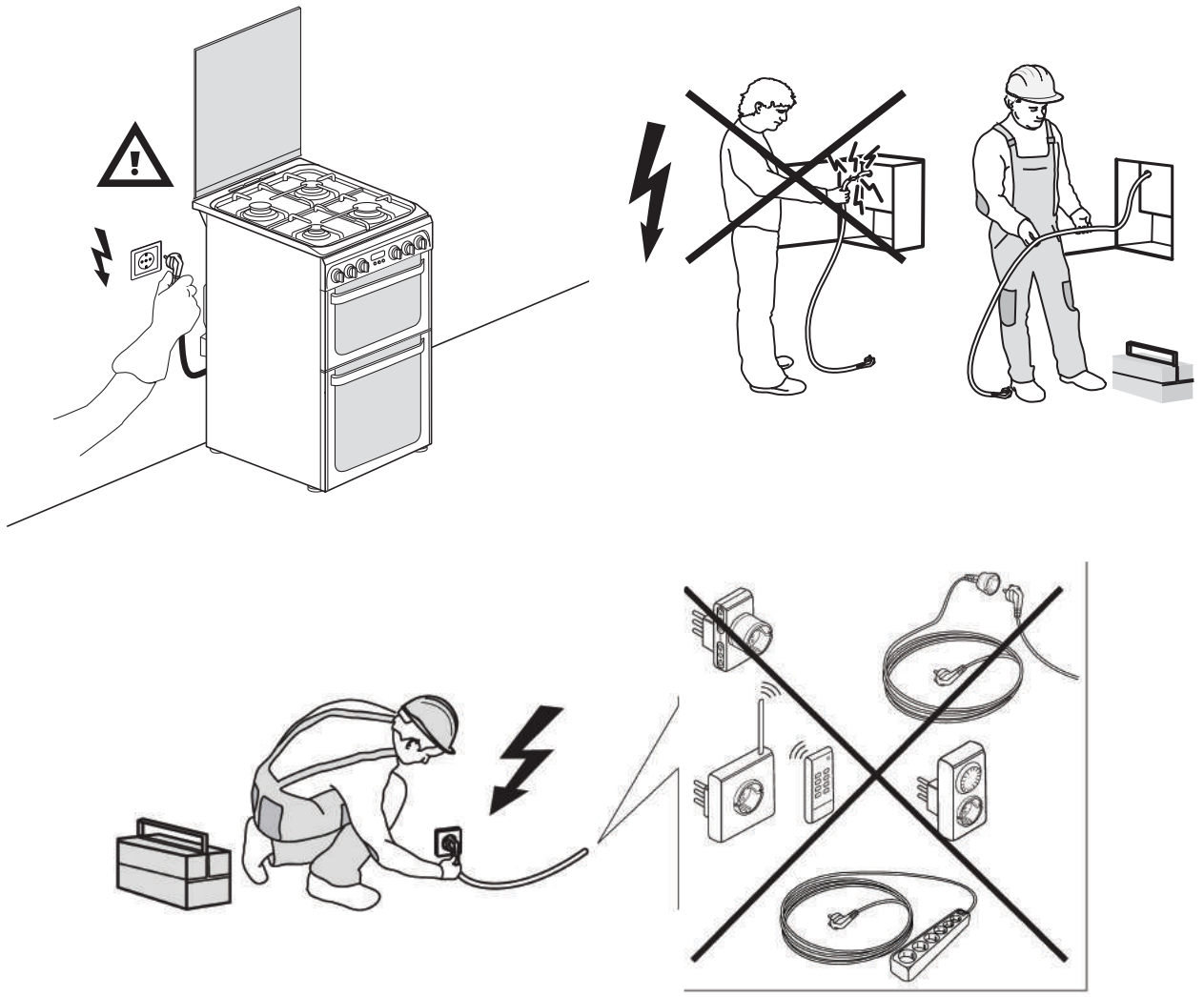

Whirlpool EMEA S.p.A.  
Via Carlo Pisacane n.1  
20016 Pero (MI), Italy  
VAT number: IT00693740425  
[www.hotpoint.co.uk](http://www.hotpoint.co.uk)



11/2018 - W11309816  
**XEROX FABRIANO**