

Hotpoint

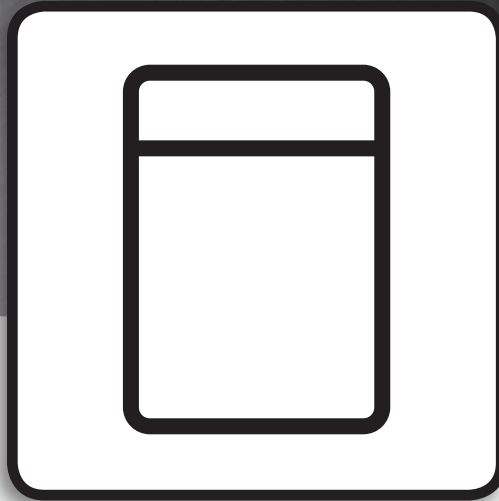

INSTRUCTION FOR USE



THANK YOU FOR PURCHASING A HOTPOINT PRODUCT.

To receive more comprehensive help and support, please register your product at:
www.hotpoint.eu/register



Before using the appliance carefully read Safety Instructions guide.

The control panel of this dishwasher activates pushing by ON/OFF button.

For energy saving the control panel deactivates automatically after 10 minutes if no cycle has started.

PRODUCT DESCRIPTION

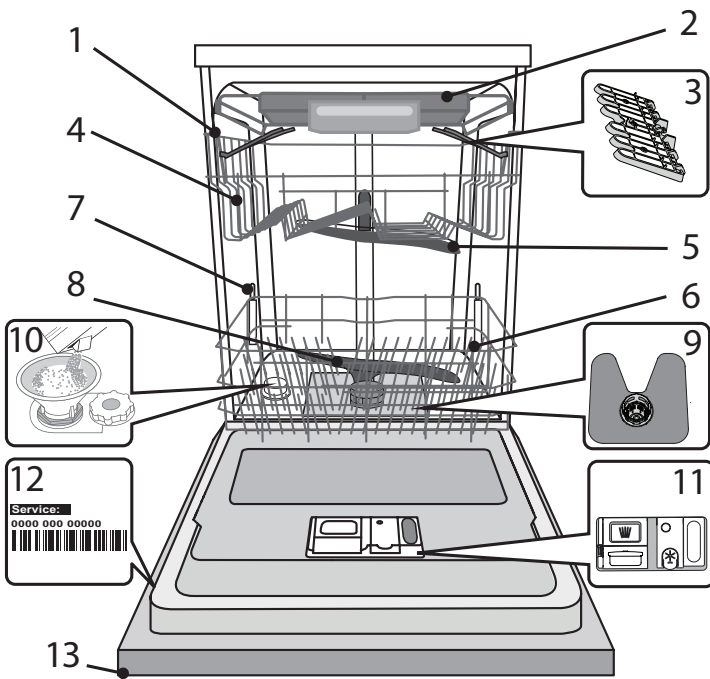

- 1. Upper rack
- 2. Cutlery rack
- 3. Foldable flaps
- 4. Upper rack height adjuster
- 5. Upper sprayer arm
- 6. Lower rack
- 7. Space Zone support
- 8. Lower sprayer arm
- 9. Filter Assembly
- 10. Salt reservoir
- 11. Detergent and Rinse Aid dispensers
- 12. Rating plate
- 13. Control panel

CONTROL PANEL

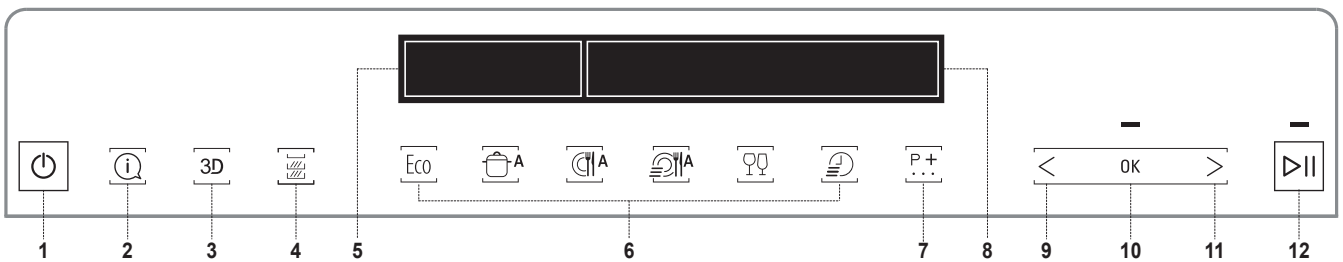

- 1. ON/OFF button
- 2. INFO button. Provide info for selected cycle
- 3. 3D ZONE WASH button
- 4. ZONE WASH button
- 5. DISPLAY - Indicators area
- 6. CYCLES 6 buttons for direct access popular cycles
- 7. EXTRA CYCLES button. Access to other cycles
- 8. DISPLAY - Information area
- 9. PREVIOUS button for options/settings
- 10. OK button. Select/change options and settings
- 11. NEXT button for options/settings
- 12. START/PAUSE button

DISPLAY - INDICATORS

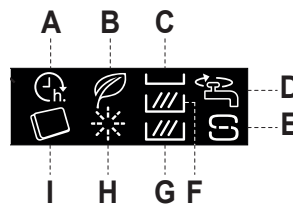

- A. START DELAY
- B. ECO CYCLE
- C. ZONE WASH - Cutlery rack
- D. CLOSED WATER TAP
- E. ADD SALT
- F. ZONE WASH - Upper Rack
- G. ZONE WASH - Lower Rack
- H. ADD RINSE AID
- I. TABLET

FIRST TIME USE

After connecting the appliance to the power supply for the first time, the display will guide you to set up the appliance for first use.

1. The language selection

LANGUAGE: ENGLISH? <> = CHANGE OK = YES	To select preferred language please press button „<” or „>”.
ENGLISH SELECTED	Confirm by pressing „OK” button.

After language confirmation, the appliance will go through the first time use configuration menu.

2. Setting the water hardness

WATER HARDNESS (1=MIN, 5=MAX)	The water hardness is by default set to level 3. To change water hardness level press button „<” or „>” repeatedly.
WATER HARDNESS = 3 <> = CHANGE OK = YES	To confirm your choice press „OK” button. The level must be set according to the table below.

To allow the water softener to work in a perfect way, it is essential that the water hardness setting is based on the actual water hardness in your house. This information can be obtained from your local water supplier.

Water Hardness Table				
Level		°dH German degrees	°fH French degrees	°Clark English degrees
1	Soft	0 - 6	0 - 10	0 - 7
2	Medium	7 - 11	11 - 20	8 - 14
3	Average	12 - 16	21 - 29	15 - 20
4	Hard	17 - 34	30 - 60	21 - 42
5	Very hard	35 - 50	61 - 90	43 - 62

3. Filling the water softener

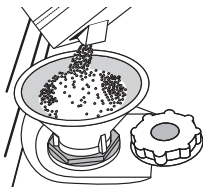
POUR WATER OPERATION	When water hardness is set, it is required to fill water softener with water and special regeneration salt.
INSERT 1,5 LITER OF OK = DONE	Remove the lower rack and unscrew the reservoir cap (anticlockwise)
WATER IN THE OK = DONE	As a first step it is needed to fill reservoir with water (~1.5 litres).
WATER SOFTENER OK = DONE	Once done, proceed to the next step by pressing „OK” button.
INSERT SALT OPERATION	
ADD 1KG OF SALT OK = DONE	
IN THE SALT DISPENSER OK = DONE	

Position the funnel (see figure) and fill the salt reservoir right up to its edge (approximately 1 kg); it is not unusual for some water will spill out. Remove the funnel and wipe any salt residue away from the opening.

Make sure the cap is screwed on tightly, so that no detergent can get into the container during the wash program (this could damage the water softener beyond repair).

Once done, proceed to the next step by pressing „OK” button.

Only use salt that has been specifically designed for dishwashers.

Whenever you need to add salt, it is mandatory to complete the procedure before the beginning of the washing cycle to avoid corrosion. Residual saline solution or grains of salt can lead to corrosion, irreparably damaging the stainless steel components. The guarantee is not applicable if faults are caused by such circumstances. If the salt container is not filled, the water softener and the heating element may be damaged as a result of limescale accumulation. Using of Salt is recommended with any type of dishwasher detergent.

4. Setting the brightness level

ADJUST BRIGHTNESS (1=MIN, 5=MAX)	The brightness level is by default set to level 5. To change brightness level press button „<” or „>” repeatedly.
BRIGHTNESS = 5 <> = CHANGE OK = YES	To confirm your choice press „OK” button.

5. Detergent type operation

DETERGENT TYPE OPERATION	In this step it is very important to choose what type of detergent will be used (tablet/capsule or gel/powder).
DO YOU USE <> = NO OK = YES	If you prefer to use All-in-one detergent in tablet or capsule for washing - press „OK”, then go to step 7. Open tap operation on the next page.
“ALL IN ONE” <> = NO OK = YES	
DETERGENT? <> = NO OK = YES	

The symbol  on display will be lit. If you prefer to use gel or powder detergent for washing, press „<” or „>”, then go to step 6. **Rinse aid operation.**

6. Rinse aid operation*

*If All-in-one detergent was chosen in the previous step, this step will be skipped by the appliance.

RINSE AID OPERATION
INSERT RINSE AID OK = DONE
IN THE DISPENSER OK = DONE

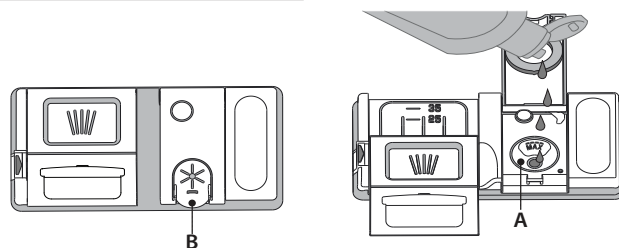

1. Open the dispenser **B** by pressing and pulling up the tab on the lid.
2. Carefully introduce the rinse aid as far as the maximum (110 ml) reference notch of the filling space **A** - avoid spilling it. If this happens, clean the spill immediately with a dry cloth.
3. Press the lid down until you hear a click to close it.
4. Confirm operation by pressing „OK” button.

NEVER pour the rinse aid directly into the tub.

Setting rinse aid level

(not necessary when using tablets/capsules)

The rinse aid dosage can be adjusted to the detergent used. The lower the setting, the less rinse aid is dispensed. The factory setting is for (5) level.

To change, follow instructions in section “SETTINGS / MENU”.

7. Open tap operation

OPEN TAP OPERATION	
OPEN THE WATER TAP	OK = DONE
WATER TAP	OK = DONE



Check water tap is open. If closed, open it then confirm by pressing „OK” button.

8. First cycle operation

FIRST CYCLE OPERATION	Before normal use of appliance it is recommended to run Intensive cycle first, to calibrate the appliance.
REMEMBER TO RUN THE INTENSIVE CYCLE WITH EMPTY BASKETS TO COMPLETE THE FIRST SET UP	Insert a detergent into dispenser chamber B (see below), then press „OK” button. Intensive cycle will be selected automatically. Press „START/PAUSE” button. This first cycle can be up to 20 minutes longer as a result of the automatic calibration process.
OK = EXIT	
OK = EXIT	
OK = EXIT	
OK = EXIT	
OK = EXIT	

After this process the appliance is ready for normal use.

ADDING A DETERGENT

Usage of detergent not designed for dishwashers may cause malfunction or damage to the appliance.

To achieve the best washing and drying results, the combined use of detergent, rinse aid liquid and refined salt is required.

We recommend using detergents that do not contain phosphates or chlorine, as these products are harmful to the environment.

Good washing results also depend on the correct amount of detergent being used.

Exceeding the stated amount does not result in a more effective wash and increases environmental pollution.

The amount can be adjusted to the soil level. In the case of normally soiled items, use approximately either 35g (powder detergent) or 35ml (liquid detergent) and additional tea spoon of detergent directly inside the tub. If tablets are used, one tablet will be enough.

If the crockery is only lightly soiled or if it has been rinsed with water before being placed in the dishwasher, reduce the amount of detergent used accordingly (minimum 25 g/ml) e.g. skip the powder/gel putted inside the tub.

To open the detergent dispenser, press button **C**. Introduce the detergent into the dry dispenser **D** only. Place the amount of detergent for pre-washing directly inside the tub.

1. When measuring out the detergent refer to the mentioned earlier information to add the proper quantity. Inside the dispenser **D** there are indications to help the detergent dosing.
2. Remove detergent residues from the edges of the dispenser and close the cover until it clicks.
3. Close the lid of the detergent dispenser by pulling it up until the closing device is secured in place.

The detergent dispenser automatically opens up at the right time according to the program.

If you are using a All-in-one detergents, we recommend that you add salt in any case, especially if the water is hard or very hard (follow the instructions given on the packaging).

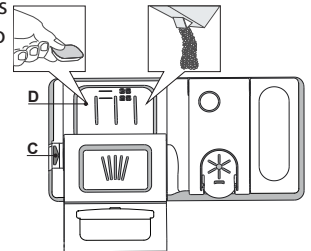

ADVICE AND TIPS

TIPS

Before loading the baskets, remove all food residues from the crockery and empty the glasses. You do not need to rinse beforehand under running water.

Arrange the crockery so that it is held in place firmly and does not tip over; and arrange the containers with the openings facing downwards and the concave/convex parts placed obliquely, thus allowing the water to reach every surface and flow freely.

Warning: lids, handles, trays and frying pans do not prevent the sprayer arms from rotating.

Place any small items in the cutlery basket.

Very soiled dishes and pans should be placed in the lower basket because in this sector the water sprays are stronger and allow a higher washing performance.

After loading the appliance, make sure that the sprayer arms can rotate freely.

UNSUITABLE CROCKERY

- Wooden crockery and cutlery.
- Delicate decorated glasses, artistic handicraft and antique crockery. Their decorations are not resistant.
- Parts in synthetic material which do not withstand high temperatures.
- Copper and tin crockery.
- Crockery soiled with ash, wax, lubricating grease or ink.

The colours of glass decorations and aluminium/silver pieces can change and fade during the washing process. Some types of glass (e.g. crystal objects) can become opaque after a number of wash cycles too.

DAMAGE TO GLASS AND CROCKERY

- Only use glasses and porcelain guaranteed by the manufacturer as dishwasher safe.
- Use a delicate detergent suitable for crockery
- Collect glasses and cutlery from the dishwasher as soon as the wash cycle is over.

TIPS ON ENERGY SAVING

- When the household dishwasher is used according to the manufacturer's instructions, **washing tableware in a dishwasher usually consumes less energy and water than hand dishwashing.**
- In order to maximize dishwasher efficiency it is recommended to **initiate the wash cycle once dishwasher is fully loaded.** Loading the household dishwasher up to the capacity indicated by the manufacturer will contribute to energy and water savings. Information on correct loading of tableware can be found in Loading chapter. In case of partial loading it is recommended to use dedicated wash options if available (Half load/ Zone Wash, Multizone), filling up only selected racks. Incorrect loading or overloading the dishwasher may increase resources usage (such as water, energy and time, as well as increase noise level), reducing cleaning and drying performance.
- Manual pre-rinsing of tableware items leads to increased water and energy consumption and is not recommended.

HYGIENE

To avoid odour and sediment which can be accumulated in the dishwasher please run a high temperature program at least once a month. Use a tea spoon of detergent and run it without the loading to clean your appliance.

LOADING THE RACKS

CUTLERY RACK

The third rack was designed to house the cutlery.

Arrange the cutlery as shown in the figure.

A separate arrangement of the cutlery makes collection easier after washing and improves washing and drying performance.

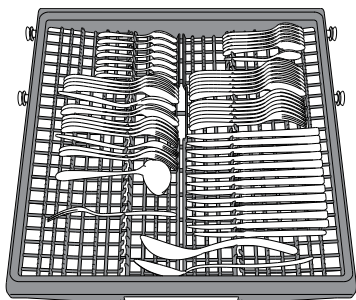

The cutlery basket is equipped with two sliding side trays to make the most of the height of the space below and enable the loading of high items into upper rack.

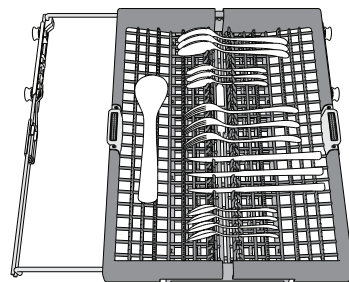

Knives and other utensils with sharp edges must be positioned with the blades facing downwards.

The geometry of the rack makes it possible to place such small items as coffee cups in the area in the middle.

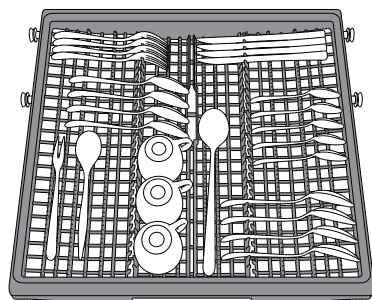

UPPER RACK

Load delicate and light dishes: glasses, cups, saucers, low salad bowls.

The upper rack has tip-up supports which can be used in a vertical position when arranging tea/ dessert saucers or in a lower position to load bowls and food containers.

(loading example for the upper rack)

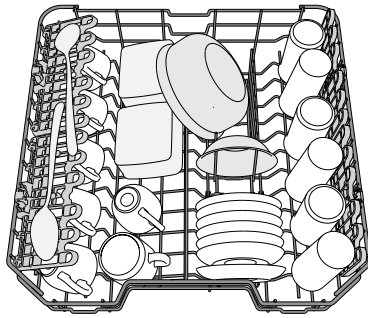

FOLDABLE FLAPS WITH ADJUSTABLE POSITION

The side foldable flaps can be fold or unfold to optimize the arrangement of crockery inside the rack. Wine glasses can be placed safely in the foldable flaps by inserting the stem of each glass into the corresponding slots.

Depending on the model:

- to unfold the flaps there is needed to slide it up and rotate or release it from the snaps and pull it down.
- to fold the flaps there is needed to rotate it and slide flaps down or pull it up and attach flaps to the snaps.

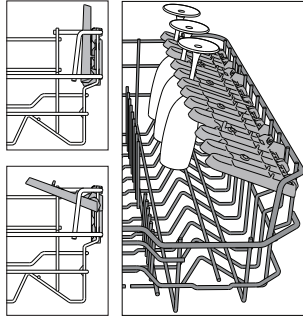

ADJUSTING THE HEIGHT OF THE UPPER RACK

The height of the upper rack can be adjusted: high position to place bulky crockery in the lower basket and low position to make the most of the tip-up supports by creating more space upwards and avoid collision with the items loaded into lower rack.

The upper rack is equipped with a **Upper Rack height adjuster** (see figure), without pressing the levers, lift it up by simply holding the rack sides, as soon as the rack is stable in its upper position.

To restore to the lower position, press the levers **A** at the sides of the rack and move the basket downwards.

We strongly recommend that you do not adjust the height of the rack when it is loaded. NEVER raise or lower the basket on one side only.

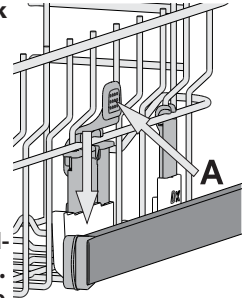

LOWER RACK

For pots, lids, plates, salad bowls, cutlery etc. Large plates and lids should ideally be placed at the sides to avoid interferences with the spray arm. The lower rack has tip-up supports which can be used in a vertical position when arranging plates or in a horizontal position (lower) to load pans and salad bowls easily.

The lower rack has a Space Zone **A** (in selected models with different numbers and positions), a special pull-out support in the rear of the rack that can be used to support frying pans or baking pans in upright position, thus taking up less space. In order to use it, just get hold of the coloured grip and pull it upwards **B** while rotating it forward. The supports can slide right and left to fit the size of the crockery.

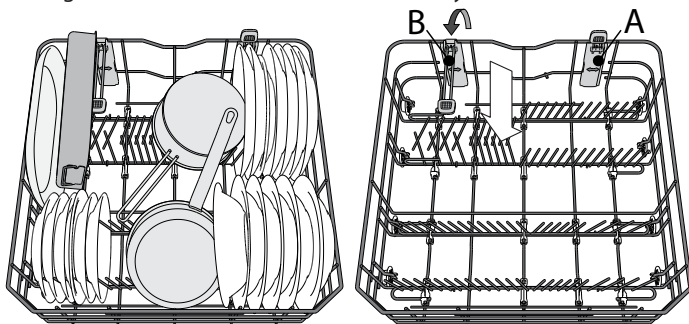

(loading example for the lower rack)

ZONE WASH 3D

Zone Wash 3D uses additional water jets located both: in the lower and upper part of the dishwasher (marked with orange color) to wash more intensively heavily soiled items by increasing water coverage on dishes. Example: Load pots and casseroles facing lower part of Zone Wash 3D components and activate the 3D Zone Wash option on the panel.

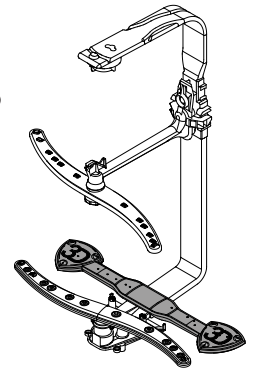

GLASS CARE

Dedicated accessory that allows you to safely store different types of stem glasses in the lower rack. It enables cleaning & drying results by allowing an optimised and stable positioning of the glasses.

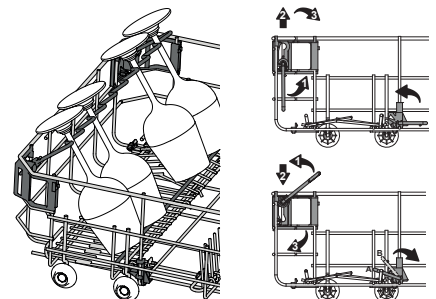

SELECTING A CYCLE AND OPTIONS



The list of available cycles and options can be found in **Cycle Table** on next page. Eco cycle is selected by default. If you want to have Last Used cycle selected by default, you can change it in „Settings Menu“.

It is possible to select a cycle by pressing 1 of 6 cycles direct access buttons or by pressing „Extra Cycles“  button repeatedly. When the last one is reached a further press goes back to the first.

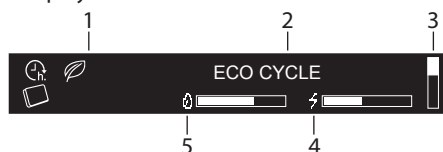
Press cycle button to choose cycle in accordance with the level of soiling of the dishes and with Cycle Table. Information will be shown on the display:



1. Indicators
2. Name of the selected cycle
3. Vertical bar showing the position of the extra cycle list only
4. Energy consumption of the selected cycle
5. Water consumption of the selected cycle



  Three seconds after selecting a cycle, its time and temperature will be displayed (if available).

Press „INFO“  button to display a brief description of the cycle and its water / energy consumption.



During the selection phase the „START/PAUSE“  LED blinks.



Additional options are available for most cycles (see „Options and Settings“ section). When any option is selected, its name is shown on the display on the right.

   If more than one option is selected one bullet point for each option is displayed. Each option name is displayed for 3 sec. with its bullet point filled.

When the cycle and option selection is complete, press „START/PAUSE“  button and close the door to start chosen cycle.

MODIFYING A RUNNING PROGRAM

If a wrong program was selected, it is possible to change it, provided that it has only just begun: press and hold the „ON/OFF“  button, the machine will switch off.

Switch the machine back on using the „ON/OFF“  button and select the new wash cycle and any desired options; start the cycle by pressing the „START/PAUSE“  button.

TO PAUSE THE CYCLE (ADDING EXTRA ITEMS)

Open the door and place the crockery inside the dishwasher, (**beware of HOT steam!**). Close the door and press „START/PAUSE“  button to resume the cycle from the point at which it was interrupted.

ACCIDENTAL INTERRUPTIONS

If the door is opened during the wash cycle, or if there is a power cut, the cycle stops. To resume the cycle from where it was interrupted, close the door and press the „START/PAUSE“  button.

During the cycle, the progress is shown on the display (as bar) as well as phase of cycle, and time to the end of the cycle with “:” blinking:



Depending at the selected cycle, the display may provide additional information:

- PRE-WASH - extra items can be added.
- WASHING - main washing.
- DRYING - drying phase of cycle.

After the cycle finishes, there is an acoustic signal and the display shows:



On the display additional information can be shown:

- ADD SALT - refill salt reservoir.
- ADD RINSE AID - refill rinse aid.
- DEGREASE AND CLEAN MACHINE WE RECOMMEND WPRO - every 50 cycle, will be recommended to use the WPRO cleaner (according to instruction on the consumable).

Open appliance door (beware of hot steam!) and unload the racks, starting from the lower rack first.

If it is needed to refill salt reservoir or rinse aid dispenser, it is recommended to do this operations right before start of the next cycle.

After 10 minutes the appliance switches off.

WATER SOFTENING SYSTEM

Water softener automatically reduces water hardness, consequently preventing scale buildup on heater, contributing also to better cleaning efficiency.







This system regenerates itself with salt, therefore it is required to refill salt container when empty.

Frequency of regeneration depends on water hardness level setting - regeneration takes place once per **6** Eco cycles with water hardness level set to **3**.

Regeneration process starts in final rinse and finishes in drying phase, before cycle ends.

- Single regeneration consumes: ~3.5L of water;
- Takes up to 5 additional minutes for the cycle;
- Consumes below 0.005kWh of energy.

CYCLES TABLE

CYCLE	Available options *	Drying phase	Active-Dry	Duration of wash cycle (h:min)**	Water consumption (l/cycle)	Energy consumption (kWh/cycle)
 ECO 50°	EXTRA DRY, TABLET, START DELAY	✓	✓	3:10	9.5	0.75
 AUTO-INTENSIVE 65°	3D ZONE WASH, ZONE WASH, TURBO, EXTRA DRY, TABLET, START DELAY	✓	✓	2:00 - 3:10	14.0 - 17.0	1.50 - 1.85
 AUTO-MIXED 55°	3D ZONE WASH, ZONE WASH, TURBO, EXTRA DRY, TABLET, START DELAY	✓	✓	1:30 - 2:30	14.5 - 16.0	1.15 - 1.30
 AUTO-FAST WASH 50°	TABLET, START DELAY	-	-	0:55 - 1:20	13.0 - 14.5	1.15 - 1.25
 DELICATES 45°	ZONE WASH, EXTRA DRY, TABLET, START DELAY	✓	✓	1:40	11.5	1.20
 EXPRESS 30' 50°	ZONE WASH, TABLET, START DELAY	-	-	0:30	9.0	0.50
EXTRA CYCLES - available by pressing  button						
GOOD NIGHT 50°	EXTRA DRY, TABLET, START DELAY	✓	✓	3:30	15.0	1.15
SANITIZING 65°	START DELAY	✓	-	1:40	10.0	1.30
SOAK cold	ZONE WASH, START DELAY	-	-	0:12	4.5	0.01
SELF CLEAN 65°	START DELAY	-	-	0:50	8.0	0.85

- ECO** - Eco programme is suitable to clean normally soiled tableware, that for this use, it is the most efficient programme in terms of its combined energy and water consumption, and that it is used to assess compliance with the EU Ecodesign legislation.
- AUTO-INTENSIVE** - Automatic program for heavily soiled dishes and pans (not to be used for delicate items).
- AUTO-MIXED** - Automatic program for normally soiled pans and dishes.
- AUTO-FAST WASH** - Automatic program for limited quantity of normally soiled crockery. Ensures optimal cleaning performance in short time.
- DELICATES** - Program for delicate items, which are more sensitive to high temperatures, for example glasses and cups.
- EXPRESS 30'** - Program to be used for half load of lightly-soiled dishes with no dried food residues. Does not include drying phase.

EXTRA CYCLES

- GOOD NIGHT** - Suitable for night-time operation of the appliance. Ensures optimal cleaning and drying performance with the lowest noise emission.
- SANITIZING** - Normally or heavily soiled crockery, with additional antibacterial wash. Can be used to perform maintenance of the dishwasher.
- SOAK** - Use to refresh crockery planned to be washed later. No detergent to be used with this program.
- SELF CLEAN** - Program to be used to perform maintenance of the dishwasher, to be carried out only when the dishwasher is EMPTY using specific detergents designed for dishwasher maintenance.

Notes:

Please note that cycle *EXPRESS 30'* is dedicated for lightly soiled dishes.

ECO program data is measured under laboratory conditions according to European Standard EN 60436:2019. Note for Test Laboratories: For information on comparative EN testing conditions, please send an email to the following address: assistenza_en_lvs@indesitcompany.com

Pre-treatment of the dishes is not needed before any of the programs.

* Not all options can be used simultaneously.

** Values given for programs other than the program *Eco* are indicative only. The actual time may vary depending on many factors such as temperature and pressure of the incoming water, room temperature, amount of detergent, quantity and type of load, load balancing, additional selected options and sensor calibration. The sensor calibration can increase program duration up to 20 min.

OPTIONS AND SETTINGS

With each cycle additional options can be used. A full list of available options working with specific cycles can be found in the **Cycle Table** on the previous page. All active options are shown on the display.

To set an option press „OK” button. SET OPTIONS message is shown for a few seconds. Then use „<” or „>” button to navigate through the option list. Press „OK” to select the option, in the setting menu the LED above „OK” button is lit.

If the option is not available, it will be still visible in its position but with „☒”

3D ZONE WASH

Option works with one rack at once. In particular, we recommend to use it with Mixed and Intensive cycles - thanks to the additional 3D water jets placed on the bottom of the cavity, ZONE WASH 3D option allows to save energy or to increase the washing performance of the dishwasher:

- 3D ZONE WASH + MIXED CYCLE: it allows to reduce energy consumption up to 40%.
- 3D ZONE WASH + INTENSIVE CYCLE: it increases the washing performances up to 40%. Ideal for very soiled mixed loads, e.g. pans and saucepans, dishes with heavy encrustation or difficult-to-clean crockery (grater, vegetable mill, dirty cutlery).

How to activate the option:

1. Select a compatible cycle (Normal or Intensive).
2. Press 3D button to activate/deactivate the option: a basket icon will blink for a few seconds.



3. It is possible to change the selected rack pressing the ZONE WASH button.
4. Remember to load the crockery in the selected rack only.

ZONE WASH

If there are not many dishes to be washed it can be loaded in one rack only. Using this option you can select which rack you want to wash. Select a compatible cycle (see “Cycles table”), and then press the ZONE WASH button: the symbol of the chosen rack will appear on the display.

By default the ZONE WASH is not active and all racks icons are lit.

- Selected only lower rack.
- Selected only upper rack.
- Selected only cutlery rack.

TABLET (All-in-one)

This setting allows you to optimise the performance of the cycle according to the type of detergent used. Enable it if you use combined detergents in tablet form (rinse aid, salt and detergent in 1 dose).

TABLET	OFF
TABLET	ON
TABLET	ON

To set the Tablet, enter in the setting menu by pressing „OK” button and navigate with „< , >” until „TABLET” is shown, then press „OK” button.

START DELAY

The start of the cycle may be delayed for a selected period of time.

To set a delay, enter in the setting menu by pressing „OK” button and navigate with „< , >” until „START DELAY” is shown, then press „OK” button.

With each press of the button „>” or „<”, the delay start increases by:

- every 0:30 if selection below 4 hours,
- every 1:00 if selection is below 12 hours,
- every 2 hours if selection is above 12 hours.

START DELAY	OFF
<STARTS IN h>	OFF
<STARTS IN h>	4:00
<STARTS IN h>	4:00

Default value is OFF.

If delay is selected, the is lit.

Once „OK” button is pressed the delay is confirmed and the machine comes back to the cycle selection screen with delay value visible.

Press „START/PAUSE” button and close the door within 4 sec. to start the delay.

To remove the delay, press „<” or „>” button until „OFF” is displayed.

TURBO

This option can be used to reduce the duration of the main cycles while maintaining washing and drying performance levels.

TURBO	OFF
TURBO	ON
TURBO	ON

To set the Turbo, enter in the setting menu by pressing „OK” button and navigate with „< , >” until „TURBO” is shown, then press „OK” button.

With each press of the button „>” or „<” option will be ON or OFF. Confirm by pressing „OK” button.

EXTRA DRY

This option allows to improve the drying of the dishes using higher temperature during the final rinse and an extended drying phase. The EXTRA DRY option results in the lengthening of the wash cycle.

EXTRA DRY	OFF
EXTRA DRY	ON
EXTRA DRY	ON

To set the Extra Dry, enter in the setting menu by pressing „OK” button and navigate with „< , >” until „EXTRA DRY” is shown, then press „OK” button.

With each press of the button „>” or „<” option will be ON or OFF. Confirm by pressing „OK” button.

KEYLOCK

KEYLOCK ACTIVATED PRESS "OK" FOR 3 SEC.
KEEP PRESSED...
KEYLOCK DEACTIVATED

The KEYLOCK function blocks the control panel except the „ON/OFF” button.

To activate the Keylock, enter in the setting menu by pressing „OK” button and navigate with „< or >” until „KEYLOCK” is shown, then press OK.

Once set, to deactivate it keep pressing „OK” button for a few seconds.

SETTINGS MENU

To change machine settings you need to enter into the Settings Menu.

Press „OK” button and navigate with „<, >” until **SETTINGS** is shown, then press „OK” button.

To exit the setting menu, press any cycle button or press „<, >” button until **EXIT** is shown, then press „OK” button.

Language

1.LANGUAGE	OK	To change language, enter in the setting menu by pressing „OK” button and navigate with „<, >” until „LANGUAGE” is shown, then press „OK” button.
1.ITALIANO	< >	
1.ENGLISH		

First cycle

2.FIRST CYCLE	OK	You can choose which cycle is selected by default when switching on the appliance: <i>ECO</i> or the <i>LAST USED</i> one.
2.<ECO>	< >	
2.<LAST USED>		To change first cycle, enter in the setting menu by pressing „OK” button and navigate with „<, >” until „FIRST CYCLE” is shown, then press „OK” button.

Sounds

3.SOUNDS	OK	To change sounds, enter in the setting menu by pressing „OK” button and navigate with „<, >” until „SOUNDS” is shown, then press „OK” button.
3.<HIGHT>	< >	
3.<OFF>		Choose between 2 levels: <i>High</i> ; <i>Low</i> . Can be also <i>OFF</i> .

Water Hardness

4.WATER HARDNESS	3	To change water hardness level, enter in the setting menu by pressing „OK” button and navigate with „<, >” until „WATER HARDNESS” is shown, then press „OK” button.
4.WATER HARDNESS	4	

To setup correct level according to water hardness, see table on page 4.

Screen Brightness

5.SCREEN BRIGHT.	5	To change screen brightness level, enter in the setting menu by pressing „OK” button and navigate with „<, >” until „SCREEN BRIGHT.” is shown, then press „OK” button.
5.SCREEN BRIGHT.	3	

Choose between five levels: 1, 2, 3, 4 and 5.

ActiveDry

ActiveDry is a convection drying system which automatically opens the door during/after drying phase to ensure exceptional drying performance every day. Door opens at the temperature that is safe to your kitchen furniture, thus door will not be opened when the option of SANI RINSE or TURBO are on.

As additional steam protection, special designed protection foil is added together with the dishwasher (depending on the model type - can be the need to buy it). To see how to mount protection foil please refer to (INSTALLATION GUIDE).

ActivEco functionality could be disabled by the user as follows:

6.ACTIVEDRY	ON	To set ActiveDry on or off, enter in the setting menu by pressing „OK” button and navigate with „<, >” until „ACTIVEDRY” is shown, then press „OK” button.
6.ACTIVEDRY	OFF	

Rinse Aid level

7.RINSE AID LEV.	5	To change rinse aid level, enter in the setting menu by pressing „OK” button and navigate with „<, >” until „RINSE AID LEV.” is shown, then press „OK” button.
7.RINSE AID LEV.	4	

Choose between five levels: 1, 2, 3, 4 and 5.

If the rinse aid level is set to 1, no rinse aid will be supplied. The LOW RINSE AID indicator light will not be lit if you run out of rinse aid.

The factory setting is for (5) level .

- If you see bluish streaks on the dishes, set a low number (2-3).
- If there are drops of water or limescale marks on the dishes, set a high number (4-5).

Demo mode

8.DEMO MODE	ON	To see the demo mode, enter in the setting menu by pressing „OK” button and navigate with „<, >” until „DEMO MODE” is shown, then press „OK” button.
8.DEMO MODE	OFF	

Reset to factory default

9.RESET TO DEF.	OK	To reset to factory default, enter in the setting menu by pressing „OK” button and navigate with „<, >” until „RESET TO DEF.” is shown, then press „OK” button.
9.ON	< >	
9.OFF		

Exit

10.EXIT	OK	To exit the setting menu, press any cycle button or press „<, >” button until EXIT is shown, then press „OK” button.
---------	----	---

CARE AND MAINTENANCE

ATTENTION: Always unplug the appliance when cleaning it and when performing maintenance work. Do not use flammable liquids to clean the machine.

CLEANING THE DISHWASHER

Any marks on the inside of the appliance may be removed using a cloth dampened with water and a little vinegar.

The external surfaces of the machine and the control panel can be cleaned using a non-abrasive cloth which has been dampened with water. Do not use solvents or abrasive products.



PREVENTING UNPLEASANT ODOURS

Always keep the door of the appliance ajar in order to avoid moisture from forming and being trapped inside the machine. Clean the seals around the door and detergent dispensers regularly using a damp sponge. This will avoid food becoming trapped in the seals, which is the main cause behind the formation of unpleasant odours.

CHEKING THE WATER SUPPLY HOSE

Check the inlet hose regularly for brittleness and cracks. If damaged, replace it by a new hose available through our After-Sales Service or your specialist dealer. Depending on the hose type:

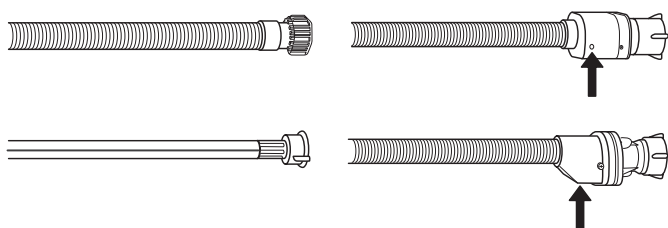

If the inlet hose has a transparent coating, periodically check if the colour intensifies locally. If yes, the hose may have a leak and should be replaced.

For water stop hoses: check the small safety valve inspection window (see arrow). If it is red, the water stop function was triggered, and the hose must be replaced by a new one.

For unscrewing this hose, press the release button while unscrewing the hose.

CLEANING THE WATER INLET HOSE

If the water hoses are new or have not been used for an extended period of time, let the water run to make sure it is clear and free of impurities before performing the necessary connections. If this precaution is not taken, the water inlet could become blocked and damage the dishwasher.

CLEANING THE FILTER ASSEMBLY

Regularly clean the filter assembly so that the filters do not clog and that the waste water flows away correctly.

Using dishwasher with clogged filters or foreign objects inside filtration system or sprayarms may cause unit malfunction resulting in lose of performance, noisy work or higher resources usage.

The filter assembly consists of three filters which remove food residues from the washing water and then recirculate the water.

The dishwasher must not be used without filters or if the filter is loose.

At least once per month or after each 30 cycles, check the filter assembly and if necessary clean it thoroughly under running water, using a non-metallic brush and following the instructions below:

1. Turn the cylindrical filter **A** in an anti-clockwise direction and pull it out (Fig 1).
2. Remove the cup filter **B** by exerting a slight pressure on the side flaps (Fig 2).
3. Slide out the stainless-steel plate filter **C** (Fig 3).
4. In case you find foreign objects (such as broken glass, porcelain, bones, fruit seeds etc.) **please remove them carefully**.
5. Inspect the trap and remove any food residues. **NEVER REMOVE** the wash-cycle pump protection (black detail) (Fig 4).

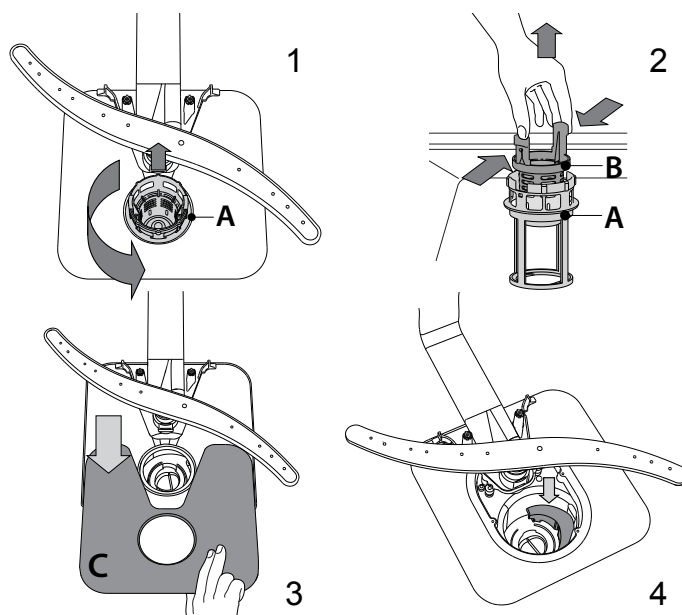

After cleaning the filters, re-place the filter assembly and fix it in position correctly; this is essential for maintaining the efficient operation of the dishwasher.

CLEANING THE SPRAY ARMS

On occasions, food residue may become encrusted onto the spray arms and block the holes used to spray the water. It is therefore recommended that you check the arms from time to time and clean them with a small non-metallic brush.

To remove the upper spray arm, turn the plastic locking ring in an anti-clockwise direction. The upper spray arm should be replaced so that the side with the greater number of holes is facing upwards.

The lower spray arm may be removed by pulling it upwards.

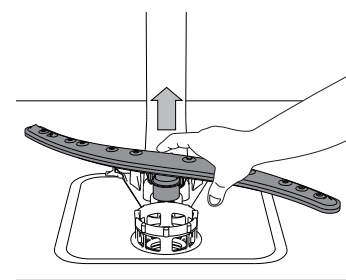
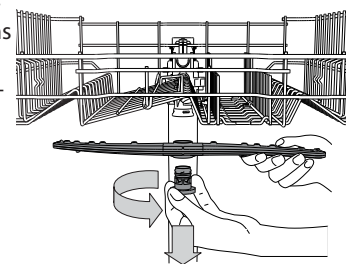

INSTALLATION

ATTENTION: If the appliance must be moved at any time, keep it in an upright position; if absolutely necessary, it may be tilted onto its back.

CONNECTING THE WATER SUPPLY

Adaptation of the water supply for installation should only be performed by a qualified technician.

The water inlet and outlet hoses may be positioned towards the right or the left in order to achieve the best possible installation.

Make sure the dishwasher does not bend or squash the hoses.

CONNECTING THE WATER INLET HOSE

- Run the water until it is perfectly clear.
- Screw the inlet hose tightly into position and turn on the tap.

If the inlet hose is not long enough, contact a specialist store or an authorised technician.

The water pressure must be within the values indicated in the Technical Data table - otherwise the dishwasher may not function properly.

Make sure the hose is not bent or compressed.

SPECIFICATIONS FOR THE CONNECTION OF THE WATER SUPPLY HOSE:

WATER SUPPLY	cold or hot (max. 60°C)
WATER INTAKE	3/4"
POWER OF WATER PRESSURE	0,05 ÷ 1 MPa (0.5 ÷ 10 bar) 7,25 – 145 psi

CONNECTING THE WATER OUTLET HOSE

Connect the outlet hose to a drain duct with a minimum diameter of 2 cm **A**.

The outlet hose connection must be at a height ranging from 40 to 80 cm from the floor or surface where the dishwasher rests.

Before connecting the water outlet hose to the sink drain, remove the plastic plug **B**.

ANTI-FLOODING PROTECTION

Anti-flooding protection. To ensure floods do not occur, the dishwasher:

- is provided with a special system which blocks the water supply in the event of anomalies or leaks from inside the appliance.

Some models are also equipped with the supplementary safety device **New Aqua Stop**, which guarantees anti-flooding protection even in the event of a supply hose rupture.

Under no circumstances should the water inlet hose be cut as it contains live electrical parts.

ELECTRICAL CONNECTION

⚡ WARNING: Under no circumstances should the water inlet hose be cut as it contains live electrical parts.

Before inserting the plug into the electrical socket, make sure that:

- The socket is **earth** \equiv and complies with current regulations;
- The socket can withstand the maximum load of the appliance as shown on the data plate located on the inside of the door (see *PRODUCT DESCRIPTION*).
- The power supply voltage falls within the values indicated on the data plate on the inside of the door.
- The socket is compatible with the plug of the appliance.

If this is not the case, ask an authorised technician to replace the plug (see *AFTER-SALES SERVICE*). Do not use extension cables or multiple sockets. Once the appliance has been installed, the power supply cable and the electrical socket should be easily accessible.

The cable should not be bent or compressed.

If the power supply cable is damaged, have it replaced by the manufacturer or its authorised Technical Assistance Service in order to prevent all potential hazards.

The Company shall not be held responsible for any incidents, if these regulations are not observed.

POSITIONING AND LEVELLING

1. Position the dishwasher on a level sturdy floor. If the floor is uneven, the front feet of the appliance may be adjusted until it reaches a horizontal position. If the appliance is levelled correctly, it will be more stable and much less likely to move or cause vibrations and noise while it is operating.
2. Before recessing the dishwasher, stick the adhesive transparent strip under the wooden shelf in order to protect it from any condensation which may form.
3. Place the dishwasher so that its sides or back panel are in contact with the adjacent cabinets or the wall. This appliance can also be recessed under a single worktop.
4. To adjust the height of the rear foot, turn the red hexagonal bushing on the lower central part at the front of the dishwasher using a hexagonal spanner with an opening of 8 mm. Turn the spanner in a clockwise direction to increase the height and in an anticlockwise direction to decrease it.

DIMENSIONS AND CAPACITY:

WIDTH	600 mm
HEIGHT	850 mm
DEPTH	600 mm
CAPACITY	14 standard place-settings

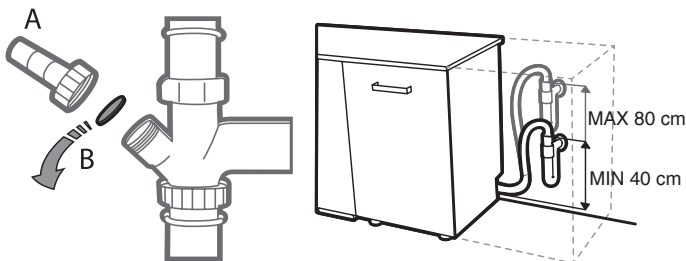

TROUBLESHOOTING

In case your dishwasher doesn't work properly, check if the problem can be solved by going through the following list. For other errors or issues please contact authorized After-sales Service which contact details can be found in the warranty booklet. The manufacturer ensures the availability of spare parts for at least 10 years after production date of this appliance.

PROBLEMS	POSSIBLE CAUSES	SOLUTIONS
Display shows: CHECK SALT! or ADD SALT	Salt reservoir is empty.	Refill reservoir with salt (see page 4). Adjust water hardness (see page 4).
Display shows: CHECK RINSE AID! or ADD RINSE AID	Rinse aid dispenser is empty.	Refill dispenser with rinse aid (see page 4).
... is not working / will not start.	The appliance must be switched on.	Check the household circuit fuse if there is no power supply.
	The appliance door doesn't close.	Check if the appliance door is closed.
	"Start Delay" option is ON.	Check whether the „Start Delay“ option has been selected. If it has, the appliance will start once the set time has elapsed. If necessary, Reset the current cycle by switching OFF the dishwasher, then switch it on again, select a new cycle, press START and close the door.
Display shows: F6  symbol on the display indicators	Water pressure is too low.	The water tap must be fully open during water inlet (minimum capacity: 0.5 litres per minute).
	Kinked water inlet hose or clogged inlet filters.	The water inlet hose must not be kinked and the inlet filter in the water tap connector must not be dirty or clogged.
Display shows: F3	Dirty filters.	Clean the filters.
	Kinked drain hose.	The drain hose must not be kinked.
	Syphon hose connection closed.	The closure disk of the syphon hose connection must be removed.
Display shows: F2	Dirty filters or spray arms.	Clean filters and spray arms.
	Too little water in the appliance system.	Concave items (e.g. bowls, cups) must be arranged facing downwards in the rack.
	Drain hose incorrectly fitted.	The drain hose must be fitted correctly (for high mounted appliances, leave min. 200 - 400mm from the lower edge of the appliance) - see Installation.
	High level of foam inside.	Repeat without detergent or wait until foam disappears..
	Water pressure is too low.	The water tap must be fully open during water inlet (minimum capacity: 0.5 litres per minute).
	Kinked water inlet hose or clogged inlet filters.	The water inlet hose must not be kinked and the inlet filter in the water tap connector must not be dirty or clogged.
Display shows: PRESS START AND CLOSE THE DOOR	Door is not closed within 4 seconds of button press.	Press again and close the appliance door within 4 seconds.
Display shows: OPEN AND CLOSE THE DOOR	The door was not open between cycles.	Unload appliance (if not unloaded before), open and close the door.
Display shows: Fx	Appliance has technical defect.	Call customer service (state fault displayed). Close the water tap.

TROUBLESHOOTING

PROBLEMS	POSSIBLE CAUSES	SOLUTIONS
The door doesn't lock.	Racks are not fit to the end.	Verify that racks are fit to the end.
	The door is not lock.	Vigorously push the door until you hear the "clack" sound.
The dishwasher makes excessive noise.	The dishes are rattling against each.	Arrange the crockery correctly (see <i>Loading the Racks</i>).
	An excessive amount of foam has been produced.	The detergent has not been measured out correctly or it is not suitable for use in dishwashers (see <i>Filling the Detergent Dispenser</i>). Reset the current cycle by switching OFF the dishwasher, then switch it on again, select a new program, press START and close the door. Please do not add any detergent.
The dishes have not been dried.	The selected program hasn't any drying phase.	Verify on the programs table if the selected program has the drying phase.
	The rinse aid has run out or the resolution is not adequate.	Add the rinse aid or adjust the dosage levels higher (see <i>Filling the Rinse Aid Dispenser</i>).
	The dishes are made of non-stick or plastic.	It is normal the presence of drops of water (see <i>Tips</i>).
The dishes are not clean.	The crockery has not been arranged properly.	Arrange the crockery correctly (see <i>Loading the Racks</i>).
	The spray arms cannot rotate freely, being hindered by the dishes.	Arrange the crockery correctly (see <i>Loading the Racks</i>).
	The wash cycle is too gentle and/or detergent efficiency is low.	Select an appropriate wash cycle (see <i>Programs Table</i>).
	An excessive amount of foam has been produced (see <i>AFTER-SALES SERVICE</i>).	The detergent has not been measured out correctly or it is not suitable for use in dishwashers (see <i>Filling the Detergent Dispenser</i>). Reset the current cycle by switching OFF the dishwasher, then switch it on again, select a new program, press START and close the door. Please do not add any detergent.
	The cap on the rinse aid compartment has not been shut correctly.	Make sure the cap of the rinse aid dispenser is closed.
	The filter is soiled or clogged.	Clean the filter assembly (see <i>Care and Maintenance</i>).
	There is no salt.	Fill the salt reservoir (see <i>Filling the Salt Reservoir</i>).
The dishes and glasses show calcination or a whitish film.	The salt level is too low.	Fill the salt reservoir (see <i>Filling the Salt Reservoir</i>).
	The adjustment of the water hardness is not adequate.	Increase the values (see <i>Water Hardness Table</i>).
	The cap of the salt reservoir is not properly closed.	Check to have properly closed the salt reservoir cap.
	The rinse aid is used up or the dosage is insufficient.	Add the rinse aid or adjust the dosage levels higher.
The dishes and glasses are blue streaked or have a bluish tinge.	The rinse aid dosage is excessive.	Adjust the dosage rates below.

You can download the Safety Instructions, Product Fiche and Energy data by:



- Visiting our website: docs.hotpoint.eu
- Using QR Code
- Alternatively, **contact our After-sales Service** (See phone number in the warranty booklet). When contacting our After-sales Service, please state the codes provided on your product's identification plate.

The model information can be retrieved using the QR-Code reported in the energy label. The label also includes the model identifier that can be used to consult the portal of the registry at <https://eprel.ec.europa.eu> (available only on certain models).

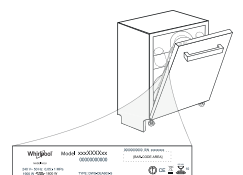

400011448992
03/2020 as - Xerox Fabriano

