

Blomberg

Double Oven User Manual

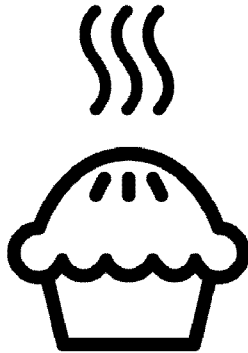

HIN651N

EN

285.3060.51/R.AA/22.08.2022

7727786389



RECYCLED &
RECYCLABLE PAPER

Please read these instructions first before using your appliance

Dear Customer,

Thank you for purchasing this Blomberg product. We hope that you get the best results from your product which has been manufactured with high quality and state-of-the-art technology. Therefore, please read this entire user manual and all other accompanying documents carefully before using the product and keep it as a reference for future use. If you handover the product to someone else, give the user manual as well. Follow all warnings and information in the user manual. Remember that this user manual is also applicable for several other models. Differences between models will be identified in the manual.

Explanation of symbols used throughout this User Manual

Explanation of symbols

Throughout this user manual the following symbols are used:



Important information or useful hints about usage.



Warning of hazardous situations with regard to life and property.



Warning of electric shock.



Warning of risk of fire.



Warning of hot surfaces.

TABLE OF CONTENTS

1 Important instructions and warnings for safety and environment 4

General safety	4
Electrical safety	5
Product safety	6
Intended use	9
Safety for children	10
Disposing of the old product	10
Package information	11

2 General information 12

Overview	12
Package contents	13
Technical specifications	14

3 Installation 15

Before installation	15
Installation and connection	16
Future Transportation	18

4 Preparation 19

Tips for saving energy	19
Initial use	19
Time setting	19
First cleaning of the appliance	20
Initial heating	20

5 How to use the hob 21

General information on hob usage	21
Control panel	23

6 How to operate the oven 29

General information on baking, roasting and grilling	29
How to operate the electric oven	30
Using the oven clock	30
Cooking times table	33
How to operate the top oven	35
Cooking times table	35
How to operate the top grill	36
Top oven cooking times table for grilling	36

7 Maintenance and care 37

General information	37
Cleaning the hob	37
Cleaning the control panel	38
Cleaning the oven	38
Cleaning the oven door	39
Removing the door inner glass	40
Replacing the oven lamp	40

8 Troubleshooting 42

9 Guarantee Details 45

1 Important instructions and warnings for safety and environment

This section contains safety instructions that will help protect from risk of personal injury or property damage. Failure to follow these instructions shall void any warranty.

General safety

- This appliance can be used by children aged from 8 years and above and persons with reduced physical, sensory or mental capabilities or lack of experience and knowledge if they have been given supervision or instruction concerning use of the appliance in a safe way and understand the hazards involved.

Children shall not play with the appliance. Cleaning and user maintenance shall not be made by children without supervision.

- The appliance is not to be used by persons (including children) with reduced physical, sensory or mental capabilities, or lack of

experience and knowledge, unless they have been given supervision or instruction. Children should be supervised and ensure they do not play with the appliance

- If the product is handed over to someone else for personal use or second-hand use purposes, the user manual, product labels and other relevant documents and parts should be also given.
- Never place the product on a carpet-covered floor. Otherwise, lack of airflow beneath the product will cause electrical parts to overheat. This will cause problems with your product.
- Installation and repair procedures must always be performed by Authorised Service Agents. The manufacturer shall not be held responsible for damages arising from procedures carried out by unauthorised persons which may also void the warranty.

Before installation, read the instructions carefully.

- Do not operate the product if it is defective or has any visible damage.
- Ensure that the product function knobs are switched off after every use.

Electrical safety

- If the product has a failure, it should not be operated unless it is repaired by an Authorised Service Agent. There is the risk of electric shock!
 - Only connect the product to a grounded outlet/line with the voltage and protection as specified in the “Technical specifications”. Have the grounding installation made by a qualified electrician while using the product with or without a transformer. Our company shall not be liable for any problems arising due to the product not being earthed in accordance with the local regulations.
 - Never wash the product by spreading or pouring water onto it! There is the risk of electric shock!
- The product must be disconnected during installation, maintenance, cleaning and repairing procedures.
 - If the power connection cable for the product is damaged, it must be replaced by the manufacturer, its service agent or similarly qualified persons in order to avoid a hazard.
 - Only use the connection cable specified in the “Technical specifications”.
 - The appliance must be installed so that it can be completely disconnected from the mains supply. The separation must be provided by a switch built into the fixed electrical installation, according to construction regulations.
 - Rear surface of the oven gets hot when it is in use. Make sure that the electrical connection does not contact with the rear surface; otherwise, connections can get damaged.
 - Do not trap the mains cable between the oven door and

frame and do not route it over hot surfaces. Otherwise, cable insulation may melt and cause fire as a result of short circuit.

- Any work on electrical equipment and systems should only be carried out by authorised and qualified persons.
- In case of any damage, switch off the product and disconnect it from the mains. To do this, turn off appropriate switch in the consumer unit in your home.
- Make sure that fuse rating is compatible with the product.

Product safety

- **WARNING:** The appliance and its accessible parts become hot during use. Care should be taken to avoid touching heating elements. Children less than 8 years of age shall be kept away unless continuously supervised.
- Never use the product when your judgment or coordination is impaired by the use of alcohol and/or drugs.

- Be careful when using alcoholic drinks in your dishes. Alcohol evaporates at high temperatures and may cause fire since it can ignite when it comes into contact with hot surfaces.
- Food Poisoning Hazard: Do not let food sit in oven for more than 1 hour before or after cooking. Doing so can result in food poisoning or sickness.
- Do not place any flammable materials close to the product as the sides may become hot during use.
- During use the appliances becomes hot. Care should be taken to avoid touching heating elements inside the oven.
- Keep all ventilation slots clear of obstructions.
- Do not heat closed tins and glass jars in the oven. The pressure that would build-up in the tin/jar may cause it to burst.
- Do not place baking trays, dishes or aluminium foil directly onto the bottom of the oven. The heat

accumulation might damage the bottom of the oven.

- Don't line the grill pan with aluminium foil, as this could result in an increase risk of fire or damage to your cooker.
- Do not use harsh abrasive cleaners or sharp metal scrapers to clean the oven door glass since they can scratch the surface, which may result in shattering of the glass.
- Do not use steam cleaners to clean the appliance as this may cause an electric shock.
- (Varies depending on the product model.)
Placing the wire shelf and tray onto the wire racks properly
It is important to place the wire shelf and/or tray onto the rack properly. Slide the wire shelf or tray between 2 rails and make sure that it is balanced before placing food on it (Please see the following figure).

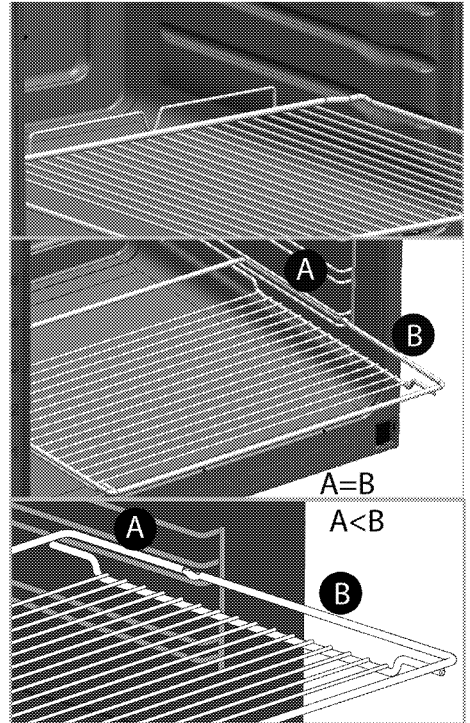

- Do not use the product if the front door glass is removed or cracked.
- Do not use the oven handle to hang towels for drying. Do not hang up towel, gloves, or similar textile products when the grill function is at open door.
- Always use heat resistant oven gloves when putting in or removing dishes into/from the hot oven.
- Place the baking paper into the cooking pot or on to the oven accessory (tray, wire grill etc) together with the

food and then insert all into the preheated oven. Remove the excess parts of the baking paper overflowing from the accessory or the pot in order to prevent the risk of touching the oven's heating elements. Never use the baking paper in an operating temperature higher than the indicated value for the baking paper. Do not place the baking paper directly on the base of the oven.

- **WARNING:** Ensure that power cord of the appliance is unplugged (**if the product is supplied with a plug**) or circuit breaker is switched off before replacing the lamp to avoid the possibility of electric shock.
- The appliance must not be installed behind a decorative door in order to avoid overheating.
- Product must be placed directly on the floor. It must not be placed onto a base or a pedestal.
- **WARNING:** Unattended cooking on a hob with fat or oil can be dangerous and

may result in fire. NEVER try to extinguish a fire with water, but switch off the appliance and then cover flame e.g. with a lid or a fire blanket.

- **CAUTION:** The cooking process has to be supervised. A short term cooking process has to be supervised continuously.
- **WARNING:** Danger of fire: Do not store items on the cooking surfaces.
- **WARNING:** If the surface is cracked, switch off the appliance to avoid the possibility of electric shock.
- In case of hotplate glass breakage : Immediately shut off all burners and any electrical heating element and isolate the appliance from the power supply. Do not touch the appliance surface. Do not use the appliance.
- After use, switch off the hob element by its control and do not rely on the pan detector.
- Metallic objects such as knives, forks, spoons and lids should not be placed on

the hob surface since they can get hot.

- The appliance is not intended to be operated by means of an external timer or separate remote-control system.
- Vapour pressure that build up due to the moisture on the hob surface or at the bottom of the pot can cause the pot to move. Therefore, make sure that the oven surface and bottom of the pots are always dry.
- Hotplates are equipped with "Induction" technology. Your induction hob that provides both time and money savings must be used with pots suitable for induction cooking; otherwise hotplates will not operate.
- As induction hobs create a magnetic field, they may cause harmful impacts for people who use devices such as insulin pump or pacemaker.
- Do not put electronic products such as mobile phones, tablets, computers on the induction cooker.

Your product may be damaged.

- **WARNING:** Use only hob guards designed by the manufacturer of the cooking appliance or indicated by the manufacturer of the appliance in the instructions for use as suitable or hob guards incorporated in the appliance. The use of inappropriate guards can cause accidents.

Prevention against possible fire risk!

- Ensure all electrical connections are secure and tight to prevent risk of arcing.
- Do not use damaged cables or extension cables.
- Ensure liquid or moisture is not accessible to the electrical connection point.

Intended use

- This product is designed for domestic use. Commercial use will void the guarantee.
- **CAUTION:** This appliance is for cooking purposes only. It must not be used for other purposes, for example room heating.

- This product should not be used for warming the plates under the grill, drying towels, dish cloths etc. by hanging them on the oven door handles. This product should also not be used for room heating purposes.
- The manufacturer shall not be liable for any damage caused by improper use or handling errors.
- The oven can be used for defrosting, baking, roasting and grilling food.

Safety for children

- **WARNING:** Accessible parts may become hot during use. Young children should be kept away.
- The packaging materials will be dangerous for children. Keep the packaging materials away from children. Please dispose of all parts of the packaging according to environmental standards.
- Electrical products are dangerous to children. Keep children away from the product when it is operating and do not allow them to play with the product.

- Do not place any items above the appliance that children may reach for.
- When the door is open, do not load any heavy object on it and do not allow children to sit on it. It may overturn or door hinges may get damaged.

Disposing of the old product

Compliance with the WEEE Directive and Disposing of the Waste Product:



This product complies with EU WEEE Directive (2012/19/EU). This product bears a classification symbol for waste electrical and electronic equipment (WEEE).

This product has been manufactured with high quality parts and materials which can be reused and are suitable for recycling. Do not dispose of the waste product with normal domestic and other wastes at the end of its service life. Take it to the collection center for the recycling of electrical and electronic equipment. Please consult your local authorities to learn about these collection centers.

Compliance with RoHS Directive:

The product you have purchased complies with EU RoHS Directive (2011/65/EU). It does not contain harmful and prohibited materials specified in the Directive.

Package information

- Packaging materials of the product are manufactured from recyclable materials in accordance with our National Environment Regulations. Do not dispose of the packaging materials together with the domestic or other wastes. Take them to the packaging material collection points designated by the local authorities.

2 General information

Overview

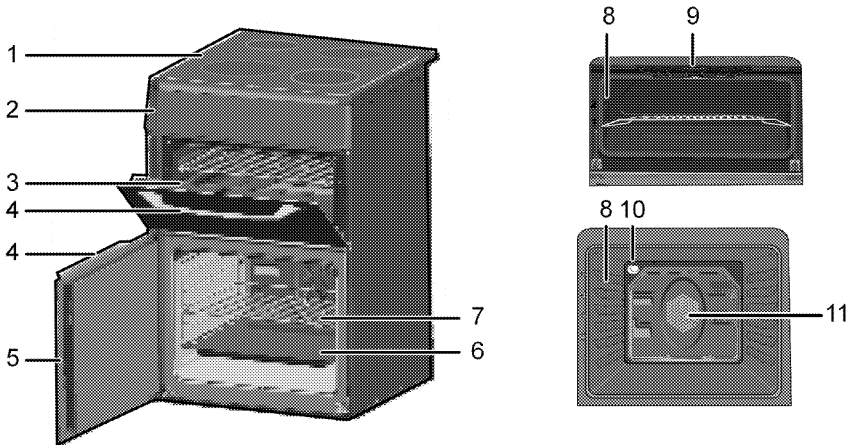

- 1 Burner plate
- 2 Control panel
- 3 Top oven door
- 4 Handle
- 5 Main oven door
- 6 Tray
- 7 Wire shelf
- 8 Shelf positions
- 9 Grill heating element
- 10 Lamp
- 11 Fan motor (behind steel plate)

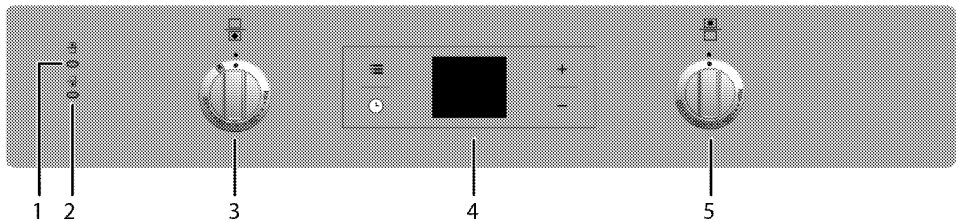

- 1 Thermostat lamp for top oven
- 2 Thermostat lamp for main oven
- 3 Main oven thermostat knob
- 4 Digital timer
- 5 Top oven thermostat knob

Package contents

i Accessories supplied can vary depending on the product model. Not every accessory described in the user manual may exist on your product.

1. User manual

2. Standard tray

Used for pastries, frozen foods and big roasts.

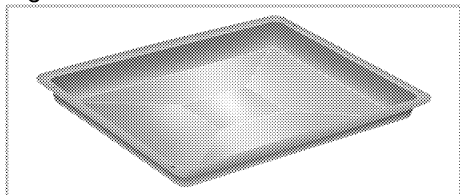

3. Wire grill

Used for roasting and for placing the food to be baked, roasted or cooked in casserole dishes to the desired rack.

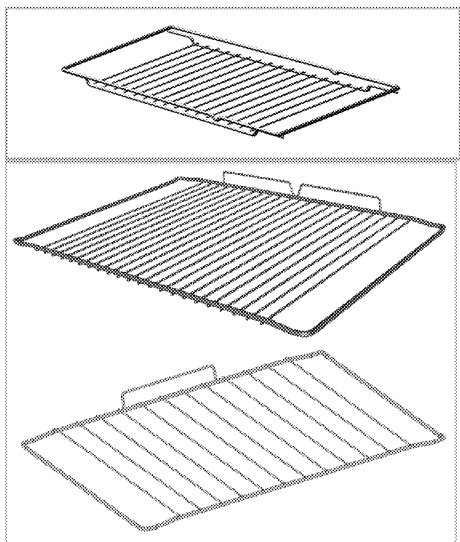

4. Small wire shelf

It is placed into the tray (if supplied) in order to collect the dripping fat while grilling so that the oven is kept clean.

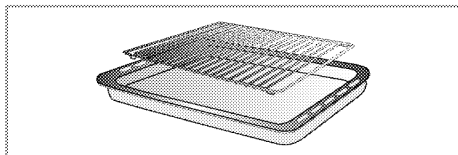

5. Placing the wire shelf and tray onto the telescopic racks properly (This feature is optional. It may not exist on your product.)

Telescopic racks allow you to install and remove the trays and wire shelf easily.

When using the tray and wire shelf with telescopic racks, make sure that the pins at the rear section of the telescopic rack stands against the edges of the wire shelf and tray.

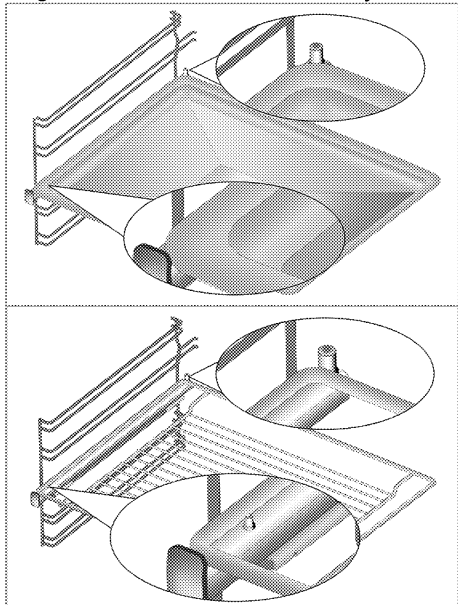

Technical specifications

GENERAL	
External dimensions (height / width / depth)	900 mm/600 mm/600 mm
Voltage / frequency	220-240 V 1N~/ 380-415 V 3N~ 50 Hz
Total power consumption	11,4 kW
Fuse	32 A (1N) / 3 x 16 A (3N)
Cable type / section	min.H05VV-FG 3 x 4 mm ² (1N) / 5 x 1,5 mm ² (3N) or equivalent
Burners	
Rear left	Induction cooking zone
Dimension	180 mm
Power	2000W / Booster: 2300 W
Front left	Induction cooking zone
Dimension	180 mm
Power	2000W / Booster: 2300 W
Front right	Induction cooking zone
Dimension	145 mm
Power	1600 W / Booster: 1800 W
Rear right	Induction cooking zone
Dimension	210 mm
Power	2000 W / Booster: 2300 W
OVEN/GRILL	
Top oven	Conventional oven / Grill oven
Grill power consumption	2,2 kW
Main oven	Fan oven
Inner lamp	15–25 W

Basics: Information on the energy label of electrical ovens is given in accordance with the EN 60350-1 / IEC 60350-1 standard. Those values are determined under standard load with bottom-top heater or fan assisted heating (if any) functions. Energy efficiency class is determined in accordance with the following prioritization depending on whether the relevant functions exist on the product or not. 1-Cooking with eco-fan, 2- Turbo slow cooking, 3- Turbo cooking, 4- Fan assisted bottom/top heating, 5-Top and bottom heating.



Technical specifications may be changed without prior notice to improve the quality of the product.



Figures in this manual are schematic and may not exactly match your product.



Values stated on the product labels or in the documentation accompanying it are obtained in laboratory conditions in accordance with relevant standards. Depending on operational and environmental conditions of the product, these values may vary.

3 Installation

Product must be installed by a qualified person in accordance with the regulations in force. The manufacturer shall not be held responsible for damages arising from procedures carried out by unauthorized persons which may also void the warranty.

i Preparation of location and electrical and gas installation for the product is under the installer's responsibility.

! The product must be installed in accordance with all local electrical regulations.

! Prior to installation, visually check if the product has any defects on it. If so, do not have it installed.
Damaged products cause risks for your safety.

Before installation

To ensure that critical air gaps are maintained under the appliance, we recommend that this appliance is mounted on a solid base and that the feet do not sink into any carpet or soft flooring.

The kitchen floor must be able to carry the weight of the appliance plus the additional weight of cookware and bakeware and food.

If the range is placed on a base, measures have to be taken to prevent the appliance slipping from the base. The appliances must not be installed behind a decorative door in order to avoid overheating.

- Movement of your appliance is most easily achieved by lifting the front as follows and pulling towards. Open the top oven door and the bottom

oven door sufficiently to allow a comfortable grip on the underside front edge of the oven roofs. While gripping, it should be avoided to damage any grill elements or oven interior furniture.

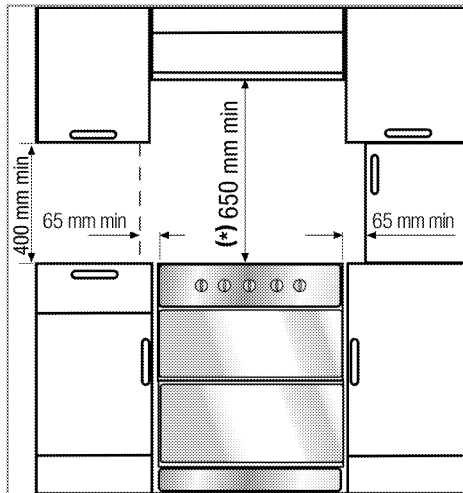

- The appliance corresponds to device class 1, i.e. it may be placed with the rear and **one** side to kitchen walls, kitchen furniture or equipment of any size. The kitchen furniture or equipment on the **other** side may only be of the same size or smaller.
- It can be used with cabinets on either side but in order to have a minimum distance of 400mm above hotplate level allow a side clearance of 65mm between the appliance and any wall, partition or tall cupboard.
- It can also be used in a free standing position. Allow a minimum distance of 650 mm above the hob surface.
- (*) If a cooker hood is to be installed above the cooker, refer to cooker hood manufacturer's instructions regarding installation height. If not defined any size in the hood manual,

this height should be at least 650 mm.

- Any kitchen furniture next to the appliance must be heat-resistant (100 °C min.).

Safety chain

If your product has 2 safety chains;

The appliance must be secured against overbalancing by using the supplied two safety chains on your oven.

Fasten hook (1) by using a proper peg to the kitchen wall (6) and connect safety chain (3) to the hook via the locking mechanism (2).

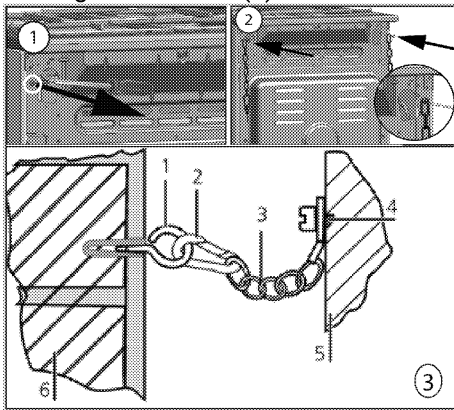

- 1 Stability hook
- 2 Locking mechanism
- 3 Safety chain (supplied and mounted to oven)
- 4 Firmly fix chain to cooker rear
- 5 Rear of cooker
- 6 Kitchen wall

If your product has 1 safety chain;

The appliance must be secured against overbalancing by using the supplied one safety chain on your oven.

Follow below steps in the picture to secure the safety chain to your product.

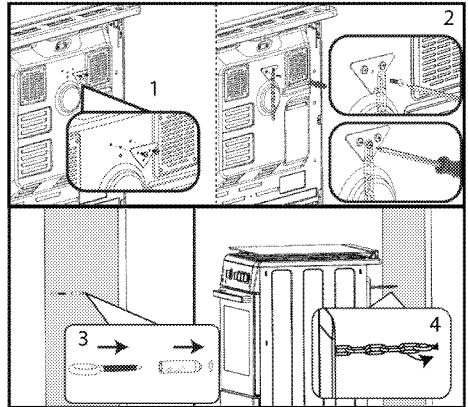

- **i** Stability chain to be as short as practicable to avoid oven tilting forward and diagonal to avoid oven side tilting.

Cooker stability chain for cookers is not designed with bracket engagement slot.

Installation and connection

Product can only be installed and connected in accordance with the statutory installation rules.

- **i** Do not install the product next to refrigerators or freezers. The heat emitted by the product will increase the energy consumption of cooling appliances.

- Carry the product with at least two persons.
- Product must be placed directly on the floor. It must not be placed onto a base or a pedestal.

- **i** Do not use the door and/or handle to carry or move the product. The door, handle or hinges get damaged.

Electrical connection

Connect the product to a grounded outlet/line protected by a miniature circuit breaker of suitable capacity as stated in the "Technical specifications"

table. Have the grounding installation made by a qualified electrician while using the product with or without a transformer. Our company shall not be liable for any damages that will arise due to using the product without a grounding installation in accordance with the local regulations.

! The product must be connected to the mains supply only by an authorised and qualified person. Manufacturer shall not be held responsible for damages arising from procedures carried out by unauthorised persons.

! The power cable must not be clamped, bent or trapped or come into contact with hot parts of the product. A damaged power cable must be replaced by a qualified electrician. Otherwise, there is risk of electric shock, short circuit or fire!

The mains supply data must correspond to the data specified on the type label of the product. The rating plate is either seen when the door or the lower cover is opened or it is located at the rear wall of the unit depending on the unit type. Power cable of your product must comply with the values in "Technical specifications" table.

! Before starting any work on the electrical installation, disconnect the product from the mains supply. There is the risk of electric shock!

Connecting the power cable

1. This product must only be connected by a qualified electrician such as a

technician from the local electricity company or NICEIC registered contractor to a suitable double-pole control unit with a minimum contact clearance of 3 mm in all poles. This control unit must be installed in accordance with the IEE directives. Failure to obey this instruction may cause operational problems and invalidate the product warranty.

Additional protection by a residual current circuit breaker is recommended.

If a cable is supplied with the product:

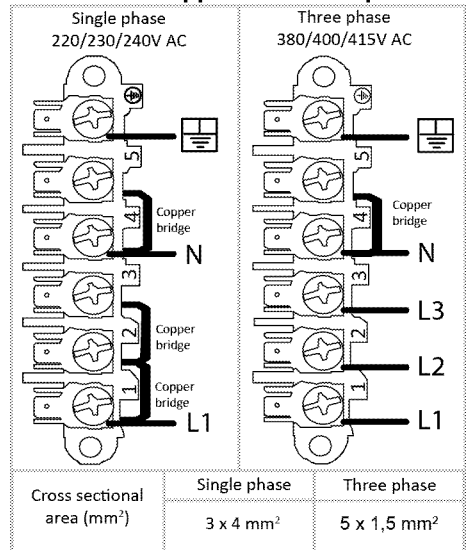

2. **For single-phase connection**, connect as identified below:

- Brown cable = L (Phase)
- Blue cable = N (Neutral)
- Green/yellow cable = (E) (Ground)

3. **For three-phase connection**, connect the wires as identified below:

- Brown cable = L1 (Phase 1)
- Grey/Black cable = L2 (Phase 2)
- Grey/Black cable = L3 (Phase 3)
- Blue cable = N (Neutral)
- Green/yellow cable = (E) (Ground)

Adjusting the feet of oven

Vibrations during use may cause cooking vessels to move. This dangerous situation can be avoided if the product is level and balanced.

For your own safety please ensure the product is level by adjusting the four feet at the bottom by turning left or right and align level with the work top.

Final check

- 1.Reconnect the product to the mains.
- 2.Check electrical functions.

For equipment with a cooling fan

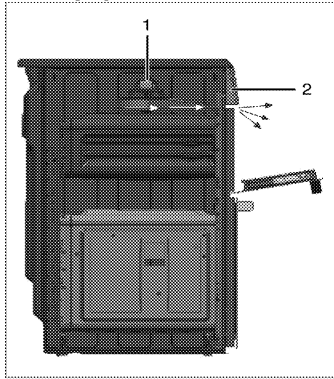

- 1 Fan
- 2 Control panel

While open door grilling, in order to protect control panel, knobs and

related oven parts; a fan automatically starts working.



Fan continues working until the product cools down.

Future Transportation

- Keep the product's original carton and transport the product in it. Follow the instructions on the carton. If you do not have the original carton, pack the product in bubble wrap or thick cardboard and tape it securely.
- To prevent the wire grill and tray inside the oven from damaging the oven door, place a strip of cardboard onto the inside of the oven door that lines up with the position of the trays. Tape the oven door to the side walls.
- Do not use the door or handle to lift or move the product.



Do not place any objects onto the product and move it in upright position.



Check the general appearance of your product for any damages that might have occurred during transportation.

4 Preparation

Tips for saving energy

The following information will help you to use your appliance in an ecological way, and to save energy:

- Use dark coloured or enamel coated cookware in the oven since the heat transmission will be better.
- While cooking your dishes, perform a preheating operation if it is advised in the user manual or cooking instructions.
- Do not open the door of the oven frequently during cooking.
- Try to cook more than one dish in the oven at the same time whenever possible. You can cook by placing two cooking vessels onto the wire shelf.
- Cook more than one dish one after another. The oven will already be hot.
- You can save energy by switching off your oven a few minutes before the end of the cooking time. Do not open the oven door.
- Defrost frozen dishes before cooking them.
- Use pots/pans with cover for cooking. If there is no cover, energy consumption may increase 4 times.
- Select the burner which is suitable for the bottom size of the pot to be used. Always select the correct pot size for your dishes. Larger pots require more energy.
- Pay attention to use flat bottom pots when cooking with electric hobs. Pots with thick bottom will provide a better heat conduction. You can obtain energy savings up to 1/3.
- Vessels and pots must be compatible with the cooking zones. Bottom of the vessels or pots must not be smaller than the hotplate.

- Keep the cooking zones and bottom of the pots clean. Dirt will decrease the heat conduction between the cooking zone and bottom of the pot.
- Information on energy efficiency according to EU 66/2014 can be found on the product fiche given with the product.

Initial use

Time setting

- **i** While making any adjustment, related symbols will flash on the display.

Press **+**/**-** keys to set the time of the day after the oven is energized for the first time.

- **i** For touch control models, touch  first and then use **+** / **-** to set the time of the day.

Confirm the setting by touching  symbol and wait for 4 seconds without touching any keys to confirm.

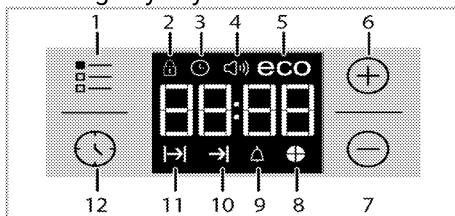

- 1 Adjustment key
 - 2 Key lock symbol
 - 3 Clock symbol
 - 4 Alarm volume symbol *
 - 5 Eco mode symbol
 - 6 Plus key
 - 7 Minus key
 - 8 Time slice symbol
 - 9 Alarm symbol
 - 10 End of Cooking Time symbol*
 - 11 Cooking Time symbol
 - 12 Program key
- * (Varies depending on the product model.)

i If the initial time is not set, clock will run starting from **12:00** and  symbol will be displayed. The symbol will disappear once the time is set.

i Current time settings are canceled in case of power failure. It needs to be readjusted.

First cleaning of the appliance

i The surface might get damaged by some detergents or cleaning materials.
Do not use aggressive detergents, cleaning powders/creams or any sharp objects during cleaning.
Do not use harsh abrasive cleaners or sharp metal scrapers to clean the oven door glass since they can scratch the surface, which may result in shattering of the glass.

1. Remove all packaging materials.
2. Wipe the surfaces of the appliance with a damp cloth or sponge and dry with a cloth.

Initial heating

Heat up the product for about 30 minutes and then switch it off. Thus, any production residues or layers will be burnt off and removed.

 Hot surfaces cause burns!
Product may be hot when it is in use. Never touch the hot burners, inner sections of the oven, heaters and etc. Keep children away.
Always use heat resistant oven gloves when putting in or removing dishes into/from the hot oven.

Electric oven

1. Take all baking trays and the wire grill out of the oven.
2. Close the oven door.
3. Select the highest grill power; See *How to operate the electric oven, page 30*.
4. Operate the oven for about 30 minutes.
5. Turn off your oven; See *How to operate the electric oven, page 30*

Grill oven

1. Take all baking trays and the wire grill out of the oven.
2. Close the oven door.
3. Select the highest oven power for grill oven; see *How to operate the top oven, page 35*.
4. Operate the grill about 15 minutes.
5. Turn off your grill; see *How to operate the top oven, page 35*

i Smoke and smell may emit for a couple of hours during the initial operation. This is quite normal. Ensure that the room is well ventilated to remove the smoke and smell. Avoid directly inhaling the smoke and the smell that emits.

5 How to use the hob

General information on hob usage

General warnings

- Do not let any objects to fall on the hob. Even small objects such as saltshakers may damage the hob. Do not use cracked hobs. Water may seep through these cracks and cause a short circuit. If the surface is damaged in any way (e.g. visible cracks), turn off the fuse first, then call the authorized service to unplug the product to reduce the risk of electric shock.
- Do not use unbalanced and easily tilting pots/pans on the hob.
- Do not heat the pots/pans and pots empty. The pots and the appliance may be damaged.
- Always turn off the hob's burners after each use.
- You shall damage the appliance if you operate the hobs without any pot or pots/pans. Always turn off the hobs after each operation.
- After each use the cooking surface will be hot, so do not put the plastic pots/pans on the cooking surface. Clean such material on the surface immediately.
- Sudden temperature changes on the glass cooking surface may cause damage, be careful not to spill cold liquids during cooking.
- Put a sufficient amount of food in pots and pans. Thus, you can prevent food from pouring forth out of the pots/pans and will not need to clean unnecessarily.
- Do not place the covers of pots and pans on burners/zones.
- Place the pots by centering them on the burners/zones. If you wish to place a pot on a different burner/zone, do not slide it towards the desired burner;

rather, lift it first and then put it on the other burner.

Operating principle of the induction hob

Induction hob is like an open circuit. The circuit completes when a cooking pots/pans suitable for induction cooking is placed on it and an electronic system below the glass surface generates a magnetic field. The metal base of the pots/pans is heated by taking energy from this magnetic field. Thus, the heat is not generated on the surface of the hob, but directly on the pots/pans above it. Glass surface is heated with the heat of the cooking pots/pans.

Advantages of cooking with induction

Induction hobs offer some advantages as the heat is transferred directly to the cooking pots/pans.

- Foods that overflow during cooking do not burn rapidly as the glass cooking surface is not heated directly. It is cleaned more easily.
- Cooking shall be faster as the heat is generated directly on the cooking pots/pans. Thus, it saves time and energy with respect to other hob types.
- As the heat is given directly to the cooking pots/pans, there is no heat loss, and it provides a more efficient cooking.
- The fact that the heat transfer stops and the cooking surface is not heated directly when the cooking pots/pans is removed from the cooking surface provides a safer use against possible accidents while cooking.

For a safe operation:

- Do not select high heating levels when using non-sticking cooking pots/pans coated with little amount of oil or used without oil (teflon type).

- Do not use glass cooking surface as a surface where you can place something on it or as a cutting surface.
- Do not place metal objects such as cutlery or pot lids on your hob as they may get hot.
- Never use aluminium foil for cooking. Never place food wrapped in aluminium foil on the induction zone.
- Keep magnetic objects such as credit cards or tapes away from the hob while it is operating.
- If there is an oven under your hob and it is being operated, the sensors on the hob may reduce the cooking level or turn off the hob.
- Your hob has an automatic shut-off system. Detailed information about this system is provided in the following sections. However, if you use thin based pots for your cooking, these pots shall heat up very quickly and the bottom of the pan may melt and damage the cooking surface and the appliance before the automatic shut-off system is activated.

Cooking pots/pans

You shall use ferromagnetic, quality cooking pots/pans which bear a label or warning that it is compatible for induction cooking only with your induction hob. Generally, the higher the iron content, the better the cooking pots/pans shall perform. The base diameter of the cooking pots/pans shall match the induction zone. Suggested dimensions are listed below.

Suitable pots/pans:

- Cast iron pots/pans
- Enamelled steel pots/pans
- Steel and stainless steel pots/pans (with label or warning indicating that it is induction compatible)

Unsuitable pots/pans:

- Aluminium pots/pans
- Copper pots/pans
- Brass pots/pans

- Glass pots/pans
- Pottery
- Ceramic and porcelain

Recommendations:

- Use flat bottomed cooking pots/pans only. Do not use pots/pans with convex or concave bases.

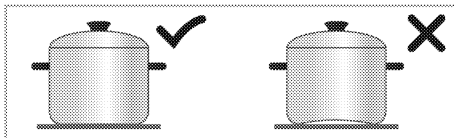

- Use cooking pots/pans with thick, processed bases only. If you use thin based pots, these pots shall heat up very quickly and the bottom of the pan may melt and damage the cooking surface and the appliance before the automatic shut-off system is activated. Sharp edges may cause scratches on the surface.

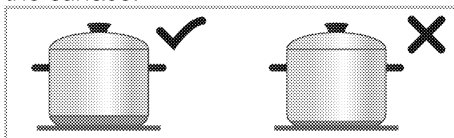

- The bases of some cooking pots/pans have a smaller ferromagnetic field than its true diameter. Only this area is heated by the hob. Therefore, the heat is not evenly distributed and the cooking performance is decreased. Moreover, such cooking pots/pans may not be detected by large induction hobs. Thus, the cooking hob shall be selected according to the size of the ferromagnetic field.

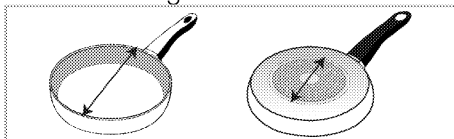

- Some cooking pots/pans have a base that contains non-ferromagnetic materials such as aluminium. These types of cooking pots/pans may not heat adequately or may not be detected by the induction hob at all. In

some cases, a bad pots/pans warning may appear.

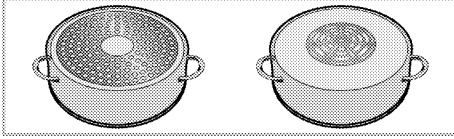

i Equal distribution of the cookware on the right and left and center hobs for the selection of hobs affects the cooking performance positively while cooking multiple meals on the induction hobs.

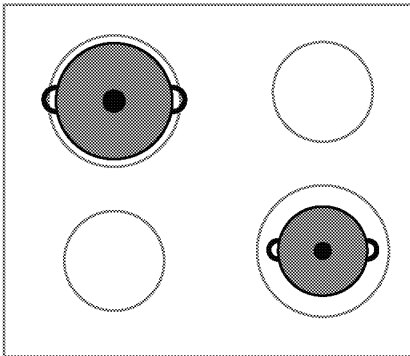
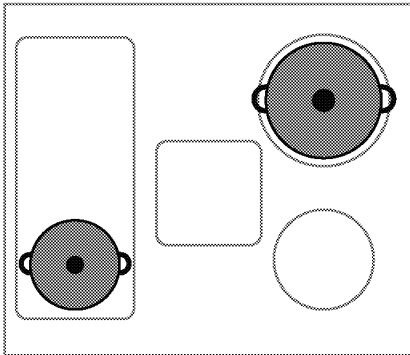

Cooking pots/pans test

Test whether your pot is compatible with cooking with an induction hob using the methods below.

1. It is compatible if the base of your pot holds a magnet.
2. It is compatible if "L" does not flash when you place your pot on the induction hob and turn on the hob.

Recommended cooking pots/pans sizes

Diameter of cooking zone - mm	Pot diameter - mm
145	min. 100 - max 145
180	min. 100 - max 180
210	min. 140 - max 210
240	min. 140 - max 240
280	min. 125 - max 280
320	min. 125 - max 320

The detection of cooking pots/pans by the induction hobs depend on the diameter and material of the ferromagnetic in the base of the pots/pans. To ensure detection of the cooking pots/pans and achieve an efficient cooking, the cooking pots/pans shall be selected as per the size of your hob. The cooking pots/pans sizes recommended for hob sizes are given above.

Boiling behavior may vary depending on the pot types, size of the pot and size of the cooking zone. For a more homogenous boiling behavior, a one step larger cooking zone might be used. To use a larger cooking zone does not cause wasting of energy at induction hobs, because the heat is only created in the relevant pot area.

Control panel

i Key lock will be cancelled in case of power failure.

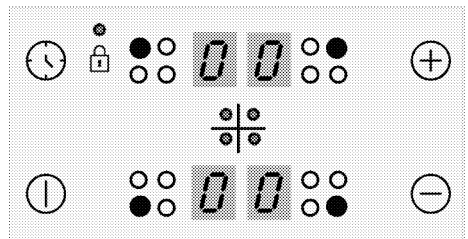

Keys

- ⏻ : On/Off key
- 🕒 : Timer key
- ⊕ : Increase key
- ⊖ : Decrease key

Symbols

 : Key lock symbol

Cooking zone selection keys

 : Rear left cooking zone selection key

 : Front left cooking zone selection key

 : Front right cooking zone selection key

 : Rear right cooking zone selection key

 Graphics and figures are for informational purposes only. Actual displays and functions may vary according to the model of your hob.

 This product is controlled with a touch control panel. Each operation you make on your touch control panel will be confirmed by an audible signal.

 Always keep the control panel clean and dry. Having damp and soiled surface may cause problems in the functions.

Turning on the hob

1. Touch the  key on the control panel. "0" icon appears on all cooking zone displays.

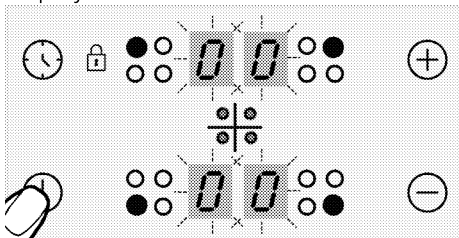

 If no operation is performed within 20 seconds, the hob will automatically return to Standby mode.

Turning off the hob

1. Touch the  key on the control panel. The hob will turn off and return to Standby mode.

 "H" or "h" symbol that appears on the cooking zone display indicates that the cooking zone is still hot. Do not touch cooking zones.

Residual heat indicator

"H" symbol that appears on the cooking zone display indicates that the hob is still hot and may be used to keep a small amount of food warm. This symbol will soon turn to "h" symbol meaning less hot.

 When power is cut off, residual heat indicator will not light up and does not warn the user against hot cooking zones.

Turning on the cooking zones

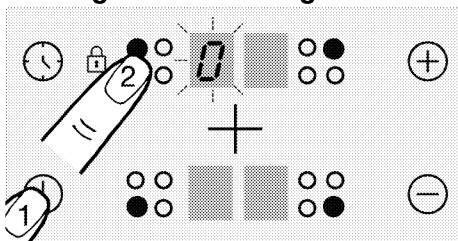

1. Touch  key to turn on the hob.
2. Touch the selection key of the cooking zone you want to turn on.

"0" symbol appears on the cooking zone display and the related display illuminates more brightly.

 If no operation is performed within 20 seconds, the hob will automatically return to Standby mode.

Setting the temperature level

i The product might start-stop when it is operating on levels from 1 to 7, especially with cookware with a small diameter and when water-oil is little. This is not a fault.

Touch ⊕ or ⊖ keys to set the temperature level between "1" and "9" or "9" and "1".

i The outer section of the 280 mm induction hob cooking zone (if your product is equipped with a 280 mm induction hob cooking zone) is activated only when a saucepan large enough to cover the cooking zone is placed on the cooking zone and the temperature is set to a level higher than 8.

Turning off the cooking zones:

A cooking zone can be turned off in 3 different ways:

1. By dropping the temperature level to "0"

You can turn the cooking zone off by dropping the temperature adjustment to "0" level.

2. By touching the relevant cooking zone symbol for a certain time

Turn on the cooking zone by pressing relevant symbol for a certain time to drop temperature value to "0".

3. By using the turn-off on the timer option for the desired cooking zone

When the time is over, the timer will turn off the cooking zone assigned to it. "0" or "00" will appear on related display.

When the time is over, an audible alarm will sound. Touch any key on the control panel to silence the audible alarm.

High Power (Booster)

(This feature is optional. It may not exist on your product.)

For rapid heating, you can use booster function "P". However, this function is not recommended for cooking a long time. Booster function may not be available in all cooking zones.

Turning on High Power (Booster) :

1. Touch ⊕ key to turn on the hob.
2. Select the desired cooking zone by touching the cooking zone selection keys.
3. Touch ⊕ or ⊖ key firstly to reach the level "9".

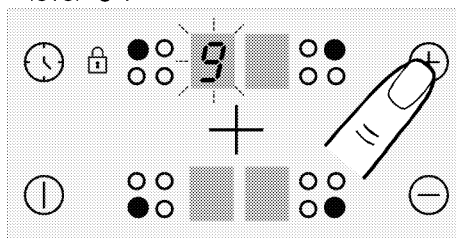

4. When the cooking zone is at level "9", touch ⊕ key once to set cooking zone temperature to "P".

Turning off High Power (Booster) :

- To disable the Booster function, touch ⊖ and set the temperature to level "9". Cooking zone goes out of booster and continues to operate at level "9".
- You can decrease the temperature level by touching ⊖ or you can switch off the cooking zone completely by decreasing the temperature level to "0".

Keylock

You can activate the keylock to avoid changing the functions by mistake when the hob is operating.

Activating the keylock

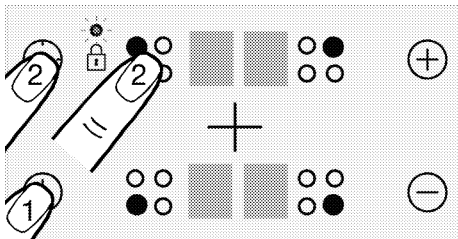

1. Touch ⊕ key to turn on the hob.
2. Touch ⊕ and ⊗ keys simultaneously to activate the keylock.



» Keylock will be activated and the dot on the symbol  will light up.

- i** If you turn the hob off when the keys are locked, the keylock will be activated next time you turn the hob on again. Key lock must be deactivated in order to be able to operate the hob.

Deactivating the keylock





1. When the keylock is active, touch  and  keys simultaneously.
- » Keylock will be deactivated and the dot on the symbol  will disappear.

Childlock (This feature is optional. It may not exist on your product.)

You can protect the hob against being operated unintentionally in order to prevent children from turning on the cooking zone. Child Lock can only be activated and deactivated in Standby mode.



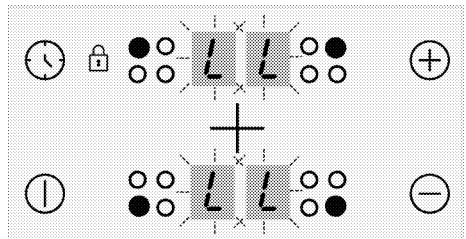

- i** Child lock will be cancelled in case of power failure.

Activating the childlock (This feature is optional. It may not exist on your product.)

1. Touch  key to turn on the hob.
 2. Touch  and  keys simultaneously. After "beep" signal touch  to activate the childlock.
- » Childlock will be activated and "L" symbol appears on all cooking zone display.



Deactivating the childlock (This feature is optional. It may not exist on your product.)

1. When the keylock is active, touch  key to turn on the hob.
 2. Touch  and  keys simultaneously. After "beep" signal touch  to deactivate the childlock.
- » Childlock will be deactivated and "L" symbol disappears on all cooking zone display.



Timer function

This function facilitates cooking for you. It will not be necessary to attend the oven for the whole cooking period. Cooking zone will be turned off automatically at the end of the time you have selected.

Activating the timer

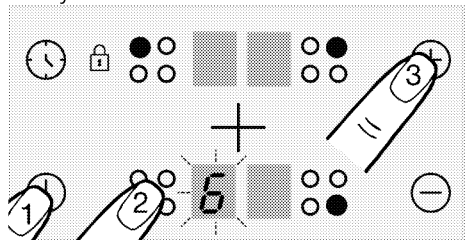
1. Touch  key to turn on the hob.
2. Select the desired cooking zone by touching the cooking zone selection keys.



3. Touch  or  keys to set the desired temperature level.
4. Touch  key to turn the timer on. "00" symbol will illuminate on timer display and decimal point will appear on the selected cooking zone display.

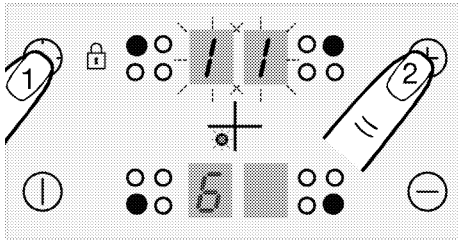

- i** Right rear and left rear cooking zone displays serve as timer display when the timer is active.

5. Touch \oplus or \ominus keys to set the desired time.

- i** The timer can only be set for the cooking zones already in use.
- i** Repeat the above procedures for the other cooking zones for which you wish to set the timer.
- i** Timer cannot be adjusted unless the cooking zone and the temperature value for the cooking zone are selected.
- i** When the cooking zone for which a timer was set is selected, you can see the remaining time by touching the ⌚ key again.

Deactivating the timer

Once the set time is over, the hob will automatically turn off and give an audible warning.

Press any key to silence the audio warning.

Turning off the timers earlier

If you turn off the timer earlier, the hob will carry on operating at the set temperature until it is turned off.

1. Select the cooking zone you want to turn off.

2. Touch ⌚ key to turn the timer on.
3. Until "00" appears on the timer screen, touch \ominus to set the value to "00".

Dot shaped light on the relevant cooking zone display itself turns off **completely** after having flashed for a certain period of time and the timer is cancelled.

Using induction cooking zones safely and efficiently

Operating principles: Induction hob heats directly the cooking vessel as a feature of its operating principles.

Therefore, it has various advantages when compared to other hob types. It operates more efficiently and the hob surface does not heat up.

Induction hob is equipped with superior safety systems that will provide you maximum usage safety.

- i** Your hob can be equipped with induction cooking zones with a diameter of 145, 180, 210-280 mm depending on the model. With induction feature, each cooking zone detects each vessel placed on them. Energy builds up only where the vessel contacts with the cooking zone and thus, minimum energy consumption is achieved.

Automatic turning off system

The hob control has an automatic turn off system. If one or more hob zone(s) are left on, the hob zone turns off automatically after a while (See Table-1).

In case of a timer assigned to the hob, the timer screen is turned off then, too.

The time limit for automatic turn off depends on the selected temperature level. Maximum operating period is applied for this temperature level.

The hob zone may be operated by the user again after it is turned off automatically as described above.

Table-1: Automatic turning off periods

Temperature level	Automatic turning off periods - hours
0	0
1	6
2	6
3	5
4	5
5	4
6	1,5
7	1,5
8	1,5
9	20-30 mins.
P (Booster)	5-10 mins. (*)
(*) The hob will drop to level 9 after 5 minutes	

Overheating protection

Your hob is equipped with some sensors ensuring protection against overheating. Following may be observed in case of overheating:

- Active cooking zone may be turned off.
- Selected level may drop. However, this condition cannot be seen on the indicator.

Overflow safety system

Your hob is equipped with overflow safety system. If there is any overflow that spills onto the control panel, system will cut the power connection immediately and turn off your hob. "F" warning appears on display during this period.

Precise power setting

Induction hob reacts the commands immediately as a feature of its operating principles. It changes the power settings very fast. Thus, you can prevent a cooking pot (containing water, milk and etc.) from overflowing even if it was just about to overflow.

 If the surface of the touch control panel is exposed to intense vapor, entire control system may become deactivated and give error signal.

 Keep the surface of the touch control panel clean. Erroneous operation may be observed.

6 How to operate the oven

General information on baking, roasting and grilling



Hot surfaces cause burns! Product may be hot when it is in use. Never touch the hot burners, inner sections of the oven, heaters and etc. Keep children away. Always use heat resistant oven gloves when putting in or removing dishes into/from the hot oven.



Be careful when opening the oven door as steam may escape. Exiting steam can scald your hands, face and/or eyes.

Tips for baking

- Use non-sticky coated appropriate metal plates or aluminum vessels or heat-resistant silicone moulds.
- Make best use of the space on the rack.
- Place the baking mould in the middle of the shelf.
- Select the correct rack position before turning the oven or grill on. Do not change the rack position when the oven is hot.
- Keep the oven door closed.

Tips for roasting

- Treating whole chicken, turkey and large piece of meat with dressings such as lemon juice and black pepper before cooking will increase the cooking performance.
- It takes about 15 to 30 minutes longer to roast meat with bones when compared to roasting the same size of meat without bones.

- Each centimeter of meat thickness requires approximately 4 to 5 minutes of cooking time.
- Let meat rest in the oven for about 10 minutes after the cooking time is over. The juice is better distributed all over the roast and does not run out when the meat is cut.
- Fish should be placed on the middle or lower rack in a heat-resistant plate.

Tips for baking

- Select the correct shelf position before turning the oven on – shelf positions are counted from the bottom upwards.
- Always preheat the oven first to ensure the food is at the correct temperature as soon as it goes into the oven.
- Use good quality baking tins such as non stick or aluminium. Line tins with greaseproof or baking paper to prevent sticking, if necessary.
- Do not fill cake tin more than half full.
- If baking one tray of food or cake, place centrally on the shelf level and centrally in the oven.
- Do not to open the oven door too much during cooking.
- To check if a cake is cooked, insert a skewer or cocktail stick into the centre. If it comes out clean, the cake is done, if it has food stuck to it, continue to cook the cake for a few minutes more and repeat the process.

Tips for roasting

Preheat oven first.

- If possible take meat or poultry out of refrigerator 30 minutes before cooking.
- Weigh meat first and calculate how long it will take to cook.

- Before cooking meat or poultry, lightly coat with butter or oil and season with salt, pepper, herbs, or other seasoning. Place in a roasting dish and use a rack to lift the meat out of its juices. Place dish in centre of oven.
- Turn meat over halfway through cooking.
- If the roasted meat is covered with foil, (it helps to keep the oven clean), always uncover for the last half an hour of cooking to allow browning.
- Remove meat from oven once cooked and stand covered in foil for 10-15 minutes to allow the meat to relax and juices to be reabsorbed which ensures the roast is tender and moist..

How to operate the electric oven

Product is equipped with two ovens. Overview section indicates the relevant knobs for each oven.

How to operate the main oven / Easy Steam Cleaning

Select temperature and operating mode

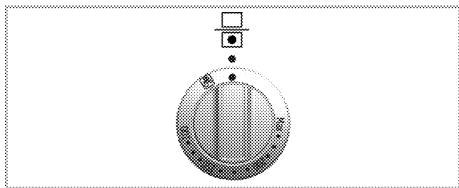

or

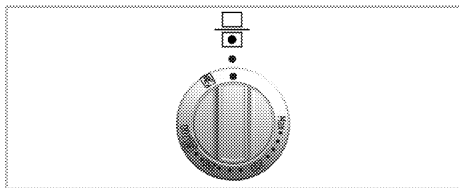

1. Set the Function knob to the desired temperature.

» Oven heats up to the adjusted temperature and maintains it. During heating, temperature lamp stays on. This function must be used for easy steam cleaning as well.

Switching off the electric oven

Turn the Function knob to Off (top) position.

Rack positions (For models with wire shelf)

It is important to place the wire shelf onto the side rack correctly. Wire shelf must be inserted between the side racks as illustrated in the figure. Do not let the wire shelf stand against the rear wall of the oven. Slide your wire shelf to the front section of the rack and settle it with the help of the door in order to obtain a good grill performance.

(Varies depending on the product model.)

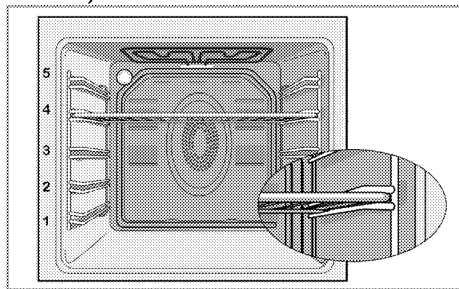

Using the oven clock

- i** The oven clock only controls the bottom oven. It has no effect for the top oven.

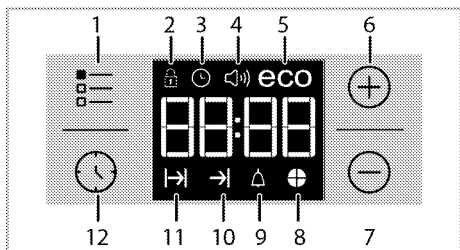

- 1 Adjustment key
 - 2 Key lock symbol
 - 3 Clock symbol
 - 4 Alarm volume symbol *
 - 5 Eco mode symbol
 - 6 Plus key
 - 7 Minus key
 - 8 Time slice symbol
 - 9 Alarm symbol
 - 10 End of Cooking Time symbol*
 - 11 Cooking Time symbol
 - 12 Program key
- * (Varies depending on the product model.)

- i** Maximum time that can be set for end of cooking is 5 hours 59 minutes.
Program will be cancelled in case of power failure. You must reprogram the oven.
- i** While making any setting, related symbols will flash on the display. You must wait for a short time for the settings to take effect.
- i** If no cooking setting is made, time of the day cannot be set.
- i** Remaining time will be displayed if cooking time is set when the cooking starts.

Cooking by setting the cooking time;
You can set the oven so that it will stop at the end of the specified time by setting the cooking time on the timer.

1. Select the function for cooking.

2. Touch until symbol appears on display for cooking time.
3. Set the cooking time with **+** / **-** keys.
» » After the cooking time is set, symbol and the time slice will appear on display continuously.
4. Place the dish into the oven and set the temperature with temperature knob. Cooking will start.
» Cooking time starts to count down on display when cooking starts and all parts of time slice symbol is lit. The set cooking time is divided into 4 equal parts and when the time of each parts ends, the symbol of that parts turns off. So you can understand the ratio of remaining cooking time to total cooking time easily.
5. After the cooking process is completed, "End" appears on the displayed and the timer gives an audio warning.

- i** If you press any key at the end of the audio warning, the oven will restart operating. Turn the temperature knob and function knob to "0" (off) position to switch off the oven in order to prevent re-operation of the oven at the end of warning.



Activating the keylock

You can prevent digital timer from being intervened with by activating the key lock function.

1. Touch until symbol appears on display.
» "OFF" will appear on the display.
2. Press **+** to activate the key lock.
» Once the key lock is activated, "On" appears on the display and the symbol remains lit.

- i** Digital timer keys are not functional when the key lock is activated. Key lock will not be cancelled in case of power failure.

To deactivate the keylock





1. Touch  until  symbol appears on display.
» "On" will appear on the display.
2. Disable the key lock by pressing the  key.
» "OFF" will be displayed once the keylock is deactivated.

Setting the alarm clock



You can use the timer of the product for any warning or reminder apart from the cooking program.

The alarm clock has no influence on the functions of the oven. It is only used as a warning. For example, this is useful when you want to turn food in the oven at a certain point of time.

Timer will give an audio warning at the end of the set time.

1. Touch  until  symbol appears on display.
i Maximum alarm time can be 23 hours and 59 minutes.
2. Set the alarm duration by using  /  keys.



- i** Function keys for alarm tone, time of day, display brightness and temperature keys should be at 0 (OFF) position.

- »  symbol will remain lit and the alarm time will appear on the display once the alarm time is set.
3. At the end of the alarm time,  symbol starts flashing and the audio warning is heard.

Turning off the alarm





1. Audio warning sounds for 2 minutes.
To stop the audio warning, just press any key.
» Audio warning will be silenced and current time will be displayed.

Cancelling the alarm;

1. Touch  until  symbol appears on display in order to cancel the alarm.
2. Press and hold  key until "00:00" is displayed.





- i** Alarm time will be displayed. If the alarm time and cooking time are set concurrently, shortest time will be displayed.

Changing alarm tone

1. Touch  until  symbol appears on display.
2. Adjust the desired alarm tone with  /  keys.
3. The tone you have set will be activated in a short time.
» Selected alarm tone will appear as "b-01", "b-02" or "b-03" on the display.

Changing the time of the day

To change the time of the day you have previously set:

1. Touch  until  symbol appears on display.
2. Set the time of the day with  /  keys.
3. The time you have set will be activated in a short time.

Economy mode

You can save energy with economy mode while cooking by setting cooking time in the oven.

This mode completes the cooking with the inner temperature of the oven by switching off the heaters before the end of cooking time.

Setting the economy mode

1. Touch  symbol until **eco** symbol appears on display.
 - » "OFF" will appear on the display.
2. Enable economy mode by touching **+** key.
 - » Once the economy mode is activated, "On" appears on the display and the eco symbol remains lit.

Disabling economy mode

1. Touch  symbol until **eco** symbol appears on display.
 - » "On" will appear on the display.

Cooking times table

 The timings in this chart are meant as a guide. Timings may vary due to temperature of food, thickness, type and your own preference of cooking.

2. Disable economy mode by touching **-** key.
 - » "Off" will be displayed once the eco mode is deactivated.

Setting the screen brightness (This feature is optional. It may not exist on your product.)

1. Touch  until **d-01** or **d-02** or **d-03** appears on display for display brightness.
2. Set the desired brightness with **+** / **-** keys.
 - » The time you have set will be activated in a short time.

Baking and roasting

 1st rack of the oven is the **bottom** rack.

Dish	Cooking level number	Rack position	Temperature (°C)	Cooking time (approx. in min.)
Cakes in tray*	One level	3	175	30 ... 45
Cakes in mould*	One level	2	175	30 ... 50
Cakes in cooking paper*	One level	3	160 ... 170	20 ... 30
Sponge cake*	One level	3	180 ... 200	10 ... 20
Cookies*	One level	3	160 ... 170	20 ... 30
Dough pastry*	One level	3	200	20 ... 30
Rich pastry*	One level	3	190	20 ... 35
Leaven*	One level	3	190	20 ... 40
Lasagna*	One level	3	180	25 ... 45
Beef steak (whole) / Roast	One level	2	25 min. 220, then 180 ... 190	80 ... 120
Leg of Lamb (casserole)	One level	2	25 min. 220 then 180 ... 190	70 ... 100
Roasted chicken	One level	2	15 min. 220, then 190	55 ... 75
Turkey (Sliced)	One level	3	25 min. 220, then 190	70 ... 120
Fish	One level	3	200	20 ... 30

When cooking with 2 trays at the same time, place the deeper tray on the upper rack and the other one on the lower rack.

* It is suggested to perform preheating for all foods.

Tips for baking cake

- If the cake is too dry, increase the temperature by 10°C and decrease the cooking time.
- If the cake is wet, use less liquid or lower the temperature by 10°C.
- If the cake is too dark on top, place it on a lower rack, lower the temperature and increase the cooking time.
- If cooked well on the inside but sticky on the outside use less liquid, lower the temperature and increase the cooking time.

Tips for baking pastry

- If the pastry is too dry, increase the temperature by 10°C and decrease the cooking time. Dampen the layers of dough with a sauce composed of milk, oil, egg and yoghurt.
- If the pastry takes too long to bake, pay care that the thickness of the pastry you have prepared does not exceed the depth of the tray.
- If the upper side of the pastry gets browned, but the lower part is not cooked, make sure that the amount of sauce you have used for the pastry is not too much at the bottom of the pastry. Try to scatter the sauce equally between the dough layers and on the top of pastry for an even browning.

 Cook the pastry in accordance with the mode and temperature given in the cooking table. If the bottom part is still not browned enough, place it on one lower rack next time.

Tips for cooking vegetables

- If the vegetable dish runs out of juice and gets too dry, cook it in a pan with

- a lid instead of a tray. Closed vessels will preserve the juice of the dish.
- If a vegetable dish does not get cooked, boil the vegetables beforehand or prepare them like canned food and put in the oven.

How to operate the top oven

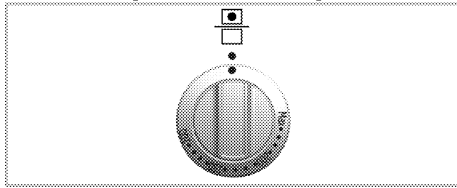

The grill oven can be used as grill or as baking oven. The oven door operates a door switch switching between grill and oven operation.

Select temperature and operating mode

1. Set the Function knob to the desired temperature.

» Oven heats up to the adjusted temperature and maintains it. During heating and cooling, thermostat light turns on.

Switching off the electric oven

Turn the Function knob to Off (top) position.

Cooking times table

- i** The timings in this chart are meant as a guide. Timings may vary due to temperature of food, thickness, type and your own preference of cooking.
- i** Maximum load capacity of oven tray: 4 kg (8.8 lb).
- i** 1st rack of the oven is the **bottom** rack.
- Do not place cookware with rough bases on the oven door.
- Ensure that there is at least 25mm space at top of oven when cooking larger foods or using taller cookware.

Baking and roasting

Food	Cooking level number	Rack position	Temperature (°C)	Cooking time
Fruit pies	One level	1	175	25...35 min.
Pizza	One level	1	200	15...20 min. depending on thickness
Small cakes	One level	1	160...170	25...35 min.
Victoria sandwich	One level	1	160...170	20...40 min.
Biscuits	One level	1	160...170	15...30 min.
Scones	One level	1	190	20...30 min.
Casseroles	One level	1	160	2...3 hours
Whole fish	One level	1	180	25...35 min.
Pasta bake	One level	1	170...180	20...40 min.
Roast Beef	One level	1	160...170	20...40 min. per 450 g + 15 min.

How to operate the top grill

-  Hot surfaces may cause burns! Keep children away from the product.
Oven door remains slightly inclined when opened full and thus, possible splashes to not reach you.

 **This product is designed for OPEN DOOR GRILLING.**

The grill oven can be used as grill or as baking oven. The oven door operates a door switch switching between grill and oven operation.

There is a switch on the door. As a safety precaution, this switch prevents operation of the grill when the door is CLOSED.

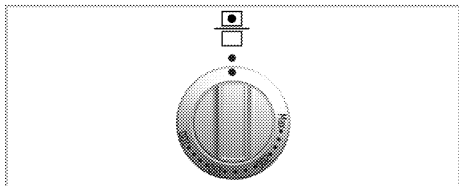

Switching on the grill

1. Open grill/ oven door.
2. Set grill temperature to 150°C and preheat for around 5 minutes, if it is necessary.
3. Then set desired grill temperature.
» Temperature light turns on.

Top oven cooking times table for grilling

Grilling with electric grill

-  1st rack of the oven is the **bottom** rack.

Food	Insertion level	Grilling time (approx.) #
Fish	1	20...25 min. #
Sliced chicken	1	25...35 min.
Lamb chops	1	20...25 min.
Roast beef	1	25...30 min. #
Veal chops	1	25...30 min. #
Toast bread	2	1...3 min.

depending on thickness

Turning off the grill oven

1. Turn the Grill control knob counterclockwise to Off (upper) position.
 - Put big or medium-sized portions in correct rack position under the grill heater for grilling.
 - For food only whose top is required to be roasted, grill the food either by placing onto the wire grill in the tray or by placing the tray onto the floor of grilling compartment.
 - Food and plates placed onto the floor of grill compartment will get heated when the main oven is in use. Do not switch on the grill compartment when using it for storing food.



Foods that are not suitable for grilling carry the risk of fire. Only grill food which is suitable for intensive grilling heat.

Do not place the food too far in the back of the grill. This is the hottest area and fatty food may catch fire.



While cooking is in progress, when the electricity is cut and comes back again, the top oven continues to operate. In case of any power failure, make sure to turn off the oven.

7 Maintenance and care

General information

Service life of the product will extend and the possibility of problems will decrease if the product is cleaned at regular intervals.



Disconnect the product from mains supply before starting maintenance and cleaning works.

There is the risk of electric shock!



Allow the product to cool down before you clean it.

Hot surfaces may cause burns!

- Clean the product thoroughly after each use. In this way it will be possible to remove cooking residues more easily, thus avoiding these from burning the next time the appliance is used.
- No special cleaning agents are required for cleaning the product. Use warm water with washing liquid, a soft cloth or sponge to clean the product and wipe it with a dry cloth.
- Always ensure any excess liquid is thoroughly wiped off after cleaning and any spillage is immediately wiped dry.
- Do not use cleaning agents that contain acid or chloride to clean the stainless or inox surfaces and the handle. Use a soft cloth with a liquid detergent (not abrasive) to wipe those parts clean, paying attention to sweep in one direction.



The surface might get damaged by some detergents or cleaning materials.

Do not use aggressive detergents, cleaning powders/creams or any sharp objects during cleaning.

Do not use harsh abrasive cleaners or sharp metal scrapers to clean the oven door glass since they can scratch the surface, which may result in shattering of the glass.



Do not use steam cleaners to clean the appliance as this may cause an electric shock.

Cleaning the hob

Glass ceramic surface

Wipe the glass ceramic surface (vitroceramic) with cold water, paying attention to leave no residual cleaning agents, and dry with a soft clothing. Residues may cause damage on the glass ceramic surface when using the hob for the next time.

Dried residues on the glass ceramic surface (vitroceramic) should under no circumstances be scraped with hook blades, steel wool or similar tools. Remove calcium stains (yellow stains) with commercially available lime remover or a small amount of lime remover such as vinegar or lemon juice. If the surface is heavily soiled, apply the cleaning agent on a sponge and wait until it is absorbed well. Then, clean the surface of the hob with a damp cloth.

- i** Sugar-based foods such as thick cream and syrup must be cleaned promptly without waiting the surface to cool down. Otherwise, glass ceramic surface may get damaged permanently.

Slight color fading may occur on coatings or other surfaces in time. This does not affect the operation of the product.

Color fading and stains on the glass ceramic surface is a normal condition, and not a defect.

Cleaning the control panel

Clean the control panel and knobs with a damp cloth and wipe them dry.

- i** If your product is equipped with buttons/knobs do not remove the control buttons/knobs to clean the control panel. Control panel may get damaged!

Cleaning the oven

To clean the side wall (Varies depending on the product model.)

(This feature is optional. It may not exist on your product.)

1. Remove the front section of the side rack by pulling it in the opposite direction of the side wall.
2. Remove the side rack completely by pulling it towards you.

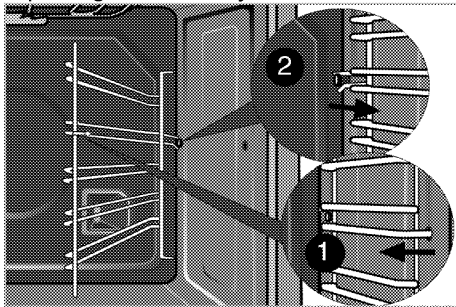

Catalytic walls

(This feature is optional. It may not exist on your product.)

The inner side walls (A) and/or the rear wall (B) of your product may be coated with catalytic enamel. Catalytic walls have a light matte colour and a porous surface. Catalytic walls of the oven should not be cleaned. Thanks to their perforated structure, catalytic surfaces absorb grease and once the surface is filled with grease, they start to shine. In this case, it is recommended to replace the parts.

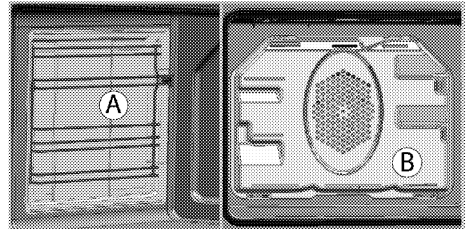

Easy Steam Cleaning

It ensures easy cleaning because the dirt (having waited not for too long) is softened with the steam that forms inside the oven and the water drops condensing on the inner surfaces of the oven.

1. Remove all accessories inside the oven.
2. Pour 500 ml of water into the oven tray and place the tray at the 2nd rack of the oven.

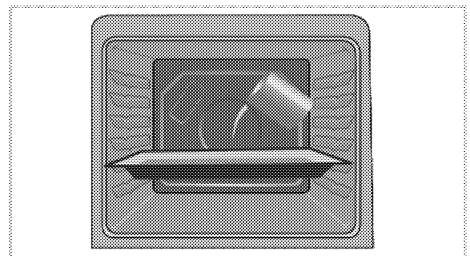

3. Set the oven at easy steam cleaning mode/ 100°C for 25 minutes.
4. Open the door and wipe the inner surfaces of the oven with a damp sponge or cloth.

- Use warm water with washing liquid, a soft cloth or sponge to clean the persistent dirt and wipe it with a dry cloth.

i During the easy steam cleaning mode, water that is placed in the tray to soften lightly formed residues/dirt within the oven cavity will evaporate and condense in the oven cavity and inner glass of the oven door, therefore water may drip when the oven door is opened. Wipe away the condensation as soon as the oven door is opened.

Clean oven door

To clean the oven door, use warm water with washing liquid, a soft cloth or sponge to clean the product and wipe it with a dry cloth.

Wipe the glass with vinegar and then rinse it against lime residues that may occur on the oven glass.

i Don't use any harsh abrasive cleaners or sharp metal scrapers for cleaning the oven door. They could scratch the surface and destroy the glass.

Cleaning the oven door

i Do not use harsh abrasive cleaners, metal scrapers, wire wool or bleach materials to clean the oven door and glass.

You can remove your oven door and door glasses to clean them. How to remove the doors and windows is explained in the sections "Removing the oven door" and "Removing the inner glasses of the door". After removing the door inner glasses, clean them using a dishwashing detergent, warm

water and a soft cloth or sponge and dry them with a dry cloth. Wipe the glass with vinegar and then rinse it against lime residues that may occur on the oven glass.

Removing the top oven door

- Open the front door (1).
- Open the clips at the hinge housing (2) on the right and left hand sides of the front door by pressing them down as illustrated in the figure.

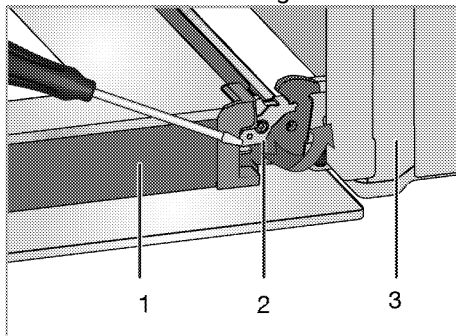

- Door
- Hinge lock(closed position)
- Oven
- Hinge lock(open position)

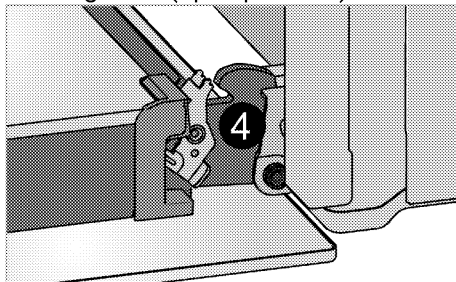

- Move the front door to half-way.

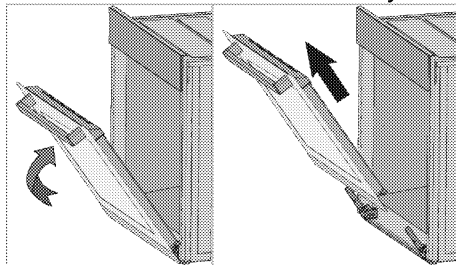

4. Remove the front door by pulling it upwards to release it from the right and left hinges.

i Steps carried out during removing process should be performed in reverse order to install the door. Do not forget to close the clips at the hinge housing when reinstalling the door.

Removing the door inner glass (This feature is optional. It may not exist on your product.)

The inner glass panel of the oven door at upper oven can be removed for cleaning.

1. Open the oven door.

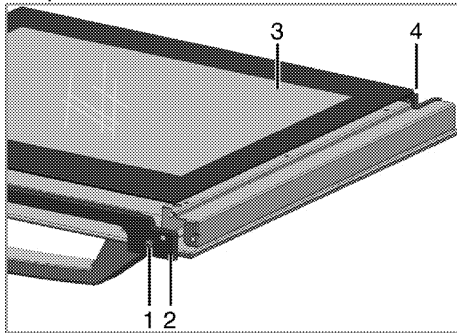

- 1 Screw
- 2 Profile
- 3 Inner glass pane
- 4 Plastic slot

2. Take out the screw (1) with a screwdriver

3. Take out the profile (2) than hold up to inner glass (3).

4. Then group the door again, put the glass pane (3) to the plastic slots (4) and group the profile.

i If the oven door has three glasses, be sure to reattach the inner glass panel.

Replacing the oven lamp

! Before replacing the oven lamp, make sure that the product is disconnected from mains and cooled down in order to avoid the risk of an electrical shock. Hot surfaces may cause burns!

i In this oven, an incandescent lamp with a power of less than 40 W, a height of less than 60 mm, a diameter of less than 30 mm or a halogen lamp with socket type G9, a power of less than 60 W is used. The lamps are suitable for operation at temperatures above 300 °C. Oven lamps can be obtained from Authorised Service Agents or technician with licence. This product contains a lamp of electric class G.

i The oven lamp is a special electric light bulb that can resist up to 300 °C. See *Technical specifications, page 14* for details. Oven lamps can be obtained from Authorised Service Agents or technician with licence.

i Position of lamp might vary from the figure.

i The lamp used in this appliance is not suitable for household room illumination. The intended purpose of this lamp is to assist the user to see foodstuffs.

i The lamps used in this appliance have to withstand extreme physical conditions such as temperatures above 50 °C.

If your oven is equipped with a round lamp:

1. Disconnect the product from mains.
2. Turn the glass cover counter clockwise to remove it.

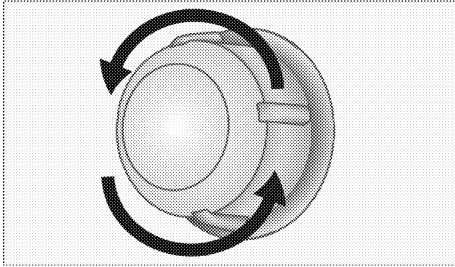

3. If your oven lamp is of type (A) shown in the figure below, remove it by rotating as shown and replace it. If it is of type (B), pull and remove it as shown in the figure and replace it.

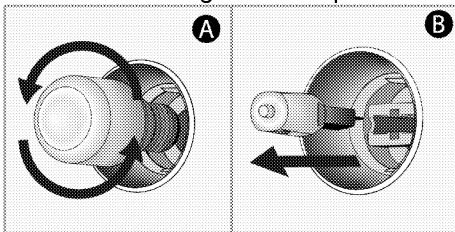

3. Install the glass cover.

8 Troubleshooting

Oven emits steam when it is in use.

- It is normal that steam escapes during operation. >>> *This is not a fault.*

Product emits metal noises while heating and cooling.

- When the metal parts are heated, they may expand and cause noise. >>> *This is not a fault.*

Product does not operate.

- The mains fuse is defective or has tripped. >>> *Check fuses in the fuse box. If necessary, replace or reset them.*
- Product is not plugged into the (grounded) socket. >>> *Check the plug connection.*
- If the display does not light up when you switch the hob on again. >>> *Disconnect the appliance at the circuit breaker. Wait 20 seconds and then reconnect it.*
- Overheat protection is active. >>> *Allow your hob to cool down.*
- The cooking pot is not suitable. >>> *Check your pot.*

Oven light does not work.

- Oven lamp is defective. >>> *Replace oven lamp.*
- Power is cut. >>> *Check if there is power. Check the fuses in the fuse box. If necessary, replace or reset the fuses.*

Oven does not heat.

- Might not be set to a certain cooking function and/or temperature. >>> *Set the oven to a certain cooking function and/or temperature.*
- In models equipped with a timer, the timer is not adjusted. >>> *Adjust the time.* (In products with microwave oven, timer controls only microwave oven.)
- Power is cut. >>> *Check if there is power. Check the fuses in the fuse box. If necessary, replace or reset the fuses.*

"E" symbol appears on the cooking zone display.

- You have not placed the pot on the active cooking zone. >>> *Check if there is a pot on the cooking zone.*
- Your pot is not compatible with induction cooking. >>> *Check if your cooking pot is compatible with induction hob.*
- The cooking pot is not centered properly or the bottom surface of the pot is not wide enough for the cooking zone. >>> *Choose a pot wide enough and center the pot on the cooking zone properly.*
- Cooking pot or cooking zone is overheated. >>> *Allow them to cool down.*

Selected cooking zone suddenly turns off during operation.

- Cooking time for the selected cooking zone may be over. >>> *You may set a new cooking time or finish cooking.*
- Overheat protection is active. >>> *Allow your hob to cool down.*
- An object may be covering the touch control panel. >>> *Remove the object on the panel.*

The pot does not get warm even if the cooking zone is on.

- Your pot is not compatible with induction cooking. >>> Check if your cooking pot is compatible with induction hob.
- The cooking pot is not centered properly or the bottom surface of the pot is not wide enough for the cooking zone. >>> Choose a pot wide enough and center the pot on the cooking zone properly.

(In models with timer) Clock display is blinking or clock symbol is on.

- A previous power outage has occurred. >>> *Adjust the time / Switch of the product and switch it on again.*

Noise from the hob during cooking

Some sounds may be heard from the cooker while cooking. These sounds are due to the composition of the cooking vessel. These sounds are normal, they are not a malfunction and they are a part of induction technology.

Possible noises and reasons

- **Fan noise:** The cooker is equipped with a fan that activates automatically according to the temperature of the appliance. The fan has various operating levels and operates at different levels as per the temperature.
- **Lower buzz like the operating noise of a transformer:** This is due to the nature of the induction technology. As the heat is transmitted directly to the base of the cooking vessel, such buzz sounds may be heard as per the material of the cooking vessel. Thus, different noises may be heard with different cookware.
- **Cracking noise:** The reason of this is the structure and material of the base of the cooking vessel. A cracking sound may be heard if the cooking vessel is made of various layers with different materials.
- **Whining noise:** A whining sound may be heard when two cooking zones on the same side of the cooker are used to cook with different cooking levels.

i Consult the Authorised Service Agent or technician with licence or the dealer where you have purchased the product if you can not remedy the trouble although you have implemented the instructions in this section. Never attempt to repair a defective product yourself.

Error codes/reasons for hob control unit and possible solutions

Error codes	Error reasons	Possible solutions
E 22 E 26	Induction hob is overheated.	Turn the induction cooker off and wait until it is cooled down. The error shall be resolved when temperature of the hob comes down below the limits.
E 46	One or more keys are kept pressed for more than 10 seconds. An object is left on the control panel or the control is exposed to vapour.	The problem shall be resolved when you remove your hand from the hob. The problem shall be resolved when the control panel is cleaned.
E 47	A pot suitable for induction heating is not used.	The error shall be resolved when a pot suitable for induction heating is used.
E 1 - E 15	Communication error on induction hob.	Turn the induction hob off and operate again after 30 seconds. Contact the authorized dealership if the issue is resumed.
E 16 - E 21	Temperature sensor error on induction hob.	Turn the induction hob off and operate again after 30 seconds. Contact the authorized dealership if the issue is resumed.
E 23 E 24	Software error on induction hob.	Turn the induction hob off and operate again after 30 seconds. Contact the authorized dealership if the issue is resumed.
E 25	Fan operation error on induction hob.	Turn the induction hob off and operate again after 30 seconds. Contact the authorized dealership if the issue is resumed.
E 31 - E 45	Electronic board hardware error on induction hob.	Turn the induction hob off and operate again after 30 seconds. Contact the authorized dealership if the issue is resumed.
E 48 E 49 E 51	Sensor error on induction hob.	Sensor equipment shall be rendered compatible for the operating conditions. Contact the authorized dealership if the issue is resumed.
E 52 - E 57	High temperature error on induction hob.	Turn the induction hob off and wait until it is cooled down. The error shall be resolved when temperature of the sensor comes down below the limits. Contact the authorized dealership if the issue is resumed.

9 Guarantee Details

BLOMBERG UK AND IRELAND STANDARD MANUFACTURER GUARANTEE TERMS AND CONDITIONS

Your new Blomberg product is guaranteed against faulty materials, defective components or manufacturing defects.

The standard guarantee starts from the date of original purchase of the product, and lasts for a period of thirty six (36) months unless Beko plc (the “Manufacturer”) agrees to extend the guarantee for the product in writing.

If you have any questions about the guarantee on your product (including how long it is valid), please contact your retailer or our contact centre on **0333 207 9870** (UK and Northern Ireland) or **01 691 0160** (Republic of Ireland)

This guarantee does not in any way diminish or affect your statutory rights in connection with the product. This guarantee is in addition to your statutory rights as a consumer. If you have any questions about these rights, please contact the retailer from which you purchased the product. In certain circumstances, it is possible that your statutory rights may offer additional or higher levels of protection than those offered under the terms of this guarantee.

What is covered by this guarantee?

- Repairs to the product required as a result of faulty materials, defective components or manufacturing defects.
- Functional replacement parts to repair a product.
- The costs of a Blomberg Approved Engineer to carry out the repair.

What is not covered?

- Transit and delivery damage.
- Cabinet or appearance parts, including but not limited to control knobs, flaps and handles.
- Accessories and/or consumable items including but not limited to ice trays, scrapers, cutlery baskets, filters and light bulbs.
- Repairs necessary as a direct or indirect result of:
 - Accidental damage, misuse or abuse of a product.
 - An attempted repair of a product by anyone other than a Blomberg Approved Engineer (the “Engineer”).

Envelope IV

- Installation or use of a product where such installation or use fails to meet the requirements contained in this guarantee or the User Instructions Booklet.
- Repairs to a product operated at any time on commercial or non-residential household premises (unless we have previously agreed to the installation environment).

This guarantee is limited to the cost of repairing the product. To the extent permitted by law, the Manufacturer does not accept and will not be held liable for any financial loss incurred in connection with the failure of any product to operate in accordance with the expected standards. Such financial loss includes but is not limited to loss arising from:

- Time taken off work.
- Damaged food, clothing or other items.
- Meals taken at restaurants or from takeaways.
- General compensation for inconvenience.

Important Notes

1. Your product is designed and built for domestic household use only.
2. The guarantee will automatically be void if the product is installed or is used in commercial or non-residential domestic household premises, unless we have previously agreed to the installation environment.
3. The product must be correctly installed, located and operated in accordance with the instructions contained in the User Instructions Booklet provided with your product.
4. Professional installation by a qualified Electrical Domestic Appliance Installer is recommended for all Washing Machines, Dishwashers and Electric Cookers (as incorrect installation may result in you having to pay for the cost of repairing the product).
5. Gas Cookers must be professionally installed by a Gas Safe (or Gas Networks Ireland for Republic of Ireland) registered gas installer.
6. This guarantee is given in respect of products purchased and used within the United Kingdom and the Republic of Ireland.

Envelope IV

7. This guarantee is effective from the initial date of purchase of a new product from an authorised retailer and will be void if the product is resold.
8. This guarantee does not apply to graded sales (where the product is purchased as a “second”).
9. Possession of a copy of these terms and conditions does not necessarily mean that a product has the benefit of this guarantee. If you have any questions, please call our Call Centre on the number set out above.
10. The Manufacturer reserves the right to terminate the guarantee if its staff or representatives are subjected to physical or verbal abuse in the course of carrying out their duties.
11. Optional extras, where available (i.e. extendable feet) are supplied on a chargeable basis only.

Does Blomberg offer replacements?

This is a repair-only guarantee. On occasion, the Manufacturer may at its sole discretion, replace your product with a new product instead of carrying out a repair. Where a replacement is offered, this would normally be an identical model but when this is not possible, a model of similar specification will be provided. The Manufacturer will cover the costs and arrange for the delivery of the new product and for the return of the old product. Any costs related to disconnecting the faulty product and installing the replacement product will not be borne by the Manufacturer unless previously agreed to in writing. The original guarantee will continue to apply to the replacement product; the new product will not come with a new guarantee.

Envelope IV

When will the repair take place?

Our Engineers work Monday to Friday 9.00am to 5.00pm. Appointments outside these hours may be possible at the sole discretion of the Manufacturer but cannot be guaranteed. Whilst our Engineers will endeavour to minimize inconvenience and to meet requests for specific timed appointments, this cannot be guaranteed. We will not be liable for delays or if it is unable to carry out a repair because a convenient appointment cannot be arranged.

Will there be any charge for the repairs?

It is your responsibility to provide evidence to the Engineer that your product is covered by this guarantee with a proof of purchase. The Manufacturer reserves the right to charge for the reasonable cost of any service call if:

- You cannot provide evidence that your product is covered by this guarantee.
- Where a service call has been made and the engineer finds that there is no fault with your product.
- That your product has not been installed or operated in accordance with the User Instructions Booklet.
- That the fault was caused by something other than faulty materials, defective components or manufacturing defects.
- For missed appointments.

Payment of these costs are due immediately upon the Engineer providing you with an invoice. The Manufacturer reserves the right to terminate the guarantee if you fail to pay the costs for the service call in a timely manner.

If you are a resident of the United Kingdom, this guarantee will be governed by English law and subject to the English Courts, save where you live in another part of the United Kingdom, in which case the law and courts of that location will apply.

If you are resident in the Republic of Ireland, this guarantee will be governed by Irish law and the Irish courts will have jurisdiction.

This guarantee is provided by Beko plc. Beko House, 1 Greenhill Crescent, Watford, Hertfordshire. WD18 8QU.

Beko plc is registered in England and Wales with company registration number 02415578.

Envelope IV

BLOMBERG UK AND IRELAND OPTIMA INVERTER MOTOR GUARANTEE TERMS AND CONDITIONS

This 10 year guarantee relates to Blomberg products that feature the Optima Inverter Motor.

The Optima Motor guarantee terms and conditions are in addition to our Standard guarantee terms and conditions detailed in the previous section.

In order to activate the 10 year guarantee you MUST register the appliance within 90 days of the original purchase date. You can register by first visiting blomberguk.com/register and by following the online instructions.

All Blomberg appliances come with a 3 year parts and labour guarantee as standard. When you register your appliance for the Optima Inverter Motor 10 year guarantee, you are also registering your appliance for the standard 3 year parts and labour guarantee.

Blomberg built-in or integrated products purchased from Euronics agents come with a 3 year parts and labour guarantee which is extended to 5 years, free of charge, upon registration of the appliance. When you register your appliance for this additional 2 years, you will automatically activate the Optima Inverter Motor 10 year guarantee. You do not need to register twice. To make a claim against your Blomberg Optima Inverter Motor Guarantee (the "Guarantee"), all customer and product details must be registered with Beko plc using the procedure outlined below.

1. This extra 7 years or 5 years (for built-in appliances from Euronics agents) Guarantee is only effective after the expiration of the standard manufacturer's guarantee.
2. It is only valid for the Optima Inverter motors of selected washing machines, washer-dryers, tumble dryers and dishwashers. It does not cover any labour charge or any other components of the product. In addition, it is only valid for one replacement of the Optima motor during the extra 9-year (for free standing appliances) or 8 year (for built-in appliances) guarantee period.

Envelope IV

3. To activate your guarantee, you MUST register your appliance within 90 days of the original purchase date, by visiting blomberguk.com/register.
4. Customers will receive a unique reference code as proof of guarantee validation by email or post, which must be quoted at the time of a claim being made.
5. Any repair/replacement of the Optima Inverter motor must only be carried out by an authorised Blomberg Service Agent (the "Service Agent").
6. Labour for the repair/replacement of the Optima Inverter motor is not included in this guarantee and is chargeable directly by the Service Agent.
7. Any additional components fitted to the product at any time will not be covered by this guarantee and will be chargeable directly by the Service Agent.
8. The guarantee is not transferable and cannot be exchanged for cash.
9. There are no alternative or additional offers to this Guarantee.
10. The guarantee is exclusive of the manufacturer's standard guarantee
11. The Terms and Conditions shown above are in addition to the standard terms and conditions of your product guarantee. Please read and refer to such Terms and Conditions when making any claim.
12. We may use the information you provide for marketing purposes and to analyse your purchasing preferences. We may keep your information for a reasonable period for these purposes in accor-

Envelope IV

dance with the applicable Data Protection Laws and General Data Protection Regulations (GDPR). You can opt into this service during the registration process. Further details are available at <http://www.blomberguk.com/cookie-and-privacy>.

13. These Terms and Conditions are governed by the laws of England and Wales; manufacturer: Beko plc, Beko House, 1 Greenhill Crescent, Watford WD18 8QU. Company Registration Number: 02415578.

Envelope IV

HOW TO OBTAIN SERVICE FOR YOUR APPLIANCE

Please keep your purchase receipt or other proof of purchase details in a safe place; you will need to have this documentation available should the product require attention under guarantee.

Please take a few moments to complete the details below, as you will need this information when you call us, or to use our online services. When you call us you may be required to input your serial number into your telephone keypad. For help please visit Blomberguk.com/support/model-finder

- The product model number is printed on the Operating Instruction Booklet / User guide
- The product model and serial number is printed on the Rating Label affixed to the appliance.
- The Retailer (Purchased from) and Date of purchase will be printed on your purchase receipt or other proof of purchase paperwork

Recording of these details alone will not count as proof of purchase. A valid proof of purchase is required for requesting service under guarantee.

Model number	Serial number	Purchased from	Date of purchase

For service under guarantee or for product advice please call our Contact centre

Before requesting service please check the troubleshooting guide in the Operating Instructions booklet, as a charge may be levied where no fault is found, and even though your product may still be under guarantee.

After arranging service the area around the product must be easily accessible to the Engineer, without the need for cabinets or furniture to be removed or moved.

It is your responsibility to ensure our Engineers have a clean and safe environment to carry out any repairs.

Please have your Model number and Serial number available when you call us, as you may be required to input your serial number into your telephone keypad during your call.

Envelope IV

UK Mainland & Northern Ireland:

0333 207 9870

Landline or mobile calls to 0333 numbers cost no more than calls to geographic numbers 01 or 02, and are charged at the basic rate. Calls from landlines and mobiles are included in free call packages but please check with your telephone service provider for exact call charges.

Envelope IV

Republic of Ireland:

01 691 0160

Service once the manufacturers guarantee has expired

If you have purchased an extended guarantee please refer to the instructions contained within the extended guarantee agreement document, otherwise please call us using the appropriate number above, where service can be obtained at a charge.

Should you experience any difficulty in obtaining service please call us on **0333 207 9870** or **01 691 0160**

Contact us through our website

Send us a secure message through our online contact us form. Please visit our website, click Contact Us and choose a product support topic from the list of options. Complete the required details and click send message.

Product registrations

For UK and Republic of Ireland product registrations please visit blomberguk.com/register

