

SAMSUNG

User guide

HW-B400F

Thank you for purchasing this Samsung product.









To receive more complete service, please register your product at www.samsung.com

SAFETY INFORMATION

SAFETY WARNINGS

TO REDUCE THE RISK OF ELECTRIC SHOCK, DO NOT REMOVE THE COVER (OR BACK). NO USER-SERVICEABLE PARTS ARE INSIDE. REFER SERVICING TO QUALIFIED SERVICE PERSONNEL.

Refer to the table below for an explanation of symbols which may be on your Samsung product.

	<p style="text-align: center;">CAUTION RISK OF ELECTRIC SHOCK. DO NOT OPEN.</p>	
	<p>This symbol indicates that high voltage is present inside. It is dangerous to make any kind of contact with any internal part of this product.</p>	
	<p>This symbol indicates that this product has included important literature concerning operation and maintenance.</p>	
	<p>Class II product : This symbol indicates that it does not require a safety connection to electrical earth (ground). If this symbol is not present on a product with a power cord, the product MUST have a reliable connection to protective earth (ground).</p>	
	<p>AC voltage : This symbol indicates that the rated voltage marked with the symbol is AC voltage.</p>	
	<p>DC voltage : This symbol indicates that the rated voltage marked with the symbol is DC voltage.</p>	
	<p>Caution, Consult instructions for use : This symbol instructs the user to consult the user manual for further safety related information.</p>	

WARNING

- To reduce the risk of fire or electric shock, do not expose this appliance to rain or moisture.
- Do not use liquid fumigators containing chemicals, such as mosquito repellent or air freshener, around the product. If steam comes in contact with the product surface or enters the product, it may cause stains or malfunction.

CAUTION

- TO PREVENT ELECTRIC SHOCK, MATCH WIDE BLADE OF PLUG TO WIDE SLOT, FULLY INSERT.
- This apparatus shall always be connected to a AC outlet with a protective grounding connection.
- To disconnect the apparatus from the mains, the plug must be pulled out from the mains socket, therefore the mains plug shall be readily operable.
- Do not expose this apparatus to dripping or splashing. Do not put objects filled with liquids, such as vases on the apparatus.
- To turn this apparatus off completely, you must pull the power plug out of the wall socket. Consequently, the power plug must be easily and readily accessible at all times.

Wiring the Main Power Supply Plug (UK Only)

IMPORTANT NOTICE

The mains lead on this equipment is supplied with a moulded plug incorporating a fuse. The value of the fuse is indicated on the pin face of the plug and if it requires replacing, a fuse approved to BS1362 of the same rating must be used. Never use the plug with the fuse cover removed. If the cover is detachable and a replacement is required, it must be of the same colour as the fuse fitted in the plug. Replacement covers are available from your dealer. If the fitted plug is not suitable for the power points in your house or the cable is not long enough to reach a power point, you should obtain a suitable safety approved extension lead or consult your dealer for assistance.

However, if there is no alternative to cutting off the plug, remove the fuse and then safely dispose of the plug. Do not connect the plug to a mains socket as there is a risk of shock hazard from the bared flexible cord. Never attempt to insert bare wires directly into a mains socket. A plug and fuse must be used at all times.

IMPORTANT

The wires in the mains lead are coloured in accordance with the following code:– BLUE = NEUTRAL BROWN = LIVE As these colours may not correspond to the coloured markings identifying the terminals in your plug, proceed as follows:– The wire coloured BLUE must be connected to the terminal marked with the letter N or coloured BLUE or BLACK. The wire coloured BROWN must be connected to the terminal marked with the letter L or coloured BROWN or RED.

WARNING : DO NOT CONNECT EITHER WIRE TO THE EARTH TERMINAL WHICH IS MARKED WITH THE LETTER E OR BY THE EARTH SYMBOL , OR COLOURED GREEN OR GREEN AND YELLOW.

PRECAUTIONS

1. Ensure that the AC power supply in your house complies with the power requirements listed on the identification sticker located on the bottom of your product. Install your product horizontally, on a suitable base (furniture), with enough space around it for ventilation (7-10 cm). Make sure the ventilation slots are not covered. Do not place the unit on amplifiers or other equipment which may become hot. This unit is designed for continuous use. To fully turn off the unit, disconnect the AC plug from the wall outlet. Unplug the unit if you intend to leave it unused for a long period of time.

2. During thunderstorms, disconnect the AC plug from the wall outlet. Voltage peaks due to lightning could damage the unit.
 3. Do not expose the unit to direct sunlight or other heat sources. This could lead to overheating and cause the unit to malfunction.
 4. Protect the product from moisture (i.e. vases), and excess heat (e.g. a fireplace) or equipment creating strong magnetic or electric fields. Unplug the power cable from the AC wall socket if the unit malfunctions. Your product is not intended for industrial use. It is for personal use only. Condensation may occur if your product has been stored in cold temperatures. If transporting the unit during the winter, wait approximately 2 hours or until the unit has reached room temperature before using.
 5. The battery used with this product contains chemicals that are harmful to the environment. Do not dispose of the battery in the general household trash. Do not expose the battery to excess heat, direct sunlight, or fire. Do not short circuit, disassemble, or overheat the battery.
- CAUTION :** Danger of explosion if the battery is replaced incorrectly. Replace only with the same or equivalent type.

CONTENTS

01	Checking the Components	6
02	Product Overview	7
	Top Panel of the Soundbar	7
	Bottom Panel of the Soundbar	8
03	Using the Remote Control	9
	Inserting Batteries before using the Remote Control (AAA batteries X 2)	9
	How to Use the Remote Control	9
	Using the Hidden Buttons (Buttons with more than one function)	14
	Output specifications for the different sound effect modes	14
	Adjusting the Soundbar volume with a TV remote control	15
04	Connecting the Soundbar	16
	Connecting Electrical Power	16
05	Using a wired connection to the TV	17
	Method 1. Connecting a TV using an HDMI Cable	17
	Method 2. Connecting using an Optical Cable	19
06	Using a wireless connection to the TV	20
	Connecting via Bluetooth	20

07	Connecting an External Device	22
	Connecting using an Optical Cable	22
08	Connecting a USB Storage Device	23
09	Connecting a Mobile Device	24
	Connecting via Bluetooth	24
	Connecting a Soundbar to a mobile device via NFC function	27
10	Installing the Wall Mount (Optional)	28
	Installation Precautions	28
	Wall mount Components	28
11	Software Update	31
	Reset	32
12	Troubleshooting	33
13	Licences & Other Information	34
14	Important Notes About Service	35
15	Specifications and Guide	36
	Specifications	36

01 CHECKING THE COMPONENTS

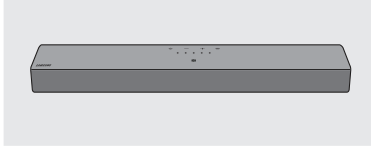

Soundbar Main Unit



Power Cord (Soundbar)











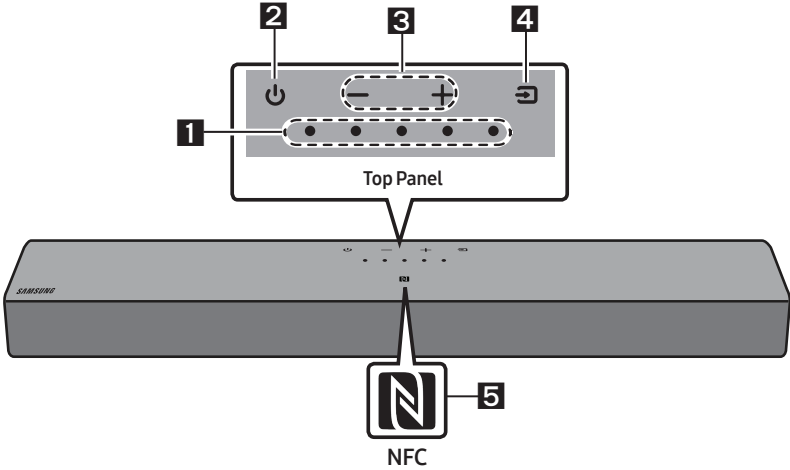















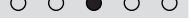

**Soundbar Remote Control /
Batteries**

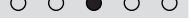

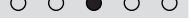



- For more information about the power supply and power consumption, refer to the label attached to the product. (Label: Bottom of the Soundbar Main Unit)
- To purchase additional components or optional cables, contact a Samsung Service Centre or Samsung Customer Care.
- Design, specifications are subject to change without prior notice.
- The appearance of the accessories may differ slightly from the illustrations above.

02 PRODUCT OVERVIEW

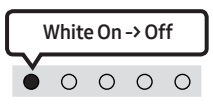
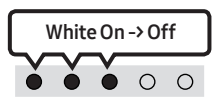
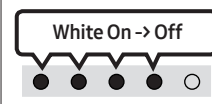
Top Panel of the Soundbar

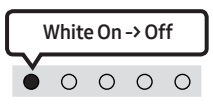
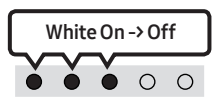
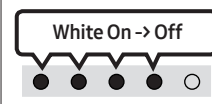

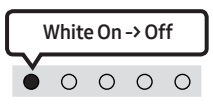
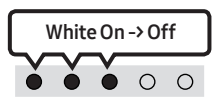
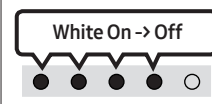
<p>1</p>	<p>LED indicator</p>	<p>The LED Indicator flashes, glows, or changes colour depending on the Soundbar's current mode or status. The colour of the LED indicator and the number of lights indicate the active mode as described below.</p> <table border="1" data-bbox="266 852 1025 933"> <tr> <td style="text-align: center;">  White LED </td> <td style="text-align: center;">  White LED </td> <td style="text-align: center;">  Multicolour LED </td> <td style="text-align: center;">  White LED </td> <td style="text-align: center;">  White LED </td> </tr> </table> <ul style="list-style-type: none"> The Multicolour LED changes to White, Cyan, Green, Red, Yellow, Orange, Purple and Blue depending on the mode or status. 	 White LED	 White LED	 Multicolour LED	 White LED	 White LED
 White LED	 White LED	 Multicolour LED	 White LED	 White LED			
<p>2</p>	<p>Power</p>	<p>Turns the power on and off.</p> <table border="1" data-bbox="266 1062 792 1201"> <tr> <td style="text-align: center;"> LED Indicator  On </td> <td style="text-align: center;"> LED Indicator  Off </td> </tr> </table>	LED Indicator  On	LED Indicator  Off			
LED Indicator  On	LED Indicator  Off						
<p>3</p>	<p>Volume</p>	<p>Adjusts the volume.</p> <table border="1" data-bbox="266 1262 1042 1425"> <tr> <td style="text-align: center;"> LED Indicator  Volume Up </td> <td style="text-align: center;"> LED Indicator  Volume Down </td> </tr> </table>	LED Indicator  Volume Up	LED Indicator  Volume Down			
LED Indicator  Volume Up	LED Indicator  Volume Down						

4	Source	<ul style="list-style-type: none"> Press the  (Source) button to change the mode. Each time you change the mode, the LED lights in white and then turns off. 						
		<table border="1"> <tr> <td>LED Indicator</td> <td></td> <td></td> <td></td> </tr> <tr> <td></td> <td>"TV ARC"</td> <td>"Bluetooth"</td> <td>"USB" or "Digital Audio In"</td> </tr> </table>	LED Indicator					"TV ARC"
LED Indicator								
	"TV ARC"	"Bluetooth"	"USB" or "Digital Audio In"					
5	NFC Logo	You can activate your Bluetooth connection by placing your phone in the NFC detection area of the Soundbar.						

- When you plug in the Power cord, the power button will begin working in 4 to 6 seconds.
- When you turn on this unit, there will be a 4 to 5 second delay before it produces sound.
- If you hear sounds from both the TV and Soundbar, go to the **Settings** menu for the TV audio and change the TV speaker to **External Speaker**.

Bottom Panel of the Soundbar

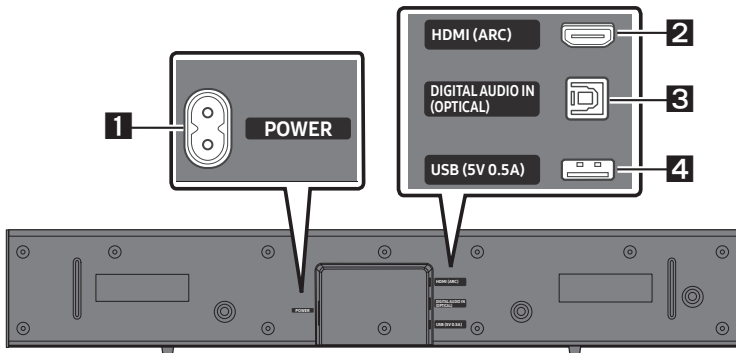

1	POWER Connect the Soundbar's AC power cable.
2	HDMI (ARC) Connect to the HDMI (ARC) port on a TV.
3	DIGITAL AUDIO IN (OPTICAL) Connect to the digital (optical) output of an external device.
4	USB (5V 0.5A) Connect a USB device here to play music files stored on the USB device through the Soundbar.

- Do not connect this unit or other components to an AC outlet until all connections between components are complete.

03 USING THE REMOTE CONTROL

Inserting Batteries before using the Remote Control (AAA batteries X 2)

Slide the back cover in the direction of the arrow until it is completely removed.

Insert 2 AAA batteries (1.5V) so that their orientation is correct. Slide the back cover back into position.

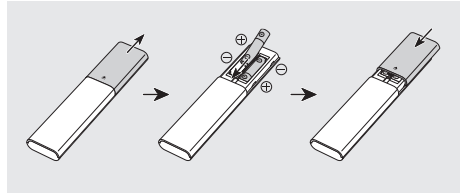

How to Use the Remote Control

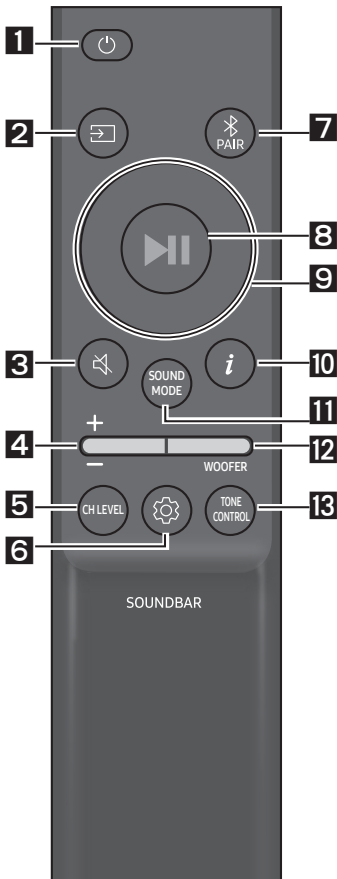

1

Power

Turns the Soundbar on and off.

LED Indicator	<div style="border: 1px solid black; padding: 2px; display: inline-block;">Cyan Blinks X1</div>	<div style="border: 1px solid black; padding: 2px; display: inline-block;">Red Blinks X3</div>
	<p style="text-align: center;">On</p>	<p style="text-align: center;">Off</p>

- Auto Power Down Function**

The unit turns off automatically in the following situations:

- In "TV ARC" / "Bluetooth" / "USB" or "Digital Audio In" mode if there is no audio signal for 18 minutes.

2

Source

Press to select a source connected to the Soundbar.

LED Indicator	<div style="border: 1px solid black; padding: 2px; display: inline-block;">White On -> Off</div>	<div style="border: 1px solid black; padding: 2px; display: inline-block;">White On -> Off</div>
	"TV ARC"	"Bluetooth"
LED Indicator	<div style="border: 1px solid black; padding: 2px; display: inline-block;">White On -> Off</div>	
	"USB" or "Digital Audio In"	

3

Press the (**Mute**) button to mute the sound.
Press it again to unmute the sound.

LED Indicator	
------------------	--

4**Volume**

Push the button up or down to adjust the volume.

LED Indicator		
------------------	--	--

5**CH LEVEL**

By pressing the button, you can adjust the volume of the each speaker.

LED Indicator	
	"Centre Level"

6 **(Sound Control)**





By pressing the button, you can set the audio function. The desired item can be adjusted using the **Up/Down** buttons. Each time the mode changes, the Multicolour LED blinks in white.

LED Indicator	
	"Sync" → "Night mode" → "Voice enhancement"

- If the video on the TV and audio from the Soundbar are not synchronised, select **"Sync"** in Sound Control, and then set the audio delay between 0~300 milliseconds by using the **Up/Down** buttons. (Not available in **"USB"** or **"Bluetooth"** mode.)
- **"Sync"** is only supported for some functions.
- **"Night mode"** is optimised for night time viewing with the settings adjusted to bring the volume down but keep the dialog clear.
- **"Voice enhancement"** makes it easier to hear spoken dialog in movies and TV.

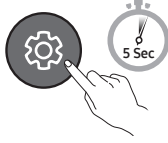
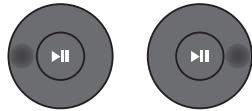
7 Band EQ

Press and hold the  (**Sound Control**) button for about 5 seconds to adjust the sound for each frequency band. 150Hz, 300Hz, 600Hz, 1.2kHz, 2.5kHz, 5kHz, and 10kHz are selectable using the **Left/Right** buttons and each can be adjusted to a setting between -6 to +6 using the **Up/Down** buttons. (Make sure the Sound mode is set to "**Standard**".)

7 Band EQ			
			
Press and hold the  (Sound Control) button for about 5 seconds.		Using the Left/Right buttons and each can be adjusted to setting between -6 to +6.	
	"150Hz"		"150Hz" → "300Hz" → "600Hz" → "1.2kHz" → "2.5kHz" → "5kHz" → "10kHz"

7

Bluetooth PAIR

Switch the Soundbar to Bluetooth pairing mode.

When you press the button, the LED display changes as shown below.

- Until pairing is complete, the Multicolour LED changes as **Red** → **Green** → **Blue** in turn.

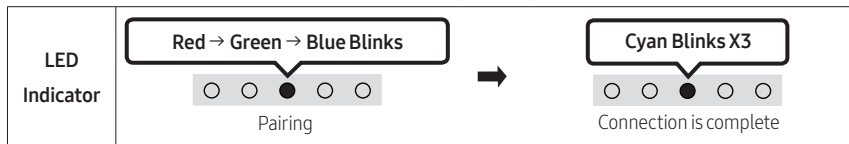

8

(Play / Pause)

You can also play or pause music by pressing the button in "**USB**" mode.

9

Up/Down/Left/Right

Press **Up/Down/Left/Right** on the button to select or set functions.

- **Repeat**

To use the Repeat function in "**USB**" mode, press the **Up** button.

- **Music Skip**

Press the **Right** button to select the next music file. Press the **Left** button to select the previous music file.

10



(Info)

Press the button to display information about the current function. (See page 8.)

11

SOUND MODE

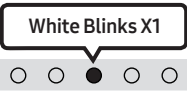
By pressing the button, you can select the desired audio mode. Each time the mode changes, the Multicolour LED blinks in white. (The sound mode may differ with the TV model.)

LED Indicator	
	"Standard" → "Surround"

- **Standard**
Outputs the original sound.
- **Surround**
Provides a wider sound field than standard.

- **Bluetooth Power On/Off**

This feature automatically turns the Soundbar on when it receives a connection request from a previously connected TV or Bluetooth device. The setting is On by default.

- Press and hold the **SOUND MODE** button for more than 5 seconds to turn off the Bluetooth Power function.

- **DRC (Dynamic Range Control) On/Off**

Lets you apply dynamic range control to Dolby Digital and DTS Digital tracks.

Press and hold the **SOUND MODE** button for more than 5 seconds while the Soundbar is powered off to turn DRC (Dynamic Range Control) on or off. With the DRC turned on, loud sound is reduced. (The sound may be distorted.)

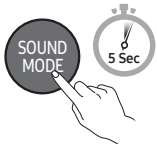
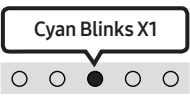
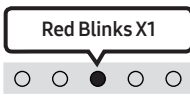
SOUND MODE button	LED Indicator	
	 On (Default)	 Off
DRC On/Off	Toggle On → Off	

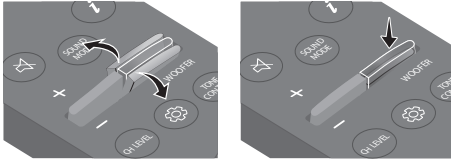
12**WOOFER (BASS) LEVEL**

Push the button up or down to adjust the bass level between -6 to +6. To set the woofer (bass) volume level to 0 (Default), press the button. (Subwoofer is not included.)

13**TONE CONTROL**

By pressing the button, you can adjust the volume of the treble or bass sound. The desired item can be adjusted using the **Up/Down** buttons. (This feature is available in all sound modes except **“Standard”** mode.)

LED Indicator	
	“Treble” → “Bass”

Using the Hidden Buttons (Buttons with more than one function)

Hidden Button		Reference page
Remote Control Button	Function	
WOOFER (Up)	TV remote control On/Off	page 15
Left	TV Auto connect On/Off	page 21
 (Sound Control)	7 Band EQ	page 11
SOUND MODE	DRC On/Off	page 12
	Bluetooth Power On/Off	page 12

Output specifications for the different sound effect modes

Effect	Input	Output
Standard	2.0 ch	2.0 ch
	5.1 ch	2.0 ch
Surround	2.0 ch	2.0 ch
	5.1 ch	2.0 ch

Adjusting the Soundbar volume with a TV remote control

Adjust the Soundbar volume using the TV's remote control.







- This function can be used with IR remote controls only. Bluetooth remote controls (remote controls that require pairing) are not supported.
- Set the TV speaker to **External Speaker** to use this function.
- Manufacturers supporting this function:
Samsung, VIZIO, LG, Sony, Sharp, PHILIPS, PANASONIC, TOSHIBA, Hisense, RCA

TV remote control On/Off

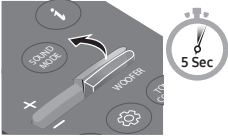
1. Turn Off the Soundbar.
2. Push up and hold the **WOOFER** button for 5 seconds.

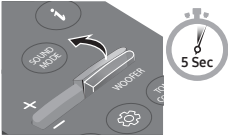
Each time you push the **WOOFER** button up and hold it for 5 seconds, the mode switches in the following order: "**Off-TV Remote**" (Default mode), "**Samsung-TV Remote**", "**All-TV Remote**".

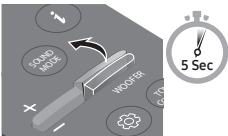
The LED indicator status changes each time the mode is changed, as shown below.

Remote Control Button	LED Indicator	Status
	<p>Red Blinks X1</p>  <p>"Off-TV Remote" (Default mode)</p>	Disable the TV remote control.
	<p>Cyan Blinks X1</p>  <p>"Samsung-TV Remote"</p>	Enable a Samsung TV's IR remote control.
	<p>Blue Blinks X1</p>  <p>"All-TV Remote"</p>	Enable a third-party TV's IR remote control.

04 CONNECTING THE SOUNDBAR

Connecting Electrical Power

Use the power components to connect the Soundbar to an electrical outlet in the following order:
Connect power cord End **A** to Soundbar and End **B** to wall socket.

- For more information about the required electrical power and power consumption, refer to the label attached to the product. (Label: Bottom of the Soundbar Main Unit)

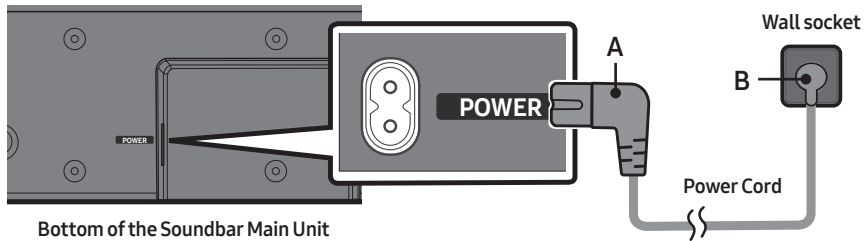

NOTE

- If you unplug and reconnect the power cord when the product is turned on, the Soundbar turns on automatically.

05 USING A WIRED CONNECTION TO THE TV

Method 1. Connecting a TV using an HDMI Cable

⚠ CAUTION

- When both the HDMI cable and optical cable are connected, the HDMI signal is received first.
- To connect the HDMI cable between the TV and Soundbar, be sure to connect the terminals marked ARC. Otherwise, the TV sound may not be output.
- The recommended cable is **High Speed HDMI Cable with Ethernet**.

Connecting the TV that supports HDMI ARC (Audio Return Channel)

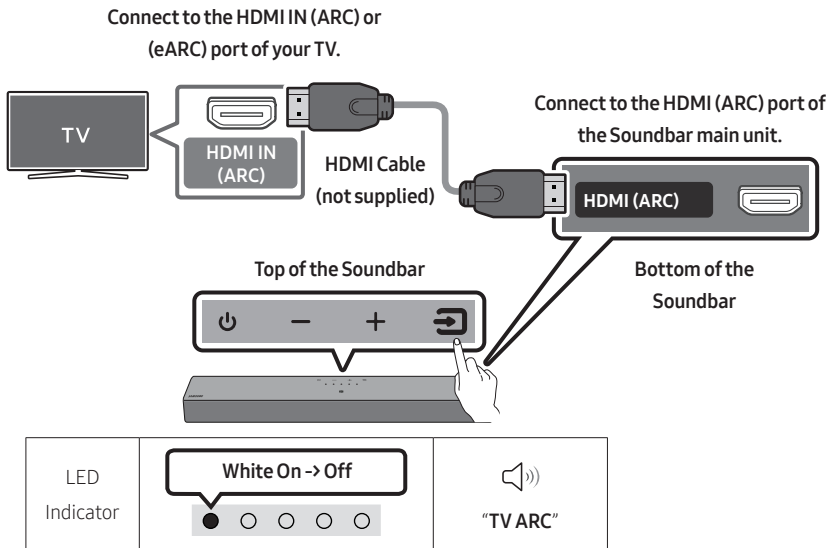

1. With the Soundbar and TV turned off, connect the HDMI Cable (not supplied) as shown in the figure.
2. Turn on the Soundbar and TV.
3. TV sound is output from the Soundbar.
 - When the sound is not output, check the HDMI Cable (not supplied) connection again.
 - Use the volume buttons on the TV's remote control to change the volume on the Soundbar.

NOTES

- When you connect the TV that supports the HDMI ARC (Audio Return Channel) to the Soundbar with an HDMI cable, you can transmit the digital video and audio data without connecting a separate optical cable.
- We recommend you use a coreless HDMI cable if possible. If you use a cored HDMI cable, use one whose diameter is less than 14 mm.
- This function is not available if the HDMI cable does not support ARC.
- When the audio in a broadcast is encoded in Dolby Digital and the “Digital Output Audio Format” on your TV is set to PCM, we recommend that you change the setting to Dolby Digital. When the setting on the TV is changed, you will experience better sound quality. (The TV menu may use different words for Dolby Digital and PCM depending on the TV manufacturer.)

Method 2. Connecting using an Optical Cable

Pre-connection Checklist

- When you use an optical cable and the terminals have covers, be sure to remove the covers.

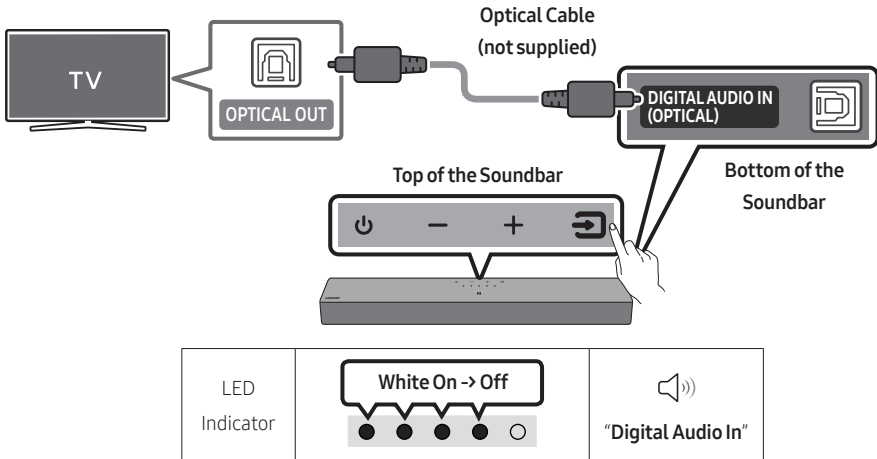

1. With the TV and Soundbar turned off, connect the **DIGITAL AUDIO IN (OPTICAL)** port on the Soundbar and the **OPTICAL** output port on the TV with the optical cable (not supplied), as shown in the figure.
2. Turn on the Soundbar and TV.
3. Press the  (**Source**) button on the top panel or remote control, and then select the "**Digital Audio In**" mode.
4. The TV sound is output from the Soundbar.

06 USING A WIRELESS CONNECTION TO THE TV

Connecting via Bluetooth

When a Samsung TV is connected using Bluetooth, you can hear stereo sound without the hassle of cables.

- Only one Samsung TV can be connected at a time.
- Samsung TV that supports Bluetooth can be connected.
Check the specifications of your TV.

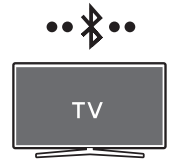

The initial connection

1. Press the **PAIR** button on the Soundbar remote control or press **(Source)** button on the Soundbar top panel to enter the **"Bluetooth"** mode.

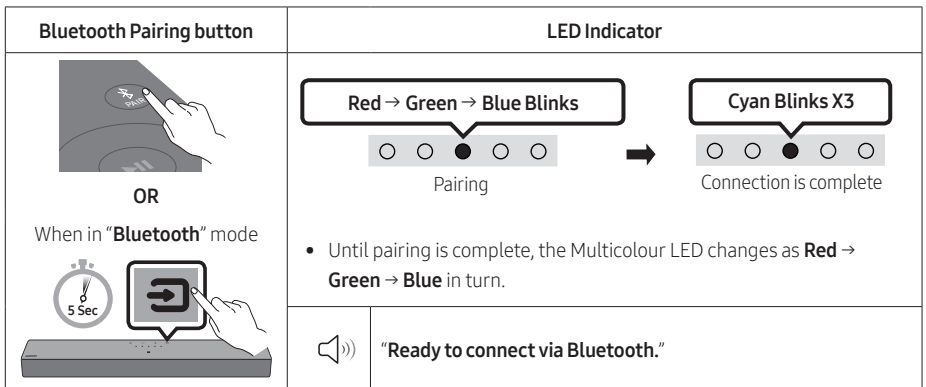

2. Select Bluetooth mode on the Samsung TV.
(e.g. Home (🏠) → Menu → Settings (⚙️) → All Settings (⚙️) → Sound → Sound Output → Bluetooth Speaker List → [AV] B-Series Soundbar (Bluetooth))
3. Select **"[AV] B-Series Soundbar"** from the list on TV's screen.
An available Soundbar is indicated with **"Needs Pairing"** or **"Paired"** on the TV's Bluetooth device list. To connect the Samsung TV to the Soundbar, select the message, and then establish a connection.
4. You can now hear Samsung TV sound from the Soundbar.
 - If there is a connection log between the Soundbar and Samsung TV, the Soundbar is automatically connected by changing its mode to **"Bluetooth"**.

If the device fails to connect

- If you have an existing Soundbar (e.g., “[AV] B-Series Soundbar”) on the list of speakers on the Samsung TV, delete it.
- Then repeat steps 1 through 3.



Disconnecting the Soundbar from the Samsung TV

Press the  (**Source**) button on the top panel or on the remote control to select the mode other than “Bluetooth”.

- Disconnecting takes time because the Samsung TV must receive a response from the Soundbar. (The time required may differ, depending on the Samsung TV model.)

TV Auto connect On/Off

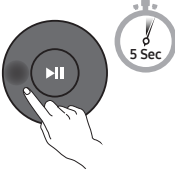
To cancel the automatic Bluetooth connection between the Soundbar and TV, press the **Left** button on the remote control for 5 seconds with the Soundbar in “Bluetooth Ready” status. (Toggle On → Off)

Left button	LED Indicator	
	<p data-bbox="393 708 580 756">Cyan Blinks X1</p>  <p data-bbox="437 799 535 820">On (Default)</p>	<p data-bbox="692 708 879 756">Red Blinks X1</p>  <p data-bbox="770 799 800 820">Off</p>
Bluetooth Ready	Toggle On → Off	

Notes on Bluetooth connection

- Locate a new device within 1 m to connect via Bluetooth communication.
- If asked for a PIN code when connecting a Bluetooth device, enter <0000>.
- The Soundbar automatically turns off after 18 minutes in the Ready state.
- The Soundbar may not perform Bluetooth search or connection correctly under the following circumstances:
 - If there is a strong electrical field around the Soundbar.
 - If several Bluetooth devices are simultaneously paired with the Soundbar.
 - If the Bluetooth device is turned off, not in place, or malfunctions.
- Electronic devices may cause radio interference. Devices that generate electromagnetic waves must be kept away from the Soundbar main unit - e.g., microwaves, wireless LAN devices, etc.

07 CONNECTING AN EXTERNAL DEVICE

Connecting using an Optical Cable

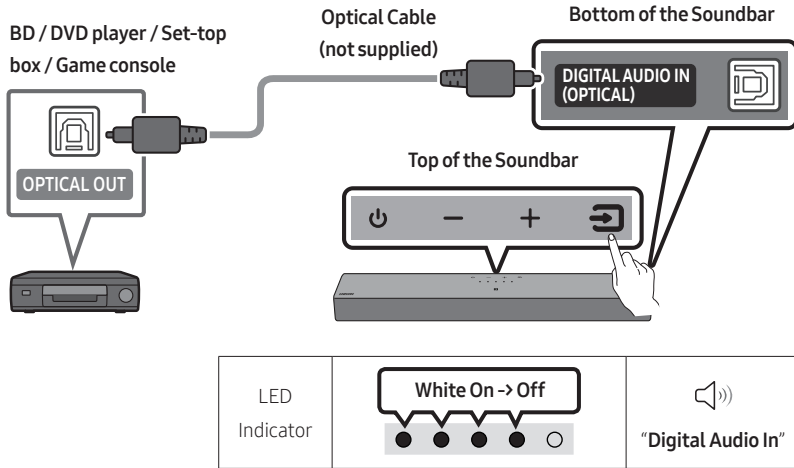

1. With the external device and Soundbar turned off, connect the **DIGITAL AUDIO IN (OPTICAL)** port on the Soundbar and the **OPTICAL** output port on the external device with the optical cable (not supplied), as shown in the figure.
2. Turn on the Soundbar and external device.
3. Press the **Source** button on the top panel or remote control, and then select the **"Digital Audio In"** mode.
4. The external device sound is output from the Soundbar.

08 CONNECTING A USB STORAGE DEVICE

You can play music files located on USB storage devices through the Soundbar.

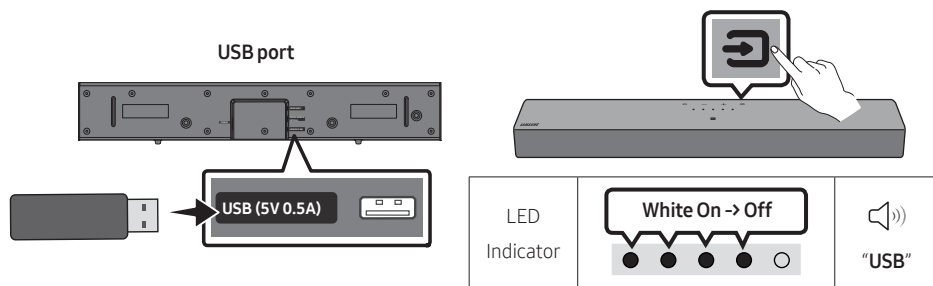

1. Connect the USB device to the USB port on the bottom of the product.
2. Press the  (**Source**) button on the top panel or remote control, and then select the “USB” mode.
3. Play music files from the USB storage device through the Soundbar.
 - The Soundbar automatically turns off (Auto Power Down) if no USB device has been connected for more than 18 minutes.

File Format Type Compatibility list

Extension	Codec	Sampling Rate	Bit Rate
*.mp3	MPEG1 Layer2	32kHz ~ 48kHz	32kbps ~ 320kbps
	MPEG1 Layer3	32kHz ~ 48kHz	32kbps ~ 320kbps
	MPEG2 Layer3	16kHz ~ 24kHz	8kbps ~ 160kbps
	MPEG2.5 Layer3	8kHz ~ 12kHz	8kbps ~ 160kbps
*.aac *.m4a	AAC-LC (MPEG2/MPEG4 Audio Only)	32kHz ~ 48kHz	32kbps ~ 320kbps
*.wav	LPCM	32kHz ~ 192kHz	1,024kbps ~ 9,216kbps
*.flac	FLAC	32kHz ~ 192kHz	162kbps ~ 8,100kbps

- If there are too many folders (about 200) and files (about 2000) stored on the USB device, it may take the Soundbar some time to access and play files.
- Supported USB file system : FAT16, FAT32, NTFS

09 CONNECTING A MOBILE DEVICE

Connecting via Bluetooth



When a mobile device is connected using Bluetooth, you can hear stereo sound without the hassle of cables.

- When you connect a paired Bluetooth device with the Soundbar off, the Soundbar automatically turns on.



mobile device

The initial connection

- When connecting to a new Bluetooth device, make sure the device is within 1 m distance.
1. Press the  **PAIR** button on the Soundbar remote control or press  (**Source**) button on the Soundbar top panel to enter the "Bluetooth" mode.

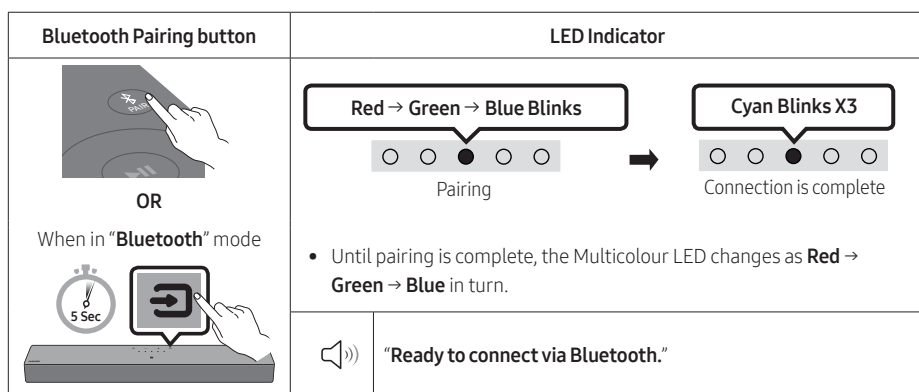

2. On your device, select "[AV] B-Series Soundbar" from the list that appears.
3. Play music files from the device connected via Bluetooth through the Soundbar.

If the device fails to connect

- If you have an existing Soundbar (e.g., "[AV] B-Series Soundbar") on the list of speakers on the Mobile device, delete it.
- Then repeat steps 1 and 2.

Notes on Bluetooth connection

- Locate a new device within 1 m to connect via Bluetooth communication.
- If asked for a PIN code when connecting a Bluetooth device, enter <0000>.
- The Soundbar automatically turns off after 18 minutes in the Ready state.
- The Soundbar may not perform Bluetooth search or connection correctly under the following circumstances:
 - If there is a strong electrical field around the Soundbar.
 - If several Bluetooth devices are simultaneously paired with the Soundbar.
 - If the Bluetooth device is turned off, not in place, or malfunctions.
- Electronic devices may cause radio interference. Devices that generate electromagnetic waves must be kept away from the Soundbar main unit - e.g., microwaves, wireless LAN devices, etc.
- The Soundbar supports SBC data (44.1kHz, 48kHz).
- Connect only to a Bluetooth device that supports the A2DP (AV) function.
- When connecting the Soundbar to a Bluetooth device, place them as close to each other as possible.
- The farther the Soundbar and Bluetooth device are from each other, the lower the sound quality will become.

The Bluetooth connection may break when the devices are out of the effective range.

- The Bluetooth connection may not function as intended in areas with poor reception.
- A Bluetooth device may experience noise or malfunction under in the following conditions:
 - When the body is in contact with the signal transceiver on the Bluetooth device or Soundbar
 - In corners or when there is an obstacle in proximity, such as a wall or partition, where electrical changes may occur.
 - When exposed to radio interferences by other products operating on the same frequency ranges, such as medical equipment, microwave ovens, and wireless LAN devices.
 - Obstacles such as doors and walls may still impact the sound quality even when the devices are within the effective range.
- Note that your Soundbar cannot be paired with other Bluetooth devices while using the Bluetooth option.
- This wireless device may cause electrical interference during operation.

Bluetooth Power On/Off

If a previously paired Bluetooth device tries to pair with the Soundbar when the Bluetooth Power On function is on and the Soundbar is turned off, the Soundbar turns on automatically.

1. Press and hold the **SOUND MODE** button for more than 5 seconds on the remote while the Soundbar is turned on.
2. Multicolour LED indicator on the Soundbar blinks "**Cyan**".

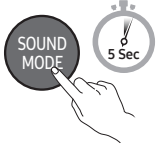
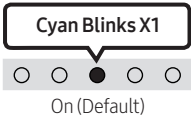
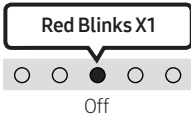
SOUND MODE button	LED Indicator	
	 <p data-bbox="449 475 546 496">On (Default)</p>	 <p data-bbox="804 475 837 496">Off</p>
Bluetooth Power On/Off	Toggle On → Off	

Disconnecting the Bluetooth device from a Soundbar

You can disconnect a Bluetooth device from the Soundbar. For instructions, see the Bluetooth device's user manual.

- The Soundbar will be disconnected.
- If the Soundbar is disconnected from the Bluetooth device, the multicolour LED indicator on the Soundbar blinks "**Red**" three times.

Disconnecting the Soundbar from the Bluetooth device

Press the  (**Source**) button on the top panel or on the remote control to select the mode other than "**Bluetooth**".

- Disconnecting takes time because the Bluetooth device must receive a response from the Soundbar. (Disconnection time may differ, depending on the Bluetooth device)

Connecting a Soundbar to a mobile device via NFC function

Place your mobile device in the NFC detection area on top of the Soundbar.

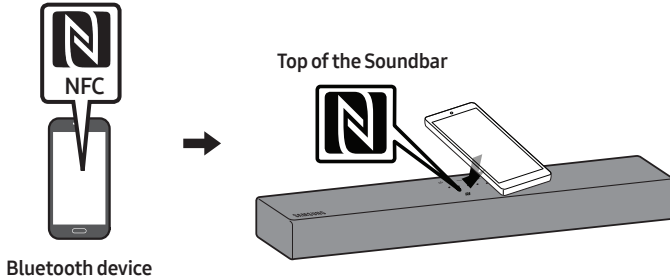

NOTES

- Make sure that your mobile device has the NFC function turned on and that the screen is active.
- Bluetooth connection is unavailable when NFC of the mobile device is in card emulation mode.
- If asked for a PIN code when connecting a Bluetooth device, enter <0000>.
- The Soundbar automatically turns off after 18 minutes in the Ready state.
- The Soundbar may not perform Bluetooth search or connection correctly under the following circumstances:
 - If there is a strong electrical field around the Soundbar.
 - If several Bluetooth devices are simultaneously paired with the Soundbar.
 - If the Bluetooth device is turned off, not in place, or malfunctions.
- Electronic devices may cause radio interference. Devices that generate electromagnetic waves must be kept away from the Soundbar main unit - e.g., microwaves, wireless LAN devices, etc.
- The Soundbar supports SBC data (44.1kHz, 48kHz).
- Connect only to a Bluetooth device that supports the A2DP (AV) function.
- Once you have paired the Soundbar to a Bluetooth device, selecting “[AV] B-Series Soundbar” from the device’s scanned devices list will automatically change the Soundbar to “Bluetooth” mode.
 - Available only if the Soundbar is listed among the Bluetooth device’s paired devices.
(The Bluetooth device and the Soundbar must have been previously paired at least once.)
- The Soundbar cannot be paired to another Bluetooth device if already in Bluetooth mode and paired to a Bluetooth device.

10 INSTALLING THE WALL MOUNT (OPTIONAL)

Installation Precautions

- Install on a vertical wall only.
- Do not install in a place with high temperature or humidity.
- Verify whether the wall is strong enough to support the product's weight. If not, reinforce the wall or choose another installation point.
- Purchase and use the fixing screws or anchors appropriate for the kind of wall you have (plaster board, iron board, wood, etc.). If possible, fix the support screws into wall studs.
- Purchase wall mounting screws according to the type and thickness of the wall you want to mount the Soundbar on.
 - Diameter: M4
 - Length: 40 mm or longer recommended.
- Connect cables from the unit to external devices before you install the Soundbar on the wall.
- Make sure the unit is turned off and unplugged from the power source before you install it. Otherwise, it may cause an electric shock.

Wall mount Components

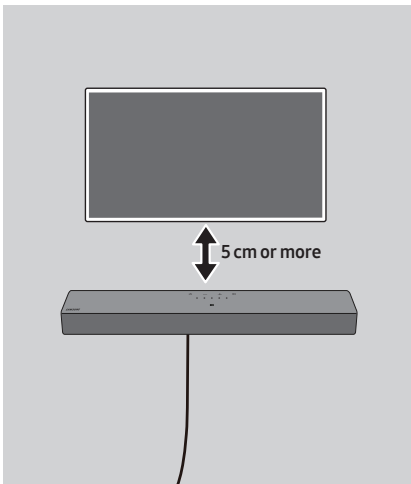

For Installation on Concrete Walls (not supplied)

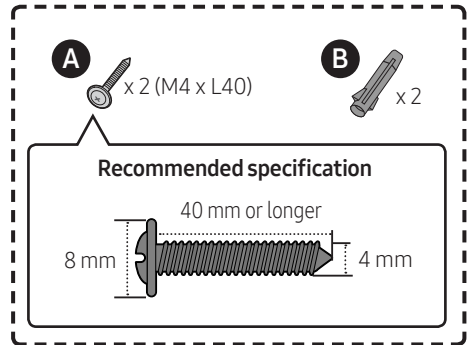

NOTE

- Installations on other types of walls will require different kinds of screws.

1.

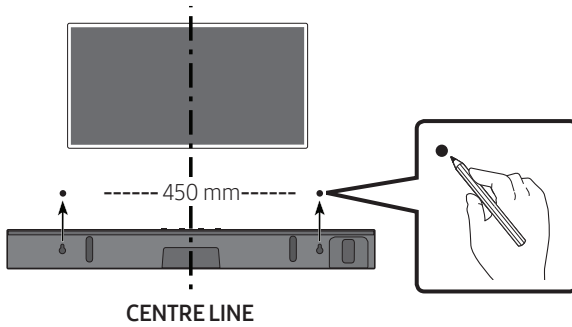

NOTES

- If your TV is installed on the wall, install the Soundbar 5cm or more below your TV.
- Use a pencil to mark the holes' positions.

2.

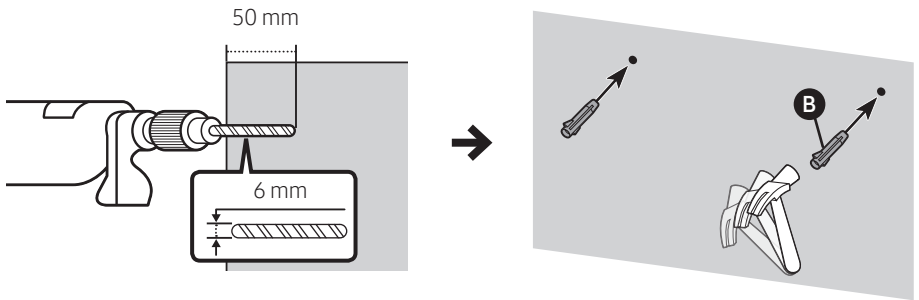

IMPORTANT NOTE

- The installation method shown here is for CONCRETE walls. Installation methods will vary depending on the wall type. For installation on dry wall, we strongly recommend you drill screw support holes into the underlying wood studs.

3.

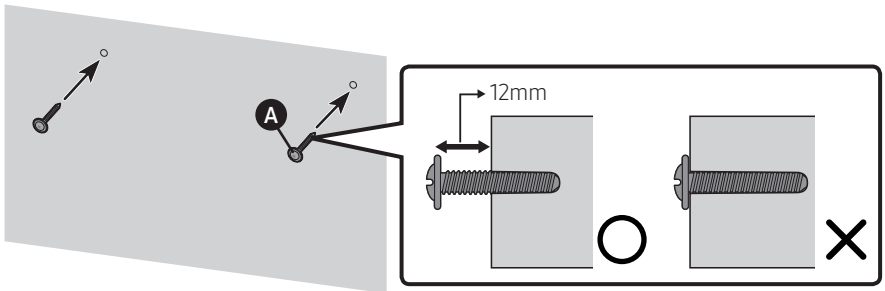

4.

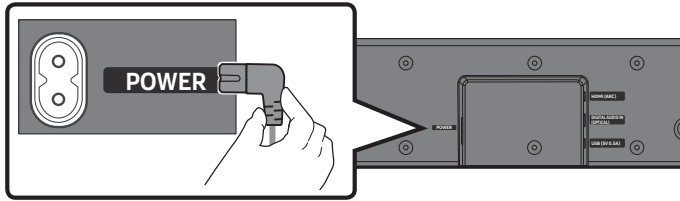

5.

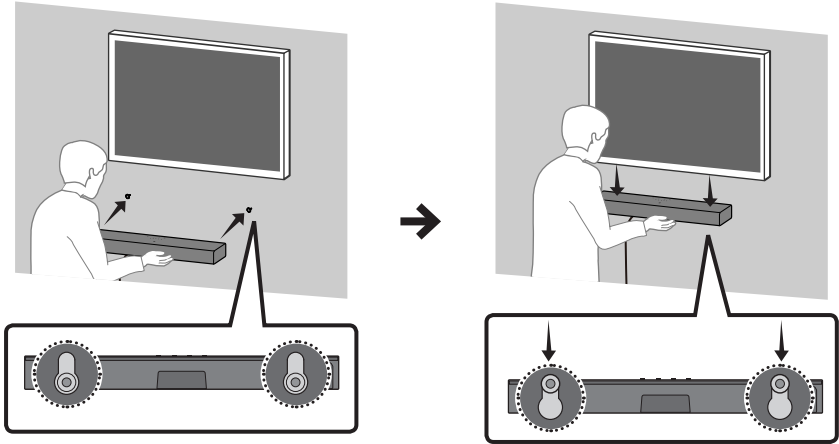

NOTE

- Supports for wall installation are built into the back of the Soundbar.

⚠ CAUTION

- Press the Soundbar down with sufficient force to fix it to the wall. If the Soundbar is not firmly fixed to the wall, it could be accidentally detached, resulting in personal injury.
- Do not bump into or strike the Soundbar (especially from the bottom). The impact could detach the Soundbar from the wall, resulting in personal injury.

11 SOFTWARE UPDATE

Important: After upgrading, keep the original Settings.

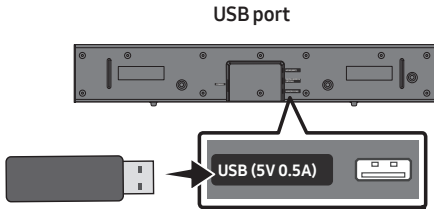

1. Connect a USB memory stick to the USB port on your computer.
Important: Make sure there are no music files on the USB memory stick drive. This may cause the firmware update to fail.
2. Go to (www.samsung.com) → select Enter Model Number and enter the model of your Soundbar. Select manuals and downloads and download the latest software file.
3. Save the downloaded software to a USB memory stick and select "Extract Here" to unzip the folder.
4. Turn off the Soundbar and connect the USB stick containing the software update to the **USB** port.

5. Plug USB into Soundbar and switch to USB source, the software will update automatically and will complete update within 2 minutes. During the update process, the 5 LEDs will start flashing in a loop, and then the 5 LEDs will all be bright white, and then the 5 LEDs will flash in a loop again. When the update is complete, the cyan indicator blinks 3 times, and the soundbar automatically restarts.

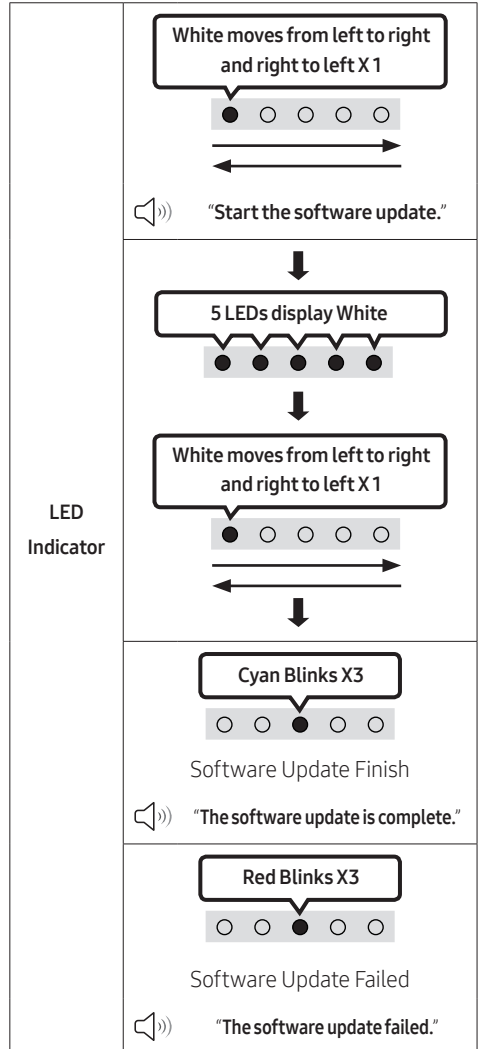

- This product has a DUAL BOOT function. If the firmware fails to update, you can update the firmware again.

If LED sequence flashing is not displayed

1. Turn off the Soundbar, disconnect and then reconnect the USB storage device that contains the update files to the Soundbar's **USB** port.
2. Disconnect the Soundbar's power cord, reconnect it, and then turn on the Soundbar.

NOTES

- The firmware update may not work properly if audio files supported by the Soundbar are stored in the USB storage device.
- Do not disconnect the power or remove the USB device while updates are being applied. The main unit will turn off automatically after completing the firmware update.
- After upgrading, keep the original Settings. (include Volume, sound field, etc.)
 - When the firmware update is complete, the soundbar automatically turns on, and the Voice UI comes out. If the software update fails, check if the USB stick is defective.
- Mac OS users should use MS-DOS (FAT) as the USB format.
- Updating via USB may not be available, depending on the USB storage device manufacturer.

Reset

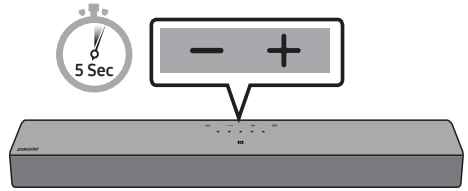

With the Soundbar on, press the **– + (Volume)** buttons on the body at the same time for at least 5 seconds. The LED display changes as shown below and then the Soundbar is reset.

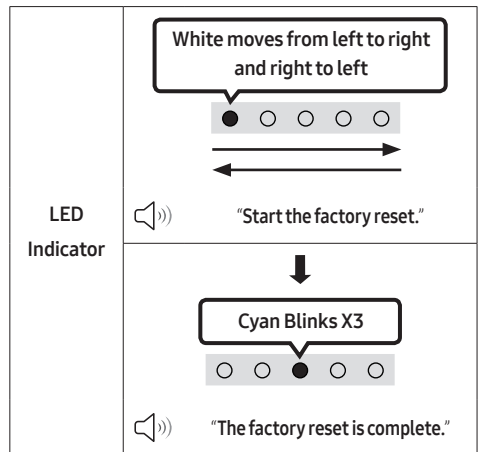

CAUTION

- All the settings of the Soundbar are reset. Be sure to perform this only when a reset is required.

12 TROUBLESHOOTING

Before seeking assistance, check the following.

Soundbar does not turn on.

- Check whether the power cord of the Soundbar is correctly inserted into the outlet.

Soundbar works erratically.

- After removing the power cord, insert it again.
- Power cycle the external device and try again.
- If there is no signal, the Soundbar automatically turns off after a certain period of time. Turn on the power. (See page 9.)

Remote control does not work.

- Point the remote directly at the Soundbar.
- Replace the batteries with new ones.

Soundbar does not output any sound.

- The volume of the Soundbar is too low or muted. Adjust the volume.
- When any external device (STB, Bluetooth device, mobile device, etc.) is connected, adjust the volume of the external device.
- For sound output of the TV, select Soundbar. (Samsung TV: Home (🏠) → Menu → Settings (⚙️) → All Settings (⚙️) → Sound → Sound Output → Select Soundbar)
- The cable connection to the Soundbar may be loose. Remove the cable and connect again.
- Remove the power cord completely, reconnect, and turn the power on.
- Reset the product and try again. (See page 32.)

If the TV is not connected via HDMI (ARC).

- Check whether the HDMI cable is correctly connected to the ARC terminal. (See page 17)
- Connection may not be possible due to the connected external device (set-top box, game machine, etc.). Directly connect the Soundbar.
- HDMI-CEC may not be activated on the TV. Turn on the CEC on the TV menu. (Samsung TV: Home (🏠) → Menu → Settings (⚙️) → All Settings (⚙️) → Connection → External Device Manager → Anynet+ (HDMI-CEC) ON)

Soundbar does not connect via Bluetooth.

- When connecting a new device, switch to Bluetooth Pairing for connection. (Press the **PAIR** button on the remote control or press the **Source** button on the body for at least 5 seconds.)
- If the Soundbar is connected to another device, disconnect that device first to switch the device.
- Reconnect it after removing the Bluetooth speaker list on the device to connect. (Samsung TV: Home (🏠) → Menu → Settings (⚙️) → All Settings (⚙️) → Sound → Sound Output → Bluetooth Speaker List)
- Remove and reconnect the power plug, then try again.
- Reset the product and try again. (See page 32.)

Sound drops out when connected via Bluetooth.

- If your device that is connected via Bluetooth moves too far away from the Soundbar, it may cause the sound to drop out. Move the device closer to the Soundbar.
- If a part of your body is in contact with the Bluetooth transceiver or the product is installed on metal furniture, sound may drop out. Check the installation environment and conditions for use.

Soundbar does not turn on automatically with the TV.

- If you turn off the Soundbar while watching TV, the power synchronization with the TV will be disabled. Power off the TV and Soundbar using the TV remote.

13 LICENCES & OTHER INFORMATION



Dolby, Dolby Audio, and the double-D symbol are trademarks of Dolby Laboratories Licensing Corporation. Manufactured under license from Dolby Laboratories. Confidential unpublished works. Copyright © 1992–2019 Dolby Laboratories. All rights reserved.



FOR DTS PATENTS, SEE [HTTP://XPERI.COM/DTS-PATENTS/](http://xperi.com/dts-patents/). MANUFACTURED UNDER LICENSE FROM DTS, INC. AND ITS AFFILIATES. DTS, THE DTS LOGO, AND DIGITAL SURROUND ARE REGISTERED TRADEMARKS OR TRADEMARKS OF DTS, INC. AND ITS AFFILIATES IN THE UNITED STATES AND/OR OTHER COUNTRIES. © DTS, INC. AND ITS AFFILIATES. ALL RIGHTS RESERVED.



The terms HDMI, HDMI High-Definition Multimedia Interface, HDMI Trade dress and the HDMI Logos are trademarks or registered trademarks of HDMI Licensing Administrator, Inc.



The Bluetooth® word mark and logos are registered trademarks owned by Bluetooth SIG, Inc. and any use of such marks by Samsung Electronics Co., Ltd. is under license. Other trademarks and trade names are those of their respective owners.

Please visit www.samsung.com/global/ecodesign_energy to find further information about off mode, standby mode, and networked standby mode associated with EU standby ecodesign regulation.

Open Source License Notice

Open Source used in this product can be found on the following webpage (<http://opensource.samsung.com>).

14 IMPORTANT NOTES ABOUT SERVICE

- Figures and illustrations in this User Manual are provided for reference only and may differ from actual product appearance.
- An administration fee may be charged if either
 - (a) an engineer is called out at your request and there is no defect with the product (i.e. where the user manual has not been read).
 - (b) you bring the unit to a repair centre and there is no defect with the product (i.e. where the user manual has not been read).
- You will be informed of the administration fee amount before a technician visits.

15 SPECIFICATIONS AND GUIDE

Specifications

Model Name	HW-B400F
USB	5V/0.5A
Weight	2.1 kg
Dimensions (W x H x D)	641.0 x 66.5 x 107.0 mm
Operating Temperature Range	+10 °C to +40 °C
Operating Humidity Range	10 % to 80 %, non-condensing
Storage Temperature Range	-20 °C to +45 °C
Storage Humidity Range	5 % to 95 %, non-condensing
AMPLIFIER Max Output Power	20W x 2
Supported play formats	LPCM 2ch, Dolby Audio™ (supporting Dolby® Digital), DTS
Overall Standby Power Consumption (W)	2.0W
Bluetooth Port deactivation method	Press and hold the SOUND MODE button for more than 5 seconds to turn off Bluetooth Power function.

NOTES

- Samsung Electronics Co., Ltd reserves the right to change the specifications without notice.
- Weight and dimensions are approximate.

- Hereby, Samsung declares that this radio equipment is in compliance with Directive 2014/53/EU and the relevant UK statutory requirements. The full text of the declaration of conformity is available at the following internet address: <http://www.samsung.com> go to Support and enter the model name. This equipment may be operated in all EU countries and in the UK.

- **WIRELESS DEVICE OUTPUT POWER**

- RF max transmitter power**

- 100mW at 2.4GHz – 2.4835GHz



[Correct disposal of batteries in this product]

(Applicable in countries with separate collection systems)

This marking on the battery, manual or packaging indicates that the batteries in this product should not be disposed of with other household waste at the end of their working life. Where marked, the chemical symbols Hg, Cd or Pb indicate that the battery contains mercury, cadmium or lead above the reference levels in EC Directive 2006/66.

If batteries are not properly disposed of, these substances can cause harm to human health or the environment.

To protect natural resources and to promote material reuse, please separate batteries from other types of waste and recycle them through your local, free battery return system.



**Correct Disposal of This Product
(Waste Electrical & Electronic Equipment)**

(Applicable in countries with separate collection systems)

This marking on the product, accessories or literature indicates that the product and its electronic accessories (e.g. charger, headset, USB cable) should not be disposed of with other household waste at the end of their working life. To prevent possible harm to the environment or human health from uncontrolled waste disposal, please separate these items from other types of waste and recycle them responsibly to promote the sustainable reuse of material resources.

Household users should contact either the retailer where they purchased this product, or their local government office, for details of where and how they can take these items for environmentally safe recycling.

Business users should contact their supplier and check the terms and conditions of the purchase contract. This product and its electronic accessories should not be mixed with other commercial wastes for disposal.

For information on Samsung's environmental commitments and product specific regulatory obligations e.g. REACH, WEEE, Batteries, visit:

www.samsung.com/uk/aboutsamsung/sustainability/environment/our-commitment/data/



UNITED KINGDOM



EIRE

This Samsung product is warranted for the period of twelve (12) months from the original date of purchase, against defective materials and workmanship. In the event that warranty service is required, you should return the product to the retailer from whom it was purchased. However, Samsung Authorised Dealers and Authorised Service in the countries listed in Warranty Conditions will comply with the warranty on the terms issued to purchasers in the country concerned. Details of our Authorised Service Centres are available from:

Samsung Electronics U.K. Ltd.

Samsung Customer Support Centre

Selectapost 38, Sheffield, S97 3FJ, United Kingdom

United Kingdom: Tel. 0333 000 0333

www.samsung.com/uk/support

EIRE: Tel. 0818 717100

www.samsung.com/ie/support

■ WARRANTY CONDITIONS

1. The warranty is only valid if, when warranty service is required, the warranty card is fully and properly completed and is presented with the original invoice or sales slip or confirmation, and the serial number on the product has not been defaced.
2. Samsung's obligations are limited to the repair or, at its discretion, replacement of the product or the defective part. Repaired or replaced products may include new and/or refurbished components and equipment.
3. Warranty repairs must be carried out by Authorised Samsung Dealers or Authorised Service Centres. No re-imburement will be made for repairs carried out by non-Samsung Dealers and, any such repair work and damage to the products caused by such repair work will not be covered by this warranty.
4. This product is not considered to be defective in materials nor workmanship by reason that it requires adaptation in order to conform to national or local technical or safety standards in force in any Country other than the one for which the product was originally designed and manufactured. This warranty will not cover, and no re-imburement will be made for such adaptation nor any damage which may result.
5. This warranty covers none of the following:
 - a) Periodic check-ups, maintenance and repair or replacement of parts due to normal wear and tear.
 - b) Cost relating to transport, removal or installation of the product.
 - c) Misuse, including the failure to use this product for its normal purposes or incorrect installation.
 - d) Use of this product in a commercial/ business environment, which shall include, but is not limited to, the following: any use for profit or financial gain, public display or events such as clubs, bars and restaurants including continuous statistical or graphical display, or any commercial use of continuous or intentional long term display of News reels ("tickers"), static or fixed images such as timetables and 4:3 pictures or video content displaying permanent black bars.
 - e) Damage caused by Lightning, Water, Fire, Acts of God, War, Public Disturbances, incorrect mains voltage, improper ventilation or any other cause beyond the control of Samsung.
 - f) Spillage of food or liquid or use of any other hazardous substances, which may affect the product.
 - g) Performance due to differences in broadcasting method between countries.
6. This warranty is valid for any person who legally acquired possession of the product during the warranty period.
7. The consumer's statutory rights in any applicable national legislation whether against the retailer arising from the purchase contract or otherwise are not affected by this warranty Unless there is national legislation to the contrary, the rights under this warranty are the consumer's sole rights and Samsung, its subsidiaries and distributors shall not be liable for indirect or consequential loss or any damage to connected storage media or any other related equipment or material.
8. Some products may differ from these guidelines. Please check with your dealer or the local Samsung web-site.
9. Samsung shall honour warranties for all EU specification products purchased by a consumer within the following European countries listed.
 - UK, Republic of Ireland, Germany, France, Italy, Malta, Spain, Portugal, The Netherlands, Belgium, Luxembourg, Denmark, Sweden, Finland, Poland, Hungary, Czech Republic, Slovakia, Austria, Slovenia, Croatia, Estonia, Latvia, Lithuania, Greece, Cyprus, Romania, Bulgaria, Switzerland, Norway, Lichtenstein and Iceland.

SAMSUNG ELECTRONICS (U.K.) LTD.

© 2025 Samsung Electronics Co., Ltd. All rights reserved.

Contact Samsung world wide

If you have any questions or comments relating to Samsung products, please contact the Samsung customer care Centre.

Country/ Region	Samsung Service Centre ☎	Web Site	Country/ Region	Samsung Service Centre ☎	Web Site
UK	0333 000 0333	www.samsung.com/uk/support	NORTH MACEDONIA	023 207 777	www.samsung.com/mk/support
IRELAND (EIRE)	0818 717100	www.samsung.com/ie/support	MONTENEGRO	020 405 888	www.samsung.com/support
GERMANY	06196 77 555 77	www.samsung.com/de/support	SLOVENIA	080 697 267 (brezplačna številka)	www.samsung.com/si/support
FRANCE	01 48 63 00 00	www.samsung.com/fr/support	SERBIA	011 321 6899	www.samsung.com/rs/support
SPAIN	91 175 00 15	www.samsung.com/es/support	KOSOVO	038 40 30 90	www.samsung.com/support
PORTUGAL	210 608 098 Chamada para a rede fixa nacional Dias úteis das 9h às 20h	www.samsung.com/pt/support	ALBANIA	045 620 202	www.samsung.com/al/support
LUXEMBURG	261 03 710	www.samsung.com/be_fr/support	BULGARIA	0800 111 31 - Безплатен за всички оператори *3000 - Цена на един градски разговор или според тарифата на мобиленият оператор 09:00 до 18:00 - Понеделник до Петък	www.samsung.com/bg/support
NETHERLANDS	088 90 90 100	www.samsung.com/nl/support	ROMANIA	0800872678 - Apel gratuit *8000 - Apel tarifat în rețea Program Call Center Luni - Vineri: 9 AM - 6 PM	www.samsung.com/ro/support
BELGIUM	02-201-24-18	www.samsung.com/be/support (Dutch) www.samsung.com/be_fr/support (French)	ITALIA	800-SAMSUNG (800.7267864)	www.samsung.com/it/support
NORWAY	2162 90 99	www.samsung.com/no/support	CYPRUS	8009 4000 only from landline, toll free	www.samsung.com/gr/support
DENMARK	70 70 19 70	www.samsung.com/dk/support	GREECE	80111-SAMSUNG (80111 726 7864) from mobile and land line (+30) 210 6897691 from mobile and land line	www.samsung.com/pl/support/
FINLAND	030-622 75 15	www.samsung.com/fi/support	POLAND	801-172-678* * (opłata według taryfy operatora)	www.samsung.com/lt/support
SWEDEN	0771-400 300	www.samsung.com/se/support	LITHUANIA	8-800-77777	www.samsung.com/lv/support
AUSTRIA	0800 72 67 864 (0800-SAMSUNG)	www.samsung.com/at/support	LATVIA	8000-7267	www.samsung.com/ee/support
SWITZERLAND	0800 726 786	www.samsung.com/ch/support (German) www.samsung.com/ch_fr/support (French)	ESTONIA	800-7267	
HUNGARY	0680SAMSUNG (0680-726-7864)	www.samsung.com/hu/support			
CZECH	800 - SAMSUNG (800-726786)	www.samsung.com/cz/support			
SLOVAKIA	0800 - SAMSUNG (0800-726 786)	www.samsung.com/sk/support			
CROATIA	072 726 786	www.samsung.com/hr/support			
BOSNIA	055 233 999	www.samsung.com/ba/support			