

Panasonic®

Operating Instructions

Steam Combination Microwave Oven



Model No. NN-DS59NB
Household Use Only

INVERTER



Scan the QR code for more recipes:
experience-fresh.panasonic.eu/NN-DS59

Important safety instructions. Please read carefully and keep for future reference.



**Steamed Provencal
Fish Fillets**



**Steamed Chicken
with Lemon and
Thyme**

Important Notice

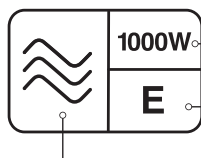

Microwave symbol

The IEC (60705) power output (watts)

The heating category for small packs of food

Thank you for purchasing a Panasonic Microwave Oven.

Your oven is rated 1000 Watts (IEC). When using other cookbooks remember to adjust cooking times accordingly. The symbol indicates the heating category for your oven when cooking or reheating convenience foods.

Your oven is rated 'E', which is very efficient. It is therefore very important that you refer carefully to the packet instructions on convenience foods.

Some packet instructions only display information for B or D rated ovens. We therefore provide additional guidelines for reheating and cooking on pages **97-112** of this book.

Always check the progress of the food as it cooks or reheats by simply opening the door. After checking the progress of the foods, Press the **Dial** to continue the cooking time.

Failure to follow the instructions given in this operating instruction, may affect the recipe result and in some instances may be dangerous.

 Customer Communications Centre 0344 844 3899

Selected Spares and Accessories:

Order direct on line at www.panasonic.co.uk or by telephoning the Customer Communications Centre number above.

For Cookery Advice call: 01344 862108

(open Monday to Wednesday 9 am - 12 pm)

Alternatively visit our web site at experience-fresh.eu

Or write to the address below:

Home Appliance Innovation Centre

Panasonic UK, a branch of Panasonic Marketing Europe GmbH,

Maxis 2

Western Road

Bracknell

Berkshire

RG12 1RT

UK

CONTENTS

Thank you for purchasing this Panasonic appliance.

Safety Instructions	6-11
Disposal of Old Equipment.....	12
Important Safety Instructions.....	12-13
Before Using Your Oven	14
Placement of Your Oven	15
Care & Cleaning of Your Oven	15-17
Maintenance of Your Oven	17-18
Accessory Advice.....	18
Oven Accessory	19
Parts of Your Oven	20-21
Important Information	22-25
Microwaving Principles.....	25-26
Control Panel	27
How to Use the Dial	28
Display Window	28
General Guidelines.....	29-31
Quick Check Guide to Cooking Utensils.....	32
Containers to Use.....	33-34
Cooking Modes.....	35-37
Let's Start to Use Your Oven	38
Setting the Clock	39
Beep Choice.....	40
Child Lock	41
Operation Guide Setting	41
Microwave Cooking and Defrosting	42-43
Defrosting Guidelines	44

Defrosting Charts	45-46
Grilling	47-48
Oven Cooking	49-51
Steam Cooking	52-54
Steam Shot.....	55
Combination: Grill and Microwave	56-57
Combination: Cooking with Steam	58-60
Multi-stage Cooking	61-63
Using the Timer	64-67
Using the Add Time Function.....	68
Sensor Reheat Programs.....	69-71
Auto Steam Programs.....	72-74
Healthy Grill & Fries Programs	75-77
Auto Cook Programs.....	78-80
Re-bake Bread Programs.....	81-82
Junior Menu	83-86
Chaos Defrost.....	87-89
Cleaning Setting	90-93
Drain Water.....	90
System Cleaning.....	91-92
Deodorization.....	92
Cavity Cleaning.....	93
Cleaning the Water Tank	94
Cooking and Reheating Guidelines	95-96
Reheating Charts.....	97-102
Cooking Charts.....	103-111
Low-Oil Oven Fry Charts	111-112
Questions and Answers.....	113-114
Recipes.....	115-118
Specifications	119

Safety Instructions

- Important safety instructions. Before operating this oven, please read these instructions carefully and keep for future reference.
- This appliance can be used by children aged from 8 years and above and persons with reduced physical, sensory and mental capabilities or lack of experience and knowledge if they have been given supervision or instruction by a person responsible for their safety concerning the use of the appliance in a safe way and understand the hazards involved, including escaping steam. Children shall not play with the appliance. Cleaning and user maintenance shall not be made by children without supervision. Keep the appliance and its cord out of reach of children less than 8 years.
- When this oven is installed, it should be easy to isolate the appliance from the electricity supply by pulling out the plug or operating a circuit breaker.
- If the supply cord is damaged, it must be replaced by the manufacturer or its service agent or a similarly qualified person in order to avoid a hazard.
- **Warning!** It is hazardous for anyone other than a competent person to carry out any service or repair operation which involves the removal of a cover which gives protection against exposure to microwave energy. The appliance should be inspected for damage to the door seals and door seal areas and If the door or door seals are damaged, the oven must not be operated until it has been repaired by a competent person.

Safety Instructions

- **Warning!** Do not attempt to tamper with or make any adjustments or repairs to the door, control panel housing, safety interlock switches or any other part of the oven.
- **Warning!** Do not remove the outer panel from the oven which gives protection against exposure to microwave energy.
- Repairs should only be made by a qualified service person.
- **Warning!** Liquids and other foods must not be heated in sealed containers since they are liable to explode.
- **Warning!** Only allow children to use the oven without supervision when adequate instructions have been given so that the child is able to use the oven in a safe way and understands the hazards of improper use. Ensure that children do not touch the hot outer casing after operation of the oven.
- This oven is intended for counter-top use only. It is not intended for built-in use or for use inside a cupboard. The appliance shall not be placed in a cabinet.

For counter-top use:

- The oven must be placed on a flat, stable surface 85 cm above the floor, with rear of oven placed against a back wall. For proper operation the oven must have sufficient air flow, i.e. 5 cm at one side, the other being open; 25 cm clear over the top; 10 cm at the rear.
- When heating food in plastic or paper containers, check the oven frequently as these types of containers ignite if overheated.

Safety Instructions

- If smoke is emitted or a fire occurs in the oven, tap **Stop/Cancel** pad and leave the door closed in order to stifle any flames. Disconnect the power cord, or shut off power at fuse or circuit breaker panel.
- This appliance is intended to be used in household applications only.
- When heating liquids, e.g. soup, sauces and beverages in your oven, overheating the liquid beyond boiling point can occur without evidence of bubbling. This could result in a sudden boil over of the hot liquid.
- Microwave heating of beverages can result in delayed eruptive boiling, therefore care must be taken when handling the container.
- The contents of feeding bottles and baby food jars are to be stirred or shaken. The temperature has to be checked before consumption to avoid burns.
- Do not cook eggs in their shells and whole hard-boiled eggs by **microwave**. Pressure may build up and the eggs may explode, even after the microwave heating has ended.
- Clean the inside of the oven, door seals and door seal areas regularly. When food splatters or spilled liquids adhere to the oven walls, base of the oven, door seals and door seal areas wipe off with a damp cloth. Mild detergent may be used if they get very dirty. The use of harsh detergent or abrasive is not recommended.
- **Do not use commercial oven cleaners.**

Safety Instructions

- Some foods may inevitably splatter grease on to the oven walls. If the oven is not cleaned occasionally, it may start to 'smoke' during use.
- Failure to maintain the oven in a clean condition could lead to deterioration of surfaces that could affect the life of the appliance and possibly result in a hazardous situation.
- **Warning!** The accessible parts may become hot in **Grill, Oven, Steam** and **Combination** use. Young children less than 8 years of age should be kept away. Children should only use the oven under adult supervision due to the temperatures generated.
- A steam cleaner is not to be used for cleaning the appliance.
- Do not use harsh, abrasive cleaners or sharp metal scrapers to clean the oven door glass since they can scratch the surface, which may result in shattering of the glass.
- Exterior oven surfaces, including air vents on the cabinet and the oven door will get hot during **Grill, Oven, Steam,** and **Combination** modes, take care when opening or closing the door and when inserting or removing food and accessory.
- This appliance is not intended to be operated by means of an external timer or separate remote-control system.
- In case of electronic failure, oven can only be turned off at the wall socket.
- Only use utensils that are suitable for use in microwave ovens.

Safety Instructions

- **Warning!** This appliance produces boiling hot steam.
- During and after cooking with steam function, do not open the oven door when your face is very close to the oven. Care must be taken when opening the door as steam may cause injury.
- **Warning!** Steam may billow out when you open the door. If there is steam in the oven, do not reach in with your bare hands! Risk of burns! Use oven gloves.
- Please refer to pages 18-19 for correct installation of the shelf accessory.
- The oven has heating elements situated in the top and in the base of the oven. After using the **Grill, Oven, Steam** and **Combination** functions, the inside surfaces of the oven will be very hot. Care should be taken to avoid touching the heating element inside the oven. To prevent burns, care should be taken to avoid touching the inside surfaces of the oven. N.B. After cooking by these functions, the oven accessory will be very hot.
- Metal containers or dishes with metallic trim should not be used during microwave cooking. Sparking will occur.
- This microwave oven is intended for heating food and beverages only. Take care when heating foods low in moisture, e.g. bread items, chocolate, biscuits and pastries. These can easily burn, dry out or catch fire if cooked too long. We do not recommend heating foods low in moisture such as popcorn or poppadoms. Drying of food, newspapers or clothing and heating of warming pads, slippers, sponges, damp cloths, wheat bags, hot water bottles and similar may lead to risk of injury, ignition or fire.

Safety Instructions

- The oven lamp must be replaced by a service technician trained by the manufacturer. **Do not** attempt to remove the outer casing from the oven.
- Before using the oven, place the drip tray in position. Refer to page 20 for correct installation.
- The purpose of the drip tray is to collect excess water during **Steam** and **Steam Combination** mode. It should be emptied after each **Steam** and **Steam Combination** operation.
- Do not use the water tank if it is cracked or broken, as leaking water could result in electrical failure and danger of electric shock. If the water tank becomes damaged, please contact your dealer.
- **Caution!** In order to avoid a hazard due to inadvertent resetting of the thermal cut-out, this appliance must not be supplied through an external switching device, such as a timer, or connected to a circuit that is regularly switched on and off by the utility.
- The appliance must not be installed behind a decorative door in order to avoid overheating.
- The oven should be cleaned regularly and any food deposits removed.

Disposal of Old Equipment



Only for European Union and Countries with Recycling Systems

This symbol on the products, packaging, and/or accompanying documents means that used electrical and electronic products must not be mixed with general household waste.

For proper treatment, recovery and recycling of old products, please take them to applicable collection points in accordance with your national legislation.

By disposing of them correctly, you will help to save valuable resources and prevent any potential negative effects on human health and the environment.



For more information about collection and recycling, please contact your local municipality.

Penalties may be applicable for incorrect disposal of this waste, in accordance with national legislation.

Important Safety Instructions

Please read carefully and keep for future reference.

This appliance is supplied with a moulded three pin mains plug for your safety and convenience. A 13 amp fuse is fitted in this plug. Should the fuse need to be replaced, please ensure that the replacement fuse has a rating of 13 amps and that it is approved by ASTA or BSI to BS1362.

Check for the ASTA mark  or the BSI mark  on the body of the fuse.

If the fuse cover is detachable, never use the plug with the cover omitted.

A replacement fuse cover can be purchased from your local Panasonic dealer.

■ How to replace the fuse

Open the fuse compartment with a screwdriver and replace the fuse.

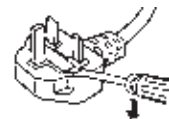

Important Safety Instructions

If the fitted moulded plug is unsuitable for the socket outlet in your home then the fuse should be removed and the plug cut off and disposed of safely and an appropriate one fitted. There is a danger of severe electrical shock if the cut off plug is inserted into any 13 amp socket.

If a new plug is to be fitted, please observe the wiring code as shown opposite. If in any doubt, please consult a qualified electrician (For U.K. Models only).



Warning!

This appliance must be earthed.



Important

The wires in this mains lead are coloured in accordance with the following code:

Green-and-yellow: Earth

Blue: Neutral

Brown: Live

As the colours of the wire in the mains lead of this appliance may not correspond with the coloured markings identifying the terminals in your plug, proceed as follows:

The wire which is coloured **green-and-yellow** must be connected to the terminal in the plug which is marked with the letter **E** or by the

Earth symbol \perp or coloured **green** or **green-and-yellow**.

The wire which is coloured **blue** must be connected to the terminal in the plug which is marked with the letter **N** or coloured **black**. The wire which is coloured **brown** must be connected to the terminal in the plug which is marked with the letter **L** or coloured **red**.

When this oven is installed it should be easy to isolate the appliance from the electricity supply by pulling out the plug or operating a circuit breaker.



Voltage & Power

The voltage used must be the same as specified on this microwave oven. Using a higher voltage than that which is specified is dangerous and may result in a fire or other type of accident causing damage.

Do not immerse cord, plug or oven in water. Keep cord away from heated surfaces. Do not let cord hang over the edge of table or work top. Do not plug your oven in via an extension cable as this can be dangerous. It is important to plug the oven directly into a wall socket.

The back of the appliance heats up during use. Do not allow the cord to be in contact with the back of the appliance or cabinet surface.

Before Using Your Oven

Examine your Oven

1. Unpack oven, remove all packing material, and examine the oven for any damage such as dents, broken door latches, cracks in the door or any damage to the water tank. Notify dealer immediately if unit is damaged. **DO NOT** install if unit is damaged.

Guarantee

2. Your receipt is your guarantee, please keep it safe.

Cord

3. If the supply cord of this appliance is damaged, it must be replaced by the manufacturer or it's service agent or a similarly qualified person in order to avoid a hazard.

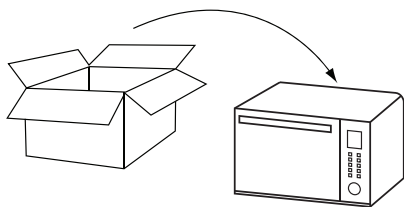

4. Before using **grill, oven, steam** or **combination** function for the first time operate the oven without food and the accessory on **oven 220 °C for 10 minutes**. This will allow the oil that is used for rust protection to be burned off. This is the only time that the oven is operated completely empty (except when preheating).



Caution! Hot Surfaces!

Exterior oven surfaces including air vents on the cabinet and the oven door will get hot during **Combination/Grill/Oven/Steam**. After cooking by these modes, the oven accessory will be very hot.

Do not operate the oven empty

apart from point 4 above and when preheating. The appliance must not be operated by **Microwave** or combination including microwave **without food in the oven**.

Operation when empty will damage the appliance. During use the appliance becomes hot. Care should be taken to avoid touching heating elements inside the oven. The accessible parts may become hot in **Grill, Oven, Steam, and Combination** use. Young children less than 8 years of age should be kept away. Children should only use the oven under adult supervision due to the temperatures generated.

Placement of Your Oven

This oven is intended for counter-top use only. It is not intended for built-in use or for use inside a cupboard. The appliance shall not be placed in a cabinet.

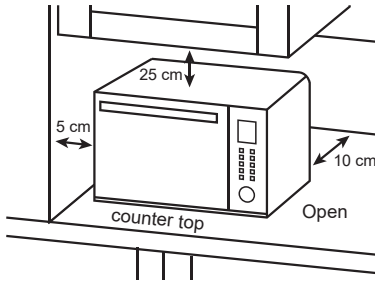

1. The oven must be placed on a flat, stable surface 85 cm above the floor, with rear of oven placed against a back wall. For proper operation the oven must have sufficient air flow, i.e. 5 cm at one side, the other

being open; 25 cm clear over the top; 10 cm at the rear.

2. When the oven door opens, do not drag the container over the door window, and the load on the door should not exceed 3.5 kg.
3. Do not place the microwave oven on a shelf directly above a gas or electric hob. This may be a safety hazard and the oven may be damaged.
4. Do not block air vents on the oven. If air vents are blocked during operation, the oven may overheat. If the oven overheats, a thermal safety device will turn the oven off. The oven will remain inoperable with blank display until it has cooled.
5. This appliance is intended to be used in household applications only.

Care & Cleaning of Your Oven



Important

It is essential for the safe operation of the oven that it is kept clean, and wiped out after each use. Failure to maintain the oven in a clean condition could lead to deterioration of a surface that could adversely affect the life of the appliance and possibly result in a hazardous situation.

1. **Switch the oven off before cleaning** and unplug at the socket if possible.
2. **Keep the inside of the oven, door seals and door seal areas clean.**
When food splatters or spilled liquids adhere to oven walls, door seals and door seal areas wipe off with a damp cloth. Mild detergent may be used if they get very dirty. The use of harsh detergent or abrasives is not recommended.

Care & Cleaning of Your Oven

3. After using **Grill, Oven, Steam,** and **Combination** cooking the walls of the oven should be cleaned with a soft cloth and soapy water. Particular care should be taken to keep the window area clean especially after cooking by **Grill, Oven, Steam,** and **Combination**. Stubborn spots inside the oven can be removed by using a small amount of conventional oven-cleaner sprayed onto a soft damp cloth. Wipe onto problem spots, leave for recommended time and then wipe off. **Do not spray directly inside the oven.**
4. After cooking with a **steam function**, wipe away any excess water which may have condensed within the oven cavity. Empty the drip tray (refer to page 20).
5. Do not use harsh abrasive cleaners or sharp metal scrapers to clean the **oven door glass** since they may scratch the surface, which may result in shattering of the glass.
6. The **outside oven surface** should be cleaned with a damp cloth. To prevent damage to the operating parts inside the oven, water should not be allowed to seep into the ventilation openings.
7. If the **control panel** becomes dirty, clean with a soft, dry cloth. **Do not** use harsh detergents or abrasives on control panel. When cleaning the control panel, leave the oven door open to prevent the oven from accidentally turning on. After cleaning tap **Stop/Cancel** pad to clear the display window.
8. **If steam accumulates** inside or around the outside of the oven door, wipe with a soft cloth. This may occur when the microwave oven is operated under high humidity conditions and in no way indicates a malfunction of the unit or microwave leakage.
9. The **oven cavity floor** should be cleaned regularly. Simply wipe the bottom surface of the oven with mild detergent and warm water then dry with a clean cloth. Cooking vapours collect during repeated use but in no way affect the bottom surface.
10. When **Grilling** or cooking by **Oven, Steam or Combination** some foods may splatter grease onto the oven walls. If the oven is not cleaned to eliminate this grease, it can accumulate and cause the oven to '**smoke**' during use. These marks will be more difficult to clean later.

Care & Cleaning of Your Oven

11. A **steam cleaner** is not to be used for cleaning the appliance.
12. Ensure the Grill Tray is kept clean, especially when using **Combination** programs.
13. Keep **air vents** clear at all times. Check that no dust or other material is blocking any of the air vents on the oven. If vents become blocked this could cause overheating which would affect the operation of the oven and possibly result in a hazardous situation.
14. Run the system cleaning program when the symbol shows in the display. See pages 91-92. Clean the water tank at least once a week to prevent build up of limescale. See page 94.

Maintenance of Your Oven

Service

1. **When your oven requires a service** call your local Panasonic engineer (**Customer Communications Centre on 0344 844 3899** can recommend an engineer).



Warning!

It is hazardous for anyone other than a competent person to carry out any service or repair operation which involves the removal of a cover which gives protection against exposure to microwave energy.

Door Seals

2. Do not attempt to tamper with or make any adjustments or repairs to door, control panel housing, safety interlock switches or any other part of the oven. Do not remove outer panel from oven which gives protection against exposure to microwave energy. The door seals and door seal areas should always be kept clean – use a damp cloth.



Warning!

The appliance should be inspected for damage to the door seals and door seal areas. If the door or door seals are damaged, the oven must not be operated until it has been repaired by a competent person.

Maintenance of Your Oven

Water Tank

3. Do not use the water tank if it is cracked or broken, as leaking water could result in electrical failure and danger of electric shock. If the water tank becomes damaged, please contact your dealer.

Oven Light

4. The oven lamp must be replaced by a service technician trained by the manufacturer. **Do not** attempt to remove the outer casing from the oven.

Selected Spares and Accessories

5. These may be ordered directly on line at **www.panasonic.co.uk** or by telephoning the **Customer Communication Centre on 0344 844 3899**. Most major credit and debit cards accepted. Ensure you quote the correct model number.

Accessory Advice

1. Do not cook food directly on the base of the oven. Always place food in a microwave safe dish.
2. The Grill Tray provided must **only** be used as directed for **Grill, Oven, Steam** and **Combination**. **Never use metal accessories when cooking in microwave only mode**. Do not use if operating the oven with less than 200 g of food on a manual combination program. The maximum weight that can be used on the oven accessory is 3.2 kg. Failure to use the accessory correctly could damage your oven.
3. When cooking with **microwave** power arcing may occur if the incorrect weight of food is used, a metal container has been used incorrectly, or the oven accessory has been damaged. If this occurs, stop the appliance immediately. You can continue to cook by **Grill, Steam** or **Oven** only.
4. Always refer to instructions for correct accessory to use on all auto programs.

Oven Accessory



















The oven comes equipped with an accessory, the Grill Tray. Always follow the directions given for use of the accessory.

The accessory has a number of uses:



Grill Tray

- Do not pre-heat.
- **Always use oven gloves when handling the hot tray.**
- Ensure all food packaging is removed before cooking.
- Do not place any heat-sensitive materials on the hot tray as this may cause burning.
- For correct use of the Grill Tray for each cooking mode, see pages 35-37.

Cooking modes	Grill Tray	Position
 Microwave	×	-
 Grill	✓	
 Oven	✓	
 Steam	✓	
 +  Combi 1,2	✓	
 +  Combi 3,4	✓	
 +  Combi 5	✓	
 +  Combi 6	✓	

Care of the Grill Tray

1. Never use any sharp utensils on the tray as this will damage the non-stick surface.
2. After use, wash the tray in hot soapy water and rinse in hot water. Do not use any abrasive cleaning substances or scouring pads as this will damage the surface of the tray.
3. **The Grill Tray is dishwasher safe.**

Parts of Your Oven

Front View

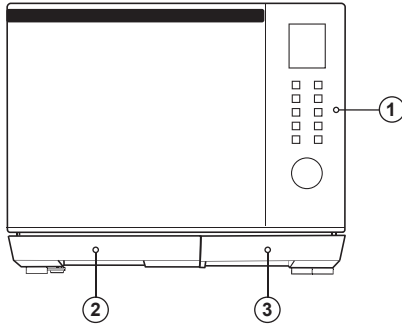

1. Control panel
2. Drip tray
3. Water tank

Rear View

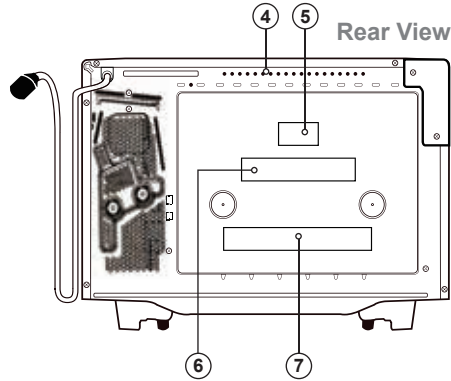

4. Air vent exhaust
5. Warning label
6. Information label
7. Identification label



Drip Tray

1. Before using the oven, the drip tray must be fitted as it collects excess water during cooking. The drip tray should be removed and cleaned on a regular basis.
2. Fit the drip tray by holding with both hands and clicking onto the front legs of the oven.
3. To remove the drip tray, hold with both hands and gently ease forward. Wash in warm soapy water. Re-position the drip tray by clicking back onto the legs.
4. **Do not use a dishwasher to clean the drip tray.**

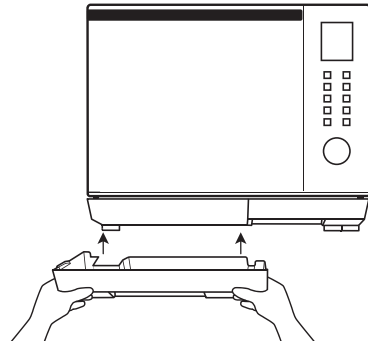

Re-position the drip tray by clicking back onto the legs.

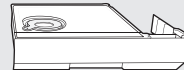

Water Tank

1. Refer to guidelines for water tank on page 53.
2. **Do not use a dishwasher to clean the water tank.**

Note

The above illustration is for reference only.

Parts of Your Oven

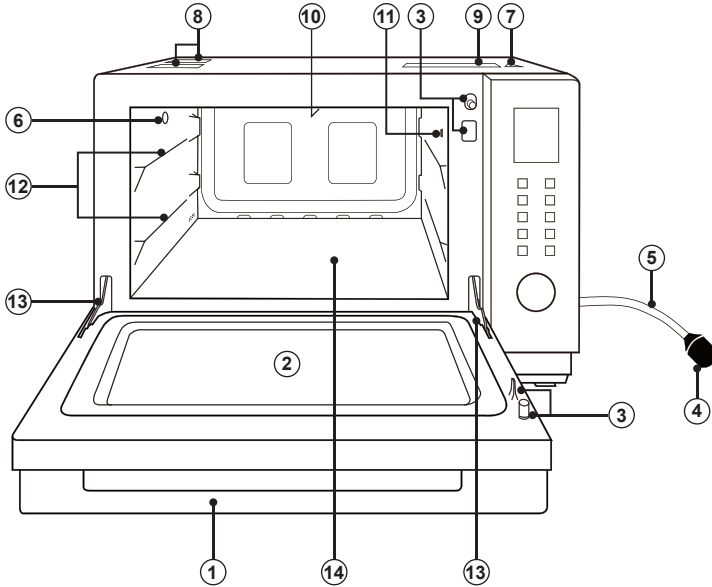

① **Door handle**

Pull the door handle downwards to open. When you open the oven door during cooking, the cooking is stopped temporarily without clearing the programmed settings. The cooking is resumed as soon as the door is closed and the Dial is pressed. The oven lamp lights as soon as the oven door is opened.

② **Oven window**

③ **Door safety lock system**

To prevent injury, do not insert finger, knife, spoon or other object into the latch hole.

④ **Power supply plug**

⑤ **Power supply cord**

⑥ **Steam outlets**

⑦ **Warning symbol**

⑧ **Warning label**

⑨ **Menu label**

Position your supplied menu label.

⑩ **Grill elements**

⑪ **LED lights**

The oven lamp lights as soon as the oven door is opened.

⑫ **Shelf positions**

⑬ **Door hinges**

To prevent injury when opening or closing the door, keep fingers away from the door hinges.

⑭ **Bottom microwave feeding**

(refer to page 43)

Note

The above illustration is for reference only.

Important Information

Safety

If smoke is emitted or a fire occurs in the oven, tap **Stop/Cancel** pad and leave the door closed in order to stifle any flames. Disconnect the power cord, or shut off power at the fuse or the circuit breaker panel.

Short Cooking Times

As microwave cooking times are much shorter than other cooking methods it is essential that recommended cooking times are not exceeded without first checking the food.

Cooking times given in the charts are approximate. Factors that may affect cooking times are: preferred degree of cooking, starting temperature, altitude, volume, size and shape of foods and utensils used. As you become familiar with the oven, you will be able to adjust these factors.

It is better to initially undercook rather than overcook foods. If food is undercooked, it can always be returned to the oven for further cooking. If food is overcooked, nothing can be done. Always start with minimum cooking times.



Important

If the recommended cooking times are exceeded the food will be spoiled and in extreme circumstances could catch fire and possibly damage the interior of the oven.

Small Quantities of Food

Take care when heating small quantities of food as these can easily burn, dry out or catch fire if cooked too long. Always set short cooking times and check the food frequently.



Note

Never operate the oven without food inside on **Microwave** or **Combination** mode involving microwave.

Food Low in Moisture

Take care when heating foods low in moisture, e.g. bread items, chocolate, biscuits and pastries. These can easily burn, dry out or catch on fire if cooked too long. We do not recommend heating foods low in moisture such as popcorn or poppadoms. The microwave oven is intended for heating food and beverages only. Drying of food, newspapers or clothing and heating of warming pads, slippers, sponges, damp cloth, wheat bags, hot water bottles and similar may lead to risk of injury, ignition or fire.

Christmas Pudding

Christmas puddings and other foods high in fats or sugar, e.g. jam, mince pies, must not be overheated. These foods must never be left unattended as with over cooking these foods can ignite.

Important Information

Boiled Eggs

Eggs in their shell and whole hardboiled eggs should not be heated in microwave ovens since they may explode even after microwave heating has ended.

Foods with Skins

Potatoes, apples, egg yolk, whole vegetables and sausages are examples of food with non porous skins. These must be pierced using a fork before cooking to prevent bursting.



Warning!

Liquids and other foods must not be heated in sealed containers since they are liable to explode.

Liquids

When heating liquids, e.g. soup, sauces and beverages in your microwave oven, overheating the liquid beyond boiling point can occur without evidence of bubbling.

This could result in a sudden boil over of the hot liquid. To prevent this possibility the following steps should be taken:

- Avoid using straight-sided containers with narrow necks.
- Do not overheat.
- Stir the liquid before placing the container in the oven and again halfway through the heating time.

- After heating, allow to stand in the oven for a short time, stirring again before carefully removing the container.

Microwave heating of beverages can result in delayed eruptive boiling, therefore care should be taken when handling the container.

Lids

Always remove the lids of jars and containers and takeaway food containers before you microwave them. If you don't then steam and pressure might build up inside and cause an explosion even after the microwave cooking has stopped.

Deep Fat Frying

Do not attempt to deep fat fry in your oven.

Meat Thermometer

Use a meat thermometer to check the degree of cooking of roasts and poultry only when meat has been removed from the microwave. If undercooked, return to the oven and cook for a few more minutes at the recommended power level. Do not leave a conventional meat thermometer in the oven when microwaving.

Important Information

Paper, Plastic

When heating food in plastic or paper containers, keep an eye on the oven due to the possibility of ignition. Do not use wire twist-ties with roasting bags when cooking mode includes microwave power as arcing will occur. Do not use recycled paper products, e.g. Kitchen roll unless they say they are specifically designed for use in a microwave oven. These products contain impurities which may cause sparks and/or fires when used.

Reheating

It is essential that reheated food is served “piping hot”. Remove the food from the oven and check that it is “piping hot”, i.e. steam is being emitted from all parts and any sauce is bubbling. (If you wish you may choose to check the food has reached 72 °C with a food thermometer – but remember do not use this thermometer inside the microwave.)

For foods that cannot be stirred, e.g. lasagne, shepherds pie, the centre should be cut with a knife to test it is well heated through. Even if a manufacturer’s packet instructions have been followed always check the food is piping hot before serving and if in doubt return your food to the oven for further heating.

Standing Time

Standing time refers to the period at the end of cooking or reheating when food is left before being eaten, i.e. it is a rest time which allows the heat in the food to continue to conduct to the centre, thus eliminating cold spots.

Keeping Your Oven Clean

It is essential for the safe operation of the oven that it is wiped out regularly. Use warm soapy water, squeeze the cloth out well and use to remove any grease or food from the interior. Pay particular attention to the door seal area. The oven should be unplugged when cleaning.

Grilling

The oven will only operate on the **Grill** function with the door closed.

Fan Motor Operation

After using the microwave oven, the fan motor may operate to cool the electric components. This is normal and you can take out food even though the fan motor operates. You can continue using the oven during this time.

Important Information

Utensils/Containers

Before use check that utensils/containers are suitable for use in microwave ovens. See pages 33-34.

Storage of Accessories

Do not store any objects other than oven accessory inside the oven in case it is accidentally turned on.

Babies Bottles and Food Jars

When reheating babies bottles always remove top and teat. Liquid at the top of the bottle will be much hotter than that at the bottom and must be shaken thoroughly before checking the temperature. The lid must also be removed from babies food jars,

the contents must also be stirred or shaken before the temperature is checked. This should be carried out before consumption in order to avoid burns. See pages 95-96.

Arcing

Arcing may occur if a metal container has been used incorrectly, if the incorrect weight of food is used, or if the accessories have been damaged. Arcing is when blue flashes of light are seen in the microwave oven. If this occurs, stop the machine immediately. If the oven is left unattended and this continues it can damage the machine. You can continue to cook by **Grill, Oven or Steam only**.

Microwaving Principles

Microwaves are present in the atmosphere all the time, both naturally and from manmade sources. Manmade sources include radar, radio, television, telecommunication links and mobile phones.

In a microwave oven, electricity is converted into microwaves by the **Magnetron**. For bottom feeding, please refer to page 43.

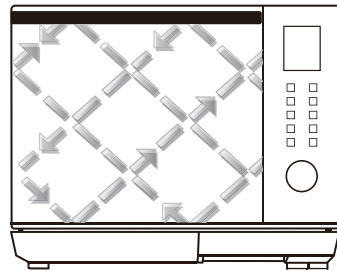
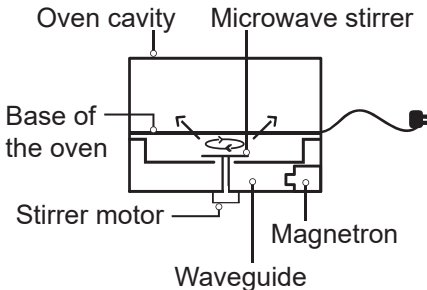

Microwaving Principles

Reflection

The microwaves bounce off the metal walls and the metal door screen.

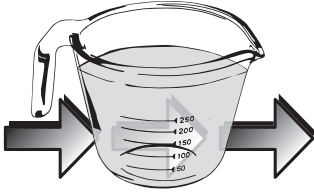

Transmission

Then they pass through the cooking containers to be absorbed by the water molecules in the food, all foods contain water to a more or lesser extent.

foods high in these will cook more quickly. Microwaves can only penetrate to a depth of 4-5 cm and as heat spreads through the food by conduction, just as in a traditional oven, the food cooks from the outside inwards.

Foods Not Suitable for Cooking by Microwave Only

Yorkshire pudding and souffles. This is because these foods rely on dry external heat to cook correctly, do not attempt to cook by microwave.

Foods that require deep fat frying cannot be cooked either.



Important Notes

The dish used to cook or reheat the food will get warm during cooking, as the heat conducts from the food. Even in microwaving, oven gloves are required! **Microwaves can not pass through metal and therefore metal cooking utensils can never be used in a microwave, for cooking on microwave only.**

Standing Time

When a microwave oven is switched off, the food will continue to cook by conduction – **not by microwave energy**. Hence **standing time** is very important in microwaving, particularly for dense foods i.e. meat, cakes and reheated meals (refer to page 29).

How Microwaves Cook Food

The microwaves cause the water molecules to vibrate which causes **friction**, i.e. **heat**. This heat then cooks the food.

Microwaves are also attracted to fat and sugar particles, and



Boiled eggs

Do not boil eggs in your microwave. Raw eggs boiled in their shells can explode and cause serious injury.

Control Panel

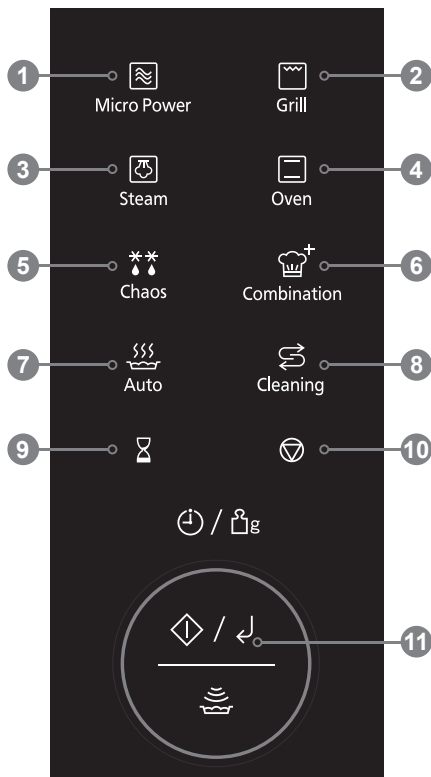

1. **Micro Power** (pages 42-43)
2. **Grill** (pages 47-48)
3. **Steam** (pages 52-55)
4. **Oven** (pages 49-51)
5. **Chaos Defrost** (pages 87-89)
6. **Combination** (pages 56-60)
7. **Auto Cook** (pages 70-86)
8. **Cleaning** (pages 90-93)
9. **Timer/Clock**
(pages 39, 64-67)
10. **Stop/Cancel**
Before cooking:
One tap clears your instructions.
During cooking:
One tap temporarily stops the cooking program. Another tap cancels all your instructions and a colon or the clock will appear in the display.
11. **Dial** (page 28)



Beep sound

A beep sounds when a key is tapped. If this beep does not sound, you may have turned off the beep choice, you can turn it on by turning the dial after first plugged in, (see page 40). When the oven changes from one function to another or remind you to stir food during cooking, two beeps sound. After the completion of the preheating on grill, oven, or certain combination mode, three beeps sound. After completion of the preheating on some auto menus, a long beep sounds. After completion of cooking, five beeps sound.



Note

If an operation is set and the **Dial** is not pressed within 6 minutes, the oven will automatically cancel the operation. The display will revert back to colon or clock mode.

How to Use the Dial

The Dial has the following 4 functions:



Turn the **Dial**

1 Time/Weight//Temperature/Menu Selection
Select the time, weight, temperature or auto menu by turning the **Dial**.

2 Add Time
Use the **Dial** for the add time function (see page 68).



Press the **Dial**

3 Start/Set
Press the **Dial** to start operating the oven or confirm the setting. If during cooking the door is opened or **Stop/Cancel** is tapped once, the **Dial** has to be pressed again to continue cooking.

4 One Push Reheating
When clock or colon is displayed, press the **Dial** for quick start reheating chilled meal. (see page 69)

Display Window

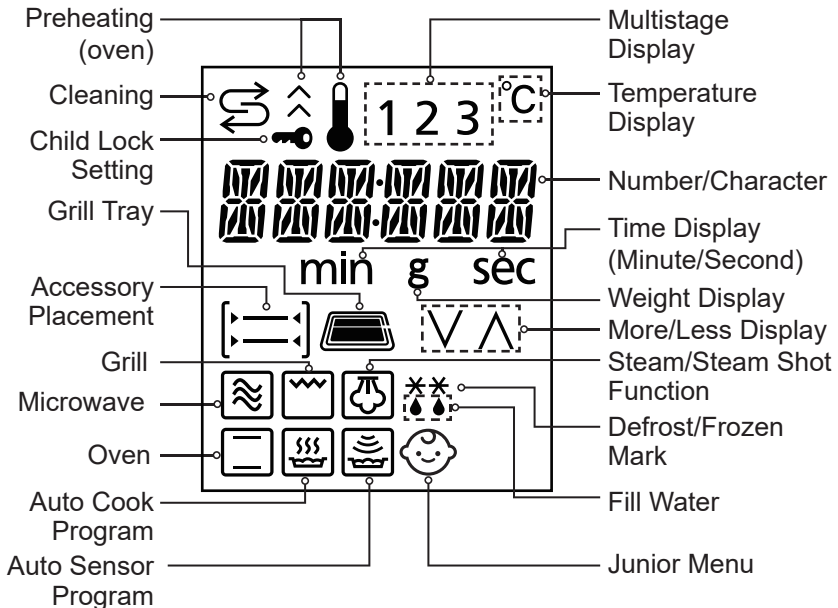

General Guidelines

Standing Time

Dense foods e.g. meat, jacket potatoes and cakes, require a **standing time** (inside or outside of the oven) after cooking, to allow heat to finish conducting through the food.

■ Jacket Potatoes

Wrapped in aluminium foil when cooked by microwave only. Stand for 15 minutes. It is not necessary to stand jacket potatoes cooked in **combination** mode.

■ Fish

Stand for 2-3 minutes.

■ Egg Dishes

Stand for 1-2 minutes.

■ Precooked Convenience Food

Stand for 1-2 minutes.

■ Meat Joints

Stand for 15 minutes wrapped in aluminium foil.

■ Plated Meals

Stand for 2-3 minutes.

■ Vegetables

Boiled potatoes benefit from standing for 1-2 minutes, however most other types of vegetables can be served immediately.

■ Defrosting

It is essential to allow standing time to complete the process. This can vary from 5 minutes e.g. raspberries, to up to 1 hour for a joint of meat. See pages 45-46.

If food is not cooked after **standing time**, return to oven and cook for additional time.



Moisture Content

Many fresh foods e.g. vegetables and fruit, vary in their moisture content throughout the season. Jacket potatoes are a particular example of this. For this reason cooking times may have to be adjusted throughout the year. Dry ingredients e.g. rice, pasta, can dry out during storage so cooking times may differ from ingredients freshly purchased.



Piercing

The skin or membrane on some foods will cause steam to build up during cooking. These foods must be pierced or a strip of skin should be peeled off before cooking to allow the steam to escape. Eggs, potatoes, apples, sausages etc, will all need to be pierced before cooking. Do not **attempt to boil eggs in their shells**.

General Guidelines



Cling Film

Cling film helps keep the food moist and the trapped steam assists in speeding up cooking times. However it should be pierced before cooking, to allow excess steam to escape. Always take care when removing cling film from a dish as the build-up of steam will be very hot. Always purchase cling film that states on the packet “suitable for microwave cooking” and use as a covering only. Do not line dishes with cling film. Do not cover foods when cooking by **Grill, Oven** or **Combination**.



Dish Size

Follow the dish sizes given in the recipes, as these affect the cooking and reheating times. A quantity of food spread in a bigger dish cooks and reheats more quickly.



Quantity

Small quantities cook faster than large quantities, also small meals will reheat more quickly than large portions.



Spacing

Foods cook more quickly and evenly if spaced apart. Never pile foods on top of each other.



Shape

Even shapes cook evenly. Food cooks better by microwave when in a round container rather than square.



Density

Porous airy foods heat more quickly than dense heavy foods.



Covering

Cover foods with microwave cling film or a self-fitting lid. Cover fish, vegetables, casseroles, soups. Do not cover cakes, sauces, jacket potatoes, pastry items. Please refer to cooking charts and recipes for more information.

General Guidelines



Arranging

Individual foods e.g. chicken portions or chops, should be placed in a dish so that the thicker parts are to the outside.



Ingredients

Foods containing fat, sugar or salt heat up very quickly. The filling may be much hotter than the pastry. Take care when eating. Do not overheat even if the pastry does not appear to be very hot.



Starting Temperature

The colder the food, the longer it takes to heat up. Food from a fridge takes longer to reheat than food at room temperature. Food temperature should be between 5-8 °C before cooking.



Turning and Stirring

Some foods require stirring during cooking. Meat and poultry should be turned after half the cooking time.



Liquids

All liquids must be stirred **before, during and after heating**. Water especially must be stirred before and during heating, to avoid eruption. Do not heat liquids that have previously been boiled. **Do not overheat.**



Checking Food

It is essential that food is checked during and after a recommended cooking time, even if an **auto program** has been used (just as you would check food cooked in a conventional oven). Return the food to the oven for further cooking if necessary.



Cleaning

As microwaves work on food particles, keep your oven clean at all times. Stubborn spots of food can be removed by using a branded oven cleaner, sprayed onto a soft cloth. Always wipe the oven dry after cleaning. Avoid any plastic parts and door area. Customers should not spray directly into the cavity.

Quick Check Guide to Cooking Utensils



Choosing the correct container is a very important factor in deciding the success or failure of your cooking.

Testing Dishes for Suitability - For Microwave Cooking Only.

When unsure that a cooking container is suitable for use in your microwave, check by the following test:

1. Fill a microwave safe measuring jug with 300 ml cold water.
2. Place it on the base of the oven along side the dish to be tested. If the dish you are testing is a large dish, then stand the measuring jug on top of the empty dish.
3. Heat on **High Microwave (1000 W)** for 1 minute.



Result

If the dish is suitable for microwaving, it will remain cool, whilst the water in the jug will begin to feel warm. If the testing dish feels warm, do not use as it is obviously absorbing microwave energy.



Note

This test does not apply to plastic or metal based containers e.g. Le Creuset® style dishes, which should not be used as they are cast iron covered with enamel.

Containers to Use



Oven Glass

Everyday glass that is heat resistant e.g. Pyrex[®], is ideal for Microwave, Oven or Combination cooking. Do not use delicate glass or lead crystal which may crack or arc.



China and Ceramic

Everyday glazed china, porcelain or ceramic plates, bowls, mugs and cups can be used if they are heat resistant. Fine bone china should only be used for reheating for short periods. Do not use dishes with a metal rim or pattern. Do not use jugs or mugs with glued handles, since the glue can melt. If dishes are heat resistant they may be used on Oven and Combination but not directly under the Grill.



Pottery, Earthenware, Stoneware

If completely glazed, these dishes are suitable. Do not use if partially glazed or unglazed, since they are able to absorb water which in turn absorbs microwave energy, making the container very hot and slows down the cooking of food.



Foil/Metal Containers

Never attempt to cook in foil or metal containers on Microwave only as the microwaves cannot pass through and the food will not heat evenly, it may also damage your oven. Foil and metal containers can be used on Grill or Oven.



Plastic

Many plastic containers are designed for microwave use, but do not use for cooking foods high in sugar or fat or for foods that require long cooking times e.g. brown rice. Only use Tupperware[®] containers if they are designed for Microwave use.



Do not use Melamine. Never cook in margarine cartons or yoghurt pots,

as these will melt with the heat from the food. If heatproof they can be used for Grill, Oven or Combination cooking.

Containers to Use



Paper

Plain white absorbent kitchen paper (kitchen towel) can only be used for microwave cooking e.g. for covering bacon to prevent splattering.

Only use for short cooking times. Never re-use a piece of kitchen towel. Always use a fresh piece of paper for each dish.

Avoid kitchen paper containing manmade fibres. If you are using branded re-cycled kitchen towel, check first that it is recommended for microwave use. Do not use waxed or plastic coated cups or plates as the finish may melt. Greaseproof paper can be used to line the base of dishes and to cover when blind baking pastry cases. White paper plates can be used for **short reheating times**, on Microwave only.



Wicker, Wood, Straw Baskets

Dishes will crack and could ignite. Do not use wooden dishes in your microwave. **Do not use on any cooking mode.**



Cling Film

Microwave cling film can only be used for covering food that is reheated by microwave. It is also useful for covering food to be cooked, but care should be taken to avoid the film being in direct contact with the food eg. Do not line dishes with cling film. **Do not use on any other cooking mode.**



Aluminium Foil

Small amounts of smooth aluminium foil can be used to shield joints of meat during defrosting and cooking by Microwave, as the microwaves cannot pass through the foil, this prevents the parts shielded from overcooking or over defrosting. Take care that the foil does not touch the sides or roof of the oven, as this may cause arcing and damage your oven. Aluminium foil can be used for Oven cooking.





Roasting Bags

Roasting bags are useful when slit up one side to tent a joint, for roasting by microwave and time. Do not use the metal twists supplied, when using Microwave or Combination.





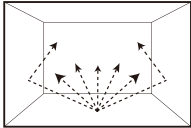
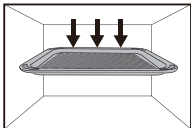

Cooking Modes

The diagrams shown below are examples of the accessory. It may vary depending on recipe/dish used.

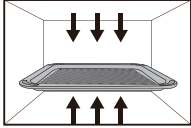

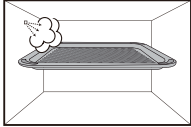

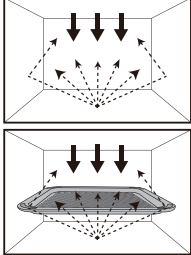

The icon "  " in below chart means **Grill Tray**.

Cooking modes		
<p>MICROWAVE</p>  <p>Accessory -</p>	<p>Uses</p>	<ul style="list-style-type: none"> ■ Defrosting ■ Reheating ■ Melting: butter, chocolate, cheese. ■ Cooking fish, vegetables, fruits, eggs. ■ Preparing: stewed fruits, jam, sauces, custards, choux, pastry, caramel, meat, fish. ■ Baking cakes without colour. <p>No preheating</p>
	<p>Containers</p>	<p>Use your own Pyrex® dishes, plates or bowls, directly on the base of the oven. Microwaveable, no metal.</p>
<p>GRILL</p>  <p>Accessory </p>	<p>Uses</p>	<ul style="list-style-type: none"> ■ Grilling of meat or fish. ■ Toast grilling. ■ Colouring of gratin dishes or meringue pies.
	<p>Containers</p>	<p>Heatproof, metal tin can be used on Grill Tray in lower or upper shelf positions.</p>

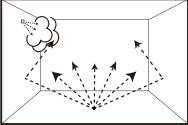
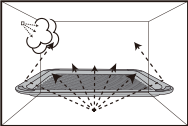
Cooking Modes

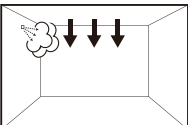
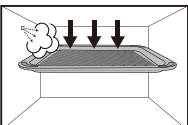
Cooking modes	
<p style="text-align: center;">OVEN</p>  <p style="text-align: center;">Accessory</p> 	<p style="text-align: center;">Uses</p> <ul style="list-style-type: none"> ■ Baking of small items with short cooking times: puff pastry, cookies, roll cakes, scones. ■ Special baking: bread rolls or brioches, sponge cakes. ■ Baking of pizzas and tarts. <p style="text-align: center;">Preheating advised</p> <hr/> <p style="text-align: center;">Containers</p> <p>Heatproof, metal tin can be used on Grill Tray in lower or upper shelf positions. Do not place dishes directly on base of oven.</p>
<p style="text-align: center;">STEAM</p>  <p style="text-align: center;">Accessory</p> 	<p style="text-align: center;">Uses</p> <ul style="list-style-type: none"> ■ Cooking fish, vegetables, chicken, rice, and potatoes. <p style="text-align: center;">No Preheating</p> <hr/> <p style="text-align: center;">Containers</p> <p>Heatproof container can be used on Grill Tray in upper or lower shelf positions.</p>
<p style="text-align: center;">Combi 1, 2 (Grill + Microwave)</p>  <p style="text-align: center;">Accessory</p> 	<p style="text-align: center;">Uses</p> <ul style="list-style-type: none"> ■ Cooking lasagne, meat, potatoes or vegetable gratins. <p style="text-align: center;">No Preheating</p> <hr/> <p style="text-align: center;">Containers</p> <p>Place food directly on Grill Tray in upper or lower shelf positions or place food in a microwaveable dish on the base of the oven.</p>

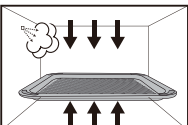
Cooking Modes

Cooking modes		
<p>Combi 3, 4 (Steam + Microwave)</p>   <p>Accessory</p> 	<p>Uses</p> <p>Containers</p>	<ul style="list-style-type: none"> ■ Cooking fish, vegetables, chicken, rice, and potatoes. <p>No Preheating</p> <p>Place food directly on Grill Tray in upper or lower shelf positions or place food in a microwaveable dish on the base of the oven.</p>
<p>Combi 5 (Steam + Grill)</p>   <p>Accessory</p> 	<p>Uses</p> <p>Containers</p>	<ul style="list-style-type: none"> ■ Gratins ■ Kebabs ■ Fish fillets ■ Whole fish ■ Part baked bread <p>No Preheating</p> <p>Heatproof dishes can be used on the Grill Tray in the lower or upper shelf positions or directly on the base of the oven.</p>
<p>Combi 6 (Steam + Oven)</p>  <p>Accessory</p> 	<p>Uses</p> <p>Containers</p>	<ul style="list-style-type: none"> ■ Baking cakes ■ Pastry tarts <p>Preheating advised</p> <p>Heatproof dishes can be used on the Grill Tray in the lower or upper shelf positions. Do not place dishes directly on base of oven.</p>

Let's Start to Use Your Oven

1

Plug in.

Plug into a 13 amp fused electrical socket. You will be reminded to read your operating instructions.

2



Tap Timer/Clock pad twice to set clock.

Set clock as a 24 hr clock. (See page 39 for details).

3



Select 220 °C Oven to burn off the oil.

( will appear in the display window with the oven temperature) (this procedure is to burn off the oil used for rust protection in the oven.) Remove all accessories from the oven. (See page 49 for details)

4



Enter Time.

Turn the **Dial** until 10 minutes is displayed in the window.

5



Press the Dial to start.

The time in the display will count down. The oven will beep at the end of the program. The oven is now ready to use.



Caution!

Grill elements and oven will be hot.



Note

This is to enable you to experiment setting various programs. ("DEMO MODE PRESS ANY KEY" will appear in the display window. This is to confirm that there is no microwave power produced and it is safe to use the oven without any food). To set Demonstration Mode: Tap **Micro Power** pad once, then tap **Stop/Cancel** pad 4 times. To cancel demonstration mode: Tap **Micro Power** pad once, tap **Stop/Cancel** pad 4 times.

Setting the Clock

When the oven is first plugged in, "REFER TO OPERATING INSTRUCTIONS BEFORE USE" appears in display window.

1



Tap Timer/Clock pad twice.
"SET HOUR" appears in the display window.

2



Turn the Dial to select the hour.

3



Press the Dial to confirm the selection.
"SET MIN" appears in the display window.

4



Turn the Dial to select the minute.

5



Press the Dial to confirm the selection.
The colon stops blinking. Time of day is now locked into the display.



Note

1. To reset the time of day repeat all the above steps.
2. The clock will keep the time of day as long as the oven is plugged in and electricity is supplied.
3. This is a 24 hour clock.

Beep Choice

The oven has both "Beep On" and "Beep Off" mode. This unique function of your Panasonic microwave oven allows you to establish the initial non-cooking features of your oven.

1



Press the Dial after first plugged in.
"BEEP ON/OFF" scrolls across display window. The default mode is "ON".

2



Turn the Dial.
The mode changes to "OFF".

3



After setting, tap Stop/Cancel pad to exit.



Note

1. The choice can be selected only when you plug-in the oven.
2. Tap **Stop/Cancel pad**, it will revert to initial mode.

Child Lock

Using this system will make the oven controls inoperable; however, the door can be opened. Child lock can be set when the display shows a colon or the time.

1



Tap Stop/Cancel pad 3 times.

The time of day or colon will disappear. Actual time will not be lost. "🔑" is indicated in the display.

2



Tap Stop/Cancel pad 3 times.

The time of day or colon will reappear in the display.



Note

To activate or cancel child lock, **Stop/Cancel** pad must be tapped 3 times within a 10 second period. Child Lock can be set when a colon or the time of day is displayed.

Operation Guide Setting

To assist you in programming your oven, the following operation will appear in the display window. When you become familiar with your oven, the operation guide can be turned off.

To turn off:



OPERATION GUIDE OFF



Colon or time of day appears in the display window.

Tap **Timer/Clock** pad 4 times.

Display window

To turn on:



OPERATION GUIDE ON



Colon or time of day appears in the display window.

Tap **Timer/Clock** pad 4 times.

Display window





Microwave Cooking and Defrosting

There are 7 different microwave power levels available. Do not place food directly on the base of the oven. Use your own dishes, plates or bowls covered with a lid or pierced cling film directly on the base of the oven.

1



Tap Micro Power pad once.

The microwave symbol "  " will appear. When you select Defrost, "  " will also appear.

2



Select the power level.

Turn the **Dial** until the power you require appears in the display window.

Power Level
High (1000 W)
Med High (800 W)
Medium (600 W)
Low (440 W)
Simmer (300 W)
Defrost (270 W)
Warm (100 W)

3



Press the Dial to confirm the selection.

4



Select the cooking time by turning the Dial.

Maximum cooking time for High is 30 minutes, and for other power levels, it is 1 hour 30 minutes.

5



Press the Dial to start.

The cooking program will start and the time in the display will count down.



Microwave Cooking and Defrosting



Note

1. You can change the cooking time during cooking if required. Turn the **Dial** to increase or decrease the cooking time. Time can be increased/decreased in 1 minute increments, up to 10 minutes.
2. Do not attempt to use microwave only with any metal container in the oven.
3. Do not place food directly onto the base of the oven. Place in a microwaveable or glass dish. Foods reheated or cooked by microwave only should be covered with a lid or pierced cling film, unless otherwise stated.
4. For manual defrosting times, please refer to defrost chart on pages 45-46.
5. For multi-stage cooking refer to pages 61-63.
6. Standing time can be programmed after microwave power and time setting. Refer to using the timer pages 66-67.

Bottom feeding technology

Please note that this product uses bottom feeding technology for microwave distribution which differs from traditional turntable side feeding methods and creates more useable space for a variety of different sized dishes.

This microwave feeding style can give a difference in heating times (in microwave mode) when compared against side feeding appliances.

This is quite normal and should not cause any concern. Please refer to the reheating and cooking charts on pages 97-112.



Defrosting Guidelines

By selecting the **Defrost** power level from the **Micro power** pad and setting a time, you can defrost food in your microwave. The biggest problem is getting the inside defrosted before the outside starts to cook.

For this reason a defrost program alternates between a defrost power and a standing time. The name for this type of defrost is cyclic. During the standing stages there is not any microwave power in the oven, although the light will remain on.

The automatic standing time ensure a more even defrost but it is still necessary to allow for standing times before use.

For Best Results

1. Place foods in a suitable container. Meat joints and chickens should be placed on an upturned saucer or on a plastic rack if you have one.
2. Check food during defrosting, as foods vary in their defrosting speed.
3. It is not necessary to cover the food.
4. Always turn or stir the food especially when the oven "beeps". Shield if necessary (see point 6).
5. Minced meat, chops, chicken portions and other small items should be broken up or separated as soon as possible and placed in a single layer.

6. Shielding prevents food cooking. It is essential when defrosting chickens and joints of meat. The outside thaws out first, so protect wings/breast and fat with smooth pieces of aluminium foil secured with cocktail sticks.
7. Allow standing time so that the centre of the food thaws out. (Minimum of 1 hour for joints of meat and whole chickens).



Arrange food in a single layer.



Turn or break up food as soon as possible.



Shield chickens and joints of meat.



Defrosting Charts

The times given below are a guideline only. Always check the progress of the food by opening the oven door and then re-starting. For larger quantities adjust times accordingly. Food should not be covered during defrosting.

Food	Weight	Defrost Time	Method	Standing Time
Meat				
Beef/Lamb/ Pork Joint	700 g	19-20 mins	Place in a suitable dish or on an upturned saucer or use a rack. Turn 3-4 times.	60 mins
	1.0 kg	30 mins	Place in a suitable dish or on an upturned saucer or use a rack. Turn 4 times.	60 mins
Sirloin/ Rump Steak	500 g	14 mins	Place in a suitable dish. Separate and turn twice.	15 mins
Minced Beef	500 g	14 mins	Place in a suitable dish. Break up and turn 3-4 times.	15 mins
Stewing Steak	400 g	13 mins	Place in a suitable dish in a single layer. Break up and turn twice.	30 mins
Lamb Chops	300 g	8 mins	Place in a suitable dish in a single layer. Turn twice.	15 mins
Lamb Shanks x 2	900 g	19 mins	Place in a suitable dish in a single layer. Separate and turn twice. Shield if necessary.	60 mins
Pork Ribs	700 g	16 mins	Place in a suitable dish. Separate and turn twice.	30 mins
Pork Chops	500 g	11 mins	Place in a suitable dish. Separate and turn twice.	20 mins
Sausages	130 g (2)	4 mins	Place in a suitable dish. Turn.	15 mins
	540 g (8)	10-11 mins	Place in a suitable dish. Turn twice.	20 mins
Whole Chicken	1.5 kg	35 mins	Place in a suitable dish or on an upturned saucer or use a rack. Turn 3-4 times. Shield if necessary.	60 mins



Defrosting Charts

Food	Weight	Defrost Time	Method	Standing Time
Duck Breast Fillets	400 g	12 mins	Place in a suitable dish. Turn twice.	30 mins
Fish				
Whole Fish x 2	500 g	15 mins	Place in a suitable dish. Turn twice separate if necessary.	20 mins
Fish Fillets	100-150 g	4-5 mins	Place in a suitable dish. Separate if necessary and turn twice.	10 mins
	600 g	10 mins		30 mins
Fish Steaks	100 g	4 mins	Place in a suitable dish. Turn.	10 mins
	270 g	8 mins	Place in a suitable dish.	15 mins
	500 g	12-14 mins	Separate if necessary and turn twice.	20 mins
Prawns	200 g	7 mins	Place in a suitable dish. Stir twice during defrosting.	15 mins
General				
Sliced Bread	400 g	6 mins	Place on a plate. Separate and arrange during defrosting.	10 mins
	40 g	1 min 30 secs	Place on a plate.	5 mins
Soft Fruit	500 g	13 mins	Place in a suitable dish. Stir twice during defrosting.	30 mins
Gateau	515 g	4 mins	Place on a plate.	20 mins
Cheesecake	500 g	7 mins	Place on a plate.	20 mins
Meringue Dessert	450 g	4 mins	Place on a plate.	20 mins
Butter	250 g	4 mins	Place on a plate.	20 mins
Shortcrust/Puff Pastry	500 g	4 mins	Place on a plate. Turn halfway.	30 mins
Chocolate Cake	450 g	4-6 mins	Place on a plate.	15 mins



Grilling

The grill system on the oven gives fast efficient cooking for a wide variety of foods e.g. chops, sausages, steaks, toast, etc. Do not pre-heat on grill mode with the Grill Tray in position.

1



Tap Grill pad once.

2



Select the power level.

Turn the **Dial** until the power you require appears in the display window.

Grill 1 (High), Grill 2 (Medium), Grill 3 (Low).

3



Press the Dial to confirm the selection.

4



Press the Dial to preheat.

A "P" will appear in the display window.

When the oven is preheated the oven will beep and the "P" will flash. Then open the door and place the food inside.

*** Skip this step when preheat is not required.**

5



Select the cooking time by turning the Dial.

Maximum cooking time is 1 hour and 30 minutes.

6



Press the Dial to start.

The cooking program will start and the time in the display will count down.



Grilling

Oven Accessory to Use

When grilling fish, chops or small food items, the Grill Tray should be placed in the upper shelf position. For larger food items, the Grill Tray should be in the lower shelf position.

Place food on Grill Tray

The Grill Tray will allow fat and juices to drip into the watercourse to reduce excess splatter and smoke when grilling.

Most foods require turning halfway during cooking. When turning food, open oven door and carefully remove the Grill Tray by holding firmly.

After turning, return food to the oven, close door and press the **Dial** to start. The oven will continue to count down the remaining cooking time. It is quite safe to open the oven door at any time to check the progress of the food as it is grilling.



For grilling small foods use the Grill Tray in the upper shelf position.

Guidelines

1. You can change the cooking time during cooking if required. Turn the Dial to increase or decrease the cooking time. Time can be increased/ decreased in 1 minute increments, up to 10 minutes.
2. There is no microwave power on the **Grill** only program.
3. Use the Grill Tray provided, as explained.
4. The **Grill** will only operate with the oven door closed.
5. Most meat items e.g. bacon, sausages, chops can be cooked on the hottest setting **Grill 1**. This setting is also suitable for toasting bread, muffins and teacakes etc.
6. **Grill 2** and **Grill 3** are used for more delicate foods or those that require a longer grill time e.g. fish or chicken portions.
7. **Never cover the food when grilling.**
8. The Grill Tray and surrounding oven will get very hot. Use oven gloves.
9. After grilling, it is important that the Grill Tray is removed for cleaning before reuse and that the oven walls and floor are wiped with a cloth squeezed in hot soapy water to remove any grease.
10. When using the grill to cook foods, the cooking times will be similar to traditional grilling.

Oven Cooking

The oven can be used as an oven using the oven mode which uses top and bottom heat. For best results always place food in a preheated oven. When using oven mode, the Grill Tray can be placed in the upper or lower shelf position.

See individual guidelines on pages 50-51 for recommended use.
Do not pre-heat on oven mode with the Grill Tray in position.

1



Tap Oven pad once.

2



Select the oven temperature.

Turn the **Dial** to select the oven temperature. The oven starts at 150 °C and the temperature will count up in 10 °C stages up to 220 °C then back to 30 °C in anticlockwise direction.

3



Press the Dial to confirm the selection.

4



Press the Dial to preheat.

(except for 30-60 °C)

When the actual temperature reaches the set temperature, the oven will beep. Then open the door and place the food inside.

*** Skip this step when preheat is not required.**

5





Select the cooking time by turning the Dial.

Maximum cooking time for 30-90 °C is 9 hours, and for 100-220 °C, it is 1 hour and 30 minutes.

6



Press the Dial to start.

Note: Check that only the oven symbol " " is still in the display. If the microwave symbol " " is displayed this is incorrect and the program should be cancelled. Reselect the oven setting.

Oven Cooking



Note

1. If the oven has previously been used and it is too hot to ferment dough on 30/40 °C, 'HOT' will appear in the display window. Please wait until the cavity cools down. After the 'HOT' disappears, 30/40 °C may be used again, otherwise you can ferment dough at room temperature.
2. Open the door using the pull down door because if **Stop/Cancel** pad is tapped the program may be cancelled.
3. The oven can not preheat to 30-60 °C.
4. You can change the cooking time during cooking if required. Turn the **Dial** to increase or decrease the cooking time. Time can be increased/decreased in 1 minute increments, up to 10 minutes.
5. When preheating, the screen displays the actual temperature of the oven cavity. The current temperature is not displayed until more than 70 °C is reached. You can change the preheating temperature by turning the **Dial**.
6. After pressing the **Dial**, the selected temperature can be recalled and changed. Tap **Oven** pad once to indicate the temperature in the display window. You can change the temperature by turning the **Dial** While the temperature is recalled in the display window.
7. The oven will maintain the selected preheated temperature for approximately 30 minutes. If no food has been placed inside the oven or a cooking time set, then it will automatically cancel the cooking program and revert to colon or time of day.

In oven mode, you can cook food directly on the Grill Tray in the upper or lower shelf position. Or you can place your standard metal baking tins and ovenware on the Grill Tray in the lower shelf position. Do not place tins and ovenware directly on the base of the oven in oven mode.

Roasting meat:

Grill Tray in lower shelf position.



Baking:

Grill Tray in lower shelf position.



Oven Cooking

You can use the Grill Tray for baking dish for roasting potatoes or vegetables, and for baking fairy cakes, scones and cookies. It is also ideal for re-heating pre-baked convenience pastry items.

Roasting Vegetables / Potatoes:

Grill Tray in lower shelf position.



Reheating:

Grill Tray in lower shelf position.



Caution!

The Grill Tray and surrounding oven will get very hot. Use oven gloves.

Guideline to Oven Temperatures

For best results always place food in a preheated oven.

Don't forget that for ease of programming of the most commonly used temperatures, your oven will start at 150 °C and count up in 10 °C stages to 220 °C then back to 30 °C in anticlockwise direction. Food is generally cooked uncovered - unless it is stated in the instructions or recipe.

Temp °C	Use
30/40 °C	Proving bread or pizza dough
50 °C	Warming dishes
60/70 °C	Dried fruits, beef jerky
80/90 °C	Slow cooking
100 °C	Pavlova
110 °C	Meringues
140 °C	Rich fruit cake
150/160 °C	Macaroons
160/170 °C	Casseroles, small tarts, cookies
180 °C	Victoria sandwich, fairy cakes, meat joints

Temp °C	Use
190 °C	Gratins, lasagne, pastry pies, chicken
200 °C	Stuffed peppers, scones, swiss roll, muffins
210 °C	Vegetable parcels, bread, garlic bread
220 °C	Baking pizza, low-oil oven fry cooking for drumsticks, pork chops, and sweet potatoes etc.



Steam Cooking

The oven can be programmed as a steamer to cook vegetables, fish, chicken and rice. There are 2 different steam settings available: Steam 1 (max) and Steam 2 (low).

1



Tap **Steam** pad once.

2



Select the power level.

Turn the **Dial** until the power you require appears in the display window.
Steam1 (max), Steam 2 (low).

3



Press the **Dial** to confirm the selection.

4



Select the cooking time by turning the **Dial**.
Maximum cooking time is 30 minutes.

5



Press the **Dial** to start.

The cooking program will start and the time in the display will count down.



Note

1. Fill the water tank before using the **Steam** function.
2. The maximum time for cooking in this mode is 30 minutes. If required to cook for longer than this time, re-fill the water tank and repeat the above operation for the remaining time.
3. If during operation the water tank becomes empty, the oven will stop operation. The prompt in the display will ask you to re-fill the water tank. After re-filling the water tank and positioning back in the oven, press the **Dial** to start. The oven will not continue cooking until the water tank has been re-filled and the **Dial** pressed.



Steam Cooking



Note

4. You can change the cooking time during cooking if required. Turn the **Dial** to increase or decrease the cooking time. Time can be increased/decreased in 1 minute increments, up to 10 minutes.
5. It is possible to refill the water tank at any time during cooking, without having to tap **Stop/Cancel** pad first.
6. It is necessary to wipe the excess water in the cavity after steam cooking.



Caution!

1. The Grill Tray and surrounding oven will get very hot. Use oven gloves.
2. When removing the food or Grill Tray, hot water may drip from the oven top.
3. Steam may billow out when you open the door. If there is steam in the oven, do not reach in with your bare hands! Risk of burns! Use oven gloves.
4. Take care when removing the drip tray. Wipe any water that drips from the left side of the oven. This is normal.

Guidelines for Water Tank

Carefully remove the water tank from the oven. Remove the lid and fill with tap water (do not use mineral water). Replace the lid and position back in the oven. Ensure the lid is closed tightly and securely positioned, otherwise leakage may occur. It is recommended to clean the water tank in warm water once a week.

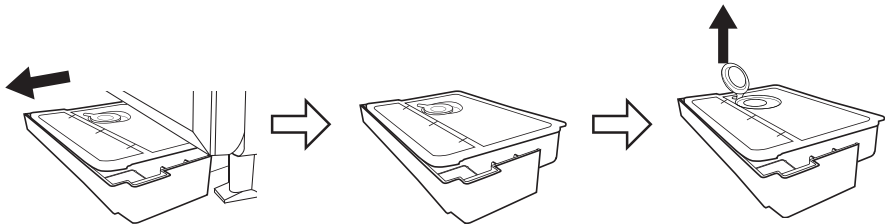



Steam Cooking



Guidelines

1. There is no microwave power on the steam only program.
2. Use the Grill Tray provided, as explained below.
3. The **steam** will only operate with the oven door closed.
4. **During and after cooking with steam function, do not open the oven door when your face is very close to the oven. Care must be taken when opening the door as steam may cause injury.**
5. Always use oven gloves when removing the food and Grill Tray after steaming as they will be very hot.
6. After each steam operation, carefully remove the drip tray from the front of the oven. Gently ease forwards, holding with both hands. After emptying, wash in warm soapy water. To re-position, click back into position on the oven legs. (See page 20)

Use of accessory

When **steaming**, place food directly on the Grill Tray in the upper shelf position. For steaming larger food items, place the Grill Tray in the lower shelf position. During steaming, cooking juices collect in the watercourse of the tray.

Use oven gloves when removing the Grill Tray as it will be very hot, and so will the roof and walls of the oven.



*When **steaming**, place food directly on the Grill Tray in the upper shelf position.*



Steam Shot

This feature allows you to add steam during cooking (up to 3 minutes). Adding steam during cooking enhances the heat distribution and aids the rising process of breads, cakes and pastries. There are 5 modes that you can use steam shot:

Microwave, Grill, Oven, Combi 1, Combi 2.

1

Set and operate the desired program.

2



As required during operation, hold Steam pad for 2 seconds and 1 minute will be added.

3



Optional

If you want to add 2 or 3 minutes, tap Steam pad once or twice within 3 seconds after step 2. The remaining time displayed includes steam shot time.



Note

1. Steam shot is not available during preheating mode.
2. Fill the water tank before use.
3. The original program still counts down when operating steam shot.
4. The steam shot time can not exceed the remaining cooking time.
5. If adding 2 or 3 minutes, steam must be tapped once or twice within a 3 second time period.
6. Wipe away excess water in the cavity and around the water tank after cooking with steam.



Caution!

1. The Grill Tray and surrounding oven will get very hot. Use oven gloves.
2. When removing the food or Grill Tray, hot water may drip from the oven top.
3. Steam may billow out when you open the door. If there is steam in the oven, do not reach in with your bare hands! Risk of burns! Use oven gloves.

Food	Cooking mode	Steam Shot
Puff pastries	Oven	$\frac{2}{3}$ total time add 3 mins Steam Shot
Breads	Oven	$\frac{2}{3}$ total time add 3 mins Steam Shot
Sponge cakes	Oven	$\frac{1}{2}$ total time add 3 mins Steam Shot
Part baked rolls	Oven or Grill	$\frac{2}{3}$ total time add 3 mins Steam Shot



Combination: Grill and Microwave

On the base of the oven in your own microwaveable and heatproof dishes, this mode is suitable for cooking lasagne, gratins, meat, potatoes.

To cook successfully by this **combination** you should always use a minimum of 200 g food. Small quantities should be cooked by **oven, grill or steam**. It is not possible to preheat when using this combination mode and food should always be cooked uncovered.

Combination Level	Combination Type	Uses
Combi 1	Grill 1 + MW 300 W (Simmer)	Breaded chicken, ready meal with gratin tops, meat pies and pastries.
Combi 2	Grill 2 + MW 300 W (Simmer)	

1



Tap **Combination** pad once.

2



Turn the **Dial** until the power you require appears in the display window.
(Skip this step for **Combi 1**)

3



Press the **Dial** to confirm the selection.

4



Select the **cooking time** by turning the **Dial**.
Maximum cooking time is 1 hour and 30 minutes.

5



Press the **Dial** to start.
The cooking program will start and the time in the display will count down.



Combination: Grill and Microwave



Note

1. Preheating is not available for **Combi 1, 2**.
2. You can change the cooking time during cooking if required. Turn the **Dial** to increase or decrease the cooking time. Time can be increased/decreased in 1 minute increments, up to 10 minutes.
3. To turn food just pull the door handle downwards to open, turn the food, return to the oven, close the door and press the **Dial** to start. The oven will continue to count down the remaining cooking time.

For advice on cooking times refer to cooking and reheating charts in this book. See pages 97-112. Foods should always be cooked until browned and piping hot.



You can use the Grill Tray in either of the shelf positions.



Caution!

Your dishes and surrounding oven will get very hot. Use oven gloves.



Guideline

Food is always cooked uncovered.



Containers to use

Do not use plastic microwave containers on combination programs (unless suitable for combination cooking). Dishes must be able to withstand the heat of the top grill elements- heatproof glass e.g. Pyrex® or ceramic are ideal.



Combination: Cooking with Steam

Steam can be used to cook foods simultaneously with microwave, grill or oven mode. This can often reduce traditional oven cooking times and keep the food moist.

Combination Level	Combination Type	Uses
Combi 3	Steam 1 + MW 300 W (Simmer)	Stewed fruit, fresh vegetables, frozen vegetables
Combi 4	Steam 1 + MW 440 W (Low)	
Combi 5	Steam 1 + Grill 1	Fish and chicken with skin
Combi 6	Steam 1 + Oven (150 - 220°C)	Home-made bread

1



Tap **Combination** pad once.

2



Turn the **Dial** until the power you require appears in the display window.

3



Press the **Dial** to confirm the selection.

4



Turn the **Dial** to select the oven temperature (**Combi 6 only**).
Temperature ranges from 150-220 °C

5



Press the **Dial** to confirm the selection.
(**Combi 6 only**)



Combination: Cooking with Steam

6



Tap if preheating (Combi 6 only)

When the actual temperature reaches the set temperature, the oven will beep. Then open the door and place the food inside.

*** Skip this step when preheating is not required.**

7



Select the cooking time by turning the Dial.

Maximum cooking time for **Combi 3,4** is 30 minutes and maximum cooking time for **Combi 5,6** is 1 hour.

8



Press the Dial to start.

The cooking program will start and the time in the display will count down.

Oven accessory to Use:



Combi 3,4: Steam + Microwave

Directly on the base of the oven in a microwaveable and heatproof dish or alternatively you can use the Grill Tray in either of the shelf positions.



Combi 5: Steam + Grill

Combi 6: Steam + Oven

Grill Tray in either of the shelf positions.



Note

1. Fill the water tank before using **steam combination** function.
2. The maximum time for cooking in **Combi 3, 4** is 30 minutes and maximum time for **Combi 5, 6** is 1 hour. If required to cook for longer than this time, re-fill the water tank and repeat the above operation for the remaining time.



Combination: Cooking with Steam



Note

3. If during operation the water tank becomes empty, the oven will stop operation. The prompt in the display will ask you to re-fill the water tank. After re-filling the water tank and positioning back in the oven, press the **Dial** to start. The oven will not continue cooking until the water tank has been re-filled and the **Dial** pressed.
4. Preheating is only available For **Combi 6**.
5. You can change the cooking time during cooking if required. Turn the **Dial** to increase or decrease the cooking time. Time can be increased/decreased in 1 minute increments, up to 10 minutes.
6. It is possible to refill water tank at any time during cooking, without having to tap **Stop/Cancel** pad first.
7. It is necessary to wipe the excess water in the cavity after **steam combination** cooking.



Guidelines

1. During and after cooking with **steam combination** function, do not open the oven door when your face is very close to the oven. Care must be taken when opening the door as steam may cause injury.
2. After each steam operation, carefully remove the drip tray from the front of the oven. Gently ease forwards, holding with both hands. After emptying, wash in warm soapy water. To re-position, click back into position on the oven legs. (See page 20).



Caution!

1. The Grill Tray and surrounding oven will get very hot. Use oven gloves.
2. When removing the food or Grill Tray, hot water may drip from the oven top.
3. Steam may billow out when you open the door. If there is steam in the oven, do not reach in with your bare hands! Risk of burns! Use oven gloves.
4. Take care when removing the drip tray.

Multi-stage Cooking

2 or 3 stage cooking

1 Select desired Function.



2 Turn the Dial until the power you require appears in the display window.



3 Press the Dial to confirm the selection.



4 Select the cooking time by turning the Dial.

5 Select desired Function.



6 Turn the Dial until the power you require appears in the display window.



7 Press the Dial to confirm the selection.



8 Select the cooking time by turning the Dial.



9 Press the Dial to start. The cooking program will start and the time in the display will count down.

Multi-stage Cooking

Example: To **Grill 3** for 4 minutes and cook food on **Low Power (440 W)** for 5 minutes.

1



Tap Grill pad once.

2



Turn the Dial to select Grill 3 (Low).

3



Press the Dial to confirm the selection.

4



Select the cooking time to 4 minutes by turning the Dial.

5



Tap Micro Power pad once.

6



Turn the Dial to select Low Microwave (440 W).

7



Press the Dial to confirm the selection.

8



Select the cooking time to 5 minutes by turning the Dial.

9



Press the Dial to start. The cooking program will start and the time in the display will count down.

Multi-stage Cooking

Example: To **Defrost (270 W)** for 2 minutes and cook food on **High Power (1000 W)** for 3 minutes.

1



Tap **Micro Power** pad once.

2



Turn the **Dial** to select **Defrost** power.

3



Press the **Dial** to confirm the selection.

4



Select the cooking time to 2 minutes by turning the **Dial**.

5



Tap **Micro Power** pad once.

6



Press the **Dial** to confirm the selection.

7



Select the cooking time to 3 minutes by turning the **Dial**.

8



Press the **Dial** to start.



Note

1. For three-stage cooking, enter another cooking program before pressing the **Dial**.
2. During operation, tapping **Stop/Cancel** pad once will stop the operation. pressing the **Dial** will re-start the programmed operation. Tapping **Stop/Cancel** pad twice will stop and clear the programmed operation.
3. Whilst not operating, tapping **Stop/Cancel** pad will clear the selected program.
4. **Auto programs, Oven and Combi 5, 6** cannot be used with multi-stage cooking.
5. If multiple cooking includes **Steam** or **Steam Combination** mode, the maximum setting time is 30 minutes. Fill water tank before use.

Using the Timer

Delay start cooking

By using the timer, you are able to program delay start cooking.

1



Tap Timer/Clock pad once.

2



Set the delay time by turning the Dial.
(up to 9 hours).

3

Set the cooking program, by entering
cooking mode and time required.

4



Press the Dial to start.



Note

1. Three-stage cooking can be programmed including delay start cooking.
2. If the oven door is opened during the delay time, the time in the display window will continue to count down.
3. If the programmed delay time exceeds one hour, the time will count down in units of minutes. If less than one hour, the time will count down in units of seconds.
4. Delay start cannot be used before an auto program.

Using the Timer

Delay start cooking

Example:

Delay start: 1 hour, High Power (1000 W): 10 mins, Simmer Power (300 W): 20 mins.

1



Tap Timer/Clock pad once.

2



Set the delay time to 1 hour by turning the Dial.

3



Tap Micro Power pad once.

4



Press the Dial to confirm the selection

5



Set the cooking time to 10 minutes by turning the Dial.

6



Tap Micro Power pad once.

7



Turn the Dial to select Simmer Power (300 W)

8



Press the Dial to confirm the selection

9



Set the cooking time to 20 minutes by turning the Dial.

10



Press the Dial to start.

Using the Timer

To set a standing time:

By using the Timer, you can program Standing time after cooking is completed or use to program the oven as a minute timer.

1

Select Cooking Mode & Time

Set the cooking program, by entering cooking mode and time required.

2



Tap Timer/Clock pad once.

3



Set the standing time by turning the Dial.
(up to 9 hours).

4



Press the Dial to start.



Note

1. Three-stage cooking can be programmed including standing time.
2. If the oven door is opened during the standing time or minute timer, the time in the display window will continue to count down.
3. If the programmed standing time exceeds one hour, the time will count down in units of minutes. If less than one hour, the time will count down in units of seconds.
4. This feature may also be used as a minute timer. In this case tap the **Timer/Clock**, set time and press the **Dial** to start.
5. Standing time cannot be used after an auto program.

Using the Timer

To set a standing time:

Example:

High Power (1000 W): 4 mins, Standing time: 5 mins, High Power (1000 W): 2 mins

1



Tap Micro Power pad once.

2



Press the Dial to confirm the selection.

3



Set the cooking time to 4 minutes by turning the Dial.

4



Tap Timer/Clock pad once.

5



Set the standing time to 5 minutes by turning the Dial.

6



Tap Micro Power pad once.

7



Press the Dial to confirm the selection.

8



Set the cooking time to 2 minutes by turning the Dial.

9



Press the Dial to start.

Using the Add Time Function

This feature allows you to add cooking time at the end of previous cooking.

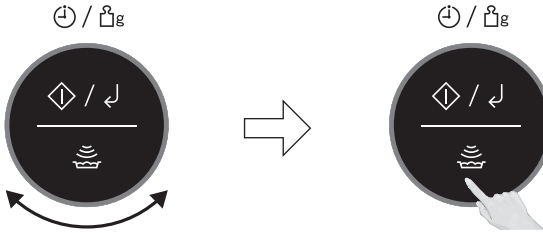

After cooking, turn the **Dial** to select **Add Time** function.

Press the Dial to start.

Time will be added. The time in the display window will count down.

Modes	Maximum cooking time
Micro Power 1000 W, Steam	30 minutes
Other microwave powers, Grill	1 hour and 30 minutes
Oven (30-90 °C), Timer	9 hours
Oven (100 - 220 °C)	1 hour and 30 minutes
Combination 1,2	1 hour and 30 minutes
Combination 3,4	30 minutes
Combination 5,6	1 hour



Note

1. This function is only available for **Micro Power, Grill, Oven, Steam, Combination** and **Timer** functions and it is not available for Auto programs.
2. The Add Time function is only available within 1 minute after cooking.
3. The Add Time function can be used after the multi-stage cooking. The power level is the same as the last stage.





One Push Reheating

This unique feature 'the Genius' built in sensor allows you to reheat a chilled meal with one push of the **Dial**. It is not necessary to select the power level or cooking time. The built-in sensor measures the humidity of the food and calculates the microwave power level together with a cooking time.

When clock or colon is displayed, press the Dial to start.

To reset oven and return to clock or colon, tap **Stop/Cancel pad**.



Program	Weight*/ Placement	Instructions
Reheat a fresh pre-cooked chilled meal  	200 - 1000 g Base of oven	To reheat a chilled pre-cooked meal . All foods must be pre-cooked and at refrigerator temperature approx. +5 °C. Reheat in container as purchased. Pierce covering film with a sharp knife once in the center and four times around the edge. If transferring food to dish, cover with pierced cling film. Place container on base of oven. Press Dial to start the program. Stir at beeps. Stir again at end of program and allow a few minutes standing time. Large pieces of meat/fish in a thin sauce may require longer cooking. This program is not suitable for starchy food such as rice, noodles or potatoes. Meals in irregular bowl shaped containers may need longer cooking.

* Recommend weight range



Note

Press the **Dial** in two minutes right after the door was closed, otherwise One Push Reheating Function will be rejected and beeps will sound. Open the door and close it again will release the One Push Reheating Function.



Sensor Reheat Programs

the Genius sensor

This unique feature allows you to simply reheat a frozen meal. It is not necessary to select the power level, weight or cooking time. The built-in sensor measures the humidity of the food and calculates the microwave power level together with a cooking time.

1



Tap Auto Cook pad once.

2







Press the Dial to confirm the program.

3



Press the Dial to start.

No.	Program	Weight*/ Placement	Instructions
1	Frozen Meal    	200 - 1000 g Base of oven	To reheat a frozen pre-cooked meal. All foods must be pre-cooked and frozen (-18 °C). Reheat in container as purchased. Pierce covering film with a sharp knife once in the center and four times around the edge. If transferring food to dish, cover with pierced cling film. Place container on base of oven. Select program number 1. Start to cook. Stir at beeps and cut any blocks into pieces. Stir again at end of program and allow a few minutes standing time. Large pieces of meat/fish in a thin sauce may require longer cooking. This program is not suitable for starchy food such as rice, noodles or potatoes. Meals in irregular bowl shaped containers may need longer cooking.

* Recommend weight range



How it Works

Once the Sensor Reheat Program has been selected and **the Dial** is pressed the food is heating up. As food begins to get hot, steam is emitted. When the food reaches a certain temperature and begins to cook, an even greater amount of steam is released. The increase in steam emission is detected by a humidity sensor in the oven. This acts as a signal for the oven to calculate how much longer the food needs to reheat. The remaining cooking time will appear in the display window after two beeps. Whilst the sensor program is still in the display window the oven door **should not be opened**. Wait until the cooking time appears in the window, and then open the door if required, to stir or turn the food.

Adjust to Taste

The Sensor Reheat Program reheats a chilled meal or a frozen meal for average tastes. You are able to adjust the Sensor Reheat Program to your own taste. After pressing the **Dial**, " √ / ^ "symbol appears in the display, turn **Dial** clockwise for more time or anticlockwise for less time. This operation should be completed within 14 seconds. Default mode is normal.



Note

1. This feature is not suitable for foods that cannot be stirred eg. lasagne / macaroni cheese.
2. The oven automatically calculates the reheating time or the remaining reheating time.
3. The door should not be opened before the time appears in the display window.
4. To prevent any mistakes during Sensor Reheat Programs ensure that base of oven and the container are dry.
5. The room temperature should not be more than 35 °C and not less than 0 °C.
6. If the oven has previously been used and it is too hot to be used on Sensor Reheat Programs, 'HOT' will appear in the display window. After the 'HOT' disappears, the Sensor Reheat Programs may be used. If in a hurry, cook food manually by selecting the correct cooking mode and cooking time yourself.



Auto Steam Programs

This feature allows you to steam some of your favourite foods by setting the weight only. The oven determines the steam level and the cooking time automatically. Select the category and set the weight of the food. The weight is programmed in grams. For quick selection, the weight starts from the minimum weight for each category.

1



Tap Auto Cook pad once.

2



Turn the Dial to select the food category.
(No. 2-8)

3



Press the Dial to confirm the selection.

4



Select the weight.
Select the weight by turning the Dial. It will count up in 10 g steps.

5



Press the Dial to start.
The cooking program will start and the time in the display will count down.

When you select an automatic program, symbols will appear in the display to show the cooking mode that will be used and if the Grill Tray is needed. See below to identify the symbols:



Grill Tray



Steam







Auto Steam Programs



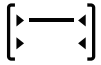

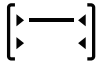

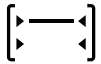



Guidelines for Use

1. The auto steam programs must only be used for foods described.
2. Only cook foods within the weight ranges described.
3. Always weigh the food rather than relying on the package weight information.
4. Always use the Grill Tray as indicated.
5. For larger weights on the auto steam programs chicken breasts and rice, it will be necessary to re-fill the water tank during cooking.
6. Do not cover foods on the auto steam programs.
7. Most foods benefit from a standing time after cooking on an auto program, to allow heat to continue conducting to the centre.
8. To allow for some variations that occur in food, check that food is thoroughly cooked and piping hot before serving.
9. The temperature for frozen food is assumed to be -18 °C to -20 °C. The temperature of chilled food is assumed to be +5 °C to +8 °C (refrigerator temperature).
10. If 'HOT' appears in the display window, the oven temperature is too high from previous use and an auto program can not be set. Cooking mode and time may still be set manually.

No.	Program	Weight/ Placement	Instructions
2	Fresh Vegetables 	200 - 500 g 	To steam fresh vegetables e.g. carrots, broccoli, cauliflower, green beans. Fill water tank. Place prepared vegetables onto Grill Tray. Place in the upper shelf position. Select program number 2. Enter the weight of the fresh vegetables. Start to cook.
3	Frozen Vegetables 	200 - 400 g 	To steam frozen vegetables e.g. carrots, broccoli, cauliflower, green beans. Fill water tank. Place vegetables onto Grill Tray. Place in the upper shelf position. Select program number 3. Enter the weight of the frozen vegetables. Start to cook.
4	Steamed Potatoes 	200 - 500 g 	To steam potatoes. Fill water tank. Peel potatoes and cut into even sized pieces. Place prepared potatoes onto Grill Tray. Place in the upper shelf position. Select program number 4. Enter the weight of the potatoes. Start to cook.



Auto Steam Programs

No.	Program	Weight/ Placement	Instructions
5	Chicken Breasts 	200 - 650 g 	To cook fresh chicken breasts. Each chicken breast should weigh between 150-200 g each. Fill water tank. Place chicken breasts onto Grill Tray. Place in the upper shelf position. Select program number 5. Enter the weight of the chicken breasts. Start to cook. Check water level during cooking and re-fill as necessary. Allow to stand for a few minutes after cooking.
6	Fresh Fish Fillets 	200 - 500 g 	To cook fresh fish fillets e.g. salmon, cod, haddock, plaice. Fill water tank. Place fresh fish onto Grill Tray. Place in the upper shelf position. Select program number 6. Enter the weight of the fresh fish. Start to cook. Allow to stand for a few minutes after cooking.
7	Frozen Fish Fillets 	200 - 500 g 	To cook frozen fish fillets e.g. salmon, cod, haddock. Fill water tank. Place frozen fish onto Grill Tray. Place in the upper shelf position. Select program number 7. Enter the weight of the frozen fish. Start to cook. Allow to stand for a few minutes after cooking.
8	Rice 	100 - 200 g 	For cooking rice for savoury dishes (Thai, Basmati, Jasmine, long grain), not pudding rice. Rinse the rice in cold water. Fill water tank. Place rice in a shallow Pyrex® dish. Add 1 part cold water to 1 part rice. Do not cover. Place dish onto Grill Tray. Place in the upper shelf position. Select program number 8. Enter the weight of the rice only. Start to cook. Check water level during cooking and re-fill as necessary.



Healthy Grill & Fries Programs

This feature allows you to cook some of your favourite foods by setting the weight only. Select the category and set the weight of the food. The weight is programmed in grams. For quick selection, the weight starts from the minimum weight for each category.

1



Tap Auto Cook pad once.

2



Turn the Dial to select the food category.
(No.9-13)

3



Press the Dial to confirm the selection.

4



Press the Dial to start preheating
(No.12 only).

A "P" will appear in the display window. When the oven is preheated the oven will beep and the "P" will flash. Then open the door and place the food inside.

*** Skip this step when preheating is not required.**

5



Select the weight by turning the Dial.
The Dial will count up in 10 g steps.

6



Press the Dial to start.

The cooking program will start and the time in the display will count down.



Healthy Grill & Fries Programs

When you select an automatic program, symbols will appear in the display to show the cooking mode that will be used and if the Grill Tray is needed. See below to identify the symbols:



Grill Tray



Micro Power



Steam



Grill







Oven











Guidelines

1. These programs must only be used for foods described.
2. Only cook foods within the weight ranges described.
3. Always weigh the food rather than relying on the package weight information.
4. The temperature for frozen food is assumed to be $-18\text{ }^{\circ}\text{C}$ to $-20\text{ }^{\circ}\text{C}$. The temperature of chilled food is assumed to be $+5\text{ }^{\circ}\text{C}$ to $+8\text{ }^{\circ}\text{C}$ (refrigerator temperature).
5. Always use the Grill Tray as indicated.
6. Most foods benefit from a standing time after cooking on an auto program, to allow heat to continue conducting to the centre.
7. To allow for some variations that occur in food, check that food is thoroughly cooked and piping hot before serving.
8. If 'HOT' appears in the display window, the oven temperature is too high from previous use and an auto program can not be set. Cooking mode and time may still be set manually.

No.	Program	Weight/ Placement	Instructions
9	Fresh Fish Fillets    	200 - 800 g 	To cook fish fillets for one side grill e.g. salmon, cod, haddock weighing a maximum 220 g each. Fill water tank. Brush skin side with oil. Place fresh fish, skin side down, onto Grill Tray. Place in the lower shelf position. Select program number 9. Enter the weight of the fresh fish. Start to cook.



Healthy Grill & Fries Programs

No.	Program	Weight/ Placement	Instructions
10	Fresh Whole Fish 	200 - 650 g 	To cook fresh whole fish e.g trout, sea bream, mackerel, sea bass, sardines weighing between 100 g - 400 g each. Place whole fish directly onto Grill Tray. Before cooking non-oily fish (sea bass, trout), brush with oil. Place in the upper shelf position. Select program number 10. Enter the weight of the fresh whole fish. Start to cook.
11	Vegetable Fries 	100 - 350 g 	For preparing fresh vegetable fries such as sweet potato, white potato, carrots, parsnips and courgettes. Peel and cut the vegetables into baton shapes. Toss in a tablespoon of vegetable oil each 100 g fries. Place onto Grill Tray in upper shelf position. Select program number 11. Enter the weight of the vegetable fries. Start to cook.
12	Frozen Potato Fries 	200 - 500 g 	To cook frozen potato fries. Select program number 12. Tap start to preheat the oven. Spread potato fries out onto Grill Tray. After preheated, enter the weight of the frozen potato fries. Place Grill Tray in upper shelf position. Start to cook. For best results cook in a single layer. Note: Potato fries vary considerably. We suggest checking a few minutes before the end of cooking to assess level of browning. This program is suitable for $\frac{3}{8}$ inch fries.
13	Chicken Wings and Drumsticks 	200 - 600 g 	To cook chicken wings and drumsticks. Clean the wings and marinate for about 20 minutes with seasonings you prefer. Place onto Grill Tray in upper shelf position. Select program number 13. Enter the weight of the chicken wings and drumsticks. Start to cook.



Auto Cook Programs

1



Tap Auto Cook pad once.

2



Turn the Dial to select the food category.
(No.14-17)

3



Press the Dial to confirm the selection.

4



Select the weight by turning the Dial.
The Dial will count up in 10 g steps. Skip this
step for program No. 17.

5



Press the Dial to start.
The cooking program will start and the time in
the display will count down.

When you select an automatic program, symbols will appear in the display to show the cooking mode that will be used. See below to identify the symbols:



Grill Tray



Micro Power



Grill







Auto Cook Programs



Guidelines

1. The auto cook programs must only be used for foods described.
2. Only cook foods within the weight ranges described.
3. Always weigh the food rather than relying on the package weight information.
4. The temperature for frozen food is assumed to be -18 °C to -20 °C. The temperature of chilled food is assumed to be +5 °C to +8 °C (refrigerator temperature).
5. The Grill Tray is not used on auto cook program 17. Dish is placed directly on the base of the oven.
6. Most foods benefit from a standing time after cooking on an auto program, to allow heat to continue conducting to the centre.
7. To allow for some variations that occur in food, check that food is thoroughly cooked and piping hot before serving.
8. If 'HOT' appears in the display window, the oven temperature is too high from previous use and an auto program can not be set. Cooking mode and time may still be set manually.

No.	Program	Weight/ Placement	Instructions
14	Jacket Potatoes 	250 - 1000 g 	To cook jacket potatoes with a crisper drier skin. Choose medium sized potatoes 250 g -300 g per potato, for best results. Wash and dry potatoes and prick with a fork several times. Place onto Grill Tray in lower shelf position. Select program number 14. Enter the weight of the potatoes. Start to cook.
15	Chilled Pizza 	100 - 400 g 	For reheating and browning, chilled , pizza (purchased). Remove all packaging and place onto Grill Tray in upper shelf position. Select program number 15. Enter the weight of the chilled pizza. Start to cook. This program is not suitable for deep pan pizzas, stuffed crust pizzas or very thin pizzas.



Auto Cook Programs

No.	Program	Weight/ Placement	Instructions
16	Frozen Pizza 	300 - 500 g 	For reheating and browning frozen , pizza (purchased). Remove all packaging and place onto Grill Tray in upper shelf position. Select program number 16. Enter the weight of the frozen pizza. Start to cook. This program is not suitable for deep pan pizzas, stuffed crust pizzas or very thin pizzas.
17	Potato Gratin 	Base of oven	See recipe below. Place prepared potato gratin on base of oven. Select program number 17. Start to cook. Allow to stand for 5 minutes after cooking.

Gratin dauphinois

ingredients

Serves 4

700 g peeled potatoes,
1 garlic clove,
100 g emmental (grated),
salt and pepper,
150 ml single cream,
150 ml milk
50 g beaten eggs

Dish:

1 x 25 cm shallow Pyrex® dish

Accessory:

none

1. Cut the potatoes into thin slices. Peel and chop the garlic.
2. Arrange the potato slices in shallow Pyrex® dish. Scatter over the garlic, half the cheese, salt and pepper.
3. Mix the egg, milk, cream and pour the mixture over the potatoes. Cover with the rest of the grated cheese. Place on base of oven.
4. Select auto cook program 17. Start to cook. Allow to stand for 5 minutes after cooking.



Re-bake Bread Programs

1



Tap Auto Cook pad once.

2



Turn the Dial to select the food category.
(No.18-20)

3



Press the Dial to confirm the selection.

4



Select the weight by turning the Dial.
The Dial will count up in 10 g steps.

5



Press the Dial to start.
The cooking program will start and the time in
the display will count down.

When you select an automatic program, symbols will appear in the display to show the cooking mode that will be used. See below to identify the symbols:



Grill Tray









Micro Power



Grill



Re-bake Bread Programs

No.	Program	Weight/ Placement	Instructions
18	Baguette/ Crusty Rolls 	100 - 400 g 	<p>To re-bake baguettes and crusty rolls. This program is suitable for reheating, browning and crisping pre-purchased chilled baguettes and rolls. Ensure height of baguette/rolls is no more than 2 inches. Place baguette/crusty rolls onto Grill Tray in lower shelf position. Select program number 18. Enter the weight of the Baguette/Crusty Rolls. Start to cook.</p>
19	Frozen Baguette/ Frozen Crusty Rolls 	100 - 400 g 	<p>To re-bake frozen baguettes and crusty rolls. This program is suitable for reheating, browning and crisping pre-purchased frozen baguettes and rolls. Ensure height of baguette/rolls is no more than 2 inches. Place baguette/crusty rolls onto Grill Tray in lower shelf position. Select program number 19. Enter the weight of the frozen Baguette/frozen Crusty Rolls. Start to cook.</p>
20	Croissants 	50 - 350 g 	<p>To re-bake croissants. This program is suitable for reheating, browning and crisping pre-purchased, chilled croissants. Place croissants onto Grill Tray in lower shelf position. Select program number 20, Croissants. Enter the weight of the Croissants. Start to cook.</p>



Junior Menu

The Junior Menu offers a range of programs catering for babies, toddlers and older children - great for time saving and convenience. The fruit and vegetable purées are ideal first foods for weaning babies. Homemade purées taste like real food and cost less than jars or packets. Extra portions can be frozen in ice cube trays, then defrosted and reheated. Frozen Breaded Products and pasta bakes are perfect for smaller tummies. Mug cakes offer a quick and easy dessert. Simple tablespoon measurements that can be mixed in the mug for ease of preparation. Ready to eat in no time at all when using the Mug Cake program. For operation refer to page 84.

1



Tap Auto Cook pad once.

2



Turn the Dial to select the food category. (No.21-25)

3



Press the Dial to confirm the selection.

4



Select the weight by turning the Dial. The Dial will count up in 10 g steps (except for No.21&22).

5



Press the Dial to start. The cooking program will start and the time in the display will count down.

When you select an automatic program, symbols will appear in the display to show the cooking mode that will be used. See below to identify the symbols:



Grill Tray



Micro Power



Grill



Junior Menu



Junior Menu

No.	Program	Weight/ Placement	Instructions
21	Mug Cake 	1-2 Base of oven	For cooking one or two mug cakes, either Chocolate Brownie or Lemon. Prepare the mug cake as in the following recipes. Size of mug should be no smaller than 300 ml. Place it on the base of the oven. Select program number 21. Enter the serving of the mug cakes. Start to cook. Allow to stand for a few minutes after cooking. Serve warm in the mug with ice-cream, custard or cream.

Chocolate Brownie Mug Cake

ingredients

For 1 serving

5 ½ tbsp flour
 3 ½ tbsp sugar
 3 ½ tbsp cocoa powder
 3 tbsp melted butter
 3 tbsp milk
 4 squares dark or milk
 chocolate,
 chopped

Decoration: sprinkles or mini
 marshmallows

1. Mix flour, sugar and cocoa powder together in mug.
2. Add melted butter and milk and mix.
3. Add chopped chocolate. Mix thoroughly.
4. After cooking decorate with sprinkles or mini marshmallows.

Lemon Mug Cake

ingredients

For 1 serving



3 tbsp flour
 3 ½ tbsp sugar
 ½ tsp baking powder
 ⅛ tsp salt
 2 ½tbsp vegetable oil
 2 tbsp lemon juice,
 plus zest ½ lemon
 1 egg, beaten

Decoration: strawberries,
 blueberries, sprinkles

1. Mix flour, sugar, baking powder and salt together in mug.
2. Add vegetable oil, lemon juice, lemon zest and beaten egg. Mix thoroughly.
3. After cooking, decorate with strawberries, blueberries or sprinkles.





Junior Menu

No.	Program	Weight/ Placement	Instructions																
22	Junior Pasta Bake 	250/500/ 800 g 	<p>For cooking fresh pasta bake using fresh pasta (penne, spaghetti, fusilli), cheese or tomato based sauce and grated mild cheddar cheese. Use a suitable square, shallow Pyrex® container. Use the following quantities:</p> <table border="1"> <thead> <tr> <th>Servings</th> <th>250 g</th> <th>500 g</th> <th>800 g</th> </tr> </thead> <tbody> <tr> <td>Pasta</td> <td>100 g</td> <td>200 g</td> <td>300 g</td> </tr> <tr> <td>Sauce</td> <td>100 g</td> <td>250 g</td> <td>425 g</td> </tr> <tr> <td>Cheese</td> <td>50 g</td> <td>50 g</td> <td>75 g</td> </tr> </tbody> </table> <p>Other ingredients may be added such as ham, tuna and sweetcorn. In this case substitute some of the sauce for the chosen added ingredients. Place container onto Grill Tray in lower shelf position. Select program number 22. Enter the weight of the junior pasta bake. Start to cook. Stir before serving.</p>	Servings	250 g	500 g	800 g	Pasta	100 g	200 g	300 g	Sauce	100 g	250 g	425 g	Cheese	50 g	50 g	75 g
Servings	250 g	500 g	800 g																
Pasta	100 g	200 g	300 g																
Sauce	100 g	250 g	425 g																
Cheese	50 g	50 g	75 g																
23	Fruit Purée 	100 - 400 g Base of oven	<p>This program is suitable for cooking apples, pears, peaches, papaya and mango. The cooked fruit is then puréed and suitable for weaning babies. Peel and chop the fruit into even sized pieces. Place in a Pyrex® dish. Add the following quantities of water:</p> <p>100 g - 150 g fruit 50 ml water. 160 g - 300 g fruit 75 ml water. 310 g - 400 g fruit 125 ml water.</p> <p>Cover with lid. Place dish on base of oven. Select program number 23. Enter the weight of the fruit. Start to cook. Stir at beeps. After cooking allow to stand for 10 minutes. Purée the fruit with the cooking liquid using a blender. If necessary, adjust the consistency with a little water to thin or baby rice to thicken. Check the temperature before feeding.</p>																



Junior Menu

No.	Program	Weight/ Placement	Instructions
24	Vegetable Purée 	100 - 400 g Base of oven	<p>This program is suitable for cooking parsnips, potatoes, butternut squash, carrots, sweet potato and swede. The cooked vegetables are then puréed and suitable when weaning babies. Peel and chop the vegetables into even sized pieces. Place in a Pyrex® dish. Add the following quantities of water: 100 g - 150 g vegetables 75 ml water. 160 g - 300 g vegetables 100 ml water. 310 g - 400 g vegetables 150 ml water. Cover with lid. Place dish on base of oven. Select program number 24. Enter the weight of the vegetable. Start to cook. Stir at beeps. After cooking allow to stand for 10 minutes. Purée the vegetables with the cooking liquid using a blender. If necessary, adjust the consistency with a little water to thin or baby rice to thicken. Check the temperature before feeding.</p>
25	Frozen Breaded Products 	100 - 500 g 	<p>For preparing frozen breaded products such as frozen popcorn chicken, frozen chicken nuggets, frozen turkey drummers, frozen fish fingers, frozen scampi. Remove all packaging and place the frozen breaded products onto the Grill Tray in upper shelf position. Select program number 25. Enter the weight of the frozen breaded products. Start to cook.</p>

** Chaos Defrost

This feature allows you to defrost minced meat, chops, chicken portions, meat joints and bread. Tap Chaos Defrost pad to select the correct defrost category and then enter in the weight of the food in grams (see page 88).

Foods should be placed in a suitable dish, whole chickens and joints of meat should be on an upturned saucer or on a microwave safe plate. Chops, chicken portions and slices of bread should be placed in a single layer. It is not necessary to cover the foods.

The **Chaos theory** principle is used in auto weight defrost programs to give you a quick and more even defrost. The **Chaos** system uses a random sequence of pulsing microwave energy which speeds up the defrosting process. During the program the oven will beep to remind you to check the food. **It is essential that you turn and stir the food frequently and shield if necessary. On hearing the first beep you should turn and shield (if possible). On the second beep you should turn the food or break it up.**

1st Beep

Turn



1st Beep

Or shield



2nd Beep

Turn or break up



Note

1. Check foods during defrosting. Foods vary in their defrosting speed.
2. It is not necessary to cover the food.
3. Always turn or stir the food especially when the oven “beeps”. Shield if necessary (see point 5).
4. Minced meat/chops/chicken portions should be broken up or separated as soon as possible and placed in a single layer.
5. Shielding prevents food cooking. It is essential when defrosting chickens and joints of meat. The outside thaws out first, so protect wings/breast/fat with smooth pieces of aluminium foil secured with cocktail sticks.
6. Allow standing time so that the centre of the food thaws out (minimum 1-2 hours for joints of meat and whole chickens).
7. If ‘HOT’ appears in the display window, the oven temperature is too high from previous use and an auto program can not be set. Cooking mode and time may still be set manually.

** Chaos Defrost

With this feature you can defrost frozen foods according to the weight. Select the category and set the weight of the food. The weight is programmed in grams. For quick selection, the weight starts from the minimum weight for each category.

1



Tap Chaos Defrost pad once.

2



Turn the Dial to select the food category.
(No.26-28)

3



Press the Dial to confirm the selection.

4



Select the weight by turning the Dial.
The Dial will count up in 10 g steps.



5



Press the Dial to start.

No.	Program	Weight/ Placement	Instructions
26	Meat Items 	100 - 1200 g Base of oven	To defrost small pieces of meat, chicken portions, chops, steaks, minced meat. Place on a plate or shallow Pyrex® dish. Select program number 26. Enter the weight of the meat items. Start to defrost. Turn at beeps and shield.
27	Meat Joints 	400 - 2000 g Base of oven	To defrost whole chicken, meat joints. Select program number 27. Enter the weight of the meat joints. Start to defrost. Turn at beeps and shield.

****** Chaos Defrost

No.	Program	Weight/ Placement	Instructions
28	Bread  **  	100 - 900 g Base of oven	To defrost rolls, buns, slices of bread and loaves. Place on a plate. Select program number 28. Enter the weight of the bread. Start to defrost. Turn and re-arrange at beeps.

1. Meat items (mince/chops/chicken portions)

Chops and chicken portions should be arranged in a single layer and turned frequently during defrosting. It is necessary for mince to be broken up frequently during defrosting and this is best carried out in a large shallow dish. Standing time 20-30 mins. **Not suitable for sausages, these can be defrosted manually.** Please refer to defrosting chart on pages 45-46.

2. Meat joints/Whole chickens

Whole chickens and meat joints will require shielding during defrosting especially if it is a particularly fatty piece. This is to prevent food starting to cook on the outside edges. Protect wings, breast and fat with smooth pieces of aluminium foil secured with cocktail sticks. **Do not allow the foil to touch the walls of the oven.** Standing time of at least 1-2 hours should be allowed for joints after defrosting.

3. Bread

This program is suitable for small items which are required for immediate use, they may feel warm straight after defrosting. Loaves can also be defrosted on this program but these will require standing time to allow the centre to thaw out. Standing time can be shortened if slices are separated and buns and loaves cut in half. Items should be turned during defrosting. Standing time 10 - 30 minutes. A longer time may be needed for large loaves. **This program is not suitable for cream cakes or desserts** e.g. cheesecake.



Note

1. The shape and size of the food will determine the maximum weight the oven can accommodate.
2. Allow standing time to ensure the food is completely defrosted.
3. If 'HOT' appears in the display window, the oven temperature is too high from previous use and an auto program can not be set. Cooking mode and time may still be set manually.

Cleaning Setting

F1. Drain Water

Water is pumped through the system to clean the pipes. The water is drained into the drip tray.

1

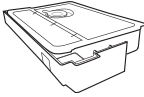

Add 100 g of water to the water tank.
Ensure drip tray is empty.

2



Tap Cleaning pad once.

3



Turn the Dial to select F1. Drain Water.

4



Press the Dial to confirm the selection.

5



Press the Dial to start.



Note

1. Only run this program with 100 g of water in the tank.
2. Do not remove the drip tray during the drain water program.
3. Empty the drip tray and rinse with running water after the program has finished.



Caution!

If the drain water program is used directly after a steam cooking program, hot water may be drained into the drip tray.

Cleaning Setting

F2. System Cleaning

The first stage of this program cleans the system with a citric acid solution. The second stage runs water through the system to rinse the pipes.

1

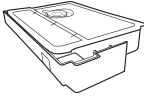

Make a solution of 16 g citric acid and 200 g of water, add the solution to the water tank. Ensure drip tray is empty.

2



Tap Cleaning pad once.

3



Turn the Dial to select F2. System Cleaning.

4



Press the Dial to confirm the selection.

5



Press the Dial to start.
The program will run for approx. 29 minutes.

6

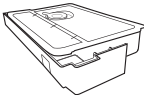

After the program has paused, empty the drip tray and fill the water tank with water (to max level).

7



Press the Dial to start.
The program will run for approx. 1 minute.
Empty the drip tray after the program has finished.

Cleaning Setting

F2. System Cleaning



Note

1. When "  " icon is displayed, run the 'system cleaning' program.
2. If the system cleaning program is not used regularly, the pipe will get blocked and the steaming performance will be less effective.
3. Do not remove the drip tray during the system cleaning program.
4. Empty the drip tray and rinse with running tap water after the program has finished.

F3. Deodorization

This feature is recommended for eliminating any odours from the oven.

1



Tap Cleaning pad once.

2



Turn the Dial to select F3. Deodorization.

3



Press the Dial to confirm the selection.

4



Press the Dial to start.

The program time appears in the display window and begins to count down. The program will run for 20 minutes.

Cleaning Setting

F4. Cavity Cleaning

This feature is suitable for removing the build up of fat or grease in the cavity.

1



Tap Cleaning pad once.

2



Turn the Dial to select F4. Cavity Cleaning.

3



Press the Dial to confirm the selection.

4



Press the Dial to start.

The program time appears in the display window and begins to count down. The program will run for 20 minutes.



Note

1. Fill the tank with water before using.
2. After cleaning, open the door and wipe with a damp cloth and empty the drip tray.

Cleaning the Water Tank

Clean with a soft sponge in water.

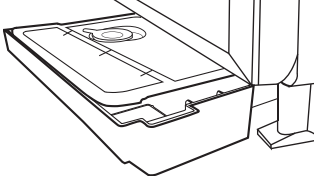

Remove the water tank and clean the compartment where the water tank is inserted.

Open the water supply cap, remove the lid and pipe cap and clean.

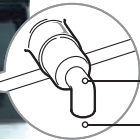

Pipe Cap

Ensure it faces downwards

If the pipe cap is difficult to remove, wiggle from side to side. When re-fitting, make sure that the pipe faces down (see diagram).



Note

1. There is a spring at the insertion port of the pipe, please store it properly when cleaning, and do not lose it.
2. Clean the water tank at least once a week to prevent build up of limescale.
3. Do not use a dishwasher to clean the water tank or parts of the water tank.

Cooking and Reheating Guidelines

Most foods reheat very quickly in your oven by HIGH power. Meals can be brought back to serving temperature in just minutes and will taste freshly cooked. Always check food is piping hot and return to oven if necessary.

As a general rule, always cover wet foods, e.g. soups, casseroles and plated meals.

Do not cover dry foods e.g. bread rolls, mince pies, sausage rolls etc.

The charts on pages 97-112 show you the best way to cook or reheat your favourite foods. The best method depends on the type of food you are cooking or reheating.

Remember to stir or turn food wherever possible during cooking or reheating. This ensures even cooking or reheating on the outside and in the centre.

When is food reheated?

Food that has been reheated or cooked should be served “piping hot” i.e. steam should be visibly emitted from all parts. As long as good hygiene practices have been followed during the preparation and storage of the food, then cooking or reheating presents no safety risks. Foods that cannot be stirred should be cut with a knife to test that they are adequately heated throughout. Even if a manufacturer’s instructions or the times in the chart have been followed, it is still important to check the food is heated thoroughly. If in doubt, always return to the oven for further reheating.

If you cannot find the equivalent food in the chart then choose a similar type and size listed and adjust the cooking time if necessary.

Plated meals

Everyone’s appetite varies and reheat times depend on meal contents. Dense items e.g. mashed potato, should be spread out well. If a lot of gravy is added, extra time may be required. Place denser items to the outside of the plate. An average plated meal will take 4-7 minutes on HIGH power to reheat. Do not stack meals.

Canned foods

Remove foods from can and place in a suitable dish before heating. Stir food halfway through cooking and again at the end of heating.

Soups

Use a bowl and stir before heating and at least once during reheating and again at the end.

Casseroles

Stir halfway through and again at the end of heating.

Cooking and Reheating Guidelines



Caution - Mince pies

Remember even if the pastry is cold to the touch, the filling will be piping hot and will warm the pastry through. Take care not to overheat otherwise burning can occur due to the high fat and sugar content of the filling. Check the temperature of the filling before consuming to avoid burning your mouth.



Caution - Christmas puddings and liquids

Take great care when reheating these items.
Do not leave unattended.
Do not add extra alcohol.



Caution - Babies' bottles

Milk or formula must be shaken thoroughly before heating and again at the end and tested carefully before feeding a baby. Liquid at the top of the bottle will be much hotter than at the bottom. The bottle must be shaken thoroughly and tested before use.



Note

We do not recommend that you use your microwave to sterilise babies' bottles. If you have a special microwave steriliser we urge extreme caution, due to the low quantity of water involved. It is vital to follow the manufacturers' instructions implicitly.

Reheating Charts

The times given in the charts below are a guideline only, and will vary depending on STARTING temperature, dish size and quantity. Pastry or bread items reheated by microwave will be soft not crisp.

Heating category

Your oven is Heating Category E and this is displayed on the rear of your oven. The information on this label will assist you in using new instructions on food packs to enable you to program the best heating time in your oven.

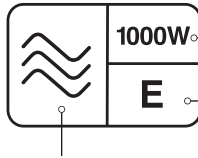

Microwave symbol

The IEC (60705) power output (watts)

The heating category for small packs of food

Points for checking

Always check that food is piping hot after reheating in the microwave. If unsure return to oven. Foods will still require a standing time, especially if they cannot be stirred. The denser the food the longer the standing time.

Food	Weight/Quantity	Power Level	Time to Select (approx)	Instructions/Guidelines
Babies bottles – CAUTION				
After heating by Microwave, liquid at the top of a bottle will be much hotter than at the bottom of the bottle and must be shaken thoroughly before checking the temperature. When testing the temperature of the milk, squirt a little onto your inner wrist. The milk droplets on your skin should feel warm, not hot.				
For 250 ml of milk from fridge temperature, remove top and teat. Heat on HIGH Power for 40 secs. CHECK CAREFULLY.				
For 100 ml of milk from fridge temperature, remove top and teat. Heat on HIGH Power for 20 secs. CHECK CAREFULLY.				
Bread – Precooked – Fresh – N.B. Breads reheated by Microwave will have a soft base.				
Croissants/ Brioche	1	High Micro	10 secs	Place in Pyrex® dish on base. Do not cover.
	4	High Micro	30 secs	
	any	Combi 1	2 min 30 secs - 3 min 30 secs	Place on Grill Tray in lower shelf position.

Reheating Charts

Food	Weight/ Quantity	Power Level	Time to Select (approx)	Instructions/ Guidelines
Canned pasta				
Ravioli/ Macaroni cheese/ Spaghetti	400 g	High Micro	2 mins 30 secs	Place in a heatproof bowl and cover. Place on base and stir halfway.
Canned soups				
Condensed	295 g	High Micro	3-4 mins	Place in a heatproof bowl and stir in one can of water. Cover and place on base stirring halfway.
Vegetable/ Broth/ Creamed	400/415 g	High Micro	3 mins	Place in a heatproof bowl and cover. Place on base and stir halfway.
Chilled soups				
1 portion	250 ml	High Micro	2 mins- 2 mins 30 secs	Place in a heatproof bowl and cover. Place on base and stir halfway.
2 portion	500 ml		4 mins-4 mins 30 secs	
Canned vegetables				
Baked beans/ Butter Beans	200 g	High Micro	1 min 30 secs	Place in a heatproof bowl and cover. Place on base and stir halfway.
	415 g		2 mins-2 mins 30 secs	
Carrots	300 g		4 mins	
Mushroom/ Peas/ Tomatoes/ Sweet Corns	300 g		2 mins-2 mins 30 secs	
Plated meal - chilled				
Small - child portion	1	High Micro	4-5 mins	Cover and place on base.
Large - adult portion			7 mins	

Reheating Charts

Food	Weight/ Quantity	Power Level	Time to Select (approx)	Instructions/ Guidelines
Drinks				
1 Mug cold milk	235 ml	High Micro	1 min 30 secs	Place in a heatproof container on base. Stir halfway and after reheating.
1 Jug cold milk	568 ml (1 pint)		4 mins	
1 Mug cold coffee/tea	235 ml		1 min 20 secs	
1 Mug cold milky coffee			1 min 20 secs	
Baby food	70 g	Medium Micro	10-20 secs	
	125 g		20-30 secs	
	190 g		30-40 secs	
Savoury pastry products - precooked.				
Pastries reheated by microwave will have a soft base				
Pasties/ Slices	150 g	High Micro	1 min 30 secs	Place on a plate on base.
	150 g 300 g (2)	Combi 1	7-9 mins 10-11 mins	Place on Grill Tray in lower shelf position.
Meat pies	150 g	High Micro	1 min 30 secs- 2 mins	Place on a plate on base.
	150 g	Combi 2	6-7 mins	Remove product from foil container and place on Grill Tray in lower shelf position.
	300 g (2)		7-8 mins	
	250 g	Combi 2	7-8 mins	
550 g	15 mins			
Quiche	150 g	Combi 2	7-8 mins	Remove product from foil container and place on Grill Tray in lower shelf position.
	400 g		10-11 mins	
Sausage roll x 1	150 g	High Micro	1 min 10 secs	Place in Pyrex® dish on base of oven.
		Combi 1	6-8 mins	Place on Grill Tray in lower shelf position.
Sausage roll Snack size x 5	300 g	Combi 1	5-7 mins	
Pretzels	300 g	180 °C	13-15 mins	

Reheating Charts

Food	Weight/ Quantity	Power Level	Time to Select (approx)	Instructions/ Guidelines
Pretzels (frozen)	300 g	160 °C	15-17 mins	Place on Grill Tray in lower shelf position.
Pains au chocolat (Precooked)	360 g	180 °C	12-14 mins	
Mini crossiants (frozen)	200-300 g	150 °C	16-17 mins	
Puddings and desserts - where microwave only is involved transfer food from foil container to a similar sized heatproof dish.				
Chilled custard	500 g	High Micro	3 mins	Place in large jug. Cover and place on base and stir halfway.
Chilled rice pudding	180 g	High Micro	1 min	Place on base.
	500 g		2 mins	Place in a heatproof dish. Cover and place on base. Stir halfway.
Chilled Fruit crumble	550 g	Combi 1	12 mins	Place in a heatproof dish on base.
Sponge pudding	110 g x 1	Combi 3	2 mins	Pierce film lid and place on base.
	220 g x 2		3 mins 30 secs	
Christmas pudding - Do not leave unattended as overheating can cause the food to ignite.				
Small	100 g	Combi 4	1 min	Pierce film lid and place on plate on base.
Medium	227 g		2 mins	
Large	454 g		5 mins	
Ready meals - chilled. Transfer food from foil container to a similar sized heatproof dish. Healthy eating options will only slightly brown on combination because of the lower fat content.				
Cauliflower cheese	400 g	Combi 1	7 mins	Place in heatproof dish on base.
Cottage/ shepherds pie	450 g	High Micro	4 mins	Place on base.
		Combi 1	10 mins	
	800 g	Combi 1	15 mins	

Reheating Charts

Food	Weight/ Quantity	Power Level	Time to Select (approx)	Instructions/ Guidelines
Fish/veg bake	450 g	High Micro	5 mins	Place on base.
		Combi 1	12 mins	
	900 g	Combi 1	17 mins	
Onion bhajis/ samosas	200 g	Combi 1	5 mins	Place on Grill Tray in upper shelf position. Turn halfway.
Lasagne	450 g	High Micro	6 mins	Place on base.
		Combi 1	8 mins	
	800 g	Combi 1	16 mins	
Macaroni cheese	450 g	Combi 1	10 mins	Place on base.
Chilled mashed potato	500 g	High Micro	4-5 mins	Pierce lid and place on base. Stir halfway.
Rice (with 30 ml cold water)	200 g	High Micro	1 min 30 secs - 2 mins	Place in a heat proof dish and cover on base of oven. Stir halfway.
	500 g		3 min 30 secs - 4 mins	
Ready meals - frozen. Transfer food from foil container to a similar sized heatproof dish.				
Cauliflower cheese	400 g	Combi 2	25 mins	Place on base.
Cottage/fish/ shepherds pie	400 g	High Micro	12 mins	
		Combi 2	25 mins	
Lasagne/ cannelloni	400 g	High Micro	10 mins	
		Combi 2	20 mins	
Macaroni cheese	400 g	High Micro	10-12 mins	
		Combi 2	18 mins	
Sausage roll	160 g (1)	Combi 1	8-9 mins	Place on Grill Tray in lower shelf position.
	260 g (6)		11-13 mins	
Quiche	400 g (1)	Combi 2	14-16 mins	Place on Grill Tray in lower shelf position. Allow to stand for 5 minutes.

Reheating Charts

Food	Weight/ Quantity	Power Level	Time to Select (approx)	Instructions/ Guidelines
Sauce				
Sauces	250 g	High Micro	2 mins-2 mins 30 secs	Place in a heatproof dish. Cover and place on base. Stir halfway.
	500 g		4-5 mins	
Quorn®				
Burgers	180 g (2)	Combi 5	10 mins	Place on Grill Tray in upper shelf position. Turn halfway.
Escalopes	240 g (2)	Combi 1	4-6 mins	Place on Grill Tray in upper shelf position.
Desserts				
Brownies (frozen)	120 g (2)	Combi 1	3-4 mins	Place on Grill Tray in upper shelf position.
Sweet pancakes	70 g (1)	High Micro	20-30 secs	Place in a heatproof dish on base of oven.
	140 g (2)		40-50 secs	
Sweet pancakes (frozen)	70 g (1)		40-50 secs	
	140 g (2)		1 min-1 min 20 secs	
Donuts plain (frozen)	50 g (1)	Combi 1	2-3 mins	Place on Grill Tray in lower shelf position. Turn halfway. Allow 2 minutes standing time.
	100 g (2)		3-4 mins	
Apple crumble (frozen)	600 g	Combi 1	12-13 mins	Place in a heat proof dish on base of oven.
Chocolate cake with molten centre	130 g (1)	Combi 4	1 min 30 secs - 2 mins	Place on the base of oven. Pierce film lid.
Chocolate cake with molten centre (frozen)	130 g (1)		3 mins-3 mins 30 secs	
	220 g (1)		3-4 mins	
Apple strudel (precooked)	460 g (1)	200 °C	18-20 mins	Preheat oven. Place on Grill Tray in lower shelf position.

Cooking Charts

Points for checking

Always check that food is piping hot after reheating in the microwave. If unsure return to oven. Foods will still require a standing time, especially if they cannot be stirred. The denser the food the longer the standing time. Fill water tank before use.

Food	Weight/ Quantity	Power Level	Time to Select (approx)	Instructions/ Guidelines
Bread				
Part baked bread rolls	300 g (6)	Combi 2	8-10 mins	Place on Grill Tray in lower shelf position.
Bacon and pork - from raw - Caution: Hot fat! Remove accessories with care.				
Bacon rashers	300 g (8)	Grill 1	8 mins	Place on Grill Tray in upper shelf position.
Pork joint	-	220 °C Followed By 190 °C	for 30 mins then 60 mins per 500 g Max weight 1.5 kg	Preheat oven. Place joint on Grill Tray in lower shelf position. Leave for 10 mins after cooking and before carving.
Pork loin steaks	500 g (5)	Grill 1	18-20 mins	Place on Grill Tray in upper shelf position. Turn halfway.
Beans and pulses - should be pre-soaked in cold water overnight (boiling water split yellow peas) except lentils which do not need to be pre-soaked				
Peas (Black eyed peas, Chick peas, Split yellow peas)	250 g	High Micro Then Simmer Micro	10 mins then 40 mins	Use 600 ml (1 pt) boiling water in a large bowl. Cover. Place on base.
Lentils	250 g	High Micro	12 mins	Use 600 ml (1 pt) boiling water in a large bowl. Cover. Place on base.

Cooking Charts

Food	Weight/ Quantity	Power Level	Time to Select (approx)	Instructions/ Guidelines
Beef - Caution: Hot fat! Remove dish with care. Recommended temperatures for beef are: Rare 60 °C; medium 70 °C; well done 80 °C.				
Beef burgers (fresh)	227 g (2)	Grill 1	12-14 mins	Place on Grill Tray in upper shelf position. Turn halfway.
Joint	-	220 °C	20 mins per 450 g/1 lb Rare: 20 mins Medium: 30 mins Well done: 40-50 mins	Preheat oven. Place on Grill Tray in lower shelf position. Turn halfway.
Rump/sirloin	250 g	Grill 1	Medium: 14 mins Well done: 18 mins	Place on Grill Tray in upper shelf position. Turn halfway.
Stewing steak	450-675 g	160 °C	1 hour-1 hour 30 mins	Place in casserole dish with lid. Add stock and vegetables. Cover, place Grill Tray in lower shelf position. Stir halfway.
Chicken from raw - Caution: Hot fat! Remove accessory with care.				
Whole	-	190 °C	30 mins per 450 g	Preheat the oven. Place chicken on Grill Tray in lower shelf position.

Cooking Charts

Food	Weight/ Quantity	Power Level	Time to Select (approx)	Instructions/ Guidelines
Eggs - Poached.				
1 Egg	45 ml water	High Micro Then Medium Micro	1 min 10 secs then 1 min	<ol style="list-style-type: none"> 1. Place water in a shallow dish and heat for 1st cooking time on base of the oven. 2. Add egg (size 3). 3. Pierce yolk and white. 4. Cover with pierced cling film. 5. Cook for 2nd cooking time. 6. Then leave to stand for 1 min.
Eggs - Scrambled. Use microwave safe bowl.				
1 Egg	-	High Micro	30 secs then 30 secs	<ol style="list-style-type: none"> 1. Add 1 tbsp of milk for each egg used. 2. Beat eggs, milk and knob of butter together. 3. Place bowl on base. 4. Cook for 1st cooking time then stir. 5. Cook for 2nd cooking time stirring halfway then stand for 1 min.
Fish - fresh from raw.				
Breaded Fillets	350 g (2)	Combi 2	12-14 mins	Place on Grill Tray in lower shelf position.
Fillets	300 g	Medium Micro	7 mins	Place in Pyrex [®] dish. Add 1 tbsp (15 ml) water. Cover and place on base of oven.
	700 g		9 mins	

Cooking Charts

Food	Weight/ Quantity	Power Level	Time to Select (approx)	Instructions/ Guidelines
Steaks	300 g (2)	Combi 5	13-15 mins	Place on Grill Tray in lower shelf position.
Whole x 1	225 g/ 300 g	High Micro	4 mins	Place in Pyrex® dish and pierce skin. Add 30 ml of liquid. Cover and place on base of oven.
Fish-Frozen from raw.				
Breaded fillets	200 g (2)	Combi 2	10-12 mins	Place on Grill Tray in lower shelf position. Turn halfway.
Fillets	300 g	Steam 1		
Fruit - Peel, slice, chop into even sized pieces. Place in shallow heatproof dish on base of oven.				
Fruit - stewed	500 g	Combi 4	10 mins	Place on base of oven.
Fruit - poached	400 g	High Micro	6-8 mins	Add 300 ml (½ pt) of water. Only half fill dish. Cover.
Game- Caution: Hot fat! Remove accessory with care.				
Duck breast fillets	400 g	200 °C	40 mins	Preheat oven. Prick the skin and place on Grill Tray in lower shelf position.
Duck, whole	-	190 °C	25-27 mins per 450 g	
Pheasant, whole	-	180 °C	20-25 mins per 450 g plus 20 mins	Preheat oven. Place on Grill Tray in lower shelf position.
Lamb - from raw - Caution: Hot Fat! Remove accessory with care.				
Joint	Joint Maximum weight 1.5 kg	180 °C	Medium: 20 mins per 450 g plus 20 minutes or Well done: 30 mins per 450 g plus 25 minutes.	Preheat oven. Place joint on Grill Tray in lower shelf position. Once cooked allow the joint to stand for 10 minutes - this will make the joint easier to carve.

Cooking Charts

Food	Weight/ Quantity	Power Level	Time to Select (approx)	Instructions/ Guidelines
Loin/ leg steaks	600 g (4)	Grill 1	Medium: 18-19 mins Well done: 21-24 mins	Place on Grill Tray in upper shelf position. Turn halfway.
Chops/ cutlets	400 g (4)	Grill 1	Medium: 13-14 mins Well done: 15-17 mins	
Casserole/ stewing Lamb	Maximum weight 1.5 kg	160 °C	1hr 20 mins - 1hr 30 mins	Preheat oven. Place in casserole, add stock and vegetables, cover and place on Grill Tray in lower shelf position. Stir halfway.
Pasta. Use 3 litre (6 pt) large bowl				
Fusilli/ macaroni/ penne	200 g	High Micro	10 mins	Use 550 ml (1 pint) boiling water. Add 15 ml oil. Cover. Stir halfway.
Linguine/ tagliatelle	250 g		12 mins	Use 700 ml (1¼ pt) boiling water. Add 15 ml oil. Cover. Stir halfway.
Spaghetti	250 g		8-10 mins	
Porridge - N.B. Use a large bowl.				
1 serving	30 g oats 150 ml (¼ pt) milk	High Micro	2 mins	Place on base and stir halfway.
2 servings	50 g oats 275 ml (½ pt) milk		3 mins 30 secs	
4 servings	100 g oats 550 ml (1 pt) milk		5 mins	

Cooking Charts

Food	Weight/ Quantity	Power Level	Time to Select (approx)	Instructions/ Guidelines
Turkey				
Breasts, boneless and skinless	350 g	Steam 1	30 mins	Place on Grill Tray in upper shelf position.
Crown, off the bone	Maximum weight 1.5 kg	190 °C	30-35 mins. per 450 g	Preheat oven. Place on Grill Tray in lower shelf position.
Steam cooking for fresh vegetables				
Asparagus/ Brussel sprouts	200 g	Steam 1	10-11 mins	Steam only: Place on Grill Tray in upper shelf position. Combi 4: Place in shallow Pyrex dish on base of oven.
		Combi 4	6 mins	
Baby corn/ peas, spinach	200 g	Steam 1	10 mins	
		Combi 4	5 mins	
Beans	200 g	Steam 1	12 mins	
		Combi 4	8 mins	
Beetroot	450 g	Steam 1	28 mins	
		Combi 4	15 mins	
Broccoli	250 g	Steam 1	12 mins	
		Combi 4	8 mins	
Butternut squash/ Cabbage- sliced, Turnip	300 g	Steam 1	22 mins	
		Combi 4	12 mins	
Parsnips	300 g	Steam 1	12 mins	
		Combi 4	7 mins	
Potatoes - boiled	500 g	Steam 1	28 mins	
		Combi 4	15 mins	
Potatoes - par-boiled	500 g	Steam 1	20 mins	
		Combi 4	12 mins	
Swede - cubed, Sweet Potato	400 g	Steam 1	21-22 mins	
		Combi 4	12 mins	
Jacket potatoes	x 1	Combi 4	14 mins	
	x 2		17 mins	

Cooking Charts

Food	Weight/ Quantity	Power Level	Time to Select (approx)	Instructions/ Guidelines
Frozen vegetables				
Beans, Sweet Corns, Mixed vegetables	200 g	Combi 4	8 mins	Place in Pyrex® dish on base of oven.
Broccoli - florets	250 g		8 mins	
Carrots - sliced	200 g		7 mins	
Cauliflower	250 g		10 mins	
Peas	200 g		7 mins	
Steam only				
Fresh Fish	200 g	Steam 1	9-11 mins	Place on Grill Tray in upper shelf position. Place fish in a single layer. Do not overlap.
	500 g		14-16 mins	
Frozen fish	200 g		14-16 mins	
	500 g		19-21 mins	
Chicken breast	200 g		27-30 mins	Each breast should weigh between 100- 250 g each. Place on Grill Tray in upper shelf position.
Light dishes and snacks				
Croque- monsieur	150 g (1)	Combi 1	5-6 mins	Place on Grill Tray in lower shelf position. Turn when golden.
	300 g (2)		6-8 mins	
Croque- monsieur (Frozen)	150 g (1)		8-10 mins	
Hot dog	140 g (1)		6-7 mins	Place on Grill Tray in lower shelf position.
Hot Pocket (Frozen)	115 g (2)		6-8 mins	Place on Grill Tray in lower shelf position. Allow to stand for 2 mins.

Cooking Charts

Food	Weight/ Quantity	Power Level	Time to Select (approx)	Instructions/ Guidelines
Light dishes and snacks				
Ham and cheese pasty	150 g (1)	Combi 1	5-7 mins	Place on Grill Tray in lower shelf position.
Ham and cheese pasty (Frozen)	150 g (1)	Combi 2	10-12 mins	Place on Grill Tray in lower shelf position. Allow to stand for 2 mins.
Mini puff pastry snacks (for cooking) (Frozen)	325 g (20)	190 °C	25-27 mins	Spread out on Grill Tray in lower shelf position.
Tartlets (Frozen)	290 g (20)	Combi 2	6-8 mins	Place on Grill Tray in lower shelf position.
Mini filo pastry snacks (Frozen)	180 g (12)	190 °C	16-17 mins	Place on Grill Tray in lower shelf position.
Quiche (bacon, cream and onion flan)	170 g (1)	Combi 2	8-9 mins	Place on Grill Tray in lower shelf position. Allow to stand for 2 mins.
	330 g (1)		12-13 mins	
Quiche (bacon, cream and onion flan) (frozen)	170 g (1)		14-15 mins	
	330 g (1)		15-18 mins	
Focaccia	300 g (1)	Combi 5	7-8 mins	Place on Grill Tray in lower shelf position.
Focaccia (Frozen)	300 g (1)	Combi 2 then Combi 5	5-7 mins then 8-9 mins	
Gratins (dauphine potatoes, moussaka, lasagnes, tartiflette, shepard's pie, macaroni)	350 g	Combi 2	9-10 mins	Place in heatproof dish on base of oven.
	800 g	Combi 1	12-13 mins	
	1000 g		14-15 mins then 5 mins	
	1300 g		16-17 mins then 5 mins	

Cooking Charts

Food	Weight/Quantity	Power Level	Time to Select (approx)	Instructions/Guidelines
Stuffed mushrooms	400 g (4)	Combi 2	13-15 mins	Place on Grill Tray in lower shelf position.
Oven chips, potato wedges, potato rostis, roast potatoes and other potato dishes	300 g	220 °C	13-15 mins	Preheat oven. Place on Grill Tray in upper shelf position. Turn halfway.

Low-Oil Oven Fry Charts

Food	Weight/Quantity	Power Level	Time to Select (approx)	Instructions/Guidelines
Frozen				
Thin frozen fries	300 g	Oven (Preheat at 220 °C)	23-25 mins	Place on Grill Tray in upper shelf position, stir at $\frac{2}{3}$ of total time.
Thick frozen fries/Frozen potato steak fries/wedges	300 g		40-45 mins	
Frozen cheese sticks	400 g		16-18 mins	Place on Grill Tray in upper shelf position, turn at $\frac{2}{3}$ of total time.
Frozen chicken nuggets	400 g		25-30 mins	
Frozen fish fingers	350 g		20-23 mins	
Fresh				
Homemade fries	500 g	Oven (Preheat at 220 °C)	30-35 mins	Place on Grill Tray in upper shelf position. soak in cold water for 1-3 hour in the refrigerator, dry and mix with oil, stir at $\frac{2}{3}$ of total time.

Low-Oil Oven Fry Charts

Food	Weight/ Quantity	Power Level	Time to Select (approx)	Instructions/ Guidelines
Steak (½ inch of thickness)	4 pcs (670 g)	Oven (Preheat at 220 °C)	12-14 mins	Seasoned. Place on Grill Tray in upper shelf position, turn over at ⅔ of total time.
Pork chops	4 pcs (450 g)		20-24 mins	
Hamburger	4 pcs (560 g)		16-20 mins	
Chicken wings	1000 g		25-30 mins	
Drumsticks	6 pcs (800 g)		35-40 mins	
Chicken breast	4 pcs (800 g)		30-35 mins	
Fish fillets	4 pcs (450 g)		20-25 mins	Seasoned. Place on Grill Tray in upper shelf position, less than 1½ inch of thickness.
Sweet potato	350 g	21-24 mins	Seasoned. Place on Grill Tray in upper shelf position, stir at ⅔ of total time.	
Tofu	800 g	18-22 mins	Cut into large Pieces, Seasoned. Place on Grill Tray in upper shelf position.	

Questions and Answers

Q: Why won't my oven turn on?

A: When the oven does not turn on, check the following:

1. Is the oven plugged in securely? Remove the plug from the outlet, wait 10 seconds and reinsert.
2. Check the circuit breaker and the fuse. Reset the circuit breaker or replace the fuse if it is tripped or blown.
3. If the circuit breaker or fuse is all right, plug another appliance into the outlet. If the other appliance works, there probably is a problem with the oven. If the other appliance does not work, there probably is a problem with the outlet. If it seems that there is a problem with the oven, contact an authorised Service Centre.

Q: My oven causes interference with my TV. Is this normal?

A: Some radio, TV, Wi-Fi, cordless telephone, baby monitor, blue tooth or other wireless equipment interference might occur when you cook with the microwave oven. This interference is similar to the interference caused by small appliances such as mixers, vacuums, blow dryers, etc. It does not indicate a problem with your oven.

Q: The oven won't accept my program. Why?

A: The oven is designed not to accept an incorrect program. For example, the oven will not accept a fourth stage.

Q: Sometimes warm air comes from the oven vents. Why?

A: The heat given off from the cooking food warms the air in the oven cavity. This warmed air is carried out of the oven by the air flow pattern in the oven. There are no microwaves in the air. The oven vents should never be blocked during cooking.

Q: I can't set an auto cook program and 'HOT' appears in the display. Why?

A: If 'HOT' appears in the display window, the oven temperature is too high from previous use and an auto program can not be set. Cooking mode and time may still be set manually.

Q: Can I use a conventional oven thermometer in the oven?

A: Only when you are using grill/oven cooking modes. The metal in some thermometers may cause arcing in your oven and should not be used on microwave and combination with Microwave cooking modes.

Questions and Answers

Q: There are humming and clicking noises from my oven when I cook by combination. What is causing these noises?

A: The noises occur as the oven automatically switches from microwave power to grill/oven to create the combination setting. This is normal.

Q: My oven has an odour and generates smoke when using the combination, oven and grill function. Why?

A: After repeated use, it is recommended to clean the oven and then run F3 Deodorization.

Q: The oven stops cooking by microwave and "H97", "H98" or "H00" appears in the display. Why?

A: This display indicates a problem with the microwave generation system. Please contact an authorised Service Centre.

Q: The fan continues to rotate after cooking. Why?

A: After using the oven, the fan motor may rotate to cool the electrical components. This is normal and you can continue using the oven at this time.

Q: Can I check the pre-set oven temperature while cooking by oven?

A: Yes. Tap **Oven** pad and the oven temperature will appear in the display window for 2 seconds.

Q: "DEMO MODE PRESS ANY KEY" appears in the display and the oven does not cook. Why?

A: The oven has been programmed in demo mode. This mode is designed for retail store display. Deactivate this mode by tap **Micro Power** once and **Stop/Cancel** 4 times.

Q: The operation guide has disappeared on my display, I can only see numbers. Why?

A: The operation guide was turned off by tapping **Timer/Clock** 4 times. When colon or time of day is displayed, tap **Timer/Clock** 4 times to turn the operation guide back on.

Q: The oven stops cooking by steam or combination with steam and U14 appears in the display.

A: The water tank is empty and the operation guide has been turned off. Re-fill the water tank, position back in the oven and press the **Dial** to resume cooking. If this happens 3 times during operation, cooking will stop. Press **Stop/Cancel** to reset.

Q: The control panel keys do not respond when tapped. Why?

A: Ensure the oven is plugged in.



Steamed Provencal Fish Fillets

Ingredients

Servings 4

1 courgette, sliced

4 tomatoes, sliced

10 ml mixed herbs

4 salmon fillets

30 ml olive oil

12 black olives, stoned

salt and pepper

Accessory

 Grill Tray

 Fill Water Tank

Time & Setting

approx. 20-23 minutes

Combi 3 (Steam + Microwave)

Method

1. Place the courgette in a single layer on the Grill Tray, top with tomatoes. Sprinkle with some mixed herbs. Place the salmon fillets on top of the vegetables and sprinkle with some more herbs. Drizzle over olive oil.
2. Place the Grill Tray in the lower shelf position and cook on **Combi 3** for 18-20 minutes. Add olives and continue to cook for 2-3 minutes.



Spiced Sweet Potato Fries

Ingredients

- 2 big sweet potatoes
- 2 tbsp olive oil
- 1 tsp cinnamon
- 1 tsp smoked paprika
- ½ tsp cumin
- ½ tsp ground coriander
- pink himalayan salt

Accessory

-  Grill Tray

Time & Setting

- approx. 17-20 minutes
- Combi 2** (Grill + Microwave)

Method



1. Cut sweet potatoes in half lengthwise, then cut into wedges.
2. Season sweet potatoes with olive oil, spices and salt, then arrange them on the Grill Tray.
3. Cook them on **Combi 2** in upper shelf position for 17-20 minutes.
4. Take them out and serve them. To store, refrigerate them in a glass container.

Steamed Chicken with Lemon and Thyme

Ingredients

Servings 4
2 lemons, thinly sliced
1 bunch thyme
4 chicken breasts
2 cloves of garlic, finely chopped
200 ml natural yoghurt
15 ml honey
5 ml Dijon mustard

Accessory

 Grill Tray
 Fill Water Tank

Time & Setting

approx. 19-22 minutes
Combi 3 (Steam + Microwave)

Method

1. Place the sliced lemons on the Grill Tray and scatter half of the thyme over them.
2. Place the chicken breasts between two sheets of cling film and flatten with a meat mallet or rolling pin until thin. Remove the cling film and place chicken on the lemon with the remaining finely chopped thyme. Add the garlic, pepper and salt.
3. Cook on the Grill Tray in lower shelf position on **Combi 3** for 19-22 minutes.
4. To make the Yogurt dressing, mix yogurt, honey, mustard and 2-3 crushed steamed garlic cloves (as prepared above) in a small bowl and stir well. Serve dressing with chicken and vegetables you prefer such as steamed broccoli or zucchini (please refer to cooking time charts on pages.108-109).



Pizza

Ingredients

Servings 2

2 onions, finely sliced

3 cloves of garlic, crushed

1 tbsp (15 ml) olive oil

1 roll pizza dough

100 ml passata (tomato sauce)

100 g mozzarella, grated

Optional: other pizza toppings
tomatoes, bell pepper, ham etc.

Accessory

 Grill Tray

Time & Setting

approx. 35-40 minutes

Oven 220 °C

Method

1. Place the finely sliced onions and garlic in a large Pyrex® bowl, with the olive oil. Cook on the base of the oven for 5 minutes on High Microwave. Leave to cool.
2. Preheat the oven on **Oven 220 °C**. Line the Grill Tray with baking paper. Using your hands, spread out the dough in the Grill Tray without making a raised edge.
3. Then add passata and other ingredients according to taste, olives, tomatoes, bell pepper, ham etc.
4. Cook on **Oven 220 °C** in lower shelf position for 11-13 minutes.
5. Add the cheese, and continue cooking on **Oven 220 °C** for 8-10 minutes.



Specifications

Manufacturer		Panasonic
Model		NN-DS59NB
Power Supply		230-240 V / 50 Hz
Operating Frequency		2450 MHz
Input Power	Maximum	1960 W
	Microwave	1010 W
	Grill	1400 W
	Oven	1500 W
	Steam	1180 W
Output Power	Microwave	1000 W (IEC-60705)
	Grill	1350 W
	Oven	1450 W
	Steam	1100 W
External Dimensions (W x D x H)		514 mm x 410 (456*) mm x 347 mm
Interior Dimensions (W x D x H)		336 mm x 357 mm x 226 mm
Uncrated Weight (approx.)		16 kg

Weight and Dimensions shown are approximate.

* 456 mm is the dimension with handle.

410 mm is the dimension without handle.

This product is an equipment that fulfills the European standard for EMC disturbances (EMC = Electromagnetic Compatibility) EN 55011. According to this standard this product is an equipment of group 2, class B and is within required limits. Group 2 means that radio-frequency energy is intentionally generated in the form of electromagnetic radiation for purpose of warming or cooking food. Class B means that this product may be used in normal household areas.

Manufactured by:

Panasonic Appliances Microwave Oven (Shanghai) Co., Ltd.
888, 898 Longdong Road. Pudong, Shanghai, 201203, China.

Imported by:

Panasonic UK, a branch of Panasonic Marketing Europe GmbH
Maxis 2, Western Road, Bracknell, Berkshire, RG12 1RT

Authorized Representative in EU:

Panasonic Marketing Europe GmbH, Panasonic Testing Centre
Winsbergring 15, 22525 Hamburg, Germany

A top-down view of a dark blue ceramic plate filled with golden-brown, spiced sweet potato fries. The fries are drizzled with a vibrant green herb sauce and sprinkled with white cheese and pine nuts. A small white bowl of the same green sauce sits to the right. A white line connects the text label to the fries.

Spiced Sweet Potato Fries

A top-down view of a pizza scene. A slice of pizza with tomato sauce, cheese, olives, and green peppers is served on a light blue ceramic plate. In the background, a wooden cutting board holds a red pepper mill and fresh basil leaves. A larger pizza on a wooden tray is visible on the right. A white line connects the text label to the slice on the plate.

Pizza



learn



cook



share

Scan the QR code for more recipes



experience-fresh.panasonic.eu/NN-DS59

**PHONE OUR
CUSTOMER COMMUNICATIONS CENTRE**

0344 844 3899

For service or spares.

Or order spares direct on line at
www.panasonic.co.uk

Panasonic Corporation
<http://www.panasonic.com>

© Panasonic Corporation 2022

F0003CM40BP
PA0122-0
Printed in P.R.C.