

Microwave Oven

User manual

NQ5B6753C**



SAMSUNG

Contents

Safety instructions	3
Important safety instructions	3
General safety	7
Microwave operation precautions	8
Limited warranty	8
Product group definition	8
Correct Disposal of This Product (Waste Electrical & Electronic Equipment)	9
Cooking instructions on food packaging	9
Cooking instructions	9
Installation	10
What's included	10
Installation instructions	11
Install in the cabinet	11
Before you start	14
Control panel	14
Initial settings	14
Side racks	15
About microwave energy	16
Cookware for microwave	16
Operations	18
Oven modes	18
Microwave modes	20
Special Function	22
Auto Cook	23

Auto Defrost	24
Speed Cook	24
Timer	25
Cleaning	25
Settings	26
Lock	28
Cooking Smart	28
Auto Cook	28
Auto Defrost	31
Speed Cook	32
Manual cooking	33
Quick & Easy	44
Maintenance	45
Cleaning	45
Replacement (repair)	46
Care against an extended period of disuse	46
Troubleshooting	46
Checkpoints	46
Information codes	51
Technical specifications	51
Appendix	52
Open Source Announcement	52

Safety instructions

IMPORTANT SAFETY INSTRUCTIONS

READ CAREFULLY AND KEEP FOR FUTURE REFERENCE.

WARNING: If the door or door seals are damaged, the oven must not be operated until it has been repaired by a competent person.

WARNING: It is hazardous for anyone other than a competent person to carry out any service or repair operation that involves the removal of a cover which gives protection against exposure to microwave energy.

WARNING: Liquids and other foods must not be heated in sealed containers since they are liable to explode.

WARNING: Only allow children to use the oven without supervision when adequate instructions have been given so that the child is able to use the oven in a safe way and understands the hazards of improper use.

This appliance is intended to be used in household only and it is not intended to be used such as:

- staff kitchen areas in shops, offices and other working environments;
- farm houses;

- by clients in hotels, motels and other residential environments;
- bed and breakfast type environments.

Only use utensils that are suitable for use in microwave ovens.

When heating food in plastic or paper containers, keep an eye on the oven due to the possibility of ignition.

The microwave oven is intended for heating food and beverages. Drying of food or clothing and heating of warming pads, slippers, sponges, damp cloth and similar may lead to risk of injury, ignition or fire.

If smoke is observed (emitted), switch off or unplug the appliance and keep the door closed in order to stifle any flames.

Microwave heating of beverages can result in delayed eruptive boiling, therefore care must be taken when handling the container.

The contents of feeding bottles and baby food jars shall be stirred or shaken and the temperature checked before consumption, in order to avoid burns.

Safety instructions

Eggs in their shell and whole hard-boiled eggs should not be heated in microwave ovens since they may explode, even after microwave heating has ended.

The oven should be cleaned regularly and any food deposits removed.

Failure to maintain the oven in a clean condition could lead to deterioration of the surface that could adversely affect the life of the appliance and possibly result in a hazardous situation.

The appliance is intended to be used built-in only. The appliance shall not be placed in a cabinet.

Metallic containers for food and beverages are not allowed during microwave cooking.

The care should be taken not to displace the turntable when removing containers from the appliance. (Turntable models only)

The appliance shall not be cleaned with a steam cleaner.

The appliance should not be cleaned with a water jet.

The appliance is not intended for installing in road vehicles, caravans and similar vehicles etc.

This appliance is not intended for use by persons (including children) with reduced physical, sensory or mental capabilities, or lack of experience and knowledge, unless they have been given supervision or instruction concerning use of the appliance by a person responsible for their safety.

Children should be supervised to ensure that they do not play with the appliance.

This appliance can be used by children aged from 8 years and above and persons with reduced physical, sensory or mental capabilities or lack of experience and knowledge if they have been given supervision or instruction concerning use of the appliance in a safe way and understand the hazards involved. Children shall not play with the appliance. Cleaning and user maintenance shall not be made by children without supervision.

This Appliance should be allowed to disconnect from the supply after installation. The disconnection may be achieved by having the plug accessible or by incorporating a switch in the fixed wiring in accordance with the wiring rules.

If supply cord without plug is installed on the appliance, the means for disconnection must be incorporated in the fixed wiring in accordance with the wiring rules.

If the supply cord is damaged, it must be replaced by the manufacturer, its service agent or similarly qualified persons in order to avoid a hazard.

The method of fixing stated is not to depend on the use of adhesives since they are not considered to be a reliable fixing means.

This oven should be positioned proper direction and height permitting easy access to cavity and control area.

Before using your oven first time, oven should be operated with the water during 10 minute and then used.

If the oven generates a strange noise, a burning smell, or smoke is emitted, unplug the power plug immediately and contact your nearest service center.

WARNING: When the appliance is operated in the combination mode, children should only use the oven under adult supervision due to the temperatures generated.

During use the appliance becomes hot. Care should be taken to avoid touching heating elements inside the oven.

If this appliance has cleaning function, during cleaning conditions, the surfaces may get hotter than usual and children should be kept away. The cleaning function depends on the model.

WARNING: Accessible parts may become hot during use. Young children should be kept away.

Do not use harsh abrasive cleaners or sharp metal scrapers to clean the oven door glass since they can scratch the surface, which may result in shattering of the glass.

A steam cleaner is not to be used.

WARNING: Ensure that the appliance is switched off before replacing the lamp to avoid the possibility of electric shock.

The appliance must not be installed behind a decorative door in order to avoid overheating.

Safety instructions

WARNING: The appliance and its accessible parts become hot during use.

Care should be taken to avoid touching heating elements.

Children less than 8 years of age shall be kept away unless continuously supervised.

CAUTION: The cooking process has to be supervised. A short term cooking process has to be supervised continuously.

The door or the outer surface may get hot when the appliance is operating.

The temperature of accessible surfaces may be high when the appliance is operating.

The surfaces are liable to get hot during use.

The Appliances are not intended to be operated by means of an external timer or separate remote-control system.

This appliance can be used by children aged from 8 years and above and persons with reduced physical, sensory or mental capabilities or lack of experience and knowledge if they have been given supervision or instruction concerning use of the appliance in a safe way and understand the hazards involved. Children shall not play with the appliance. Cleaning and user maintenance shall not be made by children unless they are older than 8 and supervised.

Keep the appliance and its cord out of reach of children less than 8 years.

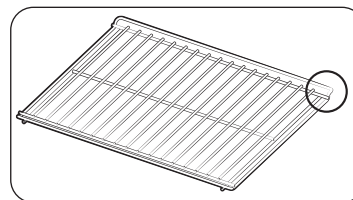

Please put the bent up frame side to the back, in order to support the reposition when cooking big loads. (Depending on model)

General safety

Any modifications or repairs must be performed by qualified personnel only.
Do not heat food or liquids sealed in containers for the microwave function.
Do not use benzene, thinner, alcohol, or steam or high-pressure cleaners to clean the oven.
Do not install the oven: near a heater or flammable material; locations that are humid, oily, dusty or exposed to direct sunlight or water; or where gas may leak; or an uneven surface.
This oven must be properly grounded in accordance with local and national codes. Regularly use a dry cloth to remove foreign substances from the power plug terminals and contacts.
Do not pull, excessively bend, or place heavy objects on the power cord.
If there is a gas leak (propane, LP, etc) ventilate immediately. Do not touch the power cord.
Do not touch the power cord with wet hands.
While the oven is operating, do not turn it off by unplugging the power cord.
Do not insert fingers or foreign substances. If foreign substances enter the oven, unplug the power cord and contact a local Samsung service centre.
Do not apply excessive pressure or impact to the oven.
Do not place the oven over fragile objects.
Ensure the power voltage, frequency, and current matches the product specifications.
Firmly plug the power plug into the wall socket. Do not use multiple plug adapters, extension cords, or electric transformers.
Do not hook the power cord on metal objects. Make sure the cord is between objects or behind the oven.
Do not use a damaged power plug, power cord, or loose wall socket. For damaged power plugs or cords, contact a local Samsung service centre.
Do not pour or directly spray water onto the oven.
Do not place objects on the oven, inside, or on the oven door.
Do not spray volatile materials such as insecticide on the oven.
Do not store flammable materials in the oven. Because alcohol vapours can contact hot parts of the oven, use caution when heating food or drinks containing alcohol. Children may bump themselves or catch their fingers on the door. When opening/closing the door, keep children away.

Microwave warning

Microwave heating of beverages may result in delayed eruptive boiling; always use caution when handling the container. Always allow beverages to stand at least 20 seconds before handling. If necessary, stir during heating. Always stir after heating.

In the event of scalding, follow these First Aid instructions:

1. Immerse the scalded area in cold water for at least 10 minutes.
2. Cover with a clean, dry dressing.
3. Do not apply any creams, oils, or lotions.

To avoid damaging the tray or rack, do not put the tray or rack in water shortly after cooking.

Do not use the oven for deep fat frying because the oil temperature cannot be controlled. This could result in a sudden boil over of hot oils.

Microwave oven precautions

Only use microwave-safe utensils. Do not use metallic containers, gold or silver trimmed dinnerware, skewers, etc.

Remove wire twist ties. Electric arcing may occur.

Do not use the oven to dry papers or clothes.

Use shorter times for small amounts of food to prevent overheating or burning.

Keep the power cord and power plug away from water and heat sources.

To avoid the risk of explosion, do not heat eggs with shells or hard-boiled eggs. Do not heat airtight or vacuum-sealed containers, nuts, tomatoes, etc.

Do not cover the ventilation slots with cloth or paper. This is a fire hazard. The oven may overheat and turn off automatically and will remain off until it cools sufficiently.

Always use oven mitts when removing a dish.

Stir liquids halfway during heating or after heating ends and allow the liquid stand at least 20 seconds after heating to prevent eruptive boiling.

Stand at arms length from the oven when opening the door to avoid getting scalded by escaping hot air or steam.

Do not operate the oven when it is empty. The oven will automatically shut down for 30 minutes for safety purposes. We recommend placing a glass of water inside the oven at all times to absorb microwave energy in case the oven is started accidentally.

Install the oven in compliance with the clearances in this manual. (See Installing your microwave oven.)

Use caution when connecting other electrical appliances to sockets near the oven.

Safety instructions

Microwave operation precautions

Failure to observe the following safety precautions may result in harmful exposure to microwave energy.

- Do not operate the oven with the door open. Do not tamper with the safety interlocks (door latches). Do not insert anything into the safety interlock holes.
- Do not place any object between the oven door and front face or allow food or cleaner residue to accumulate on sealing surfaces. Keep the door and door sealing surfaces clean by wiping with a damp cloth and then with a soft, dry cloth after each use.
- Do not operate the oven if it is damaged. Only operate after it has been repaired by a qualified technician.
Important: the oven door must close properly. The door must not be bent; the door hinges must not be broken or loose; the door seals and sealing surfaces must not be damaged.
- All adjustments or repairs must be done by a qualified technician.

Limited warranty

Samsung will charge a repair fee for replacing an accessory or repairing a cosmetic defect if the damage to the unit or accessory was caused by the customer. Items this stipulation covers include:

- Door, handles, out-panel, or control panel that are dented, scratched, or broken.
 - A broken or missing tray, guide roller, coupler, or wire rack.
- Use this oven only for its intended purpose as described in this instruction manual. Warnings and Important Safety Instructions in this manual do not cover all possible conditions and situations that may occur. It is your responsibility to use common sense, caution, and care when installing, maintaining, and operating your oven.

Because these following operating instructions cover various models, the characteristics of your microwave oven may differ slightly from those described in this manual and not all warning signs may be applicable. If you have any questions or concerns, contact a local Samsung service centre or find help and information online at www.samsung.com.

Use this oven for heating food only. It is intended for domestic use only. Do not heat any type of textiles or cushions filled with grains. The manufacturer cannot be held liable for damage caused by improper or incorrect use of the oven. To avoid deterioration of the oven surface and hazardous situations, always keep the oven clean and well maintained.

Product group definition

This product is a Group 2 Class B ISM equipment. The definition of group 2 which contains all ISM equipment in which radio-frequency energy is intentionally generated and/or used in the form of electromagnetic radiation for the treatment of material, and EDM and arc welding equipment.

For Class B equipment is equipment suitable for use in domestic establishments and in establishments directly connected to a low voltage power supply network which supplies buildings used for domestic purposes.

Correct Disposal of This Product (Waste Electrical & Electronic Equipment)

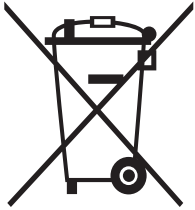

(Applicable in countries with separate collection systems)

This marking on the product, accessories or literature indicates that the product and its electronic accessories (e.g. charger, headset, USB cable) should not be disposed of with other household waste at the end of their working life. To prevent possible harm to the environment or human health from uncontrolled waste disposal, please separate these items from other types of waste and recycle them responsibly to promote the sustainable reuse of material resources.

Household users should contact either the retailer where they purchased this product, or their local government office, for details of where and how they can take these items for environmentally safe recycling.

Business users should contact their supplier and check the terms and conditions of the purchase contract. This product and its electronic accessories should not be mixed with other commercial wastes for disposal.

For information on Samsung's environmental commitments and product specific regulatory obligations e.g. REACH, WEEE, Batteries, visit: www.samsung.com/uk/aboutsamsung/sustainability/environment/our-commitment/data/

Cooking instructions on food packaging

Microwave Symbols

On the front of your oven there is a microwave oven symbol, as shown below.



This symbol has been introduced for your benefit when cooking or reheating packaged food. Packaged food is also, increasingly, using a microwave symbol similar to the one below. When you see this Symbol on food packaging, cooking instructions are based on either the IEC Power Output Rating, or the Reheating Categories A, B, C, D or E.

Cooking instructions

The IEC Power Output rating is an internationally standardised rating, so all microwave manufacturers now use the same method of measuring power output. If food packaging gives cooking instructions based on IEC Power ratings, set cooking times according to the IEC Power of your oven.

For example:

If the cooking instructions are based on a 650 W oven, then you will need to reduce some cooking time for the NQ5B6753C** (850 W).

Ready meals are now very convenient and popular. These are meals which are already prepared and cooked by the food manufacturer, and then frozen, chilled or vacuum sealed for long life.

Increasingly, heating times for such ready meals are being based on the Heating Categories A, B, C, D and E.

On this instance, simply match the heating category of your oven to the instructions on the food package, and set your timer accordingly.

For example:

If the heating instructions are 3 minutes on HIGH for a D category oven, then you will need to set your timer for less than 3 minutes on HIGH for the NQ5B6753C** (E category).

IMPORTANT: Always remember that cooking instructions are intended only as a guide. If you have followed the instructions and the food is still not piping hot throughout, simply return it to the oven and cook it until it is.

Installation

What's included

Make sure all parts and accessories are included in the product package. If you have a problem with the oven or accessories, contact a local Samsung customer centre or the retailer.

Oven at a glance

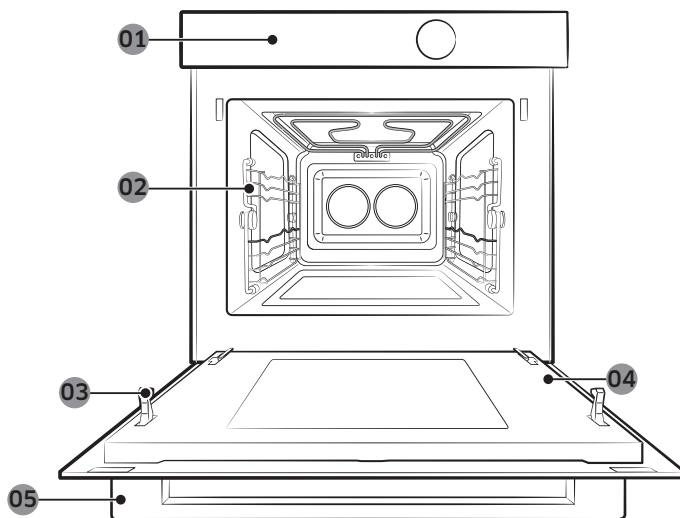

01 Control panel

02 Side racks

03 Safety door lock

04 Door

05 Door handle

Accessories

The oven comes with different accessories that help you prepare different types of food.



Ceramic tray
(Useful for microwave mode.)

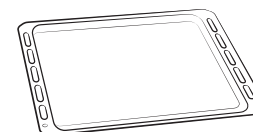

Baking tray
(Do not use for microwave mode.)



Wire tray insert
(Useful for speed menu and grill mode.)

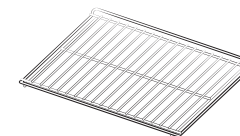

Oven rack
(Do not use for microwave mode.)

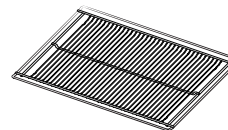

Air Fry rack
(Useful for Air Fry mode.)

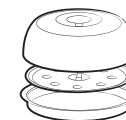

Pro Steamer
(Useful for microwave mode for steam cooking.)



3 Screws (M4 L25)

NOTE

See the **Cooking Smart** on page 28 to determine the appropriate accessory for your dishes.

Installation instructions

General technical information

Electrical Supply	230 V ~ 50 Hz	
Dimensions (W × H × D)	Set size	595 x 456 x 570 mm
	Built in size	560 x 446 x 549 mm

This appliance complies with EU regulations.

Disposal of packaging and appliance

Packaging is recyclable.

Packaging may consist of the following materials:

- cardboard;
- polyethylene film (PE);
- CFC-free polystyrene(PS rigid foam).

Please dispose of these materials in a responsible manner in accordance with government regulations.

The authorities can provide information on how to dispose of domestic appliances in a responsible manner.

Safety

- This appliance should only be connected by a qualified technician.
- The Oven is NOT designed for use in a commercial cooking setting.
- It should be used exclusively for cooking food in a home setting.
- The appliance is hot during and after use.
- Exercise caution when young children are present.

Electrical connection

The house mains to which the appliance is connected should comply with national and local regulations.

Appliance should allow to disconnection of the appliance from the supply after installation. The disconnection may be achieved by having the plug accessible or by incorporating a switch in the fixed wiring in accordance with the wiring rules.

Install in the cabinet

Kitchen cabinets in contact with the oven must be heatresistant up to 100 °C. Samsung will take no responsibility for damage of cabinets from the heat.

Required dimensions for installation (This product is dedicated to built-in products.)

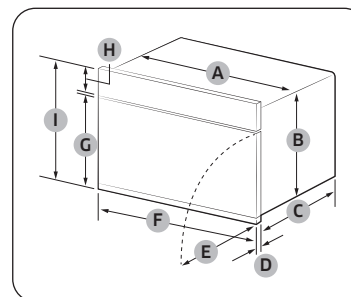

Oven (mm)

A	560	F	595
B	446	G	354
C	549	H	85
D	21	I	456
E	341		

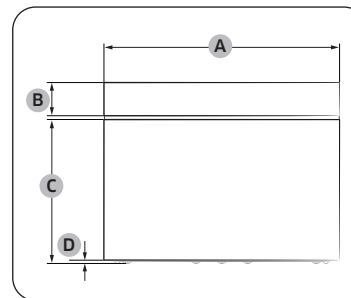

Oven (mm)

A	595
B	85
C	360
D	6

Installation

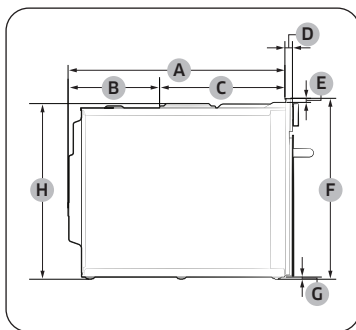

Oven (mm)

A	549	E	10
B	233	F	456
C	316	G	6
D	21	H	446

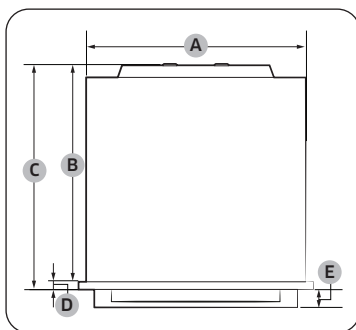

Oven (mm)

A	560	D	21
B	549	E	45
C	570		

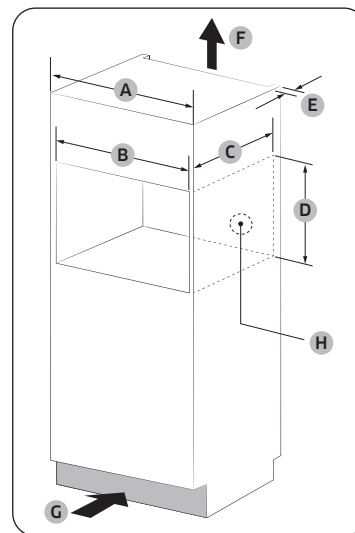

Built-in cabinet (mm)

A	600
B	Min. 564-568
C	Min. 550
D	Min. 446 / Max. 450
E	Min. 50
F	200 cm ²
G	200 cm ²
H	Space for power outlet (30 Ø Hole)

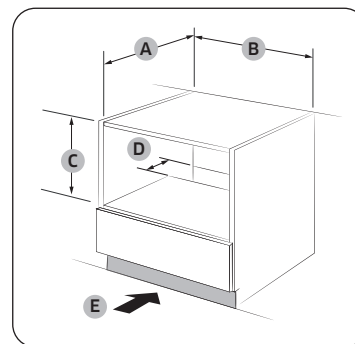

Under-sink cabinet (mm)

A	Min. 550
B	Min. 564 / Max. 568
C	Min. 446 / Max. 450
D	50
E	200 cm ²

NOTE

Minimum height requirement (C) is for oven installation alone.

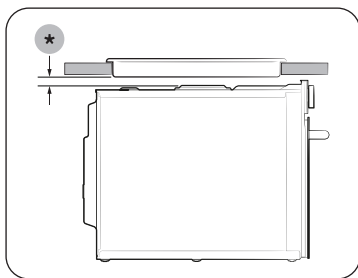

Installing with a hob

To install a hob on top of the oven, check the installation guide of the hob for the installation space requirement (*).

Mounting the oven

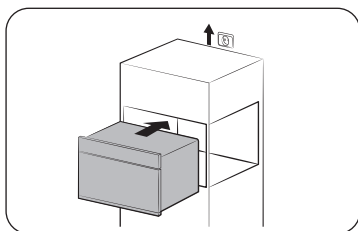

1. Slide the oven partly into the recess. Lead the connection cable to the power source.

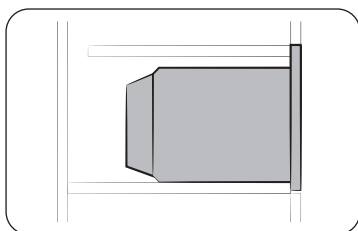

2. Slide the oven completely into the recess.

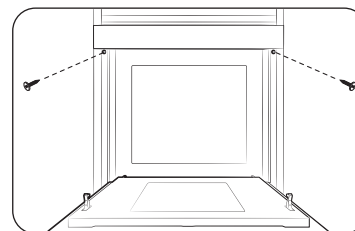

3. Fasten the oven using the two screws (4 x 25 mm) provided.

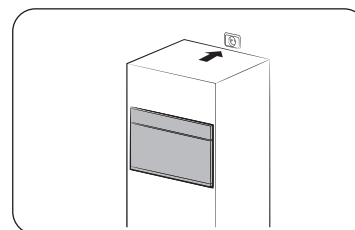

4. Make the electrical connection. Check that the appliance works.

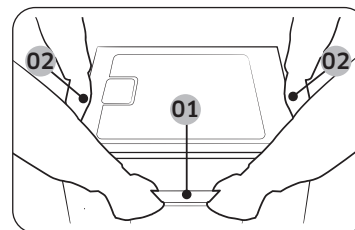

Be sure to hold the appliance with 2 side handles and door handle when unpacking the product.

- 01 Door handle
- 02 Side handle

After the installation is complete, remove the protective film, tape, and other packing material, and take out the provided accessories from inside of the oven. To remove the oven from the cabinet, first disconnect power to the oven and remove 2 screws on both sides of the oven.

Before you start

Control panel

The oven's control panel features a display (non-touch), dial knob and touch buttons to control the oven. Please read the following information to learn about the oven's control panel.

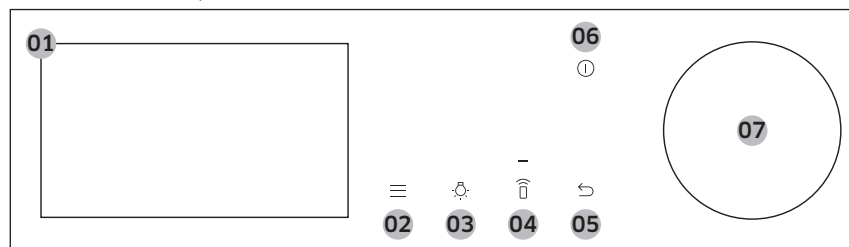

01 Screen	Displays the menu, information, and cooking progress.
02 Options	Tap to see the Options list.
03 Light	Tap to turn the oven light on or off.
04 Smart Control	Tap to turn the Smart Control function on or off. NOTE Easy Connection should be set prior to use this function.
05 Back	Tap to move to the previous screen.
06 Power	Tap to turn the screen on or off.
07 Dial Knob	Turn left and right to navigate through the menus and lists. An item will be underlined to show you where you are on the screen. Press to select the underlined item.

Initial settings

When you turn on the oven for the first time, the Welcome screen appears with the Samsung logo. Follow the on-screen instructions to complete the initial settings. You can change the initial settings later by accessing the Settings screen.

1. On the welcome screen, select **Start setup**, and then press the **Dial Knob**.
2. Set the language.
 - a. Select the language, and then press the **Dial Knob**.
 - b. Select **Next**, and then press the **Dial Knob**.
3. Agree with the "Terms and Conditions" and "Privacy Policy".
4. Connect your appliance to the SmartThings app.
 - a. On the Mobile Experience screen, select **Next**, and then press the **Dial Knob**.
 - b. Scan the QR code on the screen with your smartphone and follow the onscreen instruction on your phone to complete the connection.
 - If you do not wish to proceed this step, select **Skip**, and then press the **Dial Knob** to proceed next step.
 - c. Once you get the message that you are successfully connected, select **OK**, and then press the **Dial Knob**.

5. Set the time zone.
 - a. Select your time zone, and then press the **Dial Knob**.
 - b. Select **Next**, and then press the **Dial Knob**.
6. Set the date.
 - a. Select the day, month, and year. Press the **Dial Knob** after selecting each item.
 - b. Select **Next**, and then press the **Dial Knob**.

NOTE

Skip this step if you have connected your appliance to the SmartThings app.

7. Select the time.
 - a. Set the hour and minute. Press the **Dial Knob** after selecting each item.
 - b. Select **Next**, and then press the **Dial Knob**.

NOTE

Skip this step if you have connected your appliance to the SmartThings app.

8. Select **Done**, and then press the **Dial Knob** to complete the setting.
 - Guide for first use screen appears. You can select **LEARN MORE**, and then press the **Dial Knob** to see the guide or select **LATER**, and then press the **Dial Knob** to skip this step.

Side racks

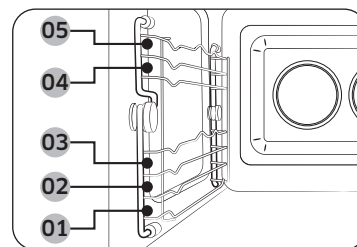

- Insert the accessory to the correct position inside of the oven.
- Take caution in removing cookware and/or accessories out of the oven. Hot meals or accessories can cause burns.

01 Level 1	Microwave function
02 Level 2	Oven function
03 Level 3	
04 Level 4	
05 Level 5	

Before you start

About microwave energy

Microwaves are high-frequency electromagnetic waves. The oven uses the prebuilt magnetron to generate microwaves which are used to cook or reheat food without deforming or discolouring the food.

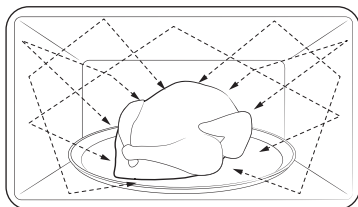

1. The microwaves generated by the magnetron are distributed uniformly through the whirling distribution system. This is why the food is cooked evenly.
2. The microwaves are absorbed down to the food up to a depth of approx. 2.5 cm. Then, the microwaves are dissipated inside the food as cooking continues.
3. The cooking time is affected by the following conditions of the food.
 - Quantity and density
 - Moisture content
 - Initial temperature (especially, when frozen)

NOTE

The cooked food keeps heat in its core after cooking is complete. This is why you must respect the standing time specified in this manual, which ensures cooking evenly down to the core.

Cookware for microwave

Cookware used for Microwave Mode must allow microwaves to pass through and penetrate food. Metals such as stainless steel, aluminum and copper reflect microwaves. Therefore, do not use cookware made of metallic materials. Cookware marked microwave-safe is always safe for use. For additional information on appropriate cookware, refer to the following guide.

Requirements:

- Flat bottom and straight sides
- Tight-fitting lid
- Well-balanced pan with handles that weigh less than the main pan

Material	Microwave-safe	Description
Aluminium foil	△	Use for a small serving size to protect against overcooking. Arcing can occur if the foil is near the oven wall or if using an excessive amount of foil.
Crusty plate	○	Do not use for preheating for more than 8 minutes.
Bone china or earthenware	○	Porcelain, pottery, glazed earthenware and bone china are usually microwave-safe, unless decorated with a metal trim.
Disposable polyester cardboard dishes	○	Some frozen foods are packaged in these dishes.

Material		Microwave-safe	Description
Fast-food packaging	Polystyrene cups or containers	○	Overheating may cause these to melt.
	Paper bags or newspaper	✗	These may catch fire.
	Recycled paper or metal trims	✗	These may cause arcing
Glassware	Oven-to-table ware	○	Microwave-safe unless decorated with metal trims.
	Fine glassware	○	Delicate glassware may break or crack by rapid heating.
	Glass jars	○	Appropriate for warming only. Remove the lid before cooking.
Metal	Dishes	✗	These may cause arcing or fire.
	Freezer bag with twist-ties	✗	
Paper	Plates, cups, napkins, and kitchen paper	○	Use to cook for a short time. These absorb excess moisture.
	Recycled paper	✗	Causes arcing.

Material		Microwave-safe	Description
Plastic	Containers	○	Use thermoplastic containers only. Some plastics may warp or discolour at high temperatures.
	Cling film	○	Use to maintain moisture after cooking.
	Freezer bags	△	Use boilable or ovenproof bags only.
Wax or grease-proof paper		○	Use to maintain moisture and prevent spattering.

○ : Microwave safe

△ : Use caution

✗ : Microwave unsafe

Operations

Oven modes

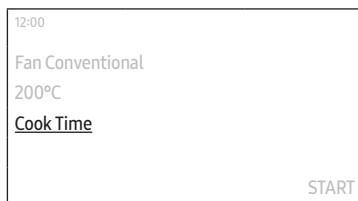
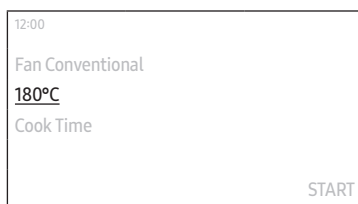
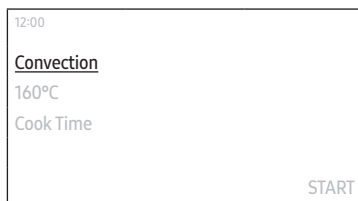

1. On the main screen, select **Convection**, and then press the **Dial Knob**.
2. Select the desired cook mode, and then press the **Dial Knob**.
(For detailed information of each mode, see “Oven mode descriptions” section on page 19.)
3. Set the desired temperature.
 - The default temperature and the temperature range differ depending on the cook mode.
4. Select **Cook Time**, and then press the **Dial Knob** to set the desired cooking time.
 - Maximum cooking time is 10 hours.
5. After setting the cooking time, select the option you want to run at the end of cooking, and then press the **Dial Knob**.
 - You can select **Oven Off, Keep Temp.,** or **Keep Warm**.
 - The Large Grill mode does not support the **Keep Warm** option.

NOTE

If you start cooking without setting the cooking time or set **Keep Temp.** for option, you must stop the oven manually.

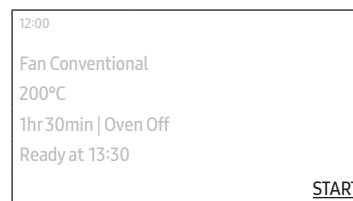
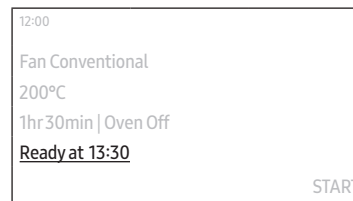

6. Select **Ready at**, and then press the **Dial Knob** to set the desired end time.
 - When you set the cooking time, the oven displays the time the cooking will end. (Ex. **Ready at 13:30**)
7. Select **START**, and then press the **Dial Knob**.
 - If you did not change the end time, the oven starts cooking immediately.
 - If you changed the end time, the oven will automatically adjust the start time to end the cooking at the set time.

NOTE

- You can change the temperature and cooking time during cooking.
- During cooking, select **Pause**, and then press the **Dial Knob** to pause. Once you pause cooking, you can either end or continue cooking.
 - Select **OFF**, and then press the **Dial Knob** to end cooking.
 - Select **Continue**, and then press the **Dial Knob** to continue cooking.
- When cooking is complete, **+5 mins** appears on the screen.
 - You can select **+5 mins**, and then press the **Dial Knob** to extend the cooking for 5 more minutes.

Oven mode descriptions

Mode	Temperature range (°C)	Default temperature (°C)
Convection	40-250	160
	The rear heating element generates heat, which is evenly distributed by the convection fan. Use this mode for baking and roasting on different levels at the same time.	
Fan Conventional	40-250	180
	The heat is generated from the top and bottom heating elements with fans. This setting is suitable for baking and roasting.	
Large Grill	150-250	220
	The large-area grill emits heat. Use this mode for browning the tops of food (for example, meat, lasagne, or gratin).	
Fan Grill	40-250	180
	Two top heating elements generate heat, which is distributed by the fan. Use this mode for grilling meat or fish.	
Top Heat + Convection	40-250	180
	The top heating element generates heat, which is evenly distributed by the convection fan. Use this mode for roasting that requires a crispy top (for example, meat or lasagne).	

Mode	Temperature range (°C)	Default temperature (°C)
Bottom Heat + Convection	40-250	200
	The bottom heating element generates heat, which is evenly distributed by the convection fan. Use this mode for pizza, bread, or cake.	
Intensive Cook	40-250	220
	Intensive cook activates all heating elements alternately to distribute heat evenly inside the oven. Use this mode for large recipes, such as large gratins or pies.	
Pro-Roasting	80-200	160
	Pro-Roasting runs an automatic pre-heating cycle until the oven temperature reaches 220 °C. Then, the top heating element and the convection fan start operating to sear food such as meat. After searing, the meat will be cooked at low temperatures. Use this mode for beef, poultry, or fish.	
Air Fry	150-250	220
	Air Fry uses hot air for crispier and healthier frozen or fresh foods without, or less oil, than normal convection modes. For best results, use this mode on a Air fry tray. Follow recipe or package directions for set temperature, time and quantity.	

Operations

Microwave modes

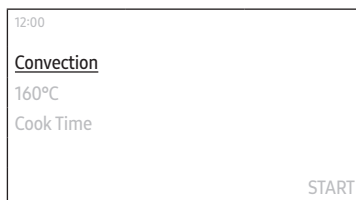

1. On the main screen, select **Convection**, and then press the **Dial Knob**.
2. Select the desired cook mode, and then press the **Dial Knob**.
(For detailed information of each mode, see "Microwave mode descriptions" section on page 21.)
3. Set the desired temperature.
 - MWO mode does not require temperature setting.
 - The default temperature and the temperature range differ depending on the cook mode.
4. Set the power level.
 - The default power level and the power level range differ depending on the cook mode.



5. Select **Cook Time**, and then press the **Dial Knob** to set the desired cooking time.
 - Maximum cooking time is 1 hour and 30 minutes.
 - You can select **+30 secs**, and then press the **Dial Knob** to add 30 seconds of cooking time.
6. Select **START**, and then press the **Dial Knob**.
 - The oven starts cooking immediately.

NOTE

- You can change the temperature and cooking time during cooking.
- During cooking, select **Pause**, and then press the **Dial Knob** to pause. Once you pause cooking, you can either end or continue cooking.
 - Select **OK**, and then press the **Dial Knob** to end cooking.
 - Select **Continue**, and then press the **Dial Knob** to continue cooking.
- When cooking is complete, **+30 secs** appears on the screen. (**+30 secs** does not appear if the cook time was set to less than 5 seconds.)
 - You can select **+30 secs**, and then press the **Dial Knob** to extend the cooking for 30 more seconds.

Microwave mode descriptions

Mode	Temperature (°C) / Power level (W) range	Default temperature (°C) / Power level (W)
MWO	- / 100-850	850
	The microwave energy enables food to be cooked or reheated without changing either the form or the colour.	
MWO + Grill	40-200 / 100-600	200 / 300
	The heating elements generate heat, which is reinforced by the microwave energy.	
MWO + Convection	40-200 / 100-600	180 / 300
	The heating elements generate heat and the convection fan distributes the heat inside the oven, which is reinforced by the microwave energy.	
MWO + Roast	40-200 / 100-600	180 / 300
	This mode combines Fan grill and microwave and is, therefore, reducing the cooking time while giving the food a brown and crispy surface.	

Power level

Level	Percentage (%)	Output power (W)	Description
HIGH	100	850	Use to heat up liquid.
HIGH LOW	82	700	Use to heat up and cook.
MEDIUM HIGH	71	600	
MEDIUM	53	450	Use to cook meat and heat up vegetables.
MEDIUM LOW	35	300	
DEFROST	21	180	Use to defrost before cooking.
LOW	12	100	Use to defrost vegetables.

To use Pro Steamer

You can manually steam cook your food using Pro Steamer.

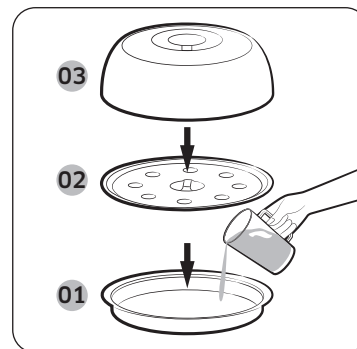

- 01 Steam plate / Crusty plate
- 02 Steam tray
- 03 Stainless steel lid

1. Pour 500 ml of cold water into the steam plate. Put the steam tray on the steam plate, add food on the tray, and then close the stainless steel lid. Put Pro Steamer in the centre of the cavity.
2. Follow the steps 2-4 in the Microwave section for the rest of the cook settings.
 - For detailed cooking instructions, refer to the **Pro Steamer** on page 40.

NOTE

Always check your cooking settings before leaving the oven unattended.

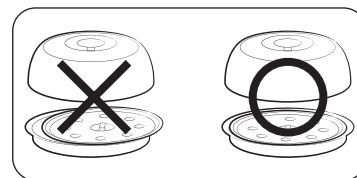

CAUTION

Make sure you close the lid onto the Pro steamer so that it fits into the steam plate/crusty plate. The eggs or the chestnuts may explode if the lid is not closed properly.

CAUTION

- Never use this Pro Steamer with a different product or model. It may cause a fire or fatal damage to the product.
- Do not use the Pro Steamer without water or food inside. When you use this Pro Steamer, pour at least 500 ml of water before use. If the amount of water is less than 500 ml, it may cause incomplete cooking, or may cause a fire or fatal damage to the product.
- Caution must be taken when removing the container from inside the Pro Steamer after cooking, as it will be very hot.

Operations

Special Function

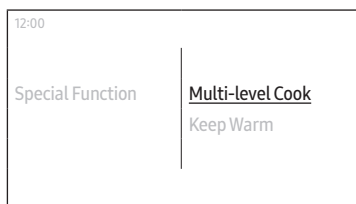
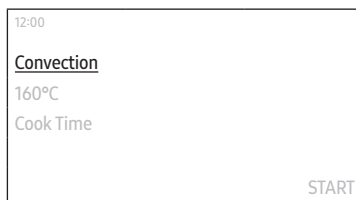

1. On the main screen, select **Convection**, and then press the **Dial Knob**.
2. Select **Special Function**, and then press the **Dial Knob**.
3. Select the desired function, and then press the **Dial Knob**.
(For detailed information of each function, see “**Special Function descriptions**” section on page 23.)
4. Set the desired temperature.
 - The default temperature and the temperature differ depending on the cook mode.
5. Select **Cook Time**, and then press the **Dial Knob** to set the desired cooking time.
 - Maximum cooking time is 10 hours.

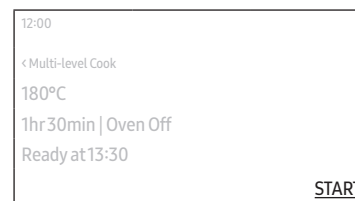
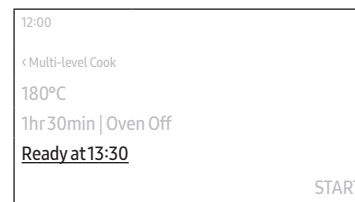

6. Select **Ready at**, and then press the **Dial Knob** to set the desired end time.
 - When you set the cooking time, the oven displays the time the cooking will end. (Ex. **Ready at 13:30**)
7. Select **START**, and then press the **Dial Knob**.
 - If you did not change the end time, the oven starts cooking immediately.
 - If you changed the end time, the oven will automatically adjust the start time to end the cooking at the set time.

Special Function descriptions

Mode	Temperature range (°C)	Default temperature (°C)
Multi-level Cook	40-250	160
	Use this for cooking with two multi-levels at the same time.	
Keep Warm	60-100	60
	Use this only for keeping foods warm that has just been cooked.	

Auto Cook

The oven offers 31 Auto Cook programmes. Take advantage of this feature to save your time or shorten your learning curve. The cooking time, power level and temperature will be adjusted according to the selected programme.

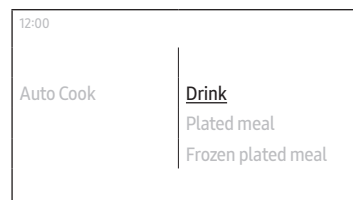
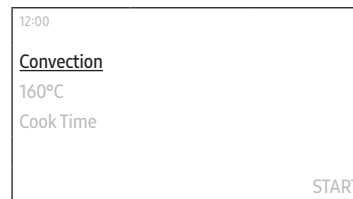

1. On the main screen, select **Convection**, and then press the **Dial Knob**.
2. Select **Auto Cook**, and then press the **Dial Knob**.
3. Select the desired programme, and then press the **Dial Knob**.
 - For detailed information of each programme, see "Auto Cook" in "Cooking Smart" section on page 28.
4. Read the tip, select **Next**, and then press the **Dial Knob**.
5. Select the weight, and then press the **Dial Knob**.
 - Available weight differs depending on the selected programme.
 - This step may not apply to some programmes.
6. Prepare food and accessories as instructed on the screen, select **Next**, and then press the **Dial Knob**.
7. Select **START**, and then press the **Dial Knob**.

Operations

Auto Defrost

The oven offers 5 Auto Defrost programmes. Take advantage of this feature to conveniently defrost items. The cooking time, power level and temperature will be adjusted according to the selected programme.

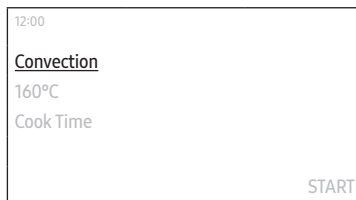

1. On the main screen, select **Convection**, and then press the **Dial Knob**.
2. Select **Auto Defrost**, and then press the **Dial Knob**.



3. Select the desired programme, and then press the **Dial Knob**.
 - For detailed information of each programme, see “Auto Defrost” in “Cooking Smart” section on page 31.



4. Select the weight, and then press the **Dial Knob**.
 - Available weight differs depending on the selected programme.
5. Prepare food and accessories as instructed on the screen, select **Next**, and then press the **Dial Knob**.
6. Select **START**, and then press the **Dial Knob**.

Speed Cook

The oven offers Speed Cook programmes. Take advantage of this feature to conveniently defrost items. The cooking time, power level and temperature will be adjusted according to the selected programme.

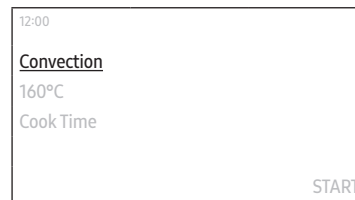

1. On the main screen, select **Convection**, and then press the **Dial Knob**.
2. Select **Speed Cook**, and then press the **Dial Knob**.

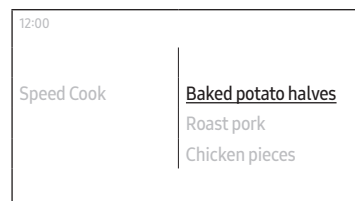

3. Select the desired programme, and then press the **Dial Knob**.
 - For detailed information of each programme, see “Speed Cook” in “Cooking Smart” section on page 32.



4. Read the tip, select **Next**, and then press the **Dial Knob**.
5. Select the weight, and then press the **Dial Knob**.
 - Available weight differs depending on the selected programme.
6. Prepare food and accessories as instructed on the screen, select **Next**, and then press the **Dial Knob**.
7. Select **START**, and then press the **Dial Knob**.

Timer



Adding the new timer

1. Touch the  button on the control panel.
2. Select **Timer**, and then press the **Dial Knob**.
3. On the Timer screen, select **+**, and then press the **Dial Knob**.
 - Skip this step if you are adding the timer for the first time.
4. Set the time.

Editing the existing timer

1. Touch the  button on the control panel.
2. Select **Timer**, and then press the **Dial Knob**.
3. On the Timer screen, select the Timer you want to edit, and then press the **Dial Knob**.
4. Change the time.

Deleting the timer

1. Touch the  button on the control panel.
2. Select **Timer**, and then press the **Dial Knob**.
3. On the Timer screen, select , and then press the **Dial Knob**.
4. Select **Delete** on the right side of the Timer you want to delete, and then press the **Dial Knob**.
5. Select **Done**, and then press the **Dial Knob**.

Using the timer

1. Touch the  button on the control panel.
2. Select **Timer**, and then press the **Dial Knob**.
3. Select **START** on the right side of the Timer you want to use, and then press the **Dial Knob**.
 - Once you start the timer, you can pause or cancel the timer.

NOTE

When the time has elapsed to a set point, a message of “**Time is up.**” appears with a melody. Select **OK**, and then press the **Dial Knob** to dismiss the message.

Cleaning

Steam Clean

This is useful for cleaning light soiling with steam.

This automatic function saves you time by removing the need for regular manual cleaning.

1. Touch the  button on the control panel.
2. Select **Cleaning**, and then press the **Dial Knob**.
3. Select **Steam Clean**, and then press the **Dial Knob**.
4. Follow the instruction on the screen, select **Next**, and then press the **Dial Knob**.
5. Select **START**, and then press the **Dial Knob**.

WARNING

Do not open the door before the cycle is complete. The water inside the oven is very hot, and it can cause a burn.

NOTE

- If the oven is heavily soiled with grease, for example, after roasting or grilling, it is recommended to remove stubborn soil manually using a cleaning agent before activating Steam cleaning.
- Leave the oven door ajar when the cycle is complete. This is to allow the interior enamel surface to dry thoroughly.
- While the oven is hot inside, auto cleaning is not activated. Wait until the oven cools down, and try again.
- Do not pour water onto the bottom by force. Do it gently. Otherwise, the water overflows to the front.

Operations

Deodorisation

This is useful for deodorizing the oven. Use this function regularly to remove any unpleasant odor in your oven.



1. Touch the  button on the control panel.
2. Select **Cleaning**, and then press the **Dial Knob**.
3. Select **Deodorisation**, and then press the **Dial Knob**.
4. Set the time.
 - You can set up to 15 minutes.
5. Select **START**, and then press the **Dial Knob**.

Settings

Touch the  button on the control panel, select **Settings**, and then press the **Dial Knob** to change various settings for your oven.

Please refer to the following table for detailed descriptions.

Menu	Submenu	Description
Connections	Wi-Fi	You can turn the Wi-Fi on or off.
	Easy Connection	You can connect the oven to the SmartThings server via a Wi-Fi connection. When the oven is connected, you can use the SmartThings app to check the status of the oven and/or control it from a mobile device.
	Remote management	Select Activate , and then press the Dial Knob to allow the Call Centre to access your oven remotely to check internal information.

Menu	Submenu	Description
Display	Brightness	You can change the brightness of the display screen.
	Screen saver	You can turn the screen saver on or off.  NOTE <ul style="list-style-type: none"> The Screen saver is a function that displays the date and time on your screen if there is no input for a certain time in standby status. Turn on Screen saver to activate Clock theme and Timeout.
	Clock theme	You can select the clock theme.
	Timeout	You can set the length of time before the screen saver turns on.  NOTE <ul style="list-style-type: none"> Energy consumption may increase depending on your setting. When the timeout setting is set to "Always on", the brightness of the LCD automatically changes to level 2 if there is no action for 3 minutes.



Menu	Submenu	Description
Date & time	Automatic date and time	You can turn on or turn off to update time from the Internet. You must be connected to the Wi-Fi network.
	Select time zone	You can select the time zone. (You must disable Automatic date and time.)
	Set date	You can manually set a date. (You must disable Automatic date and time.)
	Set time	You can manually set time. (You must disable Automatic date and time.)
	Select time format	You can select the time format from 12-hour or 24-hour format.
Language		You can select a language.
Volume		You can adjust the volume of the oven.
Help	Troubleshooting	You can check the troubleshooting.
	Guide for first use	You can check the simple instructions on basic use of the oven.

Operations

Menu	Submenu	Description
About device	Model name	You can check the model name of our oven.
	SW version	You can check the current version of the firmware. When you have new software available, SW update button will appear on this menu.
	Legal information	You can check the legal information.

Lock

You can lock the control panel to prevent any unintended operation.

- To activate the **Lock** function, touch the  button on the control panel, select **Lock**, and then press the **Dial Knob**.
- To deactivate the **Lock** function, touch and hold the  button until you see the 'Control is unlocked.' message.

Cooking Smart

Auto Cook

The following table presents 31 Auto programmes including reheating, cooking, roasting and baking. It contains its quantities, standing times, and appropriate recommendations. These auto programmes contain special cook modes, which have been developed for your convenience.

Food	Serving size (kg)	Accessory	Level
1. Drink	0.25 0.5	Ceramic tray	1
	Pour the liquid into ceramic mugs and reheat uncovered. Place one mug in the centre, Place 2 mugs side by side on ceramic tray. Leave them to stand in the microwave oven. Stir well after 1-2 min standing. Be careful while taking the cups out (see safety instructions for reheating liquids).		
2. Plated meal	0.3-0.4 0.4-0.5	Ceramic tray	1
	Put on a ceramic plate and cover with microwave cling film. This programme is suitable for meals consisting of 3 components (e.g. meat with sauce, vegetables and a side dish like potatoes, rice or pasta). After cooking stand for 3 min.		
3. Frozen plated meal	0.3-0.4 0.4-0.5	Ceramic tray	1
	Take frozen ready meal and check if dish is suitable for microwave. Pierce film of ready meal. Put the frozen ready meal in the centre. This programme is suitable for frozen ready meals consisting of 3 components (e.g. meat with sauce, vegetables and a side dish like potatoes, rice or pasta). After cooking stand for 3 min.		

Food	Serving size (kg)	Accessory	Level
4. Soup	0.2-0.3 0.4-0.5	Ceramic tray	1
	Pour into a deep ceramic plate or bowl and cover with plastic lid during heating. Put soup in the centre of ceramic tray. Stir carefully before and after 2-3 min standing.		
5. Stew	0.2-0.3 0.4-0.5	Ceramic tray	1
	Pour into a deep ceramic plate or bowl and cover with plastic lid during heating. Put soup in the centre of ceramic tray. Stir carefully before and after 2-3 min standing.		
6. Frozen fish gratin	0.4-0.6	Grill insert + Ceramic tray	3
	Put frozen fish gratin in a suitable glass pyrex or ceramic dish. After cooking stand for 2-3 minutes. This programme is suitable for frozen ready products consisting of fillets topped with vegetables and sauce.		
7. Frozen lasagne	0.4-0.6	Grill insert + Ceramic tray	3
	Put frozen lasagne in a suitable glass pyrex or ceramic dish. After reheating let stand for 2-3 minutes.		
8. Frozen oven chips	0.4-0.5	Baking tray	3
	Distribute frozen oven chips on metal baking tray.		
9. Frozen pizza	0.3-0.4 0.4-0.5	Oven rack	2
	Put frozen pizza on oven rack.		

Food	Serving size (kg)	Accessory	Level
10. Frozen croquettes	0.4-0.6	Baking tray	3
	Put frozen potato croquettes evenly on metal baking tray.		
11. Frozen vegetables	0.3-0.4 0.4-0.5	Ceramic tray	1
	Put frozen vegetables, such as broccoli, carrot slices, cauliflower florets and peas into a glass bowl with lid. Add 1-2 tbsp. water. Put bowl in the centre of ceramic tray. Cook covered. Stand 2-3 minutes and stir after cooking.		
12. Apple pie	1.2-1.4	Oven rack	1
	Put apple pie into a round metal dish. Put on the oven rack. The weight ranges include apple and so on.		
13. Base for fruit pie	0.3-0.5	Oven rack	3
	Put batter into metal base dish on the oven rack.		
14. Brownies	0.5-0.7	Oven rack	3
	Put dough into a round glass pyrex and ceramic dish on the oven rack.		
15. Croissants	0.2-0.4	Oven rack	3
	Use baking paper. Put croissants side by side on the oven rack.		
16. Dutch butter pie	0.5-0.7	Oven rack	2
	Put fresh dough into a 22 cm round metal baking dish. Put on the rack.		
17. Dutch loaf cake	0.7-0.8	Oven rack	3
	Put fresh dough into suitable sized rectangular metal baking dish(length 25 cm). Put dish lengthway to the door on oven rack.		

Cooking Smart

Food	Serving size (kg)	Accessory	Level
18. Muffins	0.5-0.6	Oven rack	2
	Put muffin dough into metal muffin dish, suitable for 12 muffins. Set dish in the middle of oven rack.		
19. Rising yeast dough	0.3-0.6	Oven rack	3
	Prepare yeast dough for pizza, cake or bread. Put into a large round heat-resistant dish and cover with cling film.		
20. Sponge cake	0.3-0.6	Oven rack	2
	Put 300 g dough into 18 cm, 400 g into 24 cm and 500 g into 26 cm diameter round black metal baking dish. Set dish in the middle of oven rack.		
21. White bread	0.7-0.8	Oven rack	2
	Put fresh dough into suitable sized rectangular metal baking dish (length 25 cm). Put dish lengthway to the door on oven rack.		
22. Apple puff pastry	0.3-0.5	Baking tray	2
	Use baking paper. Put 4 pcs side by side on the baking tray.		
23. Fish fillet, 2 cm	0.3-0.6	Oven rack + Baking tray	5+2
	Marinate fish fillet (2 cm) and put side by side on oven rack and baking tray. Turn the food over when the notification pops up, select OK , and then press the Dial Knob . Then, select Continue , and then press the Dial Knob to resume process.		

Food	Serving size (kg)	Accessory	Level
24. Salmon steak	0.3-0.6	Oven rack + Baking tray	5+2
	Marinate salmon steaks and put side by side on oven rack and baking tray. Turn the food over when the notification pops up, select OK , and then press the Dial Knob . Then, select Continue , and then press the Dial Knob to resume process.		
25. Prawns	0.3-0.4 0.4-0.5	Oven rack + Baking tray	5+2
	Put the raw prawn on oven rack and baking tray evenly. Turn the food over when the notification pops up, select OK , and then press the Dial Knob . Then, select Continue , and then press the Dial Knob to resume process.		
26. Beef steak, thin	0.3-0.6	Oven rack + Baking tray	5+2
	Put beef steaks side by side in the middle of oven rack and baking tray. Turn the food over when the notification pops up, select OK , and then press the Dial Knob . Then, select Continue , and then press the Dial Knob to resume process.		
27. Lamb chops	0.3-0.6	Oven rack + Baking tray	5+2
	Marinate lamb chops. Put lamp chops on oven rack and baking tray. Turn the food over when the notification pops up, select OK , and then press the Dial Knob . Then, select Continue , and then press the Dial Knob to resume process.		

Food	Serving size (kg)	Accessory	Level
28. Fresh vegetables	0.3-0.4 0.5-0.6	Ceramic tray	1
	Weigh the vegetables after washing, cleaning and cutting into similar size. Put them into a glass bowl with lid. Add 45 ml water (3 tablespoons). Put bowl in the centre of ceramic tray. Cook covered. Stand 2-3 minutes and stir after cooking.		
29. Peeled potato	0.5-0.6 0.7-0.8	Ceramic tray	1
	Weigh the potatoes after peeling, washing and cutting into a similar size. Put them into a glass bowl with lid. Add 45-60 ml (3-4 tablespoons) water. Put bowl in the centre of ceramic tray. Stand 2-3 minutes and stir after cooking.		
30. White rice	0.3-0.4	Ceramic tray	1
	Weigh parboiled white rice and add double quantity of cold water. For example: when cooking 0.3 kg rice, add 600 ml cold water. Use glass pyrex bowl with lid. Put bowl in the centre of ceramic tray. Cook covered. Stand 5 minutes and stir after cooking.		
31. Homemade pizza	0.6-1.0	Baking tray	1
	Put pizza on the tray. The weight ranges include topping such as sauce, vegetables, ham and cheese.		

Auto Defrost

The following table presents the various Auto Defrost programmes, quantities, standing times and appropriate recommendations. These programmes use microwave energy only. Remove all packaging material before defrosting. Place meat, poultry, fish, bread, cake, and fruit on the ceramic tray.

Food	Serving size (kg)	Accessory	Level	Standing time (min.)
Meat	0.2-2.0	Ceramic tray	1	10-30
	Shield the edges with aluminium foil. Turn the food over when the notification pops up, select OK , and then press the Dial Knob . Then, select Continue , and then press the Dial Knob to resume process. This programme is suitable for beef, lamb, pork, steaks, chops, minced meat.			
Poultry	0.2-2.0	Ceramic tray	1	10-30
	Shield the leg and wing tips with aluminium foil. Turn the food over when the notification pops up, select OK , and then press the Dial Knob . Then, select Continue , and then press the Dial Knob to resume process. This programme is suitable for whole chicken as well as for chicken portions.			
Fish	0.2-2.0	Ceramic tray	1	10-30
	Shield the tail of a whole fish with aluminium foil. Turn the food over when the notification pops up, select OK , and then press the Dial Knob . Then, select Continue , and then press the Dial Knob to resume process. This programme is suitable for whole fishes as well as for fish fillets.			

Cooking Smart

Food	Serving size (kg)	Accessory	Level	Standing time (min.)
Bread/ Cake	0.1-1.0	Ceramic tray	1	5-10
	Put bread on a piece of paper towel. Turn the food over when the notification pops up, select OK , and then press the Dial Knob . Then, select Continue , and then press the Dial Knob to resume process. Oven keeps operating until you open the door to turn the food over. This programme is suitable for all kinds of bread, sliced or whole, as well as for bread rolls and baguettes. Arrange bread rolls in a circle. This programme is suitable for all kinds of yeast cake, biscuit, cheese cake and puff pastry. It is not suitable for short / crust pastry, fruit and cream cakes as well as for cake with chocolate topping.			
Fruit	0.1-0.8	Ceramic tray	1	5-10
	Distribute frozen fruit evenly on ceramic tray. This programme is suitable for fruits like raspberries, mixed berries, and tropical fruits.			

Speed Cook

The following table presents 4 auto programmes for speed cooking and roasting. It contains its quantities, standing times and appropriate recommendations. These auto programmes contain special cook modes, which have been developed for your convenience.

Food item	Weight	Accessory	Shelf level
Baked potato halves	400-600 g	Grill insert + Ceramic tray	3
	600-800 g		
Cut potatoes into halves. Put them in the rack with the cut side to the grill. After cooking let stand for 2-3 minutes.			

Food item	Weight	Accessory	Shelf level
Roast pork	0.8-1.0 kg	Grill insert + Ceramic tray	3
	Put marinated roast pork on grill insert rack with ceramic tray. Turn the food over when the notification pops up, select OK , and then press the Dial Knob . Then, select Continue , and then press the Dial Knob to resume process.		
Chicken pieces	0.5-0.7 kg 1.0-1.2 kg	Grill insert + Ceramic tray	5
	Brush chilled chicken pieces with oil and spices. Put on grill insert with ceramic tray with the skin-side down. Turn the food over when the notification pops up, select OK , and then press the Dial Knob . Then, select Continue , and then press the Dial Knob to resume process. After cooking let stand for 2-3 minutes.		
Whole chicken	1.0-1.1 kg 1.2-1.3 kg	Grill insert + Ceramic tray	3
	Brush chilled chicken with oil and spices. Put breast-side-down, in the middle of grill insert rack with ceramic tray in shelf level 3. Turn the food over when the notification pops up, select OK , and then press the Dial Knob . Then, select Continue , and then press the Dial Knob to resume process. After cooking let stand for 5 minutes.		

※ The Speed Cook mode uses microwave energy to heat food. Therefore, guidelines for cookware and other microwave safety precautions must be strictly observed when using this mode.

Manual cooking

Microwave cooking guide

- Do not use metal containers with Microwave mode. Always put food containers on the cavity.
- It is recommended to cover the food for best results.
- After cooking is complete, let the food settle in its own steam.

Frozen vegetables

- Use a glass Pyrex container with a lid.
- Stir vegetables twice during cooking, and once after cooking.
- Add seasoning after cooking.

Food	Serving size (g)	Power (W)	Cooking time (min.)	Standing time (min.)
Spinach	150	600	5-6	2-3
	Add 15 ml (1 tbsp.) of cold water.			
Broccoli	300	600	8-9	2-3
	Add 30 ml (2 tbsp.) of cold water.			
Peas	300	600	7-8	2-3
	Add 15 ml (1 tbsp.) of cold water.			
Green Beans	300	600	7½-8½	2-3
	Add 30 ml (2 tbsp.) of cold water.			
Mixed Vegetables (Carrots/Peas/Corn)	300	600	7-8	2-3
	Add 15 ml (1 tbsp.) of cold water.			
Mixed Vegetables (Chinese Style)	300	600	7½-8½	2-3
	Add 15 ml (1 tbsp.) of cold water.			

Fresh vegetables

- Use a glass Pyrex container with a lid.
- Add 30-45 ml of cold water for every 250 g.
- Stir once during cooking, and once after cooking.
- Add seasoning after cooking.
- For faster cooking, it is recommended to cut into smaller, even sizes.
- Cook all fresh vegetables using full microwave power (850 W).

Food	Serving size (g)	Cooking time (min.)	Standing time (min.)
Broccoli	250	4-5	3
	500	5-6	
Prepare even sized florets. Arrange the stems to the centre			
Brussels sprouts	250	5-6	3
	500	7-8	
Add 60-75 ml (4-5 tbsp.) of water.			
Carrots	250	5-6	3
	Cut carrots into even sized slices.		
Cauliflower	250	5-6	3
	500	7-8	
Prepare even sized florets. Cut big florets into halves. Arrange stems to the centre.			
Courgettes	250	3-4	3
	Cut courgettes into slices. Add 30 ml (2 tbsp.) of water or a knob of butter. Cook until just tender.		
Egg Plants	250	3-4	3
	Cut egg plants into small slices and sprinkle with 1 tablespoon lemon juice.		
Leeks	250	3-4	3
	Cut leeks into thick slices.		

Cooking Smart

Food	Serving size (g)	Cooking time (min.)	Standing time (min.)
Mushrooms	125	1-2	3
	250	2-3	
Prepare small whole or sliced mushrooms. Do not add any water. Sprinkle with lemon juice. Spice with salt and pepper. Drain before serving.			
Onions	250	4-5	3
	Cut onions into slices or halves. Add only 15 ml (1 tbsp.) water.		
Peppers	250	4-5	3
	Cut pepper into small slices.		
Potatoes	250	4-5	3
	500	7-8	
	Weigh the peeled potatoes and cut them into similar sized halves or quarters.		
Turnip cabbage	250	5-6	3
	Cut turnip cabbage into small cubes.		

Rice and pasta

Stir from time to time during and after cooking.

Cook uncovered, and close the lid during settling. Then, drain water thoroughly.

- **Rice:** Use a large glass Pyrex container with a lid against the rice doubling in volume.
- **Pasta:** Use a large glass Pyrex container.

Food	Serving size (g)	Power (W)	Cooking time (min.)	Standing time (min.)	Directions
White rice (parboiled)	250	850	17-18	5	Add 500 ml of cold water.
	375		18-20		Add 750 ml of cold water.
Brown rice (parboiled)	250	850	20-22	5	Add 500 ml of cold water.
	375		22-24		Add 750 ml of cold water.
Mixed rice (rice + wild rice)	250	850	17-19	5	Add 500 ml of cold water.
Mixed corn (rice + grain)	250	850	18-20	5	Add 400 ml of cold water.
Pasta	250	850	10-11	5	Add 1000 ml of hot water.

Reheating

- Do not reheat large-sized foods such as joints of meat, which easily overcook.
- It is safer to reheat foods at lower power levels.
- Stir well or turn over during and after cooking.
- Use caution for liquids or baby foods. Stir well before, during, and after cooking with a plastic spoon or glass stirring stick to prevent eruptive boiling and scalding. Keep them inside the oven during the standing time. Allow a longer reheating time than other food types.
- Recommended standing time after reheating is 2-4 minutes. See the table below for reference.

Liquids and food

Food	Serving size	Power (W)	Cooking time (min.)	Standing time (min.)
Drink	250 ml (1 mug)	850	1½-2	1-2
	500 ml (2 mugs)		2-3	
Pour into a ceramic cup and reheat uncovered. Place cup in the center of ceramic tray. Stir carefully before and after standing time.				
Soup (Chilled)	250 g	850	3-4	2-3
	Pour into a deep ceramic plate. Cover with plastic lid. Stir well after reheating. Stir again before serving.			
Stew (Chilled)	350 g	600	5-6	2-3
	Pour into a deep ceramic plate. Cover with plastic lid. Stir well after reheating. Stir again before serving.			
Pasta with sauce (Chilled)	350 g	600	5-6	2-3
	Pour into a deep ceramic plate. Cover with plastic lid. Stir well after reheating. Stir again before serving.			
Plated meal (Chilled)	350 g	600	5-6	3
	450 g		6-7	
Plate a meal of 2-3 chilled components on a ceramic dish. Cover with microwave cling film.				

Baby foods & milk

Food	Serving size	Power (W)	Cooking time (sec.)	Standing time (min.)
Baby Food (Vegetable + Meat)	190 g	600	30-40	2-3
	Empty into ceramic deep plate. Cook covered. Stir after cooking time. Stand for 2-3 minutes. Before serving, stir well and check the temperature carefully.			
Baby Porridge (Grain + Milk + Fruit)	190 g	600	20-30	2-3
	Empty into ceramic deep plate. Cook covered. Stir after cooking time. Stand for 2-3 minutes. Before serving, stir well and check the temperature carefully.			
Baby Milk	100 ml	300	30-40	2-3
	200 ml		50-60	
Stir or Shake well and pour into a sterilized glass bottle. Place into the centre of ceramic tray. Cook uncovered. Shake well and stand for at least 3 minutes. Before serving, Shake well and check the temperature carefully.				

Defrost

Put frozen food in a microwave-safe container without a cover. Turn over during defrosting, and drain off liquid and remove giblets after defrosting. For faster defrosting, cut the food into small pieces, and wrap them with aluminum foil before defrosting. When the outer surface of frozen foods begins to melt, stop defrosting and let stand as instructed in the table below.

Do not change the default power level (180 W) for defrosting.

Place food on ceramic tray, and then insert ceramic tray in level 1.

Cooking Smart

Food		Serving size (g)	Defrosting time (min.)	Standing time (min.)
Meat	Minced meat	250	6-7	15-30
	Pork steaks	500	8-12	
Place the meat on the ceramic plate. Shield thinner edges with aluminium foil. Turn over after half of defrosting time.				
Poultry	Chicken pieces	500 (2 pcs.)	12-14	15-60
	Whole chicken	1200	28-32	
First, put chicken pieces skin-side down, whole chicken breast-side-down on ceramic plate. Shield the thinner parts like wings and ends with aluminium foil. Turn over after half of defrosting time.				
Fish	Fish fillets	200	6-7	10-25
	Whole fish	400	11-13	
Put frozen fish in the middle of ceramic plate. Arrange the thinner parts under the thicker parts. Shield narrow ends of fillets and tail of whole fish with aluminium foil. Turn over after half of defrosting time.				
Fruit	Berries	300	6-7	5-10
	Spread fruit on a flat, round glass dish with a large diameter.			
Bread	Bread rolls (each ca. 50 g)	2 pcs	1-1½	5-20
		4 pcs	2½-3	
	Toast/sandwich	250	4-4½	
		500	7-9	
Arrange rolls in a circle or bread horizontally on kitchen paper on the ceramic plate. Turn over after half of defrosting time.				

Convection guide

Convection

Use temperatures and times in this table as guidelines for baking. We recommend to preheat the oven with Convection mode.

Food	Temp. (°C)	Accessory	Level	Cooking time (min.)
Hazelnut cake square mould	160-170	Oven rack	2	60-70
Lemon cake ring-shaped or bowl mould	150-160	Oven rack	2	50-60
Sponge cake	150-160	Oven rack	2	25-35
Fruit flan base	150-170	Oven rack	2	25-35
Flat streusel fruit cake (yeast dough)	150-170	Baking tray	3	30-40
Croissants	170-180	Baking tray	2	10-15
Bread rolls	180-190	Baking tray	2	10-15
Cookies	160-180	Baking tray	3	10-20
Oven chips	200-220	Baking tray	3	15-20

Top Heat + Convection

Use temperatures and times in this table as guidelines for roasting.

We recommend to preheat the oven using Top Heat + Convection mode.

Put meat on oven rack, follow shelf level advice in the table and use baking tray as oil pan on level 2.

Food	Temp. (°C)	Accessory	Level	Cooking time (min.)
Beef roast beef (1 kg / medium)	170-190	Oven rack + Baking tray	3+2	60-90
Pork shoulder joint / Roll (1 kg)	180-200	Oven rack + Baking tray	3+2	90-120
Lamb roast lamb / Leg of lamb (0.8 kg)	190-210	Oven rack + Baking tray	3+2	50-80
Chicken whole chicken (1.2 kg)	200-220	Oven rack + Baking tray	3+2	50-70
Fish whole trouts (2 pcs / 0.5 kg)	180-200	Oven rack + Baking tray	3+2	30-40
Duck breast (0.3 kg)	180-200	Oven rack + Baking tray	3+2	25-35

Bottom Heat + Convection

Use temperatures and times in this table as guidelines for baking.

We recommend to preheat the oven with Bottom Heat + Convection mode.

Food	Temp. (°C)	Accessory	Level	Cooking time (min.)
Homemade pizza	180-200	Baking tray	1	20-30
Chilled pre-baked quiche / Pie	180-200	Oven rack	2	10-15
Frozen self rising pizza	180-200	Baking tray	2	15-20
Frozen pizza	180-200	Baking tray	2	15-25
Chilled pizza	180-200	Baking tray	2	8-15
Apple pie	160-180	Oven rack	1	60-70
Puff pastry, apple filling	180-200	Baking tray	2	10-15

Cooking Smart

Grilling guide

Large Grill

Use temperatures and times in this table as guidelines for grilling.
Set 220 °C grill temperature, preheat for 5 minutes.

Food	Accessory	Level	Cooking time 1st side (min.)	Cooking time 2nd side (min.)
Kebab spits	Oven rack + Baking tray	5+2	8-10	6-8
Pork steaks	Oven rack + Baking tray	5+2	7-9	5-7
Sausages	Oven rack	5+2	6-8	6-8
Chicken pieces	Oven rack + Baking tray	5+2	20-25	15-20
Salmon steaks	Oven rack + Baking tray	5+2	8-12	6-10
Sliced vegetables	Baking tray	5	15-20	-
Toast	Oven rack	5	2-3	1-2
Cheese toasts	Oven rack	5	3-5	-

Fan Grill

Use temperatures and times in this table as guidelines for grilling.
Set 220 °C grill temperature, preheat for 5 minutes.

Food	Accessory	Level	Cooking time (min.)
Sausages	Oven rack	4	8-10
Potato wedges	Oven rack	4	20-25
Frozen oven chips	Baking tray	4	15-20
Frozen croquettes	Baking tray	4	20-25
Frozen nuggets	Baking tray	4	15-20
Salmon steak	Oven rack + Baking tray	4+2	15-20
Fish fillet	Oven rack + Baking tray	4+2	12-17
Whole fish	Oven rack + Baking tray	4+2	15-20
Chicken pieces	Oven rack + Baking tray	4+2	30-40

Combination cooking guide

- Do not use metal containers with Microwave mode. Always put food containers on the cavity.
- It is recommended to cover the food for best results.
- After cooking is complete, let the food settle in its own steam.

Microwave + Grill

Use power level with temperatures and times in this table as guidelines for cooking. Preheating is not needed.

Food	Power level (W)	Temp. (°C)	Accessory	Level	Cooking time 1st side (min.)	Cooking time 2nd side (min.)
Baked potatoes	600	180-200	Ceramic tray+ Grill insert	4	10-15	-
Grilled tomatoes	300	160-180	Ceramic tray+ Grill insert	4	05-10	-
Vegetable gratin	450	180-200	Ceramic tray+ Grill insert	4	10-20	-
Roast fish	300	180-200	Ceramic tray+ Grill insert	4	04-08	04-06
Chicken pieces	300	180-200	Ceramic tray+ Grill insert	4	10-15	10-15

Microwave + Convection

Use power level with temperatures and times in this table as guidelines for cooking. Preheating is not needed.

Food	Power level (W)	Temp. (°C)	Accessory	Level	Cooking time 1st side (min.)	Cooking time 2nd side (min.)
Whole chicken (1.2 kg)	450	180-200	Ceramic tray + Grill insert	3	25-30	15-25
Roast beef / Lamb (Medium)	300	180-200	Ceramic tray + Grill insert	3	15-20	15-20
Frozen lasagne / Pasta gratin	450	180-200	Ceramic tray + Grill insert	3	20-25	-
Potato gratin	450	180-200	Ceramic tray + Grill insert	3	10-15	-
Fresh fruit flan	100	160-180	Ceramic tray	3	40-50	-

Cooking Smart

Microwave + Roast

Use power level with temperatures and times in this table as guidelines for cooking. Preheating is not needed.

Food	Power level (W)	Temp. (°C)	Accessory	Level	Cooking time (min.)
Chicken pieces	300	180-200	Ceramic tray + Grill insert	4	20-30
Potato wedges	300	180-200	Ceramic tray + Grill insert	4	15-20
Whole fish	300	180-200	Ceramic tray + Grill insert	4	15-20
Fish fillet	300	180-200	Ceramic tray + Grill insert	4	10-15
Frozen nuggets	450	180-200	Ceramic tray + Grill insert	4	10-15
Frozen spring rolls	300	180-200	Ceramic tray + Grill insert	4	05-10
Frozen fish finger	300	180-200	Ceramic tray + Grill insert	4	15-20

Pro Steamer

The cooking time depends on size, thickness and type of food. When steaming thin slices or small pieces we recommend to reduce the time. When steaming thick slices or big sized pieces of food you can add time. Use the power levels and times in this table as a guide lines for steam cooking.

Food	portion (g)	Cold water (ml)	Power (W)	Time (min)	Instruction
Broccoli florets	400	500	850	12-18	Rinse and clean broccoli. Cut into similar sized florets. Put florets evenly on steam tray.
Carrots	400	500	850	15-20	Rinse and clean carrots and cut into even slices. Distribute slices on steam tray.
Cauliflower whole	600	500	850	20-25	Clean whole cauliflower and set on steam tray.
Corn on the cob	400 (2 pcs)	500	850	23-28	Rinse and clean corn on the cobs. Put corn on the cobs side by side on steam tray.
Courgettes	400	500	850	15-20	Rinse courgettes and cut them into similar slices. Distribute evenly on steam tray.
Frozen mixed vegetables	400	500	850	18-22	Distribute frozen mixed vegetables (-18 °C) e.g. broccoli, cauliflower, sliced carrots evenly on steam tray.
Potatoes (Small)	500	500	850	25-30	Rinse and clean potatoes and pierce skin with a fork. Set whole potatoes evenly on steam tray.

Food	portion (g)	Cold water (ml)	Power (W)	Time (min)	Instruction
Apples	800 (8 apples)	500	850	15-20	Rinse and core apples. Put apples upright side by side on steam tray.
Eggs	4-6 eggs	500	850	15-20	Pierce 4-6 fresh eggs (size M) and set them in the small cavities of steam tray. After steaming keep standing covered for 2-5 minutes.
Blue prawns	250 (5-6 pcs)	500	850	10-15	Sprinkle blue prawns with 1-2 tablespoons lemon juice. Put them evenly on steam tray.
Fish fillets (Cod fish, Rose-fish)	500 (2-3 pcs)	500	850	15-20	Sprinkle fish fillets with 1-2 tablespoons lemon juice and add herbs and spices (e.g. rosemary). Put fillets evenly on steam tray.
Chicken breast fillets	400 (2 fillets)	500	850	20-25	Rinse and clean the chicken breast fillets. Put chicken breast fillets side by side on steam tray.

NOTE

How to clean the Pro Steamer.

- Clean the Pro Steamer with warm water and detergent and rinse off with clean water.
- Do not use a scrubbing brush or a hard sponge otherwise the top layer will be damaged.
- The Pro Steamer is not dishwasher-safe.

Fan Conventional guide

Use temperatures and times in this table as guidelines for baking. We recommend to preheat the oven with Fan Conventional mode.

Food	Temp. (°C)	Accessory	Level	Cooking time (min.)
Lasagne	200-220	Oven rack	3	20-25
Vegetables gratin	180-200	Oven rack	3	20-30
Potato gratin	180-200	Oven rack	3	40-60
Frozen pizza baguettes	160-180	Baking tray	3	10-15
Marble cake	160-180	Oven rack	2	50-70
Loaf cake	150-170	Oven rack	2	50-60
Muffins	180-200	Oven rack	2	20-30
Cookies	180-200	Baking tray	3	10-20

Intensive Cook guide

Use temperatures and times in this table as guidelines for roasting. We recommend to preheat the oven with Intensive (Top + Bottom + Convection) mode.

Food	Temp. (°C)	Accessory	Level	Cooking time (min.)
Lasagne (2 kg)	180-200	Oven rack	2	20-30
Vegetables gratin (2 kg)	160-180	Oven rack	2	40-60
Potato gratin (2 kg)	160-180	Oven rack	2	60-90
Roast beef (2 kg)	160-180	Oven rack + Baking tray	3+2	60-90
Whole duck (2 kg)	180-200	Oven rack + Baking tray	3+2	60-90
2 Whole chicken (1.2 kg each)	200-220	Oven rack + Baking tray	3+2	60-90

Cooking Smart

Pro-Roasting

This mode includes an automatic heating-up cycle over 200 °C. The top heater and the convection fan is operating during the process of searing the meat. After this stage the food is cooked gently by the low temperature of pre-selection.

This process is done while the top and the bottom heaters are operating.

This mode is suitable for meat roasts, poultry and fish.

Use temperatures and times in this table as guidelines for roasting.

Food	Temp. (°C)	Accessory	Level	Cooking time (hrs.)
Roast beef	80-100	Oven rack + Baking tray	3+2	3:30-4:30
Roast pork	80-110	Oven rack + Baking tray	3+2	3:30-4:00
Duck breast	80-100	Oven rack + Baking tray	3+2	1:30-2:00
Fillet of beef	80-110	Oven rack + Baking tray	3+2	1:30-2:00
Pork fillet	80-110	Oven rack + Baking tray	3+2	1:30-2:00

Air Fry

Use temperatures and times in this table as guidelines for air frying.

No preheating is required.

Food	Serving size(g)	Temp. (°C)	Level	Cooking time (min.)
Potatoes				
Frozen Oven Chips	500-1000	210-220	4	20-25
Frozen Oven Chips, Seasoned	500-1000	210-220	4	15-20
Frozen Tater Tots	500-1000	210-220	4	15-20
Frozen Hash Brown*	500-1000	210-220	4	15-20
Frozen Potato Wedges	500-1000	210-220	4	15-20
Homemade Oven Chips	500-1000	190-200	4	20-25
Homemade Potato Wedges*	500-1000	200-210	4	20-25
Frozen				
Frozen Chicken Nuggets	300-500	210-220	4	15-20
Frozen Chicken Wings*	500-1000	210-220	4	25-30
Frozen Onion Rings	300-500	210-220	4	10-15
Frozen Fish Fingers	300-500	210-220	4	15-20
Frozen Chicken Strips	500-1000	210-220	4	20-25
Frozen Churros	300-500	190-200	4	10-15
Poultry				
Fresh Drumsticks*	500-1000	200-210	4	30-35
Fresh Chicken Wings*	300-500	200-210	4	27-32
Chicken Breasts, Breaded*	300-500	200-210	4	25-30

Food	Serving size(g)	Temp. (°C)	Level	Cooking time (min.)
Vegetables				
Asparagus, Breaded	100-300	200	4	15-20
Egg Plants, Breaded	200-400	200	4	15-20
Mushroom, Breaded	100-300	200	4	15-20
Onions, Breaded	100-300	200	4	15-20
Cauliflowers, Breaded	300-500	190-200	4	15-20
Vegetable Mix, Breaded	300-500	200	4	15-20

* Turnover after 2/3 of the cooking time.

 **NOTE**

- Place a baking sheet or tray on the rack below the Air fry tray for getting any drippings. This will help to reduce splatter and smoke.
- Before using a baking sheet, check the maximum allowable temperature of baking sheet.
- For cooking fresh or homemade foods, spread the oil over a larger area more evenly, crisping up the food more effectively.

Multi-level Cook (Special)

Use temperatures and times in this table as guidelines for baking. We recommend to preheat the oven with Multi-level Cook mode.

Food	Temp. (°C)	Accessory	Level	Cooking time (min.)
Small cakes	150-160	2 baking trays	2+4	20-30
Mini pies	160-180	2 baking trays	2+4	20-30
Croissants	160-180	2 baking trays	2+4	20-30
Puff pastry	180-200	2 baking trays	2+4	30-40
Cookies	170-190	2 baking trays	2+4	15-20
Lasagne	160-180	Oven rack + Baking Tray	2+4	30-45
Frozen oven chips	180-200	2 baking trays	2+4	30-50
Frozen nuggets	180-200	2 baking trays	2+4	20-30
Frozen pizza	200-220	Oven rack + Baking Tray	2+4	20-30

Cooking Smart

Quick & Easy

Melting butter

Put 50 g butter into a small deep glass dish. Cover with plastic lid. Heat for 30-40 seconds using 850 W, until butter is melted.

Melting chocolate

Put 100 g chocolate into a small deep glass dish. Heat for 3-5 minutes, using 450 W until chocolate is melted. Stir once or twice during melting. Use oven gloves while taking out!

Melting crystallized honey

Put 20 g crystallized honey into a small deep glass dish. Heat for 20-30 seconds using 300 W, until honey is melted.

Melting gelatine

Lay dry gelatine sheets (10 g) for 5 minutes into cold water. Put drained gelatine into a small glass pyrex bowl. Heat for 1 minute using 300 W. Stir after melting.

Cooking glaze/icing (for cake and gateaux)

Mix instant glaze (approximately 14 g) with 40 g sugar and 250 ml cold water. Cook uncovered in a glass pyrex bowl for 3½ to 4½ minutes using 850 W, until glaze/icing is transparent. Stir twice during cooking.

Cooking jam

Put 600 g fruits (for example mixed berries) in a suitable sized glass pyrex bowl with lid. Add 300 g preserving sugar and stir well. Cook covered for 10-12 minutes using 850 W. Stir several times during cooking. Put directly into small jam glasses with twist-off lids. Stand on lid for 5 minutes.

Cooking pudding

Mix pudding powder with sugar and milk (500 ml) by following the manufacturers instructions and stir well. Use a suitable sized glass pyrex bowl with lid. Cook covered for 6½ to 7½ minutes using 850 W. Stir several times well during cooking.

Browning almond slices

Spread 30 g sliced almonds evenly on a medium sized ceramic plate. Stir several times during browning for 3½ to 4½ minutes using 600 W. Let it stand for 2-3 minutes in the oven. Use oven gloves while taking out!

Maintenance

Cleaning

Clean the oven regularly to prevent impurities from building up on or inside the oven. Also pay special attention to the door and door sealing (applicable models only).

If the door won't open or close smoothly, first check if the door seals have built up impurities. Use a soft cloth in soapy water to clean both the inner and outer sides of the oven. Rinse and dry well.

If there are fingerprints, grease, or stains on the exterior (such as the door surface, handle, or display), clean with a soft cloth with a glass cleaner or neutral detergent, and then wipe dry with a soft, clean, dry cloth.

To remove stubborn impurities with bad smells from inside the oven

1. With an empty oven, put a cup of diluted lemon juice on the centre of the cavity.
2. Heat the oven for 10 minutes at maximum temperature of oven mode.
3. When the cycle is complete, wait until the oven cools down. Then, open the door and clean the cooking chamber.

⚠ CAUTION

- Keep the door and door sealing clean and ensure the door opens and closes smoothly. Otherwise, the oven's lifecycle may be shortened.
- Take caution not to spill water into the oven vents.
- Do not use any abrasive or chemical substances for cleaning.
- After each use of the oven, use a mild detergent to clean the cooking chamber after waiting for the oven to cool down.

Side racks (applicable models only)

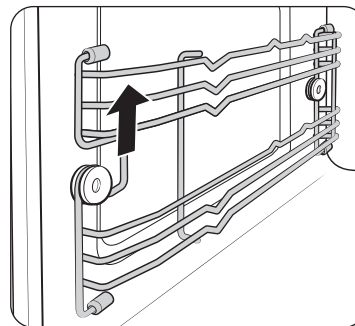

1. Lift up the front of the rack to release it from the holder.

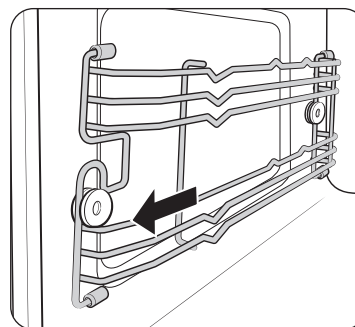

2. Pull the rack forward to remove it.
3. Remove the other side rack in the same way.
4. Clean both side racks.
5. When done, follow steps 1 to 2 in reverse order to assemble them.

📖 NOTE

The oven operates without the side racks and racks in position.

Maintenance

Replacement (repair)

WARNING

This oven has no user-removable parts inside. Do not try to replace or repair the oven yourself.

- If you encounter a problem with hinges, sealing, and/or the door, contact a qualified technician or a local Samsung service centre for technical assistance.
- If you want to replace the light bulb, contact a local Samsung service centre. Do not replace it yourself.
- If you encounter a problem with the outer housing of the oven, first unplug the power cord from the power source, and then contact a local Samsung service centre.

Care against an extended period of disuse

If you don't use the oven for an extended period of time, unplug the power cord and move the oven to a dry, dust-free location. Dust and moisture that builds up inside the oven may affect the performance of the oven.

Troubleshooting

You may encounter a problem using the oven. In that case, first check the table below and try the suggestions. If a problem persists, or if any information code keeps appearing on the display, contact a local Samsung service centre.

Checkpoints

If you encounter a problem with the oven, first check the table below and try the suggestions.

Problem	Cause	Action
General		
The buttons cannot be pressed properly.	Foreign matter may be caught between the buttons.	Remove the foreign matter and try again.
	For touch models: Moisture is on the exterior.	Wipe the moisture from the exterior.
	Child lock is activated.	Deactivate Child lock.
The time is not displayed.	Power is not supplied.	Make sure power is supplied.
	The display option is off.	Turn the display option on. It is normal for the current time to disappear a few minutes after the display option has been turned on.

Problem	Cause	Action
The oven does not work.	Power is not supplied.	Make sure power is supplied.
	The door is open.	Close the door and try again.
	The door open safety mechanisms are covered in foreign matter.	Remove the foreign matter and try again.
The oven stops while in operation.	The user has opened the door to turn food over.	After turning the food over, select Continue, and then press the Dial Knob.
The power turns off during operation.	The oven has been cooking for an extended period of time.	After cooking for an extended period of time, let the oven cool.
	The cooling fan is not working.	Listen for the sound of the cooling fan.
	Trying to operate the oven without food inside.	Put food in the oven.
	There is not sufficient ventilation space for the oven.	There are intake/exhaust outlets on the front and rear of the oven for ventilation. Keep the gaps specified in the product installation guide.
	Several power plugs are being used in the same socket.	Designate only one socket to be used for the oven.
There is no power to the oven.	Power is not supplied.	Make sure power is supplied.

Problem	Cause	Action
There is a popping sound during operation, and the oven doesn't work.	Cooking sealed food or using a container with a lid may causes popping sounds.	Do not use sealed containers as they may burst during cooking due to expansion of the contents.
The oven exterior is too hot during operation.	There is not sufficient ventilation space for the oven.	There are intake/exhaust outlets on the front and rear of the oven for ventilation. Keep the gaps specified in the product installation guide.
	Objects are on top of the oven.	Remove all objects on the top of the oven.
The door cannot be opened properly.	Food residue is stuck between the door and oven interior.	Clean the oven and then open the door.
The oven does not heat.	The oven may not work, too much food is being cooked, or improper cookware is being used.	Put one cup of water in a microwave-safe container and run the microwave for 1-2 minutes to check whether the water is heated. Reduce the amount of food and start the function again. Use a cooking container with a flat bottom.

Troubleshooting

Problem	Cause	Action
Heating is weak or slow.	The oven may not work, too much food is being cooked, or improper cookware is being used.	Put one cup of water in a microwave-safe container and run the microwave for 1-2 minutes to check whether the water is heated. Reduce the amount of food and start the function again. Use a cooking container with a flat bottom.
The warm function does not work.	The oven may not work, too much food is being cooked, or improper cookware is being used.	Put one cup of water in a microwave-safe container and run the microwave for 1-2 minutes to check whether the water is heated. Reduce the amount of food and start the function again. Use a cooking container with a flat bottom.

Problem	Cause	Action
The thaw function does not work.	The oven may not work, too much food is being cooked, or improper cookware is being used.	Put one cup of water in a microwave-safe container and run the microwave for 1-2 minutes to check whether the water is heated. Reduce the amount of food and start the function again. Use a cooking container with a flat bottom.
The interior light is dim or does not turn on.	The door has been left open for a long time.	The interior light may automatically turn off when the door stays open for a long time. Close and reopen the door or press the "Light" button.
	The interior light is covered by foreign matter.	Clean the inside of the oven and check again.
A beeping sound occurs during cooking.	If the Auto Cook or Auto Defrost function is used, this beeping sound means it is time to turn the food over during thawing.	Turn the food over when the notification pops up, select OK, and then press the Dial Knob. Then, select Continue, and then press the Dial Knob to resume process.
The oven is not level.	The oven is installed on an uneven surface.	Make sure the oven is installed on flat, stable surface.

Problem	Cause	Action
There are sparks during cooking.	Metal containers are used during the oven/thawing functions.	Do not use metal containers.
When power is connected, the oven immediately starts to work.	The door is not properly closed.	Close the door and check again.
There is electricity coming from the oven.	The power or power socket is not properly grounded.	Make sure the power and power socket are properly grounded.
There is water dripping.	There may be water or steam in some cases depending on the food. This is not an oven malfunction.	Let the oven cool and then wipe with a dry dish towel.
Steam leaks from the door.	There may be water or steam in some cases depending on the food. This is not an oven malfunction.	Let the oven cool and then wipe with a dry dish towel.
There is water left in the oven.	There may be water or steam in some cases depending on the food. This is not an oven malfunction.	Let the oven cool and then wipe with a dry dish towel.
The brightness inside the oven varies.	Brightness changes depending on power output changes according to function.	Power output changes during cooking are not malfunctions. This is not an oven malfunction.

Problem	Cause	Action
Cooking is finished, but the cooling fan is still running.	To ventilate the oven, the cooling fan continues to run for about 5 minutes after cooking is complete.	This is not an oven malfunction.
Pressing the +30 secs button operates the oven.	This happens when the oven was not operating.	The microwave oven is designed to operate by pressing the +30 secs button when it was not operating.
Grill		
Smoke comes out during operation.	During initial operation, smoke may come from the heating elements when you first use the oven.	This is not a malfunction, and if you run the oven 2-3 times, it should stop.
	Food is on the heating elements.	Let the oven cool and then remove the food from the heating elements.
	Food is too close to the grill.	Put the food a suitable distance away while cooking.
	Food is not properly prepared and/or arranged.	Make sure food is properly prepared and arranged.

Troubleshooting

Problem	Cause	Action
Oven		
The oven does not heat.	The door is open.	Close the door and try again.
Smoke comes out during preheating.	During initial operation, smoke may come from the heating elements when you first use the oven.	This is not a malfunction, and if you run the oven 2-3 times, it should stop.
	Food is on the heating elements.	Let the oven cool and then remove the food from the heating elements.
There is a burning or plastic smell when using the oven.	Plastic or non heat-resistant cookware is used.	Use glass cookware suitable for high temperatures.
There is a bad smell coming from inside the oven.	Food residue or plastic has melted and stuck to the interior.	Use the Steam function and then wipe with a dry cloth. You can put a lemon slice inside and run the oven to remove the odour more quickly.

Problem	Cause	Action
The oven does not cook properly.	The oven door is frequently opened during cooking.	Do not frequently open the door unless you are cooking things that need to be turned. If you open the door often, the interior temperature will be lowered and this may affect the results of your cooking.
	The oven controls are not correctly set.	Correctly set the oven controls and try again.
	The grill or other accessories are not correctly inserted.	Correctly insert the accessories.
	The wrong type or size of cookware is used.	Reset the oven controls or use suitable cookware with flat bottoms.

Information codes

If the oven fails to operate, you may see an information code on the display. Check the table below and try the suggestions.

Code	Description	Action
C-20	The temperature sensor is open.	Unplug the power cord of the oven, and contact a local Samsung service centre.
	The temperature sensor is short.	
C-F0	If there is no communication between the main and sub MICOM.	
C-F1	Only occurs when EEPROM Read or Write is not working.	
C-21	This code appears when the oven temperature high. In case the temperature rises over the limit temperature during operation of each mode. (Fire sensed.)	Unplug the power cord for cooling enough time, and restart the microwave oven.
C-F2	The touch key is malfunction.	Stop the oven and then try again.
C-d0		Unplug the power cord for cooling enough time, and clean the button. (Dust, Water) When appear same problem, contact a local Samsung service centre.

Technical specifications

SAMSUNG strives to improve its products at all times. Both the design specifications and these user instructions are thus subject to change without notice.

Power Source		230 V ~ 50 Hz
Power Consumption	Maximum power	2800 W
	Microwave	1650 W
	Grill	2550 W
	Convection	2500 W
Output Power		100 W / 850 W (IEC-705) 240 V: 850 W 230 V: 800 W
Operating Frequency		2450 MHz
Magnetron		OM75P (21)
Cooling Method		Cooling fan motor
Dimensions (W x H x D)	Main unit	595 X 456 X 570 mm
	Built-in	560 X 446 X 549 mm
Volume		50 liter
Weight	Net	39.9 Kg
	Shipping	48.8 Kg

* This product contains a light source of energy efficiency class <G>.

Appendix

Overall Standby Power consumption (W) (All network ports is "on" condition)		1.9 W
Period of time for the power management (min)		20 min.
WiFi	Standby-mode Power Consumption (W)	1.9 W
	Period of time for the power management (min)	20 min.
Off mode	Power consumption	0.5 W
	Period of time for the power management (min)	30 min.

Data determined according to standard EN 50564 and Regulation (EC) No 1275/2008.

NOTE

Hereby, Samsung declares that this radio equipment is in compliance with Directive 2014/53/EU and with the relevant statutory requirements in the UK. The full text of the EU declaration of conformity and the UK declaration of conformity is available at the following internet address: The official Declaration of conformity may be found at <http://www.samsung.com>. go to Support > Search Product Support and enter the model name.

CAUTION

The 5 GHz WLAN function of this equipment may only be operated indoors in all EU countries and in the UK.

	Frequency range	Transmitter power (Max)
Wi-Fi	2400-2484 MHz	20 dBm
	5150-5250 MHz	23 dBm
	5250-5350 MHz	23 dBm
	5470-5725 MHz	23 dBm

Open Source Announcement

The software included in this product contains open source software. You may obtain the complete corresponding source code for a period of three years after the last shipment of this product by contacting our support team via <http://opensource.samsung.com> (Please use the "Inquiry" menu.)

It is also possible to obtain the complete corresponding source code in a physical medium such as a CD-ROM; a minimal charge will be required.

The following URL http://opensource.samsung.com/opensource/COMMON_R18_TZ4_0/seq/0 leads to the open source license information as related to this product. This offer is valid to anyone in receipt of this information.



Memo

Please be advised that the Samsung warranty does NOT cover service calls to explain product operation, correct improper installation, or perform normal cleaning or maintenance.

QUESTIONS OR COMMENTS?

COUNTRY	CALL	OR VISIT US ONLINE AT
AUSTRIA	0800 72 67 864 (0800-SAMSUNG)	www.samsung.com/at/support
BELGIUM	02-201-24-18	www.samsung.com/be/support (Dutch) www.samsung.com/be_fr/support (French)
DENMARK	707 019 70	www.samsung.com/dk/support
FINLAND	030-6227 515	www.samsung.com/fi/support
FRANCE	01 48 63 00 00	www.samsung.com/fr/support
GERMANY	06196 77 555 77	www.samsung.com/de/support
ITALIA	800-SAMSUNG (800.7267864)	www.samsung.com/it/support
CYPRUS	8009 4000 only from landline, toll free	www.samsung.com/gr/support
GREECE	80111-SAMSUNG (80111 726 7864) only from land line (+30) 210 6897691 from mobile and land line	www.samsung.com/gr/support
LUXEMBURG	261 03 710	www.samsung.com/be_fr/support
NETHERLANDS	088 90 90 100	www.samsung.com/nl/support
NORWAY	21629099	www.samsung.com/no/support
PORTUGAL	210 608 098 Chamada para a rede fixa nacional Dias úteis das 9h às 20h	www.samsung.com/pt/support
SPAIN	91 175 00 15	www.samsung.com/es/support
SWEDEN	0771-400 300	www.samsung.com/se/support
SWITZERLAND	0800 726 786	www.samsung.com/ch/support (German) www.samsung.com/ch_fr/support (French)
UK	0333 000 0333	www.samsung.com/uk/support
IRELAND (EIRE)	0818 717100	www.samsung.com/ie/support

