

Induction Hob

User manual

NZ64B6056** / NZ64B6058**

NZ63B6056** / NZ63B6058**



SAMSUNG

Contents

Using this manual **3**

The following symbols are used in this User Manual:	3
Model name & serial number	3

Safety instructions **3**

Disposing of the packaging material	7
Proper disposal of your old appliance	7
Correct Disposal of This Product (Waste Electrical & Electronic Equipment)	7

Installing the hob **8**

Safety instructions for the installer	8
Tools you will need	8
Connecting to the mains power supply	8
Installing into the countertop	9
Components	11

Before you start **11**

Cooking zones	11
Control panel	12
Induction heating	13
Safety shutoff	13
Residual heat indicator	14
Temperature detection	14
Cookware	14
Using the touch buttons	18
Operating noises	18
Initial cleaning	18

Operation **18**

Switching the appliance on	18
Switching the appliance off	18
Selecting cooking zone and power level	19
Max Boost	20

Using the Flex zone (Only for Flex zone applied models)	20
Flex zone Plus (Only for Flex zone plus applied models)	21
Keep Warm	22
Timer	22
Pause/Resume	22
Quick stop	22
Child safety lock	23
Maximum power limit	23
Sound on/off	24
Smart Connect	24
Hood control	25

Maintaining your appliance **25**

Hob	25
Light soiling	25
Stubborn soiling	26
Problem dirt	26
Hob frame (option)	27
To avoid damaging your appliance	27

Troubleshooting and service **27**

Troubleshooting	27
Service	29

Using this manual

Please take the time to read this owner's manual, paying particular attention to the safety information contained in the following section, before using your appliance.

Keep this manual for future reference.

If transferring ownership of the appliance, please remember to pass the manual on to the new owner.

The following symbols are used in this User Manual:

WARNING

Hazards or unsafe practices that may result in **severe personal injury or death**.

CAUTION

Hazards or unsafe practices that may result in **minor personal injury or property damage**.

CAUTION

To reduce the risk of fire, explosion, electric shock, or personal injury when using your hob, follow these basic safety precaution.

NOTE

Useful tips, recommendations, or information that helps users manipulate the product.

Model name & serial number

Both the model name and the serial number are labeled underneath the hob base.

For later use, write down the information or attach the additional product label (located on the top of the product) onto the current page.

Model Name _____

Serial Number _____

Safety instructions

The safety aspects of this appliance comply with all accepted technical and safety standards. However, as manufacturers we also believe it is our responsibility to familiarize you with the following safety instructions.

WARNING

This appliance is not intended for use by persons (including children) with reduced physical, sensory or mental capabilities, or lack of experience and knowledge, unless they have been given supervision or instruction concerning use of the appliance by a person responsible for their safety.

Children should be supervised to ensure that they do not play with the appliance.

This appliance can be used by children aged from 8 years and above and persons with reduced physical, sensory or mental capabilities or lack of experience and knowledge if they have been given supervision or instruction concerning use of the appliance in a safe way and understand the hazards involved. Children shall not play with the appliance. Cleaning and user maintenance shall not be made by children without supervision. The means for disconnection must be incorporated in the fixed wiring in accordance with the wiring rules.

Safety instructions

This Appliance should be allowed to disconnection from the supply after installation. The disconnection may be achieved by having the plug accessible or by incorporating a switch in the fixed wiring in accordance with the wiring rules.

If the supply cord is damaged, it must be replaced by the manufacturer, its service agent or similarly qualified persons in order to avoid a hazard.

The method of fixing stated is not to depend on the use of adhesives since they are not considered to be a reliable fixing means.

WARNING: If the surface is cracked, switch off the appliance to avoid the possibility of electric shock.

During use the appliance becomes hot. Care should be taken to avoid touching heating elements inside the hob.

WARNING: Accessible parts may become hot during use. Young children should be kept away.

A steam cleaner is not to be used.

Metallic objects such as knives, forks, spoons and lids should not be placed on the hob surface since they can get hot.

After use, switch off the hob element by its control and do not rely on the pan detector.

The appliance is not intended to be operated by means of an external timer or separate remote-control system.

CAUTION: The cooking process has to be supervised. A short term cooking process has to be supervised continuously.

The appliance must not be installed behind a decorative door in order to avoid overheating.

WARNING: The appliance and its accessible parts become hot during use. Care should be taken to avoid touching heating elements. Children less than 8 years of age shall be kept away unless continuously supervised.

WARNING: Unattended cooking on a hob with fat or oil can be dangerous and may result in a fire.

NEVER try to extinguish a fire with water, but switch off the appliance and then cover flame e.g. with a lid or a fire blanket.

WARNING: Danger of fire: Do not store items on the cooking surfaces.

WARNING: Use only hob guards designed by the manufacturer of the cooking appliance or indicated by the manufacturer of the appliance in the instructions for use as suitable or hob guards incorporated in the appliance. The use of inappropriate guards can cause accidents.

The surfaces are liable to get hot during use.

This appliance can be used by children aged from 8 years and above and persons with reduced physical, sensory or mental capabilities or lack of experience and knowledge if they have been given supervision or instruction concerning use of the appliance in a safe way and understand the hazards involved. Children shall not play with the appliance. Cleaning and user maintenance shall not be made by children unless they are older than 8 and supervised.

Keep the appliance and its cord out of reach of children less than 8 years.

CAUTION

Be sure the appliance is properly installed and grounded by a qualified technician.

The appliance should be serviced only by qualified service personnel. Repairs carried out by unqualified individuals may cause injury or serious malfunction. If your appliance is in need of repair, contact your local service centre. Failure to follow these instructions may result in damage and void the warranty. Flush - mounted appliances may be operated only after they have been installed in cabinets and workplaces that conform to the relevant standards. This ensures sufficient protection against contact for electrical units as required by the essential safety standards.

If your appliance malfunctions or if fractures, cracks or splits appear:

- switch off all cooking zones;
- disconnect the hob from the mains supply; and
- contact your local service centre.

If the hob cracks, turn the appliance off to avoid the possibility of electric shock. Do not use your hob until the glass surface has been replaced.

Safety instructions

Do not use the hob to heat aluminium foil, products wrapped in aluminium foil or frozen foods packaged in aluminium cookware.

Liquid between the bottom of the pan and the hob can produce steam pressure. Which may cause the pan to jump.

Always ensure that the hotplate and the base of the pan are kept dry.

The cooking zones will become hot when you cook.

Always keep small children away from the appliance.

Keep all packaging materials well out of the reach of children, as packaging materials can be dangerous to children.

This appliance is to be used only for normal cooking and frying in the home. It is not designed for commercial or industrial use.

Never use the hob for heating the room.

Take care when plugging electrical appliances into mains sockets near the hob. Mains leads must not come into contact with the hob.

Overheated fat and oil can catch fire quickly. Never leave surface units unattended when preparing foods in fat or oil, for example, when cooking chips.

Turn the cooking zones off after use.

Always keep the control panels clean and dry.

Never place combustible items on the hob, it may cause fire.

There is the risk of burns from the appliance if used carelessly.

Cables from electrical appliances must not touch the hot surface of the hob or hot cookware.

Do not use the hob to dry clothes.

Users with Pacemakers and Active Heart Implants must keep their upper body at a minimum distance of 30 cm from induction cooking zones when turned on. If in doubt, you should consult the manufacturer of your device or your doctor. (Induction hob model only)

Do not attempt to repair, disassemble, or modify the appliance yourself.

Always turn the appliance off before cleaning.

Clean the hob in accordance with the cleaning and care instructions contained in this manual.

Keep pets away from the appliance because pets may step on the controls of the appliance, causing an malfunction.

Disposing of the packaging material

⚠ WARNING

All materials used to package the appliance are fully recyclable. Sheet and hard foam parts are appropriately marked. Please dispose of packaging materials and old appliances with due regard to safety and the environment.

Proper disposal of your old appliance

⚠ WARNING

Before disposing of your old appliance, make it inoperable so that it cannot be a source of danger. To do this, have a qualified technician disconnect the appliance from the mains supply and remove the mains lead.

The appliance may not be disposed of in the household rubbish.

Information about collection dates and public refuse disposal sites is available from your local refuse department or council.

Correct Disposal of This Product (Waste Electrical & Electronic Equipment)

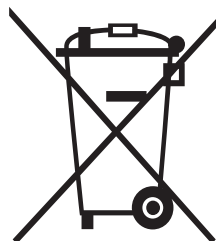

(Applicable in countries with separate collection systems)

This marking on the product, accessories or literature indicates that the product and its electronic accessories (e.g. charger, headset, USB cable) should not be disposed of with other household waste at the end of their working life. To prevent possible harm to the environment or human health from uncontrolled waste disposal, please separate these items from other types of waste and recycle them responsibly to promote the sustainable reuse of material resources.

Household users should contact either the retailer where they purchased this product, or their local government office, for details of where and how they can take these items for environmentally safe recycling.

Business users should contact their supplier and check the terms and conditions of the purchase contract. This product and its electronic accessories should not be mixed with other commercial wastes for disposal.

For information on Samsung's environmental commitments and product specific regulatory obligations e.g. REACH visit: <https://www.samsung.com/uk/sustainability/environment/>

Installing the hob

⚠ WARNING

Be sure the new appliance is installed and grounded only by qualified personnel. Please observe this instruction. The warranty will not cover any damage that may occur as a result of improper installation.

Technical data is provided at the end of this manual.

Safety instructions for the installer

- A device must be provided in the electrical installation that allows the appliance to be disconnected from the mains at all poles with a contact opening width of at least 3 mm. Suitable isolation devices include line protecting cut - outs, fuses (screw type fuses are to be removed from the holder), earth leakage trips and contactors.
- With respect to fire protection, this appliance corresponds to EN 60335 - 2 - 6. This type of appliance may be installed with a high cupboard or wall on one side.
- The installation must guarantee shock protection.
- The kitchen unit in which the appliance is fitted must satisfy the stability requirements of DIN 68930.
- For protection against moisture, all cut surfaces are to be sealed with a suitable sealant.
- On tiled work surfaces, the joints in the area where the hob sits must be completely filled with grout.
- On natural, artificial stone, or ceramic tops, the snap action springs must be bonded in place with a suitable artificial resin or mixed adhesive.
- Ensure that the seal is correctly seated against the work surface without any gaps. Additional silicon sealant must not be applied; this would make removal more difficult when servicing.
- The hob must be pressed out from below when removed.
- A board can be installed underneath the hob.
- The ventilation gap between the worktop and front of the unit underneath it must not be covered.

Tools you will need



Pencil



Phillips Head Screwdriver



Ruler or Straightedge



Safety Glasses



Saber Saw

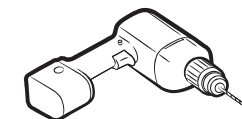

Drill

Connecting to the mains power supply

Before connecting, check that the nominal voltage of the appliance, that is, the voltage stated on the rating plate, corresponds to the available supply voltage. The rating plate is located on the lower casing of the hob.

⚠ WARNING

Shut off power to circuit before connecting wires to circuit.

The heating element voltage is AC 230 V~. The appliance also works perfectly on networks with AC 220 V~ or AC 240 V~. The hob is to be connected to the mains using a device that allows the appliance to be disconnected from the mains at all poles with a contact opening width of at least 3 mm, eg. automatic line protecting cut - out, earth leakage trips or fuse.

⚠ WARNING

The cable connections must be made in accordance with regulations and the terminal screws tightened securely.

⚠ WARNING

Once the hob is connected to the mains supply, check that all cooking zones are ready for use by briefly switching each on in turn at the maximum setting with suitable cookware.

⚠ WARNING

Pay attention (conformity) to phase and neutral allocation of house connection and appliance (connection schemes); otherwise, components can be damaged. Warranty does not cover damage resulting from improper installation.

⚠ WARNING

If the supply cord is damaged, it must be replaced by the manufacturer, its service agent or similarly qualified persons in order to avoid a hazard.

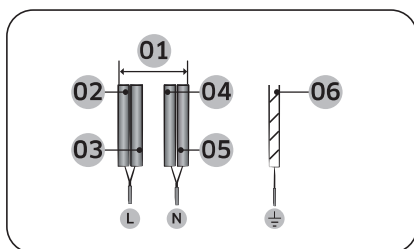

1N~ (32A)

01	220-240 V~	04	Blue
02	Black	05	Gray
03	Brown	06	Green/Yellow

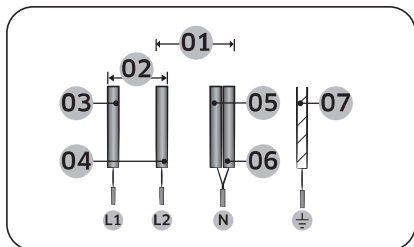

2N~ (16A): Separate the 2-phase wires (L1 and L2) before connection.

01	220-240 V~	05	Blue
02	380-415 V~	06	Gray
03	Black	07	Green/Yellow
04	Brown		

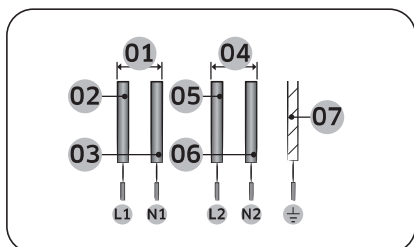

2 x 1N~ (16A): Separate the wires before connection.

01	220-240 V~	05	Brown
02	Black	06	Gray
03	Blue	07	Green/Yellow
04	220-240 V~		

⚠ WARNING

For correct supply connection, follow the wiring diagram attached near the terminals.

Installing into the countertop

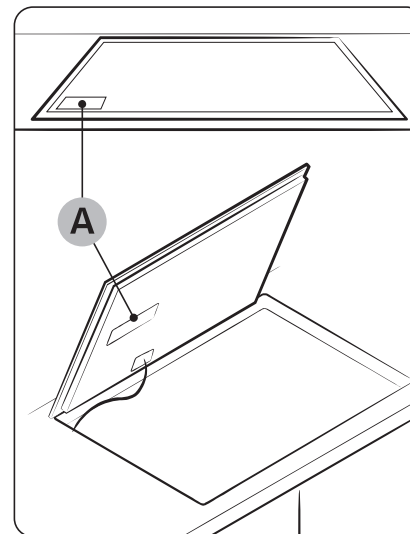

A. Serial number

📖 NOTE

Make a note of the serial number on the appliance rating label prior to installation. This number will be required in the case of requests for service and is no longer accessible after installation, as it is on the original rating plate on the upperside or underside of the appliance.

📖 NOTE

Pay special attention to the minimum space and clearance requirements.

📖 NOTE

The bottom of the hob is equipped with a fan. If there is a drawer under the hob it should not be used to store small objects or paper, since they could damage the fan or interfere with the cooling if they are sucked into it.

Installing the hob

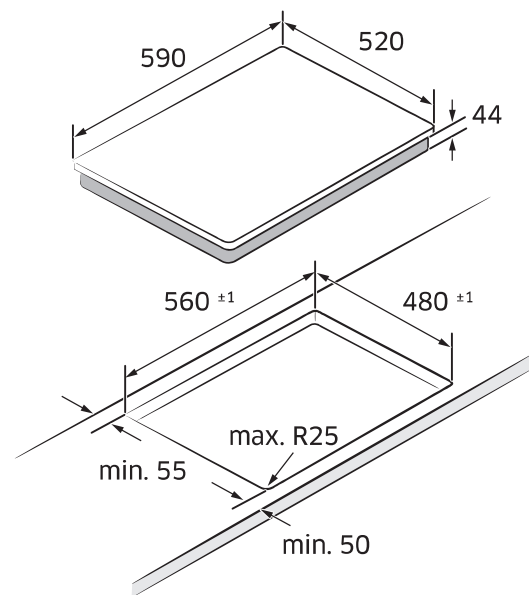
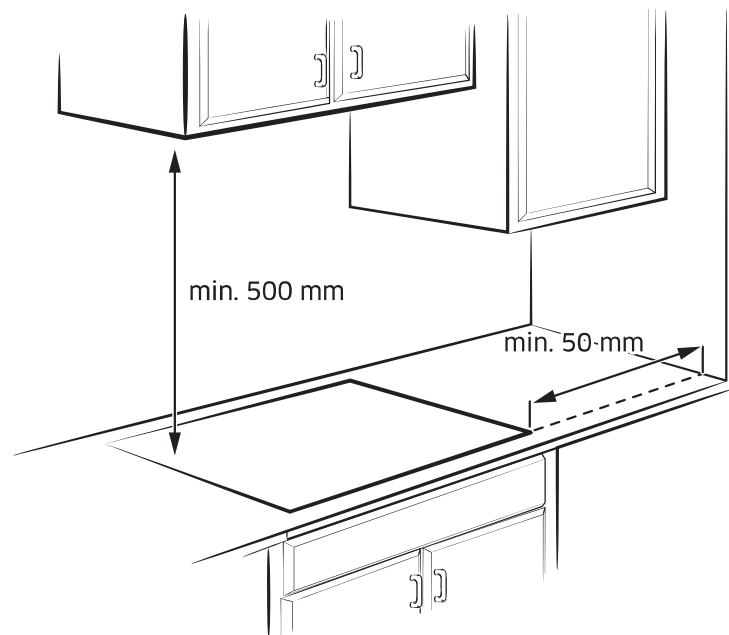

Unit : mm

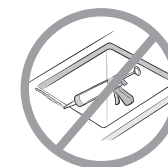

Flushed Fit Type (Only NZ6*****FK model can be installed)

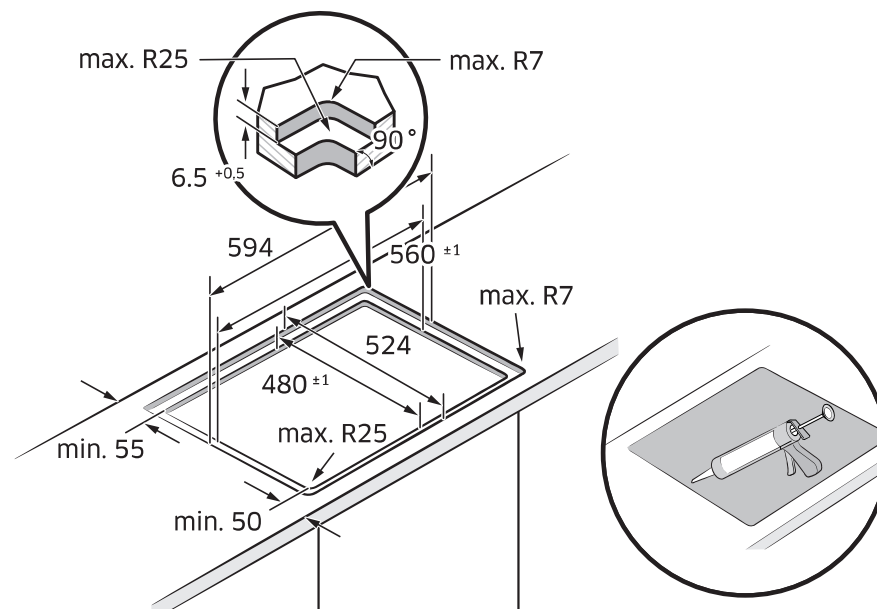

Drawer	Oven

Before you start

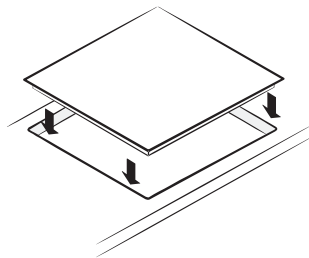
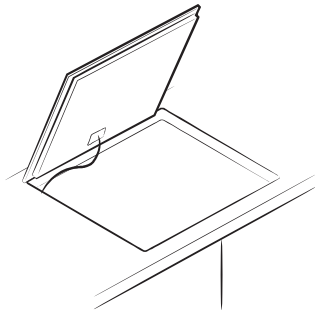
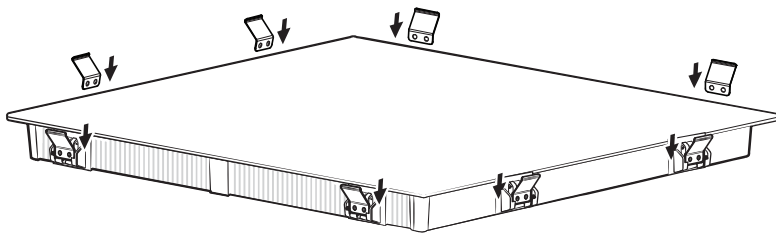

Components

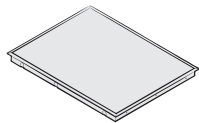

Induction hob

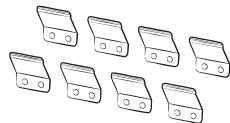

Bracket Spring

Cooking zones

NZ64B6056**

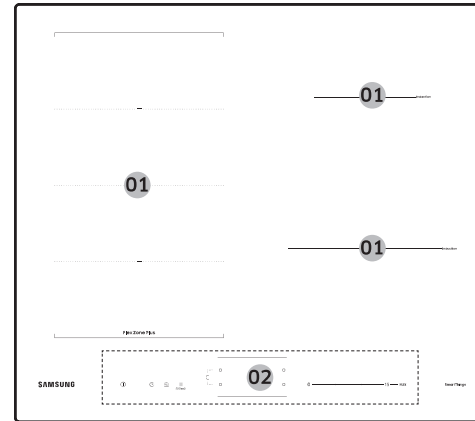

NZ64B6058**

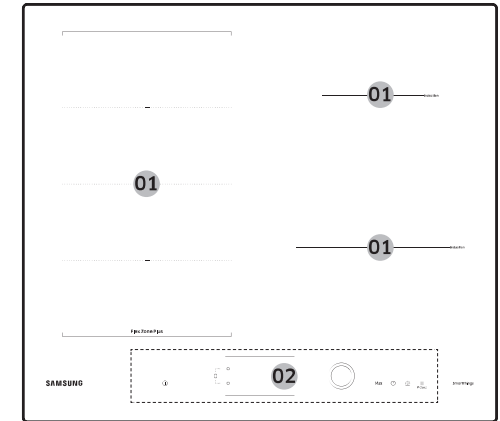

NZ63B6056**

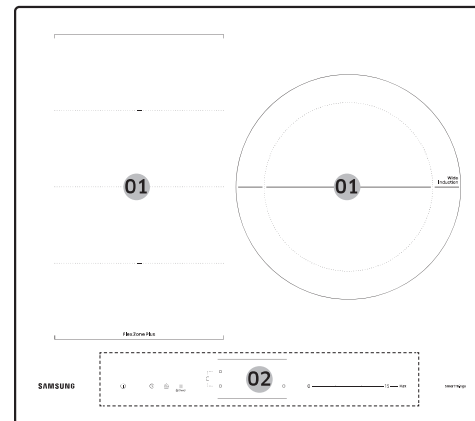

NZ63B6058**

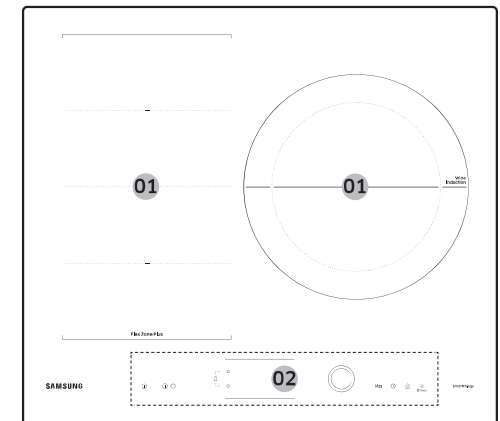

01 Induction cooking zone

02 Control panel

Before you start

Control panel

Control panel 1 - NZ64B6056**

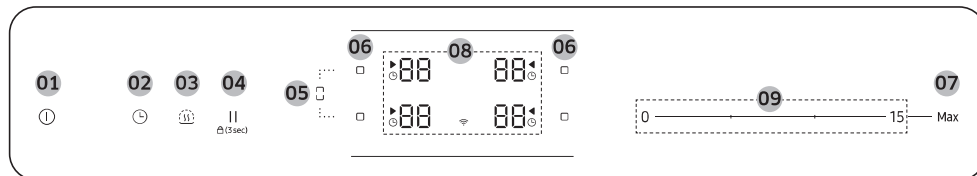

Control panel 2 - NZ64B6058**

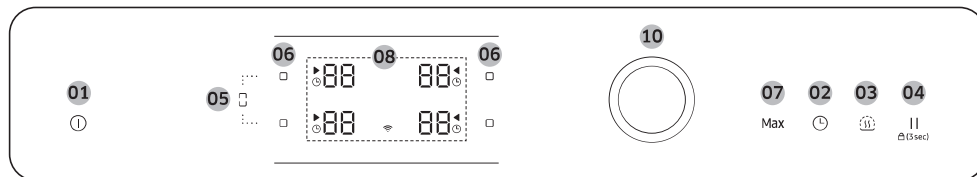

Control panel 3 - NZ63B6056**

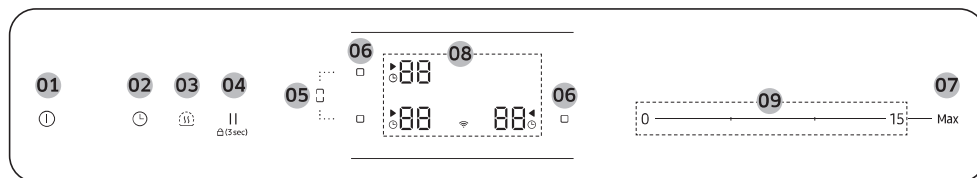

Control panel 4 - NZ63B6058**

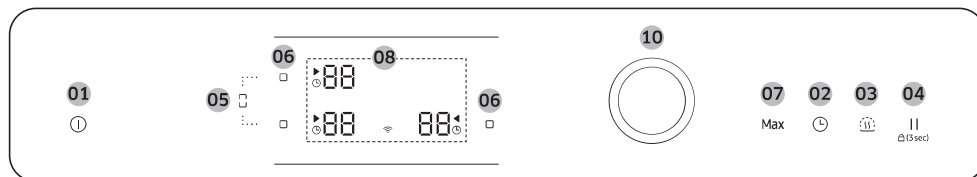

01		On/Off	To activate and deactivate the hob.
02		Timer	To turn timer on or off and set timer.
03		Keep warm	To keep cooked food warm.
04		Pause & Lock	To switch all cooking zones on to the low power setting. Press 3 seconds to lock or unlock the control panel. (Child safety lock)
05		Flex zone	To select the flex zone.
06		Cooking zone	To select the cooking zone.
07		Max Max Boost	To activate the function.
08		Display	To show for heat settings, residual heat, and Wi-Fi connection.
09		Control bar	To set a heat setting and increase or decrease the time.
10		Control knob	To set a heat setting and increase or decrease the time.

Induction heating

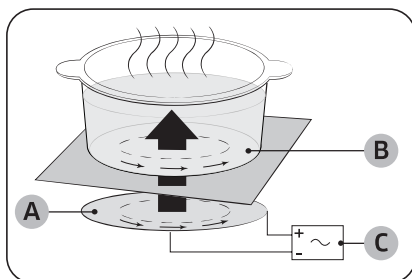

- A. Induction coil
- B. Induced currents
- C. Electronic circuits

- **The Principle of Induction Heating:** When you place your cookware on a cooking zone and you turn it on, the electronic circuits in your induction hob produce “induced currents” in the bottom of the cookware which instantly raise cookware’s temperature.
- **Greater speed in cooking and frying:** As the pan is heated directly and not the glass, the efficiency is greater than in other systems because no heat is lost. Most of the energy absorbed is transformed into heat.

Safety shutoff

If one of the cooking zones is not switched off or the power level is not adjusted after an extended period of time, that particular cooking zone will automatically switch itself off.

The cooking zones switch themselves off at the following times.

Power level	Switch off
1-3	After 6 hours
4-6	After 5 hours
7-9	After 4 hours
10-15	After 1.5 hours

NOTE

If the Hob is overheated because of abnormal operation, will be displayed. And the Hob will be switched off.

NOTE

If cookware is unsuitable, too small, or no cookware has been placed on the cooking zone, will be displayed. And after 1 minute the corresponding cooking zone will be switched off.

NOTE

Should one or more of the cooking zones switch off before the indicated time has elapsed, see the “Troubleshooting”.

Other reasons why a cooking zone will switch itself off

All cooking zones will switch themselves off if liquid boils over on the control panel.

The automatic shutoff will also be activated if you place a damp cloth on the control panel. In both of these instances, the appliance will need to be switched on again using the **On/Off** key after the liquid or the cloth has been removed.

Before you start

Residual heat indicator

When an individual cooking zone or the hob is turned off, the presence of residual heat is shown with an **H**, **H** (for "hot") in the corresponding cooking zone display. Even after the cooking zone has been switched off, the residual heat indicator goes out only after the cooking zone has cooled.

You can use the residual heat for thawing or keeping food warm.

⚠ WARNING

As long as the residual heat indicator is illuminated, there is a risk of burns.

⚠ WARNING

If the power supply is interrupted, the **H**, **H** symbol will go out and information about residual heat will no longer be available.

However, it may still be possible to burn yourself. This can be avoided by always taking care when near the hob.

Temperature detection

If for any reason the temperatures on any of the cooking zones were to exceed the safety levels, the cooking zone will automatically reduce to a lower power level.

When you have finished using the hob, the cooling fan will continue to run until the hob's electronics has cooled down. And the cooling fan switches itself off depending upon the temperature of the electronics.

Cookware

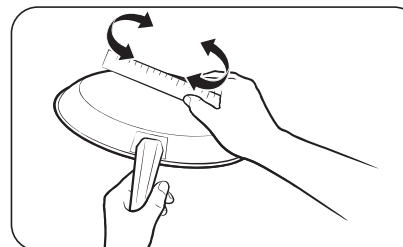

Use flat-bottomed cookware that completely contacts the entire cooking zone. Check for flatness by rotating a ruler across the bottom of the cookware. Be sure to follow all the recommendations for using cookware.

- Use cookware made with the correct material for induction cooking.
- Use quality cookware with heavier bottoms for better heat distribution. This gives best cooking results.
- Match the cookware size to the quantity of food being prepared.
- Do not let cookware boil dry. This may cause permanent damage in the form of breakage, fusion, or marring that can affect the ceramic hob. (This type of damage is not covered by your warranty).
- Do not use dirty cookware or cookware with heavy grease buildup. Always use cookware that is easy to clean after cooking.

⚠ CAUTION

- The cooking zones may appear cooled down after they have been turned off. However, the glass surface may be hot from residual heat transferred from the cookware. The risk of burns is still present.
- Do not touch hot cookware directly with your hands. Always use oven mitts or pot holders to protect your hands from burns.
- Do not slide cookware across the hob surface. Doing so may permanently damage the hob.

Cookware for induction cooking zones

The Induction burner can only be turned on when cookware with a magnetic base is placed on one of the cooking zones. You can use the cookware identified as suitable below.

Material	Suitability
Steel, enameled steel, cast iron	Yes
Stainless steel	Yes (If magnet sticks to the bottom of the cookware)
Aluminum, copper, brass, glass, ceramic, porcelain	No

NOTE

- Cookware appropriate for induction cooking is labelled as suitable by the manufacturer.
- Certain cookware can make noises when being used on induction cooking zones.
- These noises do not indicate that the hob is malfunctioning and do not affect its operation in any way.
- Special stainless-steel cookware may not be suitable for induction cooking. Check if the base of the cookware is attracted by a magnet.

Cookware sizes for induction cooking zones

Induction cooking zones adapt automatically to the bottom size of the cookware up to a certain limit. However, the magnetic part of the bottom of the cookware must have a minimum diameter depending upon the size of the cooking zone. For best results, use cookware whose ferromagnetic diameter match that of a burner. If the cookware is not sensed by the burner, try a smaller sized burner.

NOTE

For Cookware diameter, please refer to the model's Cooking zones specifications.

Before you start

Other induction cookware

Some cookware has thin magnetic material on the bottom to work with an induction heating hob. These cookware has weak magnetism and may not work well. (Weak magnetism means a magnet does not stick firmly or the area where the magnet sticks is small.)

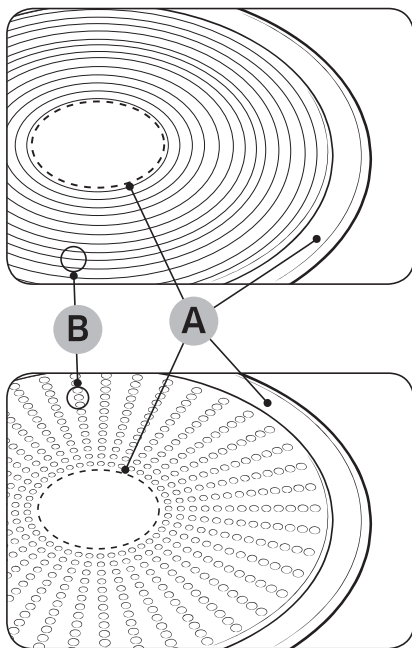

- Even though cookware are designed for an induction hob, the heating performance could be weak or sometimes the hob may not detect the cookware depending on the size and strength of the magnetic area on the bottom of the cookware.

- A.** Area where magnet does not stick
- B.** Area where magnet sticks

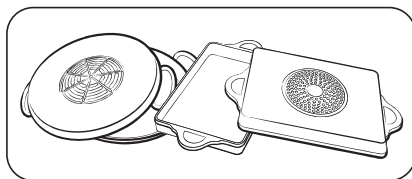

When using large cookware with a smaller ferromagnetic element, only the ferromagnetic element heats up. Consequently, heat might not be uniformly distributed.

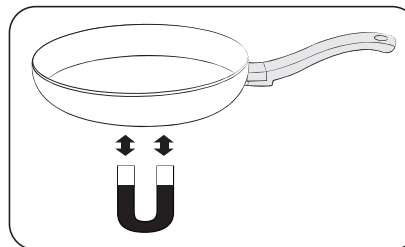

Suitability test



Cookware is suitable for induction cooking if a magnet sticks to the bottom of the cookware and the cookware is labelled as suitable by the cookware manufacturer.

- You can recognise good cookware by their bases. The base is supposed to be as thick and flat as possible.
- When buying new cookware, pay special attention to the diameter of the base. Manufacturers often give only the diameter of the upper rim.
- Do not use cookware which have damaged bases with rough edges or burrs. Damaged cookware can scratch the ceramic hob permanently if you slide them across the surface.
- When cold, cookware bases are normally bowed slightly inwards (concave). They must not be bent outwards (convex).
- If you want to use a special type of cookware, for example, a pressure cooker, a simmering pan, or a wok, please follow the manufacturer's instructions.

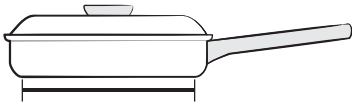
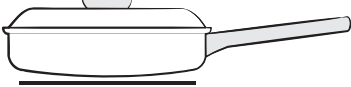
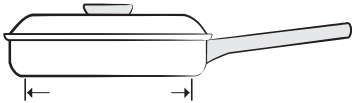
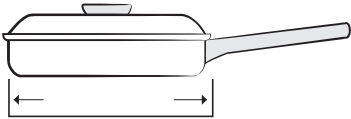
Correct positioning

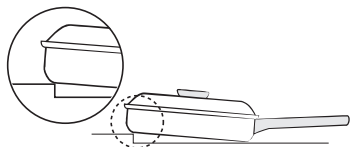
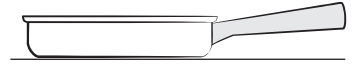
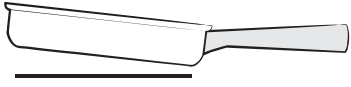
Correct	Incorrect
	
Flat-bottomed cookware and straight sides	Cookware with curved or warped bottoms or sides
	
The cookware meets or exceeds the recommended minimum size for the cooking zone.	The cookware does not meet the minimum size required for the current cooking zone.
	
The cookware rests completely on the hob surface.	The cookware rests on the hob trim or does not rest completely on the hob surface.
	
The cookware is properly balanced.	The heavy handle causes the cookware to tilt.

Energy saving tips

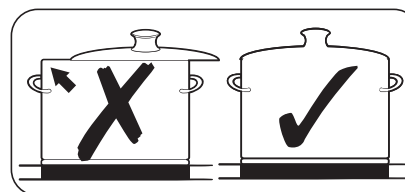
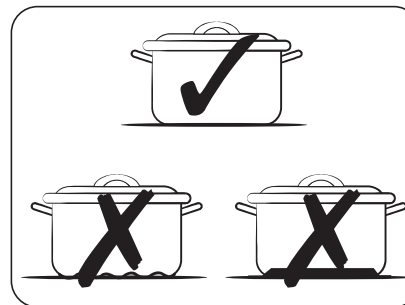





Follow these tips to save power consumption.

- Always put cookware on a cooking zone before you turn the corresponding burner on.
- Keep the cooking zones and cookware bases clean. Otherwise, more power will be consumed.
- Firmly close the cover of cookware if available. This will reduce power consumption.
- Turn the working burner off before the end of the cooking time. Use the residual heat to keep food warm.

Correct positioning

You can test cookware to see if they are suitable for use with the product.

1. Press the **On/Off**  key for 1-2 seconds to turn on the hob.
2. Press the **Pause & Lock**  key for 3 seconds to activate the child safety lock.
3. Press the **Timer**  key for 3 seconds to activate the cookware suitability test mode.
4. Place the cookware on the one of the cooking zones, and then press and hold the **Cooking zone**  key for 3 seconds.

Display	Description
0	Cookware is unsuitable
1 - 7	Cookware is suitable, but inefficient
8 - 10	Cookware is suitable

Before you start

Using the touch buttons

To operate the touch buttons, touch the desired button with the tip of your pointed finger until the relevant displays illuminate or go out, or until the desired function is activated.

Ensure that you are touching only one button when operating the appliance. If your finger is too flat on the button, an adjacent button may be actuated as well.

Operating noises

If you can hear:

- **Cracking noise:** cookware is made of different materials.
- **Whistling:** you use more than two cooking zones and the cookware is made of different materials.
- **Humming:** you use high power levels.
- **Clicking:** electric switching occurs.
- **Hissing, Buzzing:** the fan operates.

The noise are normal and do not refer to any defects.

WARNING

Do not use cookware of different size and material.

Using cookware of different sizes or materials may cause noises and vibrations.

NOTE

Using low power levels (1-5) may cause clicking noises.

Initial cleaning

Wipe the ceramic glass surface with a damp cloth and ceramic hob glass cleaner.

WARNING

Do not use caustic or abrasive cleaners. The surface could be damaged.

Operation



Switching the appliance on

The appliance is switched on using the **On/Off**  key. Press the **On/Off**  key for approximately 1-2 seconds.

NOTE

After the **On/Off**  key has been actuated to switch on your appliance, a power level must be selected within approximately 20 seconds. Otherwise, the appliance will switch itself off for safety reasons.

Switching the appliance off

To completely switch off the appliance, use the **On/Off**  key. Press the **On/Off**  key for approximately 1-2 seconds.

NOTE

After switching off a single cooking zone or the entire cooking surface, the presence of residual heat will be indicated in the digital displays of the corresponding cooking zones in the form of an **H**, **H** two steps for “hot”. The temperature is lowered, **H**, **H** will be disappeared.

Selecting cooking zone and power level

1. For selecting the cooking zone, press the corresponding **Cooking zone**  key.
2. For setting and adjusting the power level, use the Control bar or Control key or Control knob.

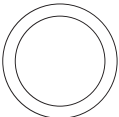
Control bar	0 ————— 15 — Max
Control Knob	 Max

NOTE

- The default level is set to 15 when selecting the cooking zone.
- If more than one key is pressed for longer than 8 seconds,  will show in the cooking zone display.

Suggested settings for cooking specific foods

The numbers in the table below are guidelines. The power level required for various cooking methods depend on a number of variables, including the quality of the cookware being used and the type and amount of food being cooked.

Power level	Cooking method	Examples for Use
14-15	Warming / Sautéing / Frying	Warming large amounts of liquid, boiling noodles, searing meat, browning goulash, braising meat
8-11	Intensive frying	Steak, sirloin, hash browns, sausages, pancakes / griddle cakes
7-10	Frying	Schnitzel / chops, liver, fish, rissoles, fried eggs
5-7	Boiling	Cooking up to 1.5 l liquid, potatoes, vegetables
2-4	Steaming / Stewing / Boiling	Steaming and stewing of small amounts of vegetables, boiling rice and milk dishes
1-2	Melting	Melting butter, dissolving gelatine, melting chocolate

NOTE

You will need to adjust the power level according to specific cookware and foods.

Operation

Max Boost

The **Max Boost** function makes additional power available to the each cooking zones. (example : bring a large volume of water to the boil)
After **Max Boost** times, the cooking zones automatically sets back to the highest heat setting.

NOTE

- In certain circumstances, the **Max Boost** function may be deactivated automatically to protect the internal electronic components of the hob. For example, It is impossible to output max power on Flex zone rear and Flex zone front at the same time.
- Refer to your model's Cooking zones specification for **Max Boost** time.

Power management



The cooking zones have a maximum power available to them.
If this power range is exceeded by switching on the **Max Boost** function, Power Management automatically reduces the power level of cooking zone.
The display for this cooking zone alternates for some seconds between the set power level and the maximum possible power level. After then, the display changes from the set power level to maximum possible power level.

Using the Flex zone (Only for Flex zone applied models)

The Flex function can operate complete left side cooking zone for using large size cookware. (example : oval cookware, fish kettle)

1. Press the **Flex zone**  key.
2. For setting and adjusting the power level, use the **Power level** key.

NOTE

- Press the **Flex zone**  key during operating, **Flex zone** function will be off.
- If you press the **Flex zone**  key while each burner operation different level, burner set at a high level.

Flex zone Plus (Only for Flex zone plus applied models)

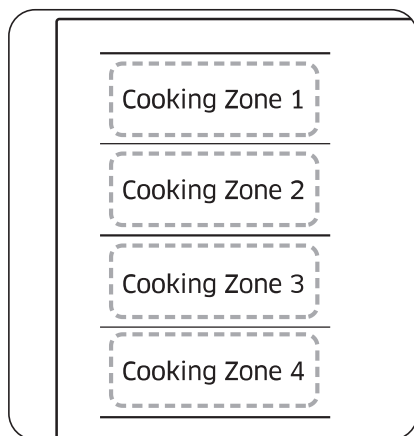

The Flex zone is the large cooking area located on the left side of the hob (see the figure left) that is specially designed to accommodate multiple pots and pans of varying shapes and sizes at once. The Flex zone has four zones that are operated by individual inductors, allowing you to cook regardless of where cookware is placed on a cooking zone.

With Flex zone Plus, you can use a combination of different cooking zones to enlarge the cooking area. Press the **Flex zone**  key to use the cooking zone as follows.

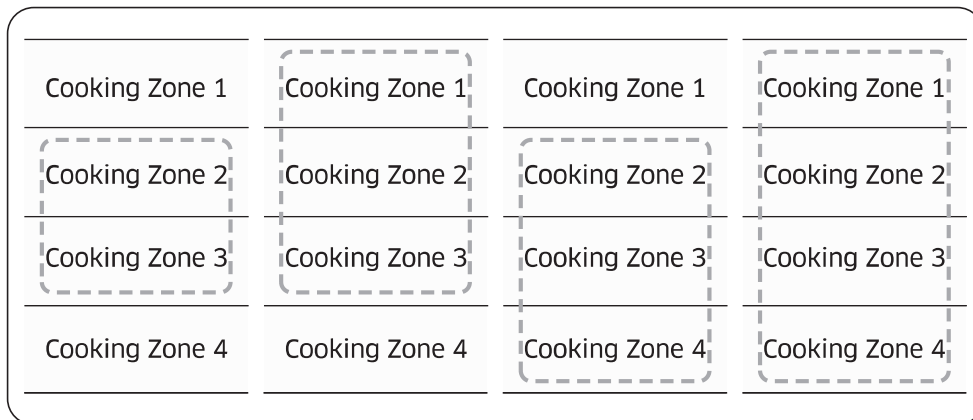



NOTE

- When using only one cooking zone, the diameter of the bottom of the cookware must be less than 14 cm.
- The hob may take 5-10 seconds to recognise the position of cookware.
- Noises may occur while the hob recognises the cookware.
- Do not remove cookware during cooking. For safety purposes, the hob automatically stops if cookware has been removed for more than 5 seconds.

Using the Flex zone Plus (Only for Flex zone plus applied models)



1. Press the **Flex zone**  key.
2. For setting and adjusting the power level, use the **Power level** key.

NOTE

- If you press the **Flex zone**  key during operating, **Flex zone** function will be off.
- If you press the **Flex zone**  key while each cooking zone is operating at different levels, it will be automatically adjusted to higher level.
- When moving or adding cookware to a new Flex zone, cancel the current operation, and then press the corresponding **Cooking zone**  key to activate the cooking zone.

Operation

Keep Warm

1. Use this function to keep cooked food warm. Press the corresponding **Cooking zone**  key.
2. Press the **Keep warm**  key.
3. The cooking zone display will be changed.
4. Press the **Keep warm**  key again to turn off the cooking zone.



Timer

Using the timer as a safety shutoff

If a specific time is set for a cooking zone, the cooking zone will shut itself off once this period of time has elapsed. This function can be used for multiple cooking zones simultaneously.

Setting the timer

The cooking zone(s) for which you want to apply the safety shutoff must be switched on.



1. Press the **Timer**  key.
2. Set timer by repeatedly pressing the **Timer**  key.
3. To cancel the timer settings, hold the **Timer**  key for 3 seconds.

NOTE



- To change the settings quicker, press and hold any of the **Timer**  key until the desired value is reached.
- When the timer is terminated, it sounds a beep several times. However, the cooking zone will not be turned off.

Pause/Resume

The **Pause/Resume** function simultaneously switches all cooking zones that are switched on to the low power setting and then back to the power level that was previously set. This function can be used to briefly interrupt and then continue the cooking process e.g. to take a telephone call.

When the **Pause/Resume** function is activated, all keys except for the **Pause & Lock**  and the **On/Off**  keys are disabled.

To resume cooking, press the **Pause & Lock**  key again.

	Control Panel	Display
To Switch On	Press the Pause & Lock  key	
To Switch Off	Press the Pause & Lock  key	Return to previous power level

Quick stop

This option reduces the step and time it takes to stop cooking.

To switch off a cooking zone, press the **Cooking zone**  key for 2 seconds.



NOTE

The **Flex zone**  key does not support quick stop function.



Child safety lock

You can use the child safety lock to safeguard against unintentionally turning on a cooking zone and activating the cooking surface. Also the control panel, with the exception of the **On/Off**  key (Only turn off control), can be locked in order to prevent the settings from being changed unintentionally, for example, by wiping over the panel with a cloth.

Switching the child safety lock On/Off







1. Press the **Pause & Lock**  key for approximately 3 seconds. An acoustic signal will sound as confirmation.
2. Press any key.  will appear in the displays, indicating the child safety lock has been activated.
3. For switching the child safety lock off, press the **Pause & Lock**  key again for 3 seconds.
An acoustic signal will sound as confirmation.

NOTE

- Regardless of power on/off, child lock is activated.
- You can set the child safety lock during cooking. To turn off the burner with the child safety lock on, press the **On/Off**  key or turn off the child safety lock first and then press the corresponding **Cooking zone**  key.

Maximum power limit

This function allows you to adjust the maximum power of the unit.





1. Keep the power off.
2. Press the **Pause & Lock**  key for approximately 3 seconds to turn on the child safety lock.
3. Press the left front **Cooking zone**  key and right front **Cooking zone**  key at the same time for approximately 3 seconds.
4. Press the **Timer**  key for approximately 3 seconds.
The displays will show  and current maximum power.
5. You can adjust the power limit using the **Pause & Lock**  key. (3000 W, 4000 W, 7400 W)
6. Press the **On/Off**  key to set the setting.

NOTE

In low-power (3000 W, 4000 W) mode, the power level will be adjusted automatically.

Operation

Sound on/off

1. Press the **On/Off**  key for approximately 1-2 seconds.
2. Press the **Timer**  key for 3 seconds within 10 seconds after the power has turned on.
3. Sound will turn off and  will be displayed in the display.
4. To change the sound setting, repeat steps 1 and 2. Sound will turn on and  will be displayed in the display.

NOTE

It is not possible to change the sound settings after 10 seconds from turning the power on.

Smart Connect



The hob has built in Wi-Fi module that you can use to sync the hob with the SmartThings app. On the smartphone app, you can:

- monitor the operating status and the power level settings of the hob elements.
- check and change the timer settings.

Functions that can be operated from the SmartThings app may not work smoothly if communication conditions are poor or the product is installed in a place with a weak Wi-Fi signal.

How to connect the hob

Before you can use the remote features of your Samsung hob, you must pair it to the SmartThings app.

1. Download and open the SmartThings app on your smart device.
2. Press the **On/Off**  key for approximately 1-2 seconds to turn the hob on.
3. Press the **Pause & Lock**  key for approximately 3 seconds to turn on the child safety lock.
4. Follow the app's instructions, and then press and hold the **Max** key for 3 seconds.
5. While the connection is being made, the Wi-Fi indicator will blink. Once the process is complete, the indicator glows without blinking. Now the hob is connected successfully.
6. If the Smart Connect Wi-Fi indicator does not turn on, follow the instruction in the app to reconnect.

NOTE

- Make sure to set the Smart Connect function only when no hob operation is in process.
- For further instructions, refer to the web manual at www.samsung.com

Wi-Fi On/Off



- To change the Wi-Fi On/Off, repeat steps 2 to 4.

Hood control

This product features a Bluetooth device that you can use to connect the hob to Samsung hood control models. Through the Bluetooth connection, you can use the hood control function on the SmartThings app.

To find out more about Samsung hood control-enabled models, visit www.samsung.com.

To connect to a hood control model

1. Download and run the SmartThings app on your smartphone. Then, complete the Smart Connect procedure to connect to the hob.
2. Follow the Bluetooth instructions of the hood control model and activate the Bluetooth connection.
3. Press and hold the **Timer**  and **Pause & Lock**  keys simultaneously to make the Bluetooth connection. When the Bluetooth connection is successfully established,  appears on the display.
4. Follow the instructions in the user manual of the hood control model and the App guide to use the hood control.

NOTE

- If the Smart Connect connection is not successful, you cannot use the SmartThings app to monitor and control the hood.
- Without a Smart Connect connection to the hob, you can use a Bluetooth connection to pair the hob with the hood and sync them. To do this, follow steps 2 and 3 above.

Maintaining your appliance

Hob

WARNING

Cleaning agents must not come into contact with a heated ceramic glass surface: All cleaning agents must be removed with adequate amounts of clean water after cleaning because they can have a caustic effect when the surface becomes hot. Do not use any aggressive cleaners such as grill or oven sprays, scouring pads or abrasive pan cleaners.

NOTE

Clean the ceramic glass surface after each use when it is still warm to the touch. This will prevent spillage from becoming burnt onto the surface. Remove scales, watermarks, fat drippings and metallic discolouration with the use of a commercially available ceramic glass or stainless steel cleaner.

Light soiling

1. Wipe the ceramic glass surface with a damp cloth.
2. Rub dry with a clean cloth. Remnants of cleaning agent must not be left on the surface.
3. Thoroughly clean the entire ceramic glass cooking surface once a week with a commercially available ceramic glass or stainless steel cleaner.
4. Wipe the ceramic glass surface using adequate amounts of clean water and rub dry with a clean lint - free cloth.

Maintaining your appliance

Stubborn soiling

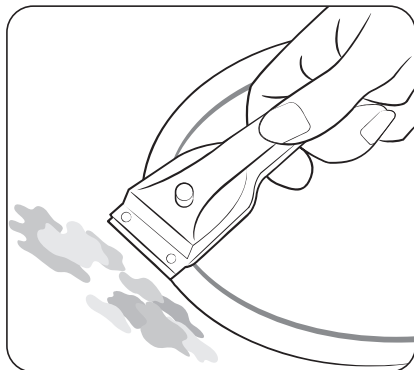

1. To remove food that has boiled over and stubborn splashes, use a glass scraper.
2. Place the glass scraper at an angle to the ceramic glass surface.
3. Remove soiling by scraping with the blade.

 **NOTE**

Glass scrapers and ceramic glass cleaners are available from specialty retailers.

Problem dirt

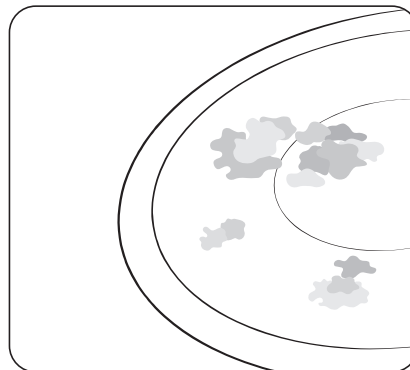

1. Remove burnt-on sugar, melted plastic, aluminium foil or other materials with a glass scraper immediately and while still hot.

 **WARNING**

There is a risk of burning yourself when the glass scraper is used on a hot cooking zone:

2. Clean the hob as normal when it has cooled down. If the cooking zone on which something has melted has been allowed to cool, warm it up again for cleaning.

 **NOTE**

Scratches or dark blemishes on the ceramic glass surface, caused, for example, by a pan with sharp edges, cannot be removed. However, they do not impair the function of the hob.

Hob frame (option)

⚠ WARNING

Do not use vinegar, lemon juice or scale remover on the hob frame; otherwise dull blemishes will appear.

1. Wipe the frame with a damp cloth.
2. Moisten dried debris with a wet cloth. Wipe and rub dry.

To avoid damaging your appliance

- Do not use the hob as a work surface or for storage.
- Do not operate a cooking zone if there is no pan on the hob or if the pan is empty.
- Ceramic glass is very tough and resistant to temperature shock, but it is not unbreakable. It can be damaged by a particularly sharp or hard object dropping onto the hob.
- Do not place pans on the hob frame. Scratching and damage to the finish may occur.
- Avoid spilling acidic liquids, for example, vinegar, lemon juice and descaling agents, onto the hob frame, since such liquids can cause dull spots.
- If sugar or a preparation containing sugar comes into contact with a hot cooking zone and melts, it should be cleaned off immediately with a kitchen scraper while it is still hot. If allowed to cool, it may damage the surface when removed.
- Keep all items and materials that could melt, for example, plastics, aluminium foil and oven foils, away from the ceramic glass surface. If something of this nature melts onto the hob, it must be removed immediately with a scraper.





Troubleshooting and service

Troubleshooting



A fault may result from a minor information that you can correct yourself with the help of the following instructions. Do not attempt any further repairs if the following instructions do not help in each specific case.

⚠ WARNING

Repairs to the appliance are to be performed only by a qualified service technician. Improperly effected repairs may result in considerable risk to the user. If your appliance needs repair, please contact your customer service centre.

Problem	Possible cause	Solution
What should I do if the cooking zones are not functioning?	<ul style="list-style-type: none">• The fuse in the house wiring is not intact.	<ul style="list-style-type: none">• If the fuses trip a number of times, call an authorised electrician.
What should I do if the cooking zones will not switch on?	<ul style="list-style-type: none">• The On/Off  key was accidentally actuated.• The control panel is partially covered by a damp cloth or liquid.	<ul style="list-style-type: none">• The appliance is properly switched on.• Clean the control panel.
What should I do if the display except for  ,  the residual heat indicator suddenly disappears?	<ul style="list-style-type: none">• The On/Off  key was accidentally actuated.• The control panel is partially covered by a damp cloth or liquid.	<ul style="list-style-type: none">• The appliance is properly switched on.• Clean the control panel.
What should I do if, after the cooking zones have been switched off, residual heat is not indicated in the display	<ul style="list-style-type: none">• The cooking zone was only briefly used and therefore did not become hot enough.	<ul style="list-style-type: none">• If the cooking zone is hot, please call a local service centre.

Troubleshooting and service

Information code	Possible cause	Solution
E0	There is a problem with the burner temperature sensor.	Restart the appliance using the On/Off  key. If the problem continues, disconnect power for more than 30 seconds. Then, restart the appliance and try again. If the problem still continues, contact a local service centre.
E1	The temperature is sensed higher than specified.	
E2	There is a problem with the PBA sensor.	
A2	The DC Motor fails to operate because of problems with the PCB or wiring, or electrical disturbance on the motor blade.	
B0	A key is being pressed for more than 8 seconds.	Check if the key is wet or is being pressed. If the problem continues, restart the appliance using the On/Off  key. If the problem still continues, contact a local service centre.
F0	Communications between main and sub PCBs fail.	Restart the appliance using the On/Off  key. If the problem continues, disconnect power for more than 30 seconds. Then, restart the appliance. If the problem still continues, contact a local service centre.
F2	The touch-enabled IC communicates abnormally.	
UP	It is out of normal voltage (220 ~ 240 V).	Check home power environment.
U3	If the cooking container is not suitable for the induction, or operates without the cooking container, it is displayed.	Use a cooking container suitable for inductions.

What should I do if the cooking zone will not switch on or off?

This could be due to one of the following possibilities:

- The control panel is partially covered by a damp cloth or liquid.
- The child safety lock is on, and display .

What should I do if the display is illuminated?

Check for the following:

- The control panel is partially covered by a damp cloth or liquid. To reset, press the **On/Off**  key.
- If liquid has overflowed on control panel, please wipe the liquid.

What should I do if the display is illuminated?

Check for the following:

- The hob is overheated because of abnormal operation.
- After hob is cooled down, press the **On/Off**  key for resetting.

What should I do if the display is illuminated?

Check for the following:

- Cookware is unsuitable, too small, or no cookware has been placed on the cooking zone.
- If you use suitable cookware, displayed message will automatically disappear.

What should I do if the cooling fan runs after the hob is turned off?

Check for the following:

- When you have finished using the hob, the cooling fan runs by itself for cooling down.
- After the hob's electronics has cooled down or elapsed max time (10 minutes) the cooling fan will be turned off.
- If you request a service call because of an information made in operating the appliance, the visit from the customer service technician may incur a charge even during the warranty period.

Service

Before calling for assistance or service, please check the section “**Troubleshooting**”. If you still need help, follow the instructions below.

Is it a technical fault?

If so, please contact your customer service centre.

Always prepare in advance for the discussion. This will ease the process of diagnosing the problem and also make it easier to decide if a customer service visit is necessary.

Please take note of the following information.

- What form does the problem take?
- Under what circumstances does the problem occur?

When calling, please know the model and serial number of your appliance. This information is provided on the rating plate as follows:

- Model description
- S/N code (15 digits)

We recommend that you record the information here for easy reference.

- Model:
- Serial number:

When do you incur costs even during the warranty period?

- If you could have remedied the problem yourself by applying one of the solutions provided in the section “**Troubleshooting**”.
- If the customer service technician has to make several service calls because he was not provided with all of the relevant information before his visit and as a result, for example, has to make additional trips for parts. Preparing for your phone call as described above will save you the cost of these trips.

QUESTIONS OR COMMENTS?

COUNTRY	CALL	OR VISIT US ONLINE AT
AUSTRIA	0800 72 67 864 (0800-SAMSUNG)	www.samsung.com/at/support
BELGIUM	02-201-24-18	www.samsung.com/be/support (Dutch) www.samsung.com/be_fr/support (French)
DENMARK	707 019 70	www.samsung.com/dk/support
FINLAND	030-6227 515	www.samsung.com/fi/support
FRANCE	01 48 63 00 00	www.samsung.com/fr/support
GERMANY	06196 77 555 77	www.samsung.com/de/support
ITALIA	800-SAMSUNG (800.7267864)	www.samsung.com/it/support
CYPRUS	8009 4000 only from landline, toll free	www.samsung.com/gr/support
GREECE	80111-SAMSUNG (80111 726 7864) only from land line (+30) 210 6897691 from mobile and land line	www.samsung.com/gr/support
LUXEMBURG	261 03 710	www.samsung.com/be_fr/support
NETHERLANDS	088 90 90 100	www.samsung.com/nl/support
NORWAY	21629099	www.samsung.com/no/support
PORTUGAL	210 608 098 Chamada para a rede fixa nacional Dias úteis das 9h às 20h	www.samsung.com/pt/support
SPAIN	91 175 00 15	www.samsung.com/es/support
SWEDEN	0771-400 300	www.samsung.com/se/support
SWITZERLAND	0800 726 786	www.samsung.com/ch/support (German) www.samsung.com/ch_fr/support (French)
UK	0333 000 0333	www.samsung.com/uk/support
IRELAND (EIRE)	0818 717100	www.samsung.com/ie/support

COUNTRY	CALL	OR VISIT US ONLINE AT
ALBANIA	045 620 202	www.samsung.com/al/support
BOSNIA	055 233 999	www.samsung.com/ba/support
NORTH MACEDONIA	023 207 777	www.samsung.com/mk/support
BULGARIA	0800 111 31 - Безплатен за всички оператори *3000 - Цена на един градски разговор или според тарифата на мобилният оператор 09:00 до 18:00 - Понеделник до Петък	www.samsung.com/bg/support
CROATIA	072 726 786	www.samsung.com/hr/support
CZECH	800 - SAMSUNG (800-726786)	www.samsung.com/cz/support
HUNGARY	0680SAMSUNG (0680-726-7864)	www.samsung.com/hu/support
MONTENEGRO	020 405 888	www.samsung.com/support
POLAND	801-172-678* lub +48 22 607-93-33* * (opłata według taryfy operatora)	http://www.samsung.com/pl/support/
ROMANIA	0800872678 - Apel gratuit *8000 - Apel tarifat în rețea	www.samsung.com/ro/support
SERBIA	011 321 6899	www.samsung.com/rs/support
SLOVAKIA	0800 - SAMSUNG (0800-726 786)	www.samsung.com/sk/support
LITHUANIA	8-800-77777	www.samsung.com/lt/support
LATVIA	8000-7267	www.samsung.com/lv/support
ESTONIA	800-7267	www.samsung.com/ee/support
SLOVENIA	080 697 267 (brezplačna številka)	www.samsung.com/si/support
KOSOVO	038 40 30 90	www.samsung.com/support