

Hisense

LC **LaSeR**
cinema



USER MANUAL

Read the manual carefully and ensure you have fully understood its contents before operating this device for the first time.

English

In order to promote environmental protection and assume social responsibility, we strongly recommend you to acquire the electronic user manual of multi-language through the QR code below.



Zeskanuj kod QR dla elektronicznych instrukcji obsługi w innych językach.

Nuskaitykite QR kodą norėdami rasti elektroninį vartotojų vadovą kitomis kalbomis

Skenējiet QR kodu , lai iegūtu elektroniskās lietotāja rokasgrāmatas citās valodās.

Skaneerige QR-koodi elektrooniliste kasutusjuhendite jaoks teistes keeltes.

Naskenujte QR kód pro elektronické uživatelské příručky v jiných jazycích.

Prehľadajte kód QR pre elektronické príručky používateľov v iných jazykoch

Scan de QR-code voor elektronische gebruiksaanwijzingen in andere talen.

Poskenirajte QR kodo za navodila za uporabo v ostalih jezikih.

Olvassa be a QR-kódot a többi idegen nyelvű elektronikus felhasználói kézikönyvekért.

Skenirajte QR kod za elektronske korisničke priručnike na drugim jezicima.

Сканирайте QR кода за електронни ръководства за потребителя на други езици.

Σαρώστε τον κωδικό QR για ηλεκτρονικά εγχειρίδια χρήσης σε άλλες γλώσσες.

Important Notice

Paragraphs beginning with the symbol  indicate important instructions, tips or conditions for the following settings.



For your own safety and the optimal performance of your device, ensure to read the safety instructions before performing any installation.

Compatibility with 3rd party products, software and services are not guaranteed. We cannot be held liable for any damage or loss suffered whilst operating, using or connecting to incompatible devices or apps.

The recording and playback of content on this or any other device may require permission from the owner of the copyright or other such rights in that content. It is your responsibility to ensure that your use of this or any other device complies with applicable copyright legislation in your country. Please refer to that legislation for more information on the relevant laws and regulations involved or contact the owner of the rights of the content you wish to record or playback.

Read these instructions
Follow all instructions
Heed all warnings
Keep these instructions
All rights reserved.

Authorized EU Representative

Name: Gorenje gospodinjski aparati, d.o.o.

Address: Partizanska cesta 12, 3320 Velenje, Slovenija

Email: info@gorenje.com

Safety Instructions

To ensure safe and correct use of this product, always comply with the following precautions to avoid dangerous situations and damage to your device:

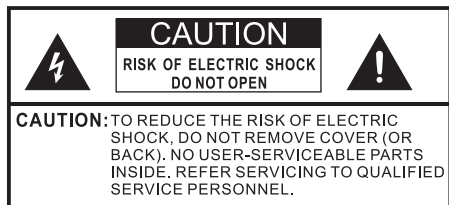

The lightning flash with arrowhead symbol, within an equilateral triangle is intended to alert the user to the presence of uninsulated dangerous voltage within the product's enclosure that may be of sufficient magnitude to constitute a risk of electric shock.



The exclamation point within an equilateral triangle is intended to alert the user to the presence of important operating and maintenance (servicing) instructions in the literature accompanying the appliance.



AC voltage: This symbol indicates that the rated voltage marked with the symbol is AC voltage.



Class II product : This symbol indicates that it does not require a safety connection of protective earthing (ground).

The intended use and ambient conditions for this device

This device is intended for the rendering of video and audio signals, on a table-top, in a home or office environment. It must not be used in rooms with a high level of humidity or dust concentration. The warranty is only valid if used as intended by the manufacturer.



High humidity and dust concentration may lead to current leaks in the device. To reduce the risk of fire or electrical shock:

- Do not expose this device to rain, moisture, dripping or splashing water, and do not place objects filled with liquids, such as vases, cups, etc. on or over the device.
- Do not touch the device with wet hands.
- Do not expose to direct air-conditioning and keep candles or other naked flames away from the device at all times.

If the device is moved from a cold environment to a hot environment, leave it switched off for at least an hour to avoid condensation. If used outside, make sure it is protected from moisture.

If you notice anything unusual, immediately remove the power plug.

In case of fire, use preferably a CO₂ gas or powder fire extinguisher. If such extinguishers are not accessible, try to isolate the electrical supply before using a water fire extinguisher.

The device may fall, causing serious personal injury or death. Many injuries, particularly to children, can be avoided by taking simple precautions such as:

- ALWAYS use cabinets or stands or mounting methods recommended by the manufacturer of the device.
- ALWAYS use furniture that can safely support the device.

- ALWAYS ensure the device is not overhanging the edge of the supporting furniture.
- ALWAYS educate children about the dangers of climbing on furniture to reach the device or its controls.
- ALWAYS route cords and cables connected to your device so they cannot be tripped over, pulled or grabbed.
- NEVER place the device in an unstable location.
- NEVER place the device on tall furniture (for example, cupboards or bookcases) without anchoring both the furniture and device to a suitable support.
- NEVER place the device on cloth or other materials that may be located between the device and supporting furniture.
- NEVER place items that might tempt children to climb, such as toys and remote controls, on the top of the device or furniture on which the device is placed.

If your existing device is being retained and relocated, the same considerations as above should be applied.

■ Power Supply

Incorrect voltages can damage the device. Only connect this device to a power supply with the correct voltage and frequency noted on the type plate, using the supplied power cable.

The power plug must be easily accessible so that the device can be disconnected at all time. The device is live, even if in standby mode, as long as the device is connected to a power outlet.

It is recommended that this device is placed on a dedicated circuit.

- Do not overload the power outlets by connect too many appliances to the same outlet. Overloaded wall outlets, extension cords, etc. are dangerous and can result in electric shock and fire.

After power off, don't turn it on again in 5 seconds. Frequent switching power supply in a short period of time can cause abnormal device.

■ Power plug and power cable

- Do not touch the power plug with wet hands.
- Do not place heavy objects on the power cable. Route the cable so that it is not kinked or laid over sharp edges, walked on or exposed to chemicals. A power cable with damaged insulation can cause electric shock and fire.
- Pull the power plug, NOT on the cable when disconnecting. The cable can become damaged and cause a short circuit if pulled on.
- Do not place the power cable near a high temperature object.
- Do not move the device with the power cable plugged into a socket.
- Do not use a damaged or loose power cable, or a damaged socket outlet.
- Do not use any power cords other than the one supplied with this device.
- MAIN plug on the power cord is used as the disconnect device, the disconnect device and socket-outlet shall be easily accessible.

■ Air ventilation and high temperatures

Install your device only where there is proper ventilation, and ensure that there is at least 30 cm free space on the sides and 5 cm free space on the back unit for air circulation. Excessive heat and obstruction of ventilation could lead to fire or early failure of some electric components.

- Do not block any ventilation openings with newspapers, tablecloths, curtains, etc.
- Do not dry clothing etc. on top of the device.
- Take care not to touch the ventilation openings since they may become hot.
- Do not insert foreign objects into the device through the vents.

■ Warning about off-gassing

New furniture, carpet, paint, building materials and electronics can release chemicals into the air through evaporation. After you set your device up and turn it on for the first time, you may notice a slight smell within a couple of hours. This is because some components of device are heating up for the first time. The materials that we use fully meet the environmental requirements and regulations. Your device is working just fine and the fumes from the off-gassing will diminish eventually.

■ Supervision

- Do not let children play unsupervised close to the device. It could tip over, be pushed off or pulled down from the stand surface and injure someone.
- Do not allow a switched-on device to run unattended.

■ Volume

Loud music and noises can lead to irreparable damage to your ears. Extreme volumes should be avoided, especially during long-term exposure and when using headphones.

If you hear a drumming noise in your ears, turn down the volume or

temporarily stop using headphones.

■ Thunder Storms

Pull out the power plug from the device during a thunderstorm. Overvoltage caused by lightning strikes can damage the device via the wall socket.

■ Long periods of absence

As long as the power plug is connected to a live socket outlet, the device will consume power even in standby mode. The power plug should be disconnected during long periods of absence.

■ Cleaning and care

CAUTION:

Unplug the power cord prior to cleaning the device.

Clean the device, the screen, and the remote control with a soft, moist, clean and color-natural cloth only. Do not use any chemicals.

- Do not subject the surfaces to insect repellent, solvent, thinner or other volatile substances. This may degrade the surface quality.
- Do not spray water or other liquids directly on the device. Liquid inside the device could lead to product failure.
- Also wipe the power plug with a dry cloth at regular intervals.

■ Service/Repair

Never remove the cover/back of the device; there are no user serviceable parts inside. Refer all service to qualified service personnel.

■ Packaging

Keep the anti-moisture materials and plastic bags out of reach of children.

Plastic bags can cause suffocation and the anti-moisture material is harmful if swallowed. If swallowed by mistake, force the patient to vomit and visit the nearest hospital.

■ Modification

Do not attempt to modify this product in any way. Unauthorized modification could void the warranty of this unit, cause electric shock and fire.

■ Remote Control batteries

- Do not disassemble the product or attempt to remove the battery by yourself.
- Do not dispose it into fire.
- Do not crush or puncture the battery.
- Prevent it from falling down.
- Use the correct charging device.
- Be sure to dispose of battery correctly.
- Do not expose battery to excessive heat such as sunshine, fire or the like.

■ Disposal

Refer to the recycling section of this manual.

■ Laser

Do not look directly at the lens when this device is on because the laser light may damage your eyes!

- This product comes with a laser module. Do not tear or modify this device in any manner; otherwise, it may result in personal injury.

RG2

As with any bright light source, DO NOT STARE INTO THE BEAM IEC 62471-5: 2015

CLASS 1 LASER PRODUCT

$\lambda = 458-472\text{nm}/519-531\text{nm}/635-651\text{nm}$

Wavelength 458-472nm/519-531nm/635-651nm

CLASS 1 LASER PRODUCT IEC 60825-1: 2014

CAUTION:

Use of controls or adjustments or performance of procedures other than those specified herein may result in hazardous radiation exposure.

- If this device requires a repair, please wear laser eye protection with an optical density OD that is 4 or higher and has a wave length of 458-651nm.
- Do not place any water-containing vessel on this device, such as cosmetics or liquid medicine.
- If any object or water enters this device, please unplug this device and contact the service staff of Hisense.
- Do not place any exposed fire source (e.g. burning candle) on this device. Keep away from high temperature and heat.
- Do not expose the battery to direct sunlight or candle light.

- Keep air vents on both sides clear from any objects to prevent the device from overheating inside.
- To avoid a short circuit, product damage or electric shock, do not use any sharp object or metal to touch the ports or other openings on the device.
- If this device has been in a warm environment, allow any built-up condensation to evaporate first BEFORE you switch the device on.
- Do not allow a child to stand on or climb up this device.
- Do not place any object above or in front of the lens because the laser light could cause the object to become flammable.
- Clean the lens periodically with a clean cloth and make sure the device is turned off before you start.

Congratulations on the purchase of your new Laser Cinema! This Manual will walk you through a few easy steps to set up your Laser Cinema.

Please visit Hisense official website for more details.

Figures and illustrations are provided for reference only and may differ from actual product appearance.

Parts of the software function changes with the system upgrade.

Table of Contents

Accessories List	1
Laser Cinema Diagram	2
STEP 1. Mount the Screen	2
STEP 2. Install the Laser Cinema	2
STEP 3. Align the Projected Image	7
STEP 4. Use Your Remote	9
STEP 5. Proceed with the Screen Setup Menu	11
Maintenance & Troubleshooting	12
Product Specifications	14
Recycling / Licenses	15

Accessories List

- Laser Cinema × 1
- Remote control × 1
- Gloves for handling the Laser Cinema × 2
- Power cord × 1
- Laser Cinema User Manual × 1
- Laser Cinema European Guarantee × 1
- Cleaning kit for the lens × 1
- C-shape blocks × 2
- C-shaped Block Installing Instruction × 1

NOTE: The accessories list above may vary depending on specific model, country or region. Please refer to the actual accessory bag.

Laser Cinema Diagram

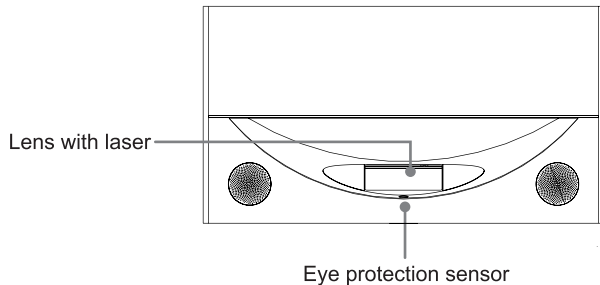
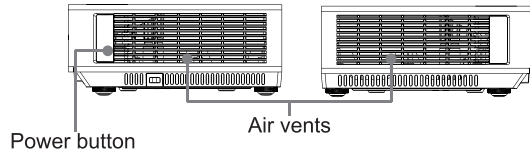
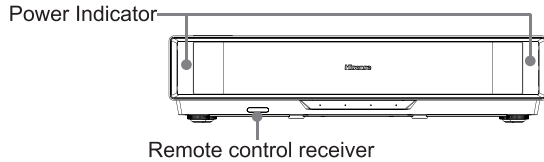

STEP 1 Mount the Screen

If you have purchased a screen, then refer to the specific screen installation guide.

STEP 2 Install the Laser Cinema

Be sure to protect the lens when you handle this device.

We recommend to connect all cables to the ports on the back of the Laser Cinema before positioning the Laser Cinema. (Audio, video, Ethernet cables and external devices are not included in the accessory bag.)

Check to ensure that you have selected the right cables for the ports and that they are connected securely. Loose connections can affect the quality of the picture image and colour.

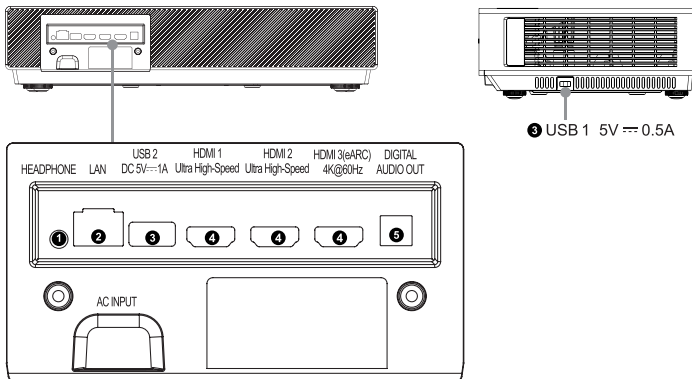

- For non-standard and large-capacity individual mobile hard disks, if the pulse current is larger than or equal to 1A, it may cause the device to restart or self-lock. The Laser Cinema is therefore not compatible with this type of drive.
- The voltage output of the USB is 5V.

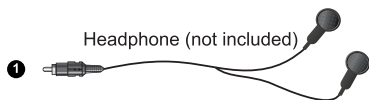

Headphone (not included)

1

- Excessive sound pressure from earphones and headphones can cause hearing loss.

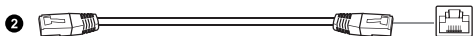

Ethernet (a router for Internet connection is needed)

2



3

NOTE:

- When connecting a hard disk or a USB hub, always connect the mains adapter of the connected device to the power supply. Exceeding a total current consumption may result in damage. The maximum current consumption of the USB 2.0 device is 500mA and the maximum current consumption of the USB 3.0 device is 1A.

External AV devices

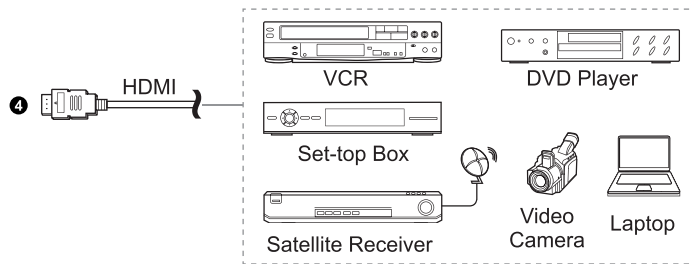

4

External audio devices

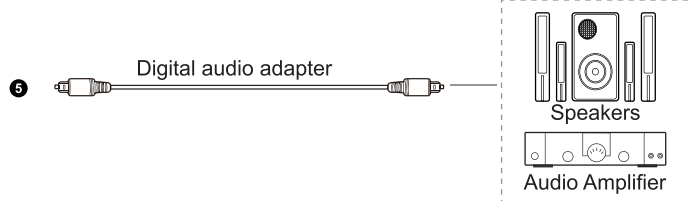

5

LAN (Wired setup)

- To connect your Laser Cinema to the network, connect the LAN port on the back of your Laser Cinema to an external modem or router using a LAN (Ethernet/Cat 5) cable. See the illustration below.

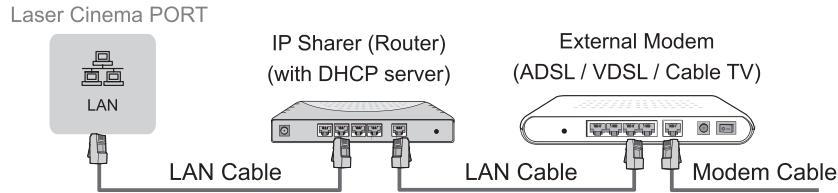

Wireless setup

- To connect your Laser Cinema to your network wirelessly, you need a wireless router or modem. See the illustration below.

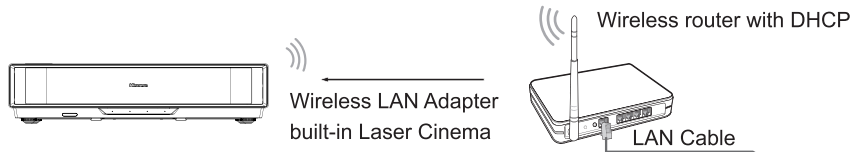

NOTE:

- You must use the built-in Wireless LAN Adapter to use a wireless network because the set doesn't support external USB network adapters.
- If the wireless router supports DHCP, your Laser Cinema can connect more easily to the wireless network.
- If you apply a security system other than the systems listed below, it will not work with the Laser Cinema.
Security system: WPA, WEP, WPA2, WPA3.
- In order to guarantee smooth network, the distance between router and Laser Cinema should be less than 10 metres.

Plug the power cord into a power socket.
Press the POWER button to switch on the device.

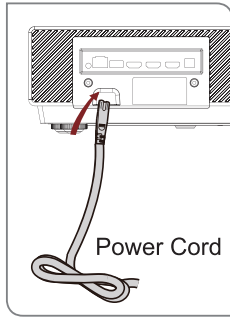

! WARNING: Poor ventilation will cause the device to overheat or become damaged.

- Do not block the ventilation openings or place any object on the device.
- Do not place the device in any narrow, enclosed or poorly ventilated space.

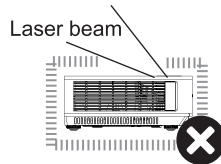

Ceiling installation

The device can be installed on the ceiling through the four threaded holes on the back of the device.

Please use a certified ceiling mount for the installation and ensure that four certified bolts of 6M×10mm are used to secure the device to the mount.

Only qualified professionals should perform the installation.

Using defective mounts or bolts, or improper installation, can result in personal injury or property damage.

The user shall assume full legal and financial responsibility for any personal injury, property damage, or consequential losses arising from:

- Use of non-certified installation materials
- Improper installation practices deviating from specifications
- Failure to implement safety measures

To ensure proper ventilation of the device, the minimum space must be maintained as shown in the diagram below.

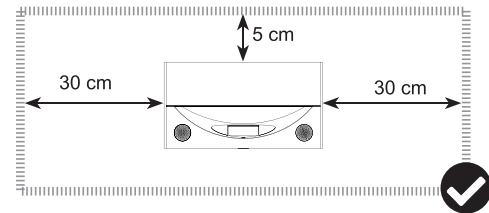
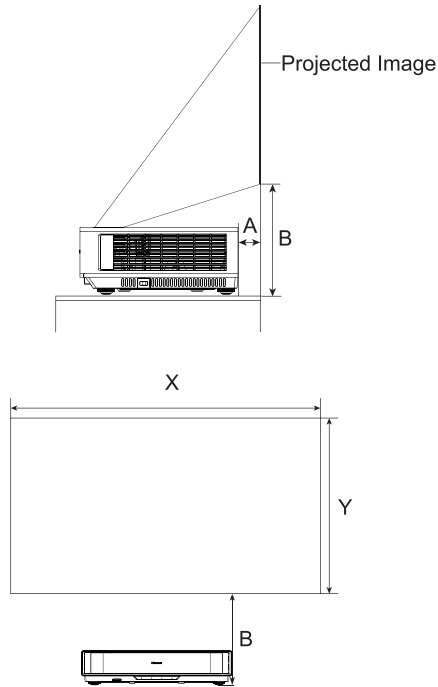

Image size and projection distance

NOTE: The sizes of the projected image for each projection distance may differ depending on the actual installation environment.



Projected Image Size (inch)	X(mm)	Y(mm)	A(mm)	B(mm)
80	1771	993	95	310
90	1993	1121	139	340
100	2214	1245	183	369
110	2435	1370	227	398
120	2657	1494	272	427
130	2878	1619	316	457
140	3100	1743	360	486
150	3321	1868	405	515

STEP 3 Align the Projected Image

- Follow the steps below, only if they apply to your situation.
- Adjust the height of the screen until the projected image is parallel with the screen.
- Rotate the feet with an overlooking view, and do not look directly at the lens when the console is on because the laser light may damage your eyes.

PARALLEL THE BOTTOM OF THE IMAGE WITH THE SCREEN

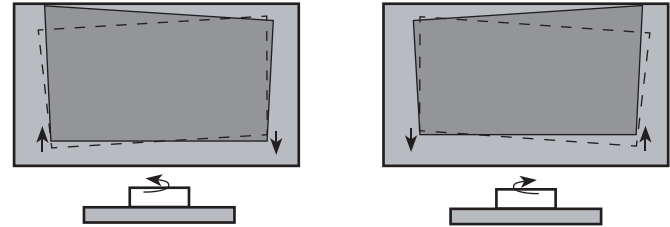

If the bottom of the image is lower on the left (right) and higher on the right (left), rotate the console counterclockwise (clockwise) until the bottom of the image is parallel with the screen.

FIT THE BOTTOM OF THE IMAGE TO THE SCREEN

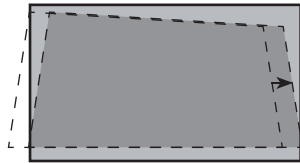

Move the console to the right

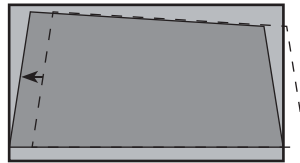

Move the console to the left

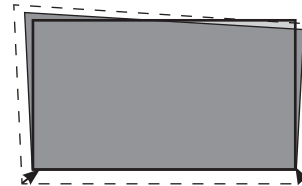

Move the console closer to the screen

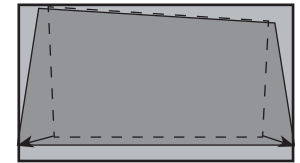

Move the console farther from the screen

ADJUST THE UPPER-RIGHT/UPPER-LEFT OF THE IMAGE

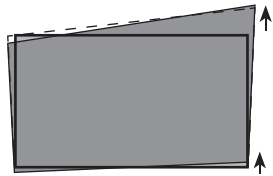

Rotate the front-right foot clockwise

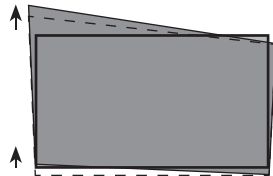

Rotate the front-left foot clockwise

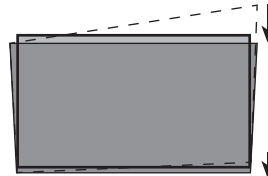

Rotate the console counterclockwise until the bottom of the image is parallel to the screen

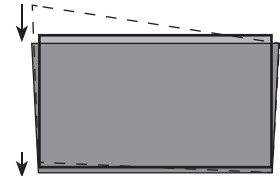

Rotate the console clockwise until the bottom of the image is parallel to the screen

FILL THE TOP OF THE IMAGE TO THE SCREEN



Rotate the left and right-front feet clockwise

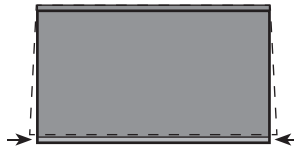











Rotate the left and right-back feet clockwise



Rotate the front feet counterclockwise if the back feet are already at their maximum height

STEP 4 Use Your Remote

BUTTONS ON YOUR LASER CINEMA REMOTE

BUTTON	DESCRIPTION
	Power on/Standby
	Input source selection
APP	Quick access to APPs
	Press to enter Menu
	Custom button, provides quick access to its user-defined function
Four colour buttons / 	Special function buttons
	D-pad (up/down/left/right navigation buttons)
OK	Confirm selection
	Under the Menu or App, return to the previous place
	Display the Home screen
EXIT	Exit the menu or exit the application
VOL	Volume (up/down)
	Brightness (up/down)
	Activate the microphone
	Mute and restore sound For some models, long press to be used as SUBTITLE



Playpad keys

Number button Input numbers

P.MODE Quick access to picture mode

S.MODE Quick access to sound mode

The following buttons are only for some live TV apps and may not be applicable in some models/countries/regions.

CH Switch channel

GUIDE Display the Electronic Program Guide
For some models, long press to be used as CH.LIST

TEXT Turn on/off the teletext function
For some models, long press to be used as INFO

CH.LIST Display the Channel List on the screen

INFO Display the current program information

SUBTITLE Activate or deactivate the subtitle mode

NOTE:

- Buttons listed here are for reference only. Actual remote control may vary depending on model, country/region.

CHARGING THE REMOTE CONTROL

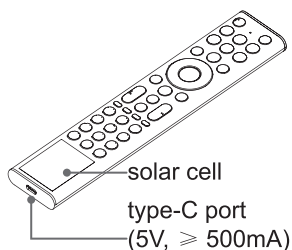

You can charge the remote by exposing the solar cell to light or using a USB type-C cable(not provided).

When charging by type-C port, the red indicator will blink. When fully charged, the indicator will stop blinking first and then turn off.

NOTE:

- Figures and illustrations are provided for reference only and may differ from actual product appearance.
- The battery is not user replaceable. Do not try to remove or change the internal battery by yourself, cause it may cause damage to the battery/device, personal injury, fire or explosion.
- When you do not use the remote control, place it face up to make the solar cell expose to light.
- Exposing the battery to environments with extremely high temperatures can result in explosion or the leakage of flammable liquid or gas.
- Battery chemicals can cause skin irritation. If chemicals come into contact with your skin, wash immediately.
- Disposal of a battery into fire or a hot oven, or mechanically crushing or cutting of a battery, that can result in an explosion.
- Always handle the remote control with care to prevent it from falling down.

- A battery subjected to extremely low air pressure that may result in an explosion or the leakage of flammable liquid or gas.

REMOTE CONTROL RANGE INFORMATION

- The remote control can work up to 8 metres in front of the Laser Cinema. (This distance is used for an unpaired infrared device.)
- Remote control angle: with the remote sensor as the highest point and 6 metres away, the horizontal control angle is within $\pm 30^\circ$, while the vertical angle is within $\pm 15^\circ$. (This distance is used for an unpaired infrared device.)

PAIRING THE REMOTE CONTROL (ONLY FOR BLUETOOTH REMOTE CONTROL)

Pair the remote to the Laser Cinema after the device is switched on. Keep the remote control within 3 metres from the Laser Cinema and press any button (except power and mic button) to pair.

NOTE:

- In special cases, press and hold [\equiv] button to pair.
- If an unknown error occurs with the remote control, it would be caused by interference. Try to eliminate the cause of the interference and pair it again.
- If an unknown error occurs with the remote control, please recharge and activate the remote control.
- The remote cannot be paired to the Laser Cinema with the Laser Cinema in standby mode.

STEP 5 Proceed with the Screen Setup Menu

PROJECTION MODE

If you need to flip the image over top-to-bottom and/or left-to-right, select the Projection Mode.

AUTO GEOMETRIC CORRECTION

1. Adjust the Laser Cinema position by using the levelling feet as needed, and ensure the frame of the screen is located inside the rectangular border.



2. Click Next to continue.
3. An auto-correction pattern will be displayed below, and the correction process will complete automatically.

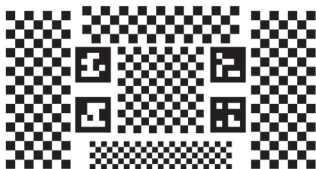

4. If the auto-correction results are unsatisfactory, use manual correction for fine-tuning.

NOTE:

- Obstacles between the host device and the screen, foreign objects on the screen surface, dark-colored walls, and strong ambient lighting may interfere with the automatic screen alignment. Ensure all obstacles and foreign objects are removed, use a lighter-colored wall, and minimize ambient light before initiating automatic screen alignment.
- This function is available only for screen of 100" and 120".
- Since screen type significantly impacts the performance of auto screen correction, we strongly recommend using the Hisense Ambient-Resisting Screen for optimal results.
- Manual correction may be required for fine-tuning if auto correction is unsatisfactory.

MANUAL GEOMETRIC CORRECTION

Select points and move it to fit the projected image into the screen.

1. Press $\wedge / \vee / \lt / \gt$ buttons on your remote control to move focus, and press **OK** button to choose a point you need to adjust.
2. Long press $\wedge / \vee / \lt / \gt$ buttons: quick adjustment of the projected image;
Short press $\wedge / \vee / \lt / \gt$ buttons: precise adjustment of the projected image.
3. Press \curvearrowright button to save your adjustment, and you can select other points to adjust the image.

If you want to return the image position to the factory default, select Reset on the screen.

EYE PROTECTION

In order to protect your eyes, keep the Eye Protection on, and do not look into the lens. If you get too close to the Laser Cinema, the light output will be temporarily disabled after 5 seconds.

FOCUS ADJUSTMENT

You can adjust the focus parameters by pressing the up and down buttons on the remote. The focus effect is adjusted in real time according to the displayed background image card.

Maintenance

- Avoid touching the device when it is running or immediately after it is turned off, as it may be hot.
- Do not clean the device with oil-based products as they can deteriorate the exterior or damage the paint. Extended contact with rubber or ethylene products can cause stains on the device.
- If the exterior of the Laser Cinema becomes dirty, turn off the device and wipe it with a damp, soft cloth.
- **Lens Care:**
 - Avoid touching the lens with your hands.
 - Do not use ordinary cleaning cloths to wipe the lens.

- Use a dust blower to remove dust from the lens.
- For grease, dirt, and fingerprints, have a professional clean the lens using optical cleaning cloths, lens wiping paper, or professional cleaning solutions to avoid damaging the optical coating and affecting image quality.
- Always use the Power button on the remote control to turn off the device. Do not cut off the power directly while the device is operating.

Troubleshooting

If you are having trouble with your device, first try turning it off and on again. If this does not fix the problem, check the tips in the following.

It takes a few seconds before the picture is displayed after the device is switched on. Is this normal?

Yes, this is normal. The Laser Cinema is in the process of initialisation and searching for information on previous settings.

No sound or no picture

1. Check if the power cord is plugged into a working mains socket.
2. Press the  Power button on the remote control to activate the device from 'Standby' mode.
3. Check if the power indicator is lit or not. If it is, then the Laser Cinema is powered.

No picture and/or sound after connection to an external source

1. Check if the output connection of the external source and the input connection of the Laser Cinema are correct.
2. Make sure you have made the correct selection for the input mode of the incoming signal.

Picture is normal but there is no sound

1. Check the volume settings.
2. Check if 'Mute' mode is activated.

Sound is normal but there is no picture or only a black and white picture

1. If the picture is black and white, unplug the device from the power socket and re-plug it after 60 seconds.
2. Check if the Colour Saturation is set to 50 or higher.
3. Try different sources.

Sound and/or Picture are distorted or appear wavy

1. An electric appliance may be affecting the Laser Cinema.
Turn off any appliances nearby and move it farther away from the Laser Cinema.
2. Insert the power plug of the Laser Cinema into another power socket.

The plastic housing is emitting a clicking sound

Temperature changes during operation may cause the device

to slightly expand or shrink, which may cause a clicking sound. This is normal and the device is in perfect working order.

The remote control does not work

1. Ensure that the device is connected to the mains socket and can be operated.
2. Please recharge and activate the remote control.

Product Specifications

Model Name	Laser Cinema	
Dimension (L × D × H)	20.5 × 11.1 × 4.7 inches (521 × 282 × 119 mm)	
Weight	15.9 lbs (7.2 kg)	
Active Screen Size (Diagonal)	80 ~ 150 inches	
Screen resolution	3840 × 2160	
Audio power	2 × 15 W + 2 × 8 W	
Power consumption	200 W	
Power supply	120-240V ~ 50/60Hz	
Wireless LAN Module specifications	Frequency Range	2.4-2.4835GHz 5.15-5.85GHz 5.9-6.425GHz
	Output Power (Max.)	2.4-2.4835GHz 17dBm 5.15-5.25GHz 14dBm 5.25-5.35GHz(DFS Band) 14dBm 5.49-5.71GHz(DFS/TPC Band) 14dBm 5.725-5.85GHz(for Non EU) 14dBm 5.9-6.425GHz 14dBm

Disclaimer: All products, product specifications, and data are subject to change without notice to improve reliability, function, design or otherwise.

Bluetooth Module specifications	Frequency Range	2.4-2.4835GHz
	Output Power (Max.)	2.4-2.4835GHz, Class1, 6dBm
Environmental conditions		Temperature: 41°F - 104°F (5°C - 40°C) Humidity: 20% - 80% RH Atmospheric pressure: 86 kPa - 106 kPa
HDMI Input		RGB / 60Hz (640×480, 800×600, 1024×768) YUV / 60Hz (480i, 480p, 720p, 1080i, 1080p) YUV / 50Hz (576i, 720p, 1080i, 1080p) 3840×2160 / 24Hz, 3840×2160 / 25Hz, 3840×2160 / 30Hz, 3840×2160 / 50Hz, 3840×2160 / 60Hz
Network Standby Power Consumption		≤ 2.0 W
Power Consumption in Standby Mode		≤ 0.5 W
WIFI		IEEE 802.11 a/b/g/n/ac/ax
Bluetooth		BT5.3

THIS PRODUCT IS LICENSED UNDER THE AVC PATENT PORTFOLIO LICENSE FOR THE PERSONAL USE OF A CONSUMER OR OTHER USES IN WHICH IT DOES NOT RECEIVE REMUNERATION TO (i) ENCODE VIDEO IN COMPLIANCE WITH THE AVC STANDARD ("AVC VIDEO") AND/OR (ii) DECODE AVC VIDEO THAT WAS ENCODED BY A CONSUMER ENGAGED IN A PERSONAL ACTIVITY AND/OR WAS OBTAINED FROM A VIDEO PROVIDER LICENSED TO PROVIDE AVC VIDEO. NO LICENSE IS GRANTED OR SHALL BE IMPLIED FOR ANY OTHER USE. ADDITIONAL INFORMATION MAY BE OBTAINED FROM MPEG LA, L.L.C. SEE [HTTP://WWW.MPEGLA.COM](http://www.mpegla.com)

Recycling / Licenses

WEEE (Waste Electronic Electric Equipment) European Directive 2012/19/EU



This symbol on the product or on its packaging indicates that this product must not be disposed of with your household waste. Instead, it is your responsibility to dispose of your waste equipment by handing it over to a designated collection point for the recycling of waste electrical and electronic equipment. The separate collection and recycling of your waste equipment at the time of disposal will help to conserve natural resources and ensure that it is recycled in a manner that protects human health and the environment. For more information about where you can drop off your waste equipment for recycling, please contact your local city office, your household waste disposal service or the shop where you purchased the product.

Batteries



In accordance with the Battery Directive, the battery in this product should not be disposed of in the domestic waste. The built-in battery in this product is not user replaceable, please contact your service provider for more information. Dispose the product to waste disposal service and they will take appropriate measures for the recycling and treatment.

ROHS (Restriction of Hazardous Substance) European Directive 2011/65/EU



This European directive limits the use of dangerous and hazardous substances which are difficult to recycle.

This allows recycling easily the EEE and contributes to the safeguard of the environment.

Substances included in this product match to the RoHS directive.



Hereby, Hisense Visual Technology Co., Ltd. declares that the radio equipment type is in compliance with Directive 2014/53/EU and Radio Equipment Regulations 2017 of UK. Please enter the model name at the following internet address to read the full text of the declaration of conformity: <https://global.hisense.com/support/certificate-download/>.

Please refer to the rating label for model name and find Bluetooth remote control model name on the remote control or inside the remote control cover.

EU Conformity Statement



This product and - If applicable - the supplied accessories too are marked with "CE" and comply therefore with the applicable harmonized European standards listed under the EMC Directive 2014/30/EU, the LVD Directive 2014/35/EU, the RoHS Directive 2011/65/EU.



The terms HDMI, HDMI High-Definition Multimedia Interface, HDMI Trade dress and the HDMI Logos are trademarks or registered trademarks of HDMI Licensing Administrator, Inc.



Dolby, Dolby Vision, Dolby Atmos, and the double-D symbol are registered trademarks of Dolby Laboratories Licensing Corporation. Manufactured under license from Dolby Laboratories. Confidential unpublished works. Copyright © 2012–2024 Dolby Laboratories. All rights reserved.



FOR DTS PATENTS, SEE [HTTP://XPERI.COM/DTS-PATENTS/](http://xperi.com/dts-patents/). MANUFACTURED UNDER LICENSE FROM DTS, INC. AND ITS AFFILIATES. DTS, DTS:X, THE DTS:X LOGO, VIRTUAL:X, AND THE DTS VIRTUAL:X LOGO ARE REGISTERED TRADEMARKS OR TRADEMARKS OF DTS, INC. AND ITS AFFILIATES IN THE UNITED STATES AND/OR OTHER COUNTRIES. © DTS, INC. AND ITS AFFILIATES. ALL RIGHTS RESERVED.



Manufactured under license from IMAX Corporation. IMAX® is a registered trademark of IMAX Corporation in the United States and/or other countries. For DTS patents, see <http://patents.dts.com>. Manufactured under license from DTS Licensing Limited. DTS and the DTS logo are registered trademarks or trademarks of DTS, Inc. in the United States and other countries. © 2020 DTS, Inc. ALL RIGHTS RESERVED.

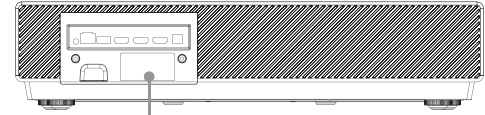
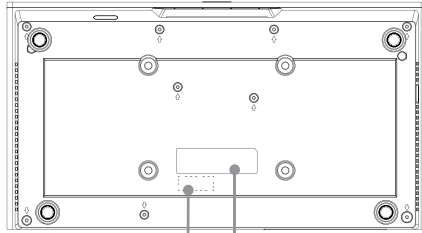

CAUTION
MISE EN GARDE
CLASS 1 LASER PRODUCT
CONSUMER LASER PRODUCT
RG2
DO NOT STARE INTO THE BEAM
NE PAS REGARDER DANS LE FAISCEAU APPAREIL À LASER DE
APPAREIL À LASER DE CLASSE 1

IEC 60825-1:2014 EN 60689:2021
 CAN/CSA-E60825-1:15 EN 60825-1:2014+A11:2021

The Device Complies with 21 CFR 1346.33 and 1346.31 except for conformance as a Risk Group 2 LP as defined in IEC 62471-3:6.1.3. For more information see Laser Notice "Ln57", dated May 9, 2023.

WARNING: This set must not be opened unless by a qualified technician.
WARNING: Dieses Set darf nur von einem qualifizierten Techniker geöffnet werden.
VAROVÁNÍ: Toto zařízení nesmí být otevřeno, pokud není otevřeno kvalifikovanými technikými.
VAROVANIE: Toto zariadenie nechvárajte, pokiaľ nemáte kvalifikovaného technika.
AVERTIZARE: Nu deschideți acest echipament decât dacă aveți un tehnician calificat.
OPAZORILO: Teaga kompleta ne smeje odpirati, odprati ga sme samo uopozobljeni tehnik.
UPOZORENJE: Ovaj se uređaj ne smije otvoriti ako ga nije otvorio kvalificirani tehničar.
ΠΡΟΕΙΔΟΠΟΙΗΣΗ: Μην ανοίξετε τη συσκευή εκτός αν το ανοίξει από ειδικευμένο τεχνικό.
OSTREZENIE: Nie otwieraj tego urządzenia bez wykwalifikowanego technika.
AVERTISSEMENT: Cet ensemble ne doit être démonté que par un technicien qualifié.
ATTENZIONE: Non aprire la unità a meno che non sia stato eseguito da un tecnico qualificato.
ADVERTENCIA: Este conjunto no debe abrirse a menos que lo haga un técnico calificado.
AVISO: Este conjunto não pode ser aberto a menos que por um técnico qualificado.
ПРЕДУПРЕЖДЕНИЕ: Тояа устрóйство не трябва да се отваря, освен ако не е отворено от квалифицирани техници.
FIGYELEM: Csak akkor nyissa ki ezt az eszközt, ha képzett szakembertl rendelkezik.
WAARSCHUWING: Deze set mag niet worden geopend, alleen door een gekwalificeerde technicus.

CAUTION
 RISK OF ELECTRICAL SHOCK
 DO NOT OPEN

Hisense LASER CINEMA

MADE IN CHINA



1419426 ES-A2507Z6-1