

Refrigerator

User manual

Free Standing Appliance

SAMSUNG



Contents

Safety information	4
What you need to know about the safety instructions	4
Important safety symbols and precautions:	6
Important safety precautions	7
Severe warning signs for transportation and site	10
Critical installation warnings	11
Installation cautions	14
Critical usage warnings	15
Usage cautions	20
Cleaning cautions	23
Critical disposal warnings	25
Additional tips for proper usage	26
Instructions about the WEEE	27
Installation	28
Refrigerator at a glance	29
Step-by-step installation	31
Operations	37
Main panel	37
SmartThings (applicable models only)	41
SMART GRID Function (Demand Response) (applicable models only)	44
Special features	47
Maintenance	50
Door reversal (applicable models only)	50
Handle and care	63
Cleaning	69
Replacement	70
Troubleshooting	71
General	71
Do you hear abnormal sounds from the refrigerator?	73
SmartThings (applicable models only)	75
Appendix	76
Safety Instruction	76
Install Instruction	76
Temperature Instruction	77
Information for model and ordering spare parts	80



Open Source Announcement

81

Contents

Safety information

Before using your new Samsung Refrigerator, please read this manual thoroughly to ensure that you know how to operate the features and functions that your new appliance offers safely and efficiently.

What you need to know about the safety instructions

- Warnings and Important Safety Instructions in this manual do not cover all possible conditions and situations that may occur.
It is your responsibility to use common sense, caution, and care when installing, maintaining, and operating your appliance.
- Because these following operating instructions cover various models, the characteristics of your refrigerator may differ slightly from those described in this manual and not all warning signs may be applicable. If you have any questions or concerns, contact your nearest service center or find help and information online at www.samsung.com.
- R-600a or R-134a is used as a refrigerant. Check the compressor label on the rear of the appliance or the rating label inside the fridge to see which refrigerant is used for your appliance. When this product contains flammable gas (Refrigerant R-600a), contact your local authority in regard to safe disposal of this product.
- In order to avoid the creation of a flammable gas-air mixture if a leak in the refrigerating circuit occurs, the size of the room in which the appliance may be sited depends on the amount of refrigerant used.

-
- Never start up an appliance showing any signs of damage. If in doubt, consult your dealer. The room must be 1 m³ in size for every 8 g of R-600a refrigerant inside the appliance.

The amount of refrigerant in your particular appliance is shown on the identification plate inside the appliance.

- Refrigerant squirting out of the pipes could ignite or cause an eye injury. When refrigerant leaks from the pipe, avoid any naked flames and move anything flammable away from the product and ventilate the room immediately.
 - Failing to do so may result in fire or explosion.
- To avoid contamination of food, please respect the following instructions:
 - Opening the door for long periods can cause a significant increase of the temperature in the compartments of the appliance.
 - Clean regularly surfaces that can come in contact with food and accessible drainage systems.
 - Clean water tanks if they have not been used for 48 h; flush the water system connected to a water supply if water has not been drawn for 5 days.
 - Store raw meat and fish in suitable containers in the refrigerator, so that it is not in contact with or drip onto other food.
 - Two-star frozen-food compartments are suitable for storing pre-frozen food, storing or making icecream and making ice cubes.
 - One-, two- and three-star compartments are not suitable for the freezing of fresh food.



Safety information

- If the refrigerating appliance is left empty for long periods, switch off, defrost, clean, dry, and leave the door open to prevent mould developing within the appliance.

Important safety symbols and precautions:

Please follow all safety instructions in this manual. This manual uses the following safety symbols.

WARNING

Hazards or unsafe practices that may result in **severe personal injury, property damage, and/or death.**

CAUTION

Hazards or unsafe practices that may result in **severe personal injury and/or property damage.**

NOTE

Useful information that helps users understand or benefit from the refrigerator.

These warning signs are here to prevent injury to you and others.

Please follow them carefully.

After reading this section, keep it in a safe place for future reference.



Important safety precautions



Warning; Risk of fire / flammable materials

WARNING

- When positioning the appliance, ensure the supply cord is not trapped or damaged.
- Do not locate multiple portable socket-outlets or portable power supplies at the rear of the appliance.
- Fill with potable water only.
- Connect to potable water supply only.
- Keep ventilation openings, in the appliance enclosure or in the built-in structure, clear of obstruction.
- Do not use mechanical devices or any other means to accelerate the defrosting process, other than those recommended by the manufacturer.
- Do not damage the refrigerant circuit.
- Do not use electrical appliances inside the food storage compartments of the appliance, unless they are of the type recommended by the manufacturer.
- This appliance is not intended for use by persons (including children) with reduced physical, sensory, or mental capabilities, or those who lack experience and knowledge, unless they have been given supervision or instruction concerning the use of the appliance by a person responsible for their safety.



Safety information

- This appliance can be used by children aged from 8 years and above and persons with reduced physical, sensory or mental capabilities or lack of experience and knowledge if they have been given supervision or instruction concerning use of the appliance in a safe way and understand the hazards involved. Children shall not play with the appliance. Cleaning and user maintenance shall not be made by children without supervision. Children aged from 3 to 8 years are allowed to load and unload refrigerating appliances.
- If the supply cord is damaged, it must be replaced by the manufacturer, its service agent or similarly qualified persons in order to avoid a hazard.
- The socket must be easily accessible so that the appliance can be quickly disconnected from the supply in an emergency.
 - It must be outside the area of the rear of the appliance.
- Do not store explosive substances such as aerosol cans with a flammable propellant in this appliance.
- If the product is equipped with LED lamps, do not disassemble the Lamp Covers and LED lamps yourself.
 - Contact a Samsung service center.
 - Use only the LED Lamps provided by the manufacturer or its service agents.
- For the most efficient use of energy, please keep the all inner fittings such as baskets, drawers, shelves on the position supplied by manufacturer.
- To get the best energy efficiency of this product, please leave all shelves, drawers and baskets on their original position.



How to minimize the energy consumption

- Install the appliance in a cool, dry room with adequate ventilation.
- Ensure that it is not exposed to direct sunlight and never put it near a direct source of heat (radiator, for example).
 - Not to block any vents or grilles is recommended for energy efficiency.
 - Allow warm food to cool down before placing it in the appliance.
 - Put frozen food in the refrigerator to thaw. You can then use the low temperatures of the frozen products to cool food in the refrigerator.
 - Do not keep the door of the appliance open for too long when putting food in or taking food out.
 - The shorter time for which the door is open, the less ice will form in the freezer.
 - Clean the rear of the refrigerator regularly. Dust increases energy consumption.
 - Do not set temperature colder than necessary.
 - Ensure sufficient air exhaust at the refrigerator base and at the back wall of the refrigerator. Do not cover air vent openings.
 - Allow clearance to the right, left, back and top when installing. This will help reduce power consumption and keep your energy bills lower.
- We recommend the value of clearance to be :
 - Right, left, and back side: more than 50 mm
 - Top side: more than 100 mm

Safety information

This appliance is intended to be used in household and similar applications such as

- staff kitchen areas in shops, offices and other working environments;
- farm houses and by clients in hotels, motels and other residential type environments;
- bed and breakfast type environments;
- catering and similar non-retail applications.

Severe warning signs for transportation and site

WARNING

- When transporting and installing the appliance, care should be taken to ensure that no parts of the refrigerating circuit are damaged.
 - Refrigerant leaking from the pipe work could ignite or cause an eye injury. If a leak is detected, avoid any naked flames or potential sources of ignition and air the room in which the appliance is standing for several minutes.
 - This appliance contains a small amount of isobutane refrigerant (R-600a), a natural gas with high environmental compatibility that is, however, also combustible. When transporting and installing the appliance, care should be taken to ensure that no parts of the refrigerating circuit are damaged.

Critical installation warnings

WARNING

- Do not install the refrigerator in a damp location or place where it may come in contact with water.
 - Deteriorated insulation on electrical parts may cause an electric shock or fire.
- Do not place this refrigerator in direct sunlight or expose it to the heat from stoves, room heaters, or other appliances.
- Do not plug several appliances into the same multiple power strip. The refrigerator should always be plugged into its own individual electrical outlet which has a voltage rating that matches the voltage listed on the refrigerator's rating plate.
 - This provides the best performance and also prevents overloading of house wiring circuits, which could cause a fire hazard from overheated wires.
- If the wall socket is loose, do not insert the power plug.
 - There is a risk of electric shock or fire.
- Do not use a power cord that has cracks or abrasion damage along its length or at either end.
- Do not bend the power cord excessively or place heavy objects on it.
- Do not pull or excessively bend the power cord.
- Do not twist or tie the power cord.
- Do not hook the power cord over a metal object, place a heavy object on the power cord, insert the power cord between objects, or push the power cord into the space behind the appliance.

Safety information

- When moving the refrigerator, be careful not to roll over or damage the power cord.
 - This may result in an electric shock or fire.
- Never unplug your refrigerator by pulling on the power cord. Always grip the plug firmly and pull straight out from the outlet.
 - Damage to the cord may cause a short-circuit, fire, and/or electric shock.
- Do not use aerosols near the refrigerator.
 - Using aerosols near the refrigerator may cause an explosion or fire.
- Do not install this appliance near a heater or inflammable material.
- Do not install this appliance in a location where gas may leak.
 - This may result in an electric shock or fire.
- This refrigerator must be properly located and installed in accordance with the instructions in this manual before you use it.
- Connect the power plug in the proper position with the cord hanging down.
 - If you connect the power plug upside down, the wire can get cut off and cause a fire or electric shock.
- Make sure that the power plug is not crushed or damaged by the back of the refrigerator.
- Keep the packing materials out of reach of children.
 - There is a risk of death from suffocation if a child puts the packing materials on his or her head.

- Do not install this appliance in a humid, oily or dusty location, in a location exposed to direct sunlight and water (rain drops).
 - Deteriorated insulation of electrical parts may cause an electric shock or fire.
- If any dust or water is in the refrigerator, pull out power plug and contact your Samsung Electronics service center.
 - Otherwise there is a risk of fire.
- Do not stand on top of the appliance or place objects (such as laundry, lighted candles, lighted cigarettes, dishes, chemicals, metal objects, etc.) on the appliance.
 - This may result in an electric shock, fire, problems with the product, or injury.
- You need to remove all the protective plastic film before you initially plug the product in.
- Children should be supervised to ensure that they do not play with the snap rings used for door adjustment or the water tube clips.
 - There is risk of death by suffocation if a child swallows a snap ring or water tube clip. Keep the snap rings and water tube clips out of children's reach.
- The refrigerator must be safely grounded.
 - Always make sure that you have grounded the refrigerator before attempting to investigate or repair any part of the appliance. Power leakages can cause severe electric shock.

Safety information

- Never use gas pipes, telephone lines, or other potential lightning attractors as an electrical ground.
 - You must ground the refrigerator to prevent any power leakages or electric shocks caused by current leakage from the refrigerator.
 - This may result in an electric shock, fire, explosion, or problems with the product.
- Plug the power plug into the wall socket firmly. Do not use a damaged power plug, damaged power cord, or loose wall socket.
 - This may result in an electric shock or fire.
- The fuse on the refrigerator must be changed by a qualified technician or service company.
 - Failing to do so may result in an electric shock or personal injury.

Installation cautions

CAUTION

- Allow sufficient space around the refrigerator and install it on a flat surface.
 - If your refrigerator is not level, cooling efficiency and durability can be declined.
- Allow the appliance to stand for 2-3 hours before loading foods after installation and turning on.
- We strongly recommend you have a qualified technician or service company install the refrigerator.
 - Failing to do so may result in an electric shock, fire, explosion, problems with the product, or injury.

Critical usage warnings

WARNING

- Do not insert the power plug into a wall socket with wet hands.
 - This may result in an electric shock.
- Do not store articles on the top of the appliance.
 - When you open or close the door, the articles may fall and cause personal injury and/or material damage.
- Do not insert hands, feet or metal objects (such as chopsticks, etc.) into the bottom or the back of the refrigerator.
 - This may result in an electric shock or injury.
 - Any sharp edges may cause a personal injury.
- Do not touch the inside walls of the freezer or products stored in the freezer with wet hands.
 - This may cause frostbite.
- Do not put a container filled with water on the refrigerator.
 - If spilled, there is a risk of fire or electric shock.
- Do not keep volatile or flammable objects or substances (benzene, thinner, propane gas, alcohol, ether, LP gas, and other such products) in the refrigerator.
 - This refrigerator is for storing food only.
 - This may result in fire or explosion.
- Children should be supervised to ensure that they do not play with the appliance.
 - Keep fingers out of “pinch point” areas. Clearances between the doors and cabinet are necessarily small. Be careful when you open the doors if children are in the area.

Safety information

- Do not put your fingers or children's fingers between the doors.
 - Keep fingers out of the left and right door gaps. Be careful when you open the doors if your fingers are in between the doors.
- Do not let children hang on the door or door bins. A serious injury may occur.
- Do not let children go inside the refrigerator. They could become trapped.
- Do not insert your hands into the bottom area under the appliance.
 - Any sharp edges may cause personal injury.
- Do not store pharmaceutical products, scientific materials, or temperature sensitive products in the refrigerator.
 - Products that require strict temperature controls must not be stored in the refrigerator.
- If you smell pharmaceutical or smoke, pull out power plug immediately and contact your Samsung Electronics service center.
- If any dust or water is in Refrigerator, pull out power plug and contact your Samsung Electronics service center.
 - Otherwise there is a risk of fire.
- Do not let children step on a drawer.
 - The drawer may break and cause them to slip.
- Do not leave the doors of the refrigerator open while the refrigerator is unattended and do not let children enter inside the refrigerator.
- Do not allow babies or children go inside the drawer.
 - It can cause death from suffocation by entrapment or personal injury.

-
- Do not overfill the refrigerator with food.
 - When you open the door, an item may fall out and cause personal injury or material damage.
 - Do not spray volatile material such as insecticide onto the surface of the appliance.
 - As well as being harmful to humans, it may also result in an electric shock, fire, or problems with the product.
 - Never put fingers or other objects into the water dispenser hole, ice chute and ice maker bucket.
 - It may cause a personal injury or material damage.
 - Do not use or place any substances sensitive to temperature such as flammable sprays, flammable objects, dry ice, medicine, or chemicals near or inside of the refrigerator.
 - Do not use a hair dryer to dry the inside of the refrigerator. Do not place a lighted candle in the refrigerator for removing bad odours.
 - This may result in an electric shock or fire.
 - Fill the water tank, ice tray and water cubes only with potable water (mineral water or purified water).
 - Do not fill the tank with tea, juice or sports drink, this may damage the refrigerator.
 - Do not stand on top of the appliance or place objects (such as laundry, lighted candles, lighted cigarettes, dishes, chemicals, metal objects, etc.) on the appliance. This may result in an electric shock, fire, problems with the product, or injury. Do not put a container filled with water on the appliance.
 - If spilled, there is a risk of fire or electric shock.

Safety information

- Never stare directly at the UV LED lamp for long periods of time.
 - This may result in eye strain due to the ultraviolet rays.
- Do not put shelf in upside down. Shelf stopper could not work.
 - It may cause a personal injury because of glass shelf drop.
- Keep fingers out of “pinch point” areas. Clearances between the doors and cabinet are necessarily small. Be careful when you open the doors if children are in the area.
- If a gas leak is detected, avoid any naked flames or potential sources of ignition, and air the room in which the appliance is standing for several minutes.
 - Do not touch the appliance or power cord.
 - Do not use a ventilating fan.
 - A spark may result in explosion or fire.
- Bottles should be stored tightly together so that they do not fall out.
- This product is intended only for the storage of food in a domestic environment.
- Never put fingers or other objects into the water dispenser hole, ice chute and ice maker bucket.
 - It may cause a personal injury or material damage.
- Do not attempt to repair, disassemble, or modify the refrigerator yourself.
- Do not use any fuse (such as cooper, steel wire, etc.) other than a standard fuse.

-
- If your refrigerator needs to be repaired or reinstalled, contact your nearest service center.
 - Failing to do so may result in an electric shock, fire, problems with the product, or injury.
 - If the refrigerator emits a burning smell or smoke, unplug the refrigerator immediately and contact your Samsung Electronics service center.
 - Failing to do so may result in an electric or fire hazards.
 - Pull the power plug out of the socket before changing the interior lamps of the refrigerator.
 - Otherwise, there is a risk of electric shock.
 - If you experience difficulty changing a non-LED light, contact a Samsung service center.
 - Plug the power plug into the wall socket firmly.
 - Do not use a damaged power plug, damaged power cord or loose wall socket.
 - This may result in an electric shock or fire.

Safety information

Usage cautions

CAUTION

- Do not refreeze thawed food.
 - Frozen and thawed food will develop harmful bacteria faster than fresh.
 - The second thaw will break down even more cells, leaching out moisture and changing the integrity of the product.
- Do not thaw meat at room temperature.
 - Safety will depend on whether the raw product was handled properly.
- Do not place glass bottles or carbonated beverages into the freezer.
 - The container may freeze and break, and this may result in injury.
- Use only the ice maker provided with the refrigerator.
- If you will be away from home for a long period of time (on vacation, for example) and won't be using the water or ice dispensers, close the water valve.
 - Otherwise, water leakage may occur.
- If you won't be using the refrigerator for a very long period of time, (3 weeks or more) empty the refrigerator including the ice bucket, unplug it, close the water valve, wipe excess moisture from the inside walls, and leave the doors open to prevent odors and mold.
- To get the best performance from the product:
 - Do not place food too close to the vents at the rear of the refrigerator as this can obstruct free air circulation in the refrigerator compartment.

-
- Wrap food up properly or place it in airtight containers before putting it into the refrigerator.
 - Please observe maximum storage times and expiration dates of frozen goods.
 - There is no need to disconnect the refrigerator from the power supply if you will be away for less than three weeks. However, if you will be away for more than three weeks, remove all the food and ice in the ice bucket, unplug the refrigerator, close the water valve, wipe excess moisture from the inside walls, and leave the doors open to prevent odors and mold.
 - Service Warranty and Modification.
 - Any changes or modifications performed by a 3rd party on this finished appliance are not covered under Samsung warranty service, nor is Samsung responsible for safety issues that result from 3rd party modifications.
 - Do not block the air vents inside the refrigerator.
 - If the air vents are blocked, especially with a plastic bag, the refrigerator can be over cooled. If a cooling period lasts too long, the water filter may break and cause water leakage.
 - Use only the ice-maker provided with the refrigerator.
 - Wipe excess moisture from the inside and leave the doors open.
 - Otherwise, odor and mold may develop.
 - If the refrigerator is disconnected from the power supply, you should wait for at least five minutes before plugging it back in.

Safety information

- When the refrigerator got wet by water, pull out the power plug and contact your Samsung Electronics service center.
- Do not strike or apply excessive force to any glass surface.
 - Broken glass may result in a personal injury and/or property damage.
- Fill the water tank and ice cube trays with potable water only (tap water, mineral water, or purified water).
 - Do not fill the tank with tea or a sports drink. This may damage the refrigerator.
- Be careful that your fingers are not caught in.
- If the refrigerator is flooded, make sure to contact your nearest service center.
 - There is a risk of electric shock or fire.
- Do not keep vegetable oil in your refrigerator's door bins. The oil can solidify, making it foul-tasting and difficult to use. In addition, the open container can leak and the leaked oil can cause the door bin to crack. After opening an oil container, it is best to keep the container in a cool and shaded place such as a cupboard or pantry.
 - Examples of vegetable oil: olive oil, corn oil, grape-seed oil, etc.

Cleaning cautions

CAUTION

- Do not spray water directly on the inside or outside the refrigerator.
 - There is a risk of fire or electric shock.
- Do not use a hair dryer to dry the inside of the refrigerator.
- Do not place a lighted candle in the refrigerator to remove bad odors.
 - This may result in an electric shock or fire.
- Do not spray cleaning products directly on the display.
 - Printed letters on the display may come off.
- If any foreign substance such as water has entered the appliance, unplug the power plug and contact your nearest service center.
 - Failing to do so may result in an electric shock or fire.
- Use a clean, dry cloth to remove any foreign matter or dust from the power plug blades. Do not use a wet or damp cloth when cleaning the plug.
 - Otherwise, there is a risk of fire or electric shock.
- Do not clean the appliance by spraying water directly onto it.
- Do not use benzene, thinner, or Clorox, Chloride for cleaning.
 - They may damage the surface of the appliance and may cause a fire.
- Never put fingers or other objects into the dispenser hole.
 - It may cause a personal injury or material damage.

Safety information

- Before cleaning or performing maintenance, unplug the appliance from the wall socket.
 - Failing to do so may result in an electric shock or fire.
- Use a clean sponge or soft cloth and a mild detergent in warm water to clean the refrigerator.
- Do not use abrasive or harsh cleansers such as window sprays, scouring cleansers, flammable fluids, muriatic acid, cleaning waxes, concentrated detergents, bleaches, or cleansers containing petroleum products on exterior surfaces (doors and cabinet), plastic parts, door and interior liners, and gaskets.
 - These can scratch or damage the material.
- Do not clean glass shelves or covers with warm water when they are cold. Glass shelves and covers may break if exposed to sudden temperature changes or impacts such as bumping or dropping.

Critical disposal warnings

WARNING

- Please dispose of the packaging material from this product in an environmentally friendly manner.
- Ensure that none of the pipes on the back of the refrigerator are damaged prior to disposal.
- R-600a or R-134a is used as a refrigerant. Check the compressor label on the rear of the appliance or the rating label inside the fridge to see which refrigerant is used for your refrigerator. If this refrigerator contains flammable gas (Refrigerant R-600a), contact your local authority in regard to safe disposal of this product.
- When disposing of this refrigerator, remove the door/door seals and door latch so that small children or animals cannot become trapped inside. Children should be supervised to ensure that they do not play with the appliance. If trapped inside, a child may get hurt or suffocate to death.
 - If trapped inside, the child may become injury and suffocate to death.
- Cyclopentane is used in the insulation. The gases in the insulation material require a special disposal procedure. Please contact your local authorities in regard to the environmentally safe disposal of this product.
- Keep all packaging materials well out of the reach of children, as packaging materials can be dangerous to children.
 - If a child places a bag over his or her head, the child could suffocate.

Safety information

Additional tips for proper usage

- In the event of a power failure, call the local office of your electric company and ask how long the failure is going to last.
 - Most power failures that are corrected in an hour or two will not affect your refrigerator temperatures. However, you should minimize the number of door openings while the power is off.
 - Should the power failure last more than 24 hours, remove and discard all frozen food.
- The refrigerator might not operate consistently (frozen contents can thaw or temperatures can become too warm in the frozen food compartment) if sited for an extended period of time in a location where ambient air temperatures are constantly below the temperatures for which the appliance is designed.
- In case of particular foods, keeping it under refrigeration can have a bad effect on preservation due to its properties.
- Your appliance is frost free, which means there is no need to manually defrost your appliance. This will be carried out automatically.
- Temperature rise during defrosting complies with ISO requirements. If you want to prevent an undue rise in the temperature of frozen food while the appliance defrosts, wrap the frozen food in several layers of newspaper.
- Do not re-freeze frozen foods that have thawed completely.

Instructions about the WEEE



Correct Disposal of This Product (Waste Electrical & Electronic Equipment) (Applicable in countries with separate collection systems)

This marking on the product, accessories or literature indicates that the product and its electronic accessories (e.g. charger, headset, USB cable) should not be disposed of with other household waste at the end of their working life. To prevent possible harm to the environment or human health from uncontrolled waste disposal, please separate these items from other types of waste and recycle them responsibly to promote the sustainable reuse of material resources.

Household users should contact either the retailer where they purchased this product, or their local government office, for details of where and how they can take these items for environmentally safe recycling.

Business users should contact their supplier and check the terms and conditions of the purchase contract. This product and its electronic accessories should not be mixed with other commercial wastes for disposal.

For information on Samsung's environmental commitments and product regulatory obligations, e.g. REACH, WEEE or Batteries, visit our sustainability page available via www.samsung.com

(For products sold in European countries and in the UK only)

Installation

Follow these instructions carefully to ensure a proper installation of this refrigerator and to prevent accidents before using it.

 **WARNING**

- Use the refrigerator only for its intended purpose as described in this manual.
- Any servicing must be performed by a qualified technician.
- Dispose of the product packaging material in compliance with the local regulations.
- To prevent electric shock, unplug the power cord before servicing or replacements.

Refrigerator at a glance

The actual image and provided parts of the refrigerator may differ, depending on the model and the country.

Normal type

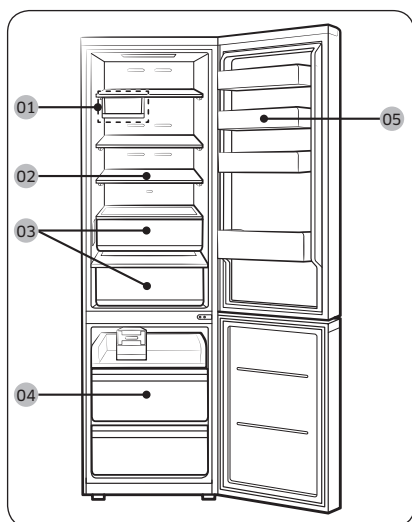

Dispenser type

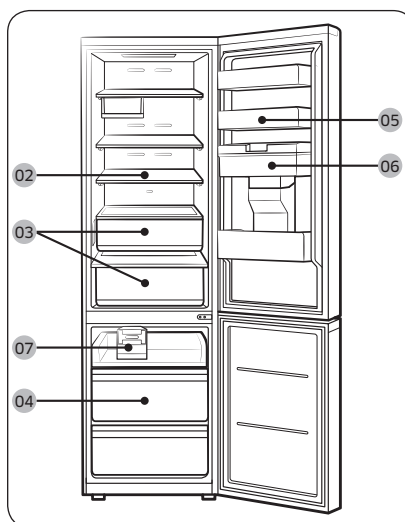

01 Multi tray *

02 Fridge shelf /
Foldable shelf *

03 Vegetable Drawer *

04 Freezer drawer

05 Fridge door bin

06 Water tank **

07 Twist ice maker *

* applicable models only

** dispenser type models only

Installation

NOTE

- For best energy efficiency, make sure all of shelves, drawers, and baskets are placed in their original position.
- To get more space, you can remove all the drawers and locate the 'Freezer Shelf (applicable models only)' on the bottom drawer in freezer, since it does not affect thermal and mechanical characteristics. A declared storage volume of frozen food storage compartment is calculated with these drawers removed.

Door bins

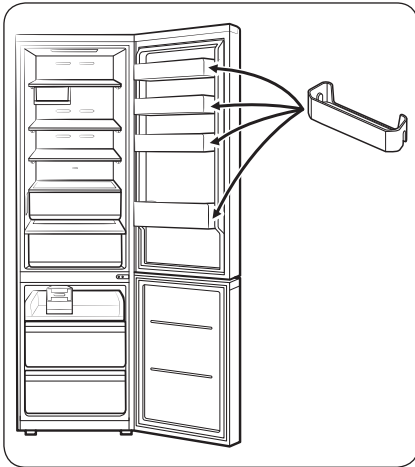

Your refrigerator ships with door bins of different types and sizes. If the door bins for your refrigerator were packaged separately, assemble them in the correct position according to the figure.

NOTE

The actual refrigerator and provided component parts of your refrigerator may differ from the illustrations in this manual, depending on the model and the country.

Step-by-step installation

STEP 1 Select a site

Site requirements:

- Solid, level surface without carpeting or flooring that may obstruct ventilation
- Away from direct sunlight
- Adequate room for opening and closing the door
- Away from a heat source
- Room for maintenance and servicing
- Temperature range: between 10 °C and 43 °C

Clearance

See the following figures and tables for space requirements for installation.

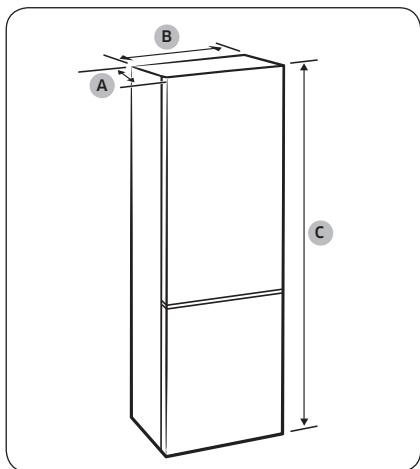

Model	RB45**	RB50**	RB53**
Depth "A"	711		
Width "B"	759		
Overall Height "C"	1780	1920	2030

(unit : mm)

Installation

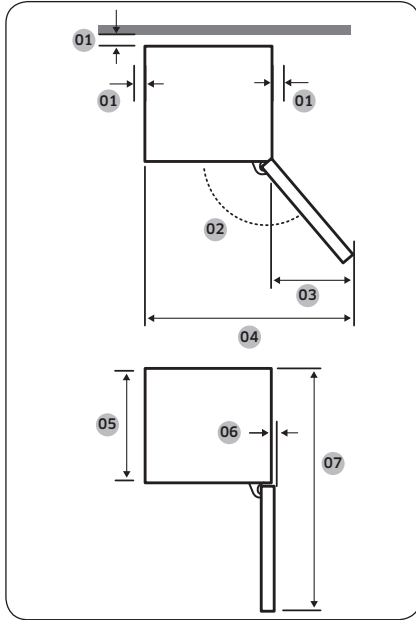

01	more than 50 mm recommended
02	Fridge : 115°, Freezer : 120°
03	551
04	1307
05	626
06	32
07	1406

(unit : mm)

Installation

NOTE

The measurements in the table may differ, depending on the measuring method.



STEP 2 Spacing (applicable models only)

NOTE

The number of provided spacers varies on the model. Attach all the provided spacers.

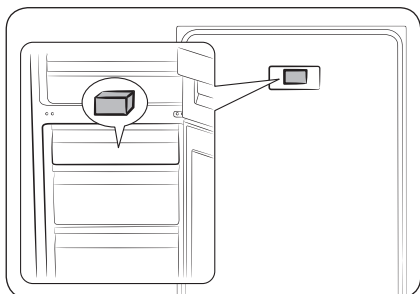

1. Open the door and locate the provided spacer (Gray block).
2. Unpack the spacer and attach it to the rear of the refrigerator as shown. They help ventilate air to the rear wall and save power consumption.

STEP 3 Flooring

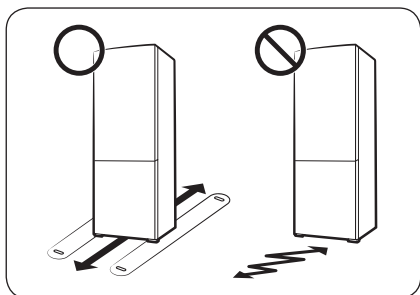

- The surface to install the refrigerator must support a fully loaded refrigerator.
- To protect the floor, put a large piece of cardboard on each foot of the refrigerator.
- Once the refrigerator is in its final position, do not move it unless necessary to protect the floor. If you have to, use a thick paper or cloth such as old carpet along the movement path.



Installation

STEP 4 Adjust the levelling legs

⚠ CAUTION

- The refrigerator must be levelled on a flat, solid floor. Failing to do so can cause damage to the refrigerator or physical injury.
- Levelling must be performed with an empty refrigerator. Make sure no food items remain inside the refrigerator.
- For safety reasons, adjust the front side a little higher than the rear side.

The refrigerator can be levelled using the front legs that have a special screw (leveller) for levelling purposes. Use a flat-head screwdriver for levelling.

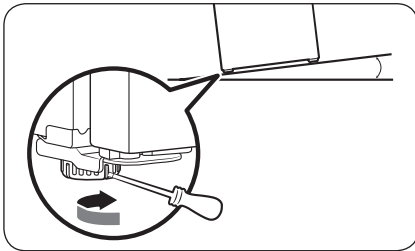

To adjust the height of the left side:

Insert a flat-head screwdriver into the leveller of the front left leg. Turn the leveller clockwise to raise, or turn it anticlockwise to lower.

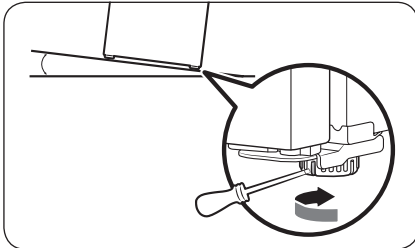

To adjust the height of the right side:

Insert a flat-head screwdriver into the leveller of the front right leg. Turn the leveller clockwise to raise, or turn it anticlockwise to lower.



STEP 5 Unpack and assemble the multi tray (applicable models only)

For shipping and safety purposes, the multi tray is packed and stored in the freezer drawer. Unpack the multi tray and assemble it beneath the fridge shelf.

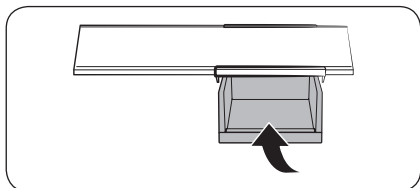

- Insert the multi tray into the sliding rail beneath the top fridge shelf.

STEP 6 Initial settings

By completing the following steps, the refrigerator should be fully functioning.

1. Remove the PE foam sheet on each shelf corner, which is attached to protect the refrigerator during transportation.
2. Plug the power cord into the wall socket to turn the refrigerator on.
3. Open the door, and check if the interior light lights up.
4. Set the temperature to the coldest, and wait for about an hour. Then, the refrigerator will be slightly chilled, and the motor will run smoothly.
5. Wait until the refrigerator reaches the set temperature. Now the refrigerator is ready for use.

NOTE

When the refrigerator powers on, the alarm will sound. To turn off the alarm, tap <, ○ or >.



Installation

STEP 7 Temperature Alarm

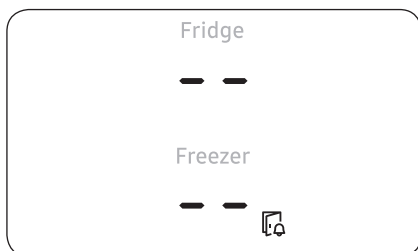

- If the freezer temperature is too warm because there has been a power failure, the display blinks as shown in the figure.
 - If you tap any button (<, ○, or >), the "warmest temperature" which has reached in the freezer and fridge compartment is flashed on the display for 5 seconds.
- This warning may occur;
 - When the appliance is turned on for the first time after the installation.
 - If the freezer is too warm due to a power failure.

STEP 8 Final check

When installation is complete, confirm that:

- The refrigerator is plugged into an electrical outlet and grounded properly.
- The refrigerator is installed on a flat, level surface with a reasonable clearance from the wall or the cabinet.
- The refrigerator is level and is sitting firmly on the floor.
- The door opens and closes freely, and the interior light turns on automatically when you open the door.

Operations

Main panel

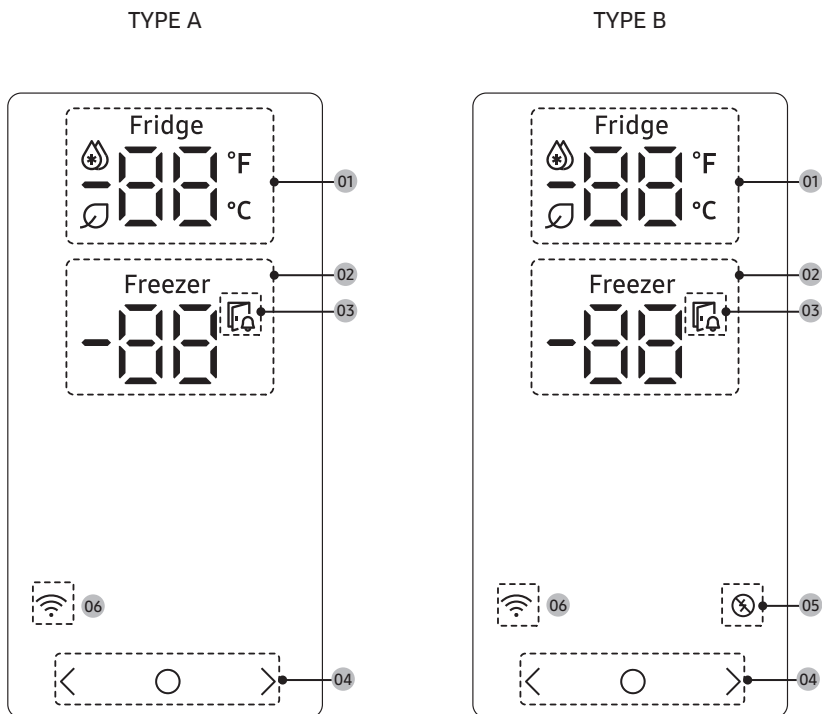

01 Fridge indicator	<ul style="list-style-type: none"> Displays the current or desired temperature of the fridge. ☰ indicates that the Power Cool function is on. The 🌿 icon appears if you turn on the AI Energy Mode in the SmartThings app. (applicable models only)
02 Freezer indicator	<ul style="list-style-type: none"> Displays the current or desired temperature of the freezer. ❄️ indicates that the Power Freeze function is on.
03 Door open indicator	This indicator blinks with an alarm if the door is left open for more than 2 minutes.

Operations

04 Buttons	<ul style="list-style-type: none">• When the display is off, tap any button to wake up the display.• Use  to select the fridge or freezer and < or > to select the desired temperature or function for the selected compartment.
05 Peak Demand indicator *	<ul style="list-style-type: none">• Displays the status of the Peak Demand function.• For more information on the Peak Demand function, see the SMART GRID Function (Demand Response) (applicable models only) section.
06 Network connection indicator	<ul style="list-style-type: none">• This icon indicates that the refrigerator is connected to a network. If the Wi-Fi icon flashes, we recommend connecting your refrigerator with the SmartThings app. You can control and monitor your refrigerator on the SmartThings app. For more information, see the SmartThings (applicable models only) section.

NOTE

If the door is left open for 5 minutes, internal light will blink for 5 minutes and turn off. This is to alert hearing-impaired users that a door is open. Note that this function is normal.



Setting the desired temperature or function

1. Tap any button (< , ○ , or >) to wake up the display.
 - This step may not apply to some models.
2. Tap ○ to select the fridge or freezer.
 - The selected compartment's indicator blinks.
3. Tap < or > to select the desired temperature or function.
 - Refer to the table for available selection for each compartment.

Fridge	<ul style="list-style-type: none"> • Available selection in Celsius: (Power Cool) ↔ 1 °C ↔ 2 °C ↔ 3 °C ↔ 4 °C ↔ 5 °C ↔ 6 °C ↔ 7 °C ↔ (Vacation) • Available selection in Fahrenheit (applicable models only): (Power Cool) ↔ 34 °F ↔ 35 °F ↔ 36 °F ↔ 37 °F ↔ 38 °F ↔ 39 °F ↔ 40 °F ↔ 41 °F ↔ 42 °F ↔ 43 °F ↔ 44 °F ↔ (Vacation) • Power Cool speeds up the cooling process at maximum fan speed. The fridge keeps running at full speed for two and a half hours and then returns to the previous temperature. • Use the Vacation function if you are going on vacation or a business trip, or if you do not intend to use the fridge for an extended time. The fridge temperature will be kept under 17 °C, but the freezer remains active as previously set.
Freezer	<ul style="list-style-type: none"> • Available selection in Celsius: (Power Freeze) ↔ -23 °C ↔ -22 °C ↔ -21 °C ↔ -20 °C ↔ -19 °C ↔ -18 °C ↔ -17 °C ↔ -16 °C ↔ -15 °C • Available selection in Fahrenheit (applicable models only): (Power Freeze) ↔ -8 °F ↔ -7 °F ↔ -6 °F ↔ -5 °F ↔ -4 °F ↔ -3 °F ↔ -2 °F ↔ -1 °F ↔ 0 °F ↔ 1 °F ↔ 2 °F ↔ 3 °F ↔ 4 °F ↔ 5 °F • Power Freeze speeds up the freezing process at maximum fan speed. The freezer keeps running at full speed for 50 hours and then returns to the previous temperature. To freeze large amounts of food, activate Power Freeze for at least 20 hours before putting food in the freezer. <p> NOTE When you use this function the energy consumption of the refrigerator will increase. Remember to turn it off when you don't need it and return the freezer to your original temperature setting.</p>

4. Wait until the selected compartment's indicator stops blinking or tap ○ to confirm your selection.

NOTE

Using Power Cool or Power Freeze increases power consumption.



Operations

Turning on or off the Wi-Fi (applicable models only)

To turn the Wi-Fi on or off, tap and hold > for 10 seconds. The display shows the status of Wi-Fi for 5 seconds (as shown in the figure).

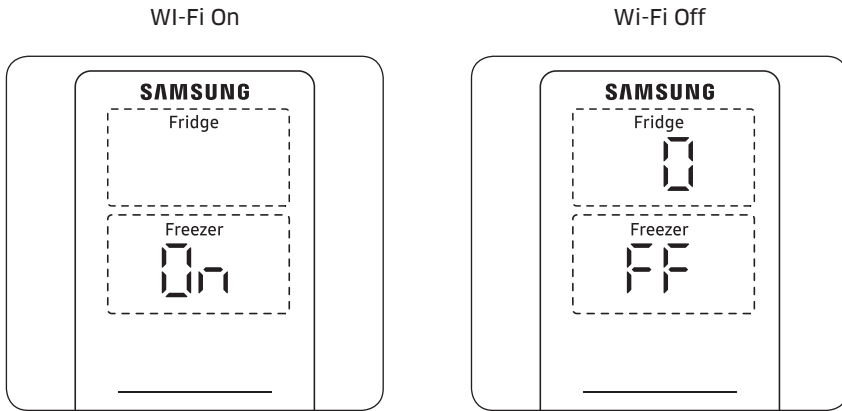

NOTE

- When you setup the Wi-Fi to connect the refrigerator to the SmartThings app, Wi-Fi On/Off functions turns on.
- For more information, see the **SmartThings (applicable models only)** section.

Changing the temperature scale (applicable models only)

You can switch the temperature scale between Fahrenheit and Celsius.

1. Tap any button (<, ○, or >) to wake up the display.
 - This step may not apply to some models.
2. Tap ○ until the °F and °C symbols on the fridge or freezer blink.
3. Tap < or > to select the desired temperature scale.
 - Tap < to select Fahrenheit.
 - Tap > to select Celsius.
4. Wait for 5 seconds or tap ○ to confirm your selection.
 - The °F and °C symbols stop blinking.

SmartThings (applicable models only)

Installation

Visit the Google Play Store, Galaxy Apps, or Apple App Store and search for “SmartThings”. Download and install the SmartThings app provided by Samsung Electronics to your smart device.

NOTE

- The supporting software version of the SmartThings app is subject to change according to the OS supporting policy the manufacturer provides. In addition, as for the SmartThings app or the functions that the app supports, the new application update policy on the existing OS version can be suspended due to usability or security reasons.
- The SmartThings app is subject to change without notice to improve usability or performance. As the mobile phone OS version is updated every year, the SmartThings is also updated continually according to the latest OS. If you have enquiries regarding the items mentioned above, please contact us on st.service@samsung.com
- Recommended encryption systems include WPA/TKIP and WPA2/AES. Any newer or non-standard Wi-Fi authentication protocols are not supported.
- Wireless networks may be affected by the surrounding wireless communication environment.
- If your Internet service provider has registered the MAC address of your PC or modem for identification, your Samsung Smart Refrigerator may fail to connect to the Internet. If this happens, contact your Internet service provider for technical assistance.
- The firewall settings of your network system may prevent your Samsung Smart Refrigerator from accessing the Internet. Contact your Internet service provider for technical assistance. If this symptom continues, contact a local Samsung service center or retailer.
- To configure the wireless access point (AP) settings, see the user manual of the AP (router).
- Samsung Smart Refrigerators support both Wi-Fi 2.4 GHz with IEEE 802.11 b/g/n and Soft-AP protocols. (IEEE 802.11 n is recommended.)
- Unauthorized Wi-Fi wireless routers may fail to connect to applicable Samsung Smart Refrigerators.

Operations

Samsung account

You are required to register your Samsung account to use the app. If you don't have a Samsung account, follow the app's onscreen instructions to create a free Samsung account.

Getting started

Turn on the device you want to connect, open the SmartThings app on your phone, and then follow the instructions below.

If a pop-up appears saying that a new device has been found, tap **ADD NOW**.

If a pop-up doesn't appear, tap the **+** button, and then select the device you want to connect from the list of available devices.

If your device isn't in the list of available devices, tap **Supported Devices**, select the device type (Refrigerator), and then select the specific device model.

Follow the instructions in the app to set up your device. Once setup is complete, your refrigerator will appear as a "card" on your **Devices** screen.

Integrated control

You can monitor and control your refrigerator at home and on the go.

- Tap the refrigerator icon on the SmartThings Dashboard or tap the Devices icon at the bottom of the Dashboard, and then tap the refrigerator "card" to open the Refrigerator page.
- Check the operation status or notifications related to your refrigerator, and then change options or settings if necessary.

NOTE

Some options or settings of the refrigerator may not be available for remote control.

Category	Item	Description
Monitoring	Fridge temperature	Displays the current temperature setting of the fridge.
	Freezer temperature	Displays the current temperature setting of the freezer.
Functions	Power Cool	You can turn Power Cool on or off, and check the current settings.
	Power Freeze	You can turn Power Freeze on or off, and check the current settings.
	Fridge temperature	You can set the desired temperature of the fridge.
	Freezer temperature	You can set the desired temperature of the freezer.
Alarms	Abnormally high temperature	This alarm is triggered when the fridge or freezer has abnormally high temperatures.
	Door opening	This alarm is triggered if the door is open for more than 2 minutes.
AI Energy Mode (applicable models only)	<p>You can turn on or off the AI Energy Mode under the Energy menu in the SmartThings app.</p> <p>You can check the status of the AI Energy Mode on the SmartThings app.</p> <p>On some models, the  icon appears on the main panel to indicate that AI Energy Mode is operating. (applicable models only)</p> <p>Turning on the AI Energy Mode decreases energy consumption, but it may also reduce the cooling performance.</p>	

Operations

SMART GRID Function (Demand Response) (applicable models only)

When the refrigerator operates in SMART GRID (Demand Response) mode, the Energy Management Refrigerator function can control energy usage or delay the operation of some functions to save money when energy prices or demand are the highest.

NOTE

- You can deactivate the SMART GRID (Demand Response) function at any time using the Peak Demand Off function.
- To use the SMART GRID (Demand Response) function, you need a separate contract with your electric utility company.

In addition, to use the Smart Grid (Demand Response) function, you must register for the service with your electric company. The company must have an EMS (Energy Management System) that supports SEP (Smart Energy profile).

Using the SMART GRID (Demand Response) Function

This feature monitors energy prices and demand information from your utility company and sends notifications to the refrigerator to run high energy consuming tasks during off-peak times when electricity costs and demand are lower.

If the refrigerator receives a control signal from the utility company, the refrigerator will display the **DAL** (L3) ~ **TALR** (L4) levels on the refrigerator display and control the power consumption according to the level.

[Exception condition] The **DAL** and **TALR** control signals from a utility company work as long as product performance is maintained.

If the refrigerator receives the SMART GRID (Demand Response) signal (**DAL** or **TALR**), the refrigerator will operate in Delay Appliance Load (Display:L3) or Temporary Appliance Load Reduction (Display:L4) mode.



- Delay Appliance Load (L3): The refrigerator responds to a **DAL** signal by providing a moderate load reduction for the duration of the delay period. This function controls functions that consume a lot of energy such as adjusting the Cooling system, running the defrost cycle, and making ice.
 - When the refrigerator operates in **DAL** (L3) mode, "L3" is displayed on the refrigerator display.
 - **DAL** mode is automatically deactivated after it lasts for the amount of time stipulated by the **DAL** signal (max. 4.5 hours) or when the Peak Demand Off key is pressed.
- Temporary Appliance Load Reduction (L4): The refrigerator responds to a **TALR** signal by aggressively reducing the load for a short time period. This function reduces energy consumption by stopping the compressor and controlling the functions that consume a lot of energy such as the defrost cycle and making ice.
 - When the refrigerator operates in **TALR** (L4) mode, "L4" is displayed on the refrigerator display.
 - **TALR** (L4) mode is automatically deactivated after it lasts for the received duration (max. 15 minutes), or when the Peak Demand Off key is pressed. The mode is immediately deactivated and the refrigerator returns to the normal state when the door is opened or closed, or the dispenser is used.

Peak Demand Off (Override mode)

When you want the refrigerator to ignore the SMART GRID (Demand Response) signal from the utility company, you can activate Peak Demand Off (Override mode).

When you activate Peak Demand Off (Override mode), the refrigerator ignores the SMART GRID (Demand Response) signal and is not controlled by the utility company.

Activating and deactivating Peak Demand Off (Override mode)

1. To activate/deactivate Peak Demand Off (Override mode), Press the < button for 3 seconds, while not changing other display settings.
2. When the Peak Demand Off function is deactivated, if you press < button for 3 seconds the Peak Demand Off function will be activated.
 - The corresponding indicator () turns on.
 - If the refrigerator receives a SMART GRID (Demand Response) signal from the utility company, 'Or' is displayed in the fridge indicator.
3. When the Peak Demand Off function is activated, if you press < button for 3 seconds the Peak Demand Off function will be deactivated.
 - The corresponding indicator () turns off.

Operations

Using the Energy Management Function

The Energy Management function enables you to control and monitor your Energy Management refrigerator using the SmartThings app for your convenience.

NOTE

- To use the Energy Management refrigerator functions, you have to install the corresponding app first.
1. Operational Status
 - You can check the DR and Peak Demand Off (Override mode) status.
 2. Energy Consumption Reporting
 - Shows the accumulated power consumption. Power consumption data is updated every 10 minutes.

NOTE

The energy consumption report may differ from the power consumption specifications of the product depending on the operating environment and the stored food.

3. Delay Defrost Capability
 - The Delay Defrost Capability function saves energy by delaying the defrost operation to a time specified by the user. You can configure the time, and this function will save energy during the specified period in a 24 hour cycle. If the time is not set, the function works with the default time settings. The default time settings are below:
 - 6 am to 10 am: 1st. November ~ 30th. April
 - 3 pm to 7 pm: 1st. May ~ 31th. October

To change the time setting for the Delay Defrost Capability

You can change the time setting for the Delay Defrost Capability on the app.

Provision for Open Access to the Connected Product Requirements

1. SGIP Open Standards (Smart Energy Profile 2.0 - <http://www.csep.org/>)
 - Energy Consumption Reporting
 - Demand Response
2. Samsung OPEN API
 - Operational Status, User Settings & Messages
 - ICE Maker Status: GET /icemaker/status/vs/0
 - Door Open Alarm: GET /doors/vs/0
 - DR Status: GET /drlc/vs/0
 - Delay Defrost Capability
 - Set Schedule of the Defrost Delay: POST /defrost/reservation/vs/0?op=add
 - Get Schedule of the Defrost Delay : GET /defrost/reservation/vs/0
 - Delete Schedule of the Defrost Delay: POST /defrost/reservation/vs/0?op=remove
 - Defrost Delay On/OFF: POST /defrost/delay/vs/0

Special features

The actual image and special functions of your refrigerator may differ, depending on the model and the country.

Water dispenser (applicable models only)

With the water dispenser, you can dispense water without opening the fridge door. The water tank must be filled with potable water before use.

To fill the water tank with potable water

Open the fridge door and locate the water tank on the door bin area.

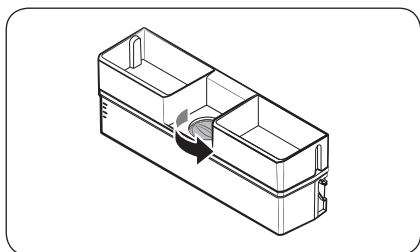

1. Remove the top cap.

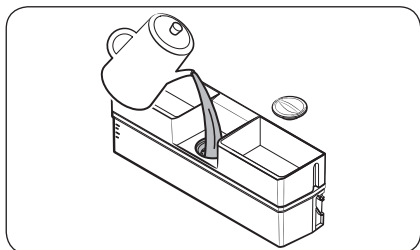

2. Fill the water tank with potable water up to 3.5 liters (MAX).

⚠ CAUTION

- The water dispenser is designed to dispense potable water. Fill the water tank only with potable water. Do not fill with any other liquids.
- Do not fill the water tank excessively, which causes an overflow.

📖 NOTE

For first-time use, clean inside the water tank.

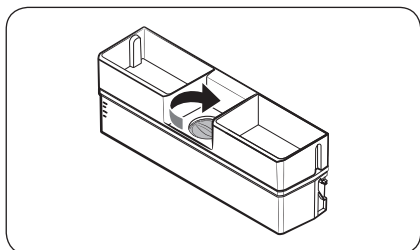

3. Close the top cap.

Operations

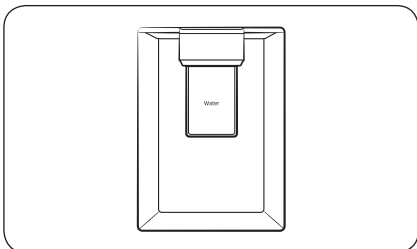

4. Put a water glass under the water outlet of the dispenser, and gently push the dispenser lever to dispense water.

CAUTION

- Do not store items on top of the water tank cap.
- Do not try to fill the water tank without removing it from the door.
- Make sure that water tank is seated properly.
- Do not use the refrigerator without the water tank. This may reduce performance and efficiency.
- To prevent water bouncing, make sure the glass is in line with the dispenser lever.

NOTE

To secure more room, you can use the water tank to store food. In this case, remove the lid of the tank.

Ice making (applicable models only)

Twist ice maker

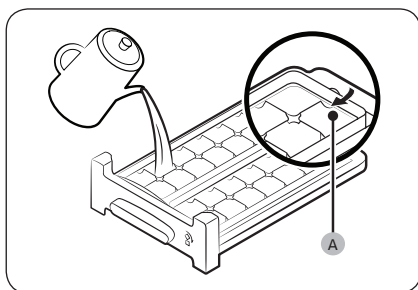

1. Open the freezer door, and slide open the ice tray.
2. Fill the tray with water up to the maximum level (A) marked on the inner rear of the tray.
3. Slide the tray back into position.

NOTE

The ice making time depends on your temperature settings.

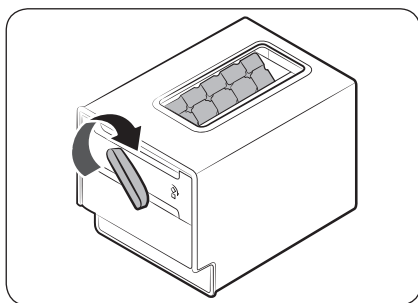

NOTE

- Make sure the ice cube storage bin is in place under the ice tray.
- To dispense the ice cubes, turn the handle of the bin to the right to empty half of the ice cubes into the bin. Then, turn it to the left to empty the other half.
- Take out the bin by slightly twisting and pulling to the front.

Maintenance

Door reversal (applicable models only)

Reversing the door must be performed by Samsung-approved servicing personnel at your own expense because this kind of servicing is not covered by the Warranty.

⚠ WARNING

- Reversing failure or property damage that may occur by unapproved agencies will not be covered by the Warranty.
- Make sure that the refrigerator is disconnected from the power source before doing the reversal.
- You must wait for at least an hour after door reversing is complete. This is to prevent electric shock that could occur.

Tools required (not provided)

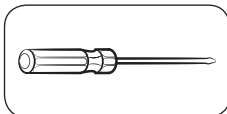

Phillips screwdriver

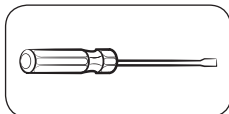

Flat-head screwdriver



11 mm spanner
(for hinge shaft)

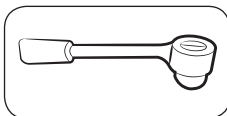

8 mm socket wrench
(for bolts)

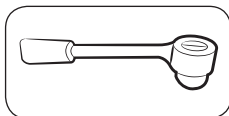

10 mm socket wrench
(for bolts)

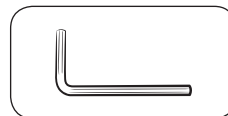

5 mm Allen wrench
(for middle hinge)

Accessories

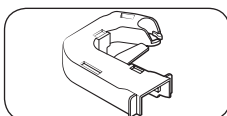

Hinge Cover (L)

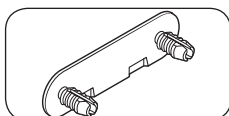

Middle-Hinge Screw cap

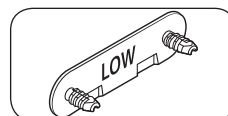

Bottom-Hinge Screw cap

⚠ CAUTION

Throughout the entire reversing procedure, keep all the small parts (screws, caps, etc.) of the refrigerator away from children or infants for safety reasons.

Step-by-step instructions

STEP 1 Remove the doors

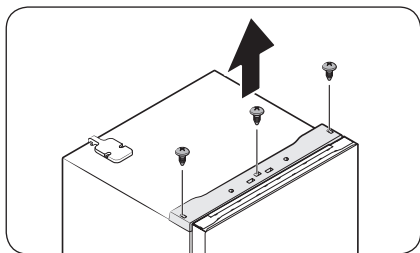

1. Use a Phillips screwdriver to loosen the screws (x3) in three holes on the **top table**. Then, gently pull out the **top table**.

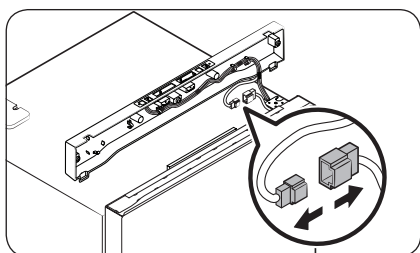

2. Decouple the **wire connectors**.

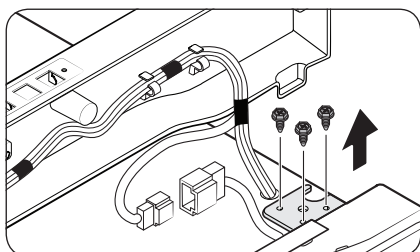

3. Loosen the bolts on the **top hinge**.

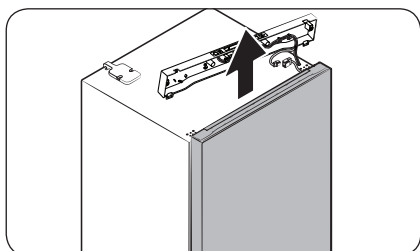

4. Gently lift up the **freezer door** to remove it.

Maintenance

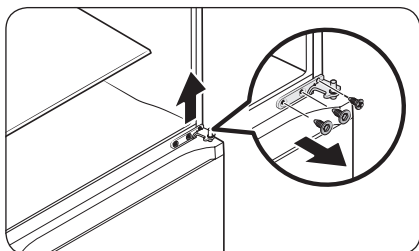

5. Use the screwdriver and the wrench to loosen the bolts and remove the **middle hinge**.

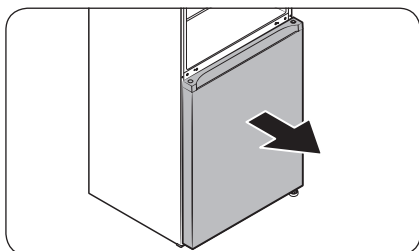

6. Gently slide the **fridge door** out of the **hinge shaft**, and then pull up to remove.

STEP 2 Remove the hinge and the door shaft

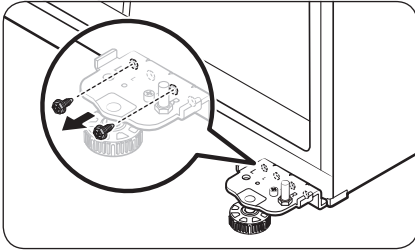

1. Use the screwdriver to remove the screw on the **bottom hinge**.

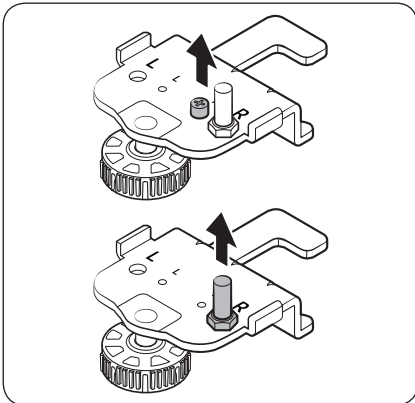

2. Use the screwdriver to remove the **hinge bolt**. Then, use the wrench to remove the **door shaft**.

Maintenance

STEP 3 Reverse the auto closer (freezer door only)

Now stand the refrigerator back upright with care, and then do the following.

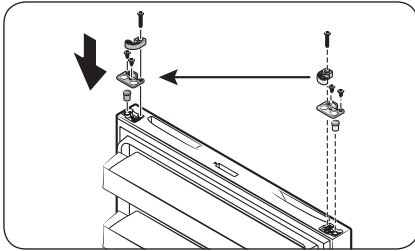

1. Remove the **auto closer** and the **stopper** from the bottom of the fridge door. Then, reinsert them on the opposite side of the fridge door as shown.

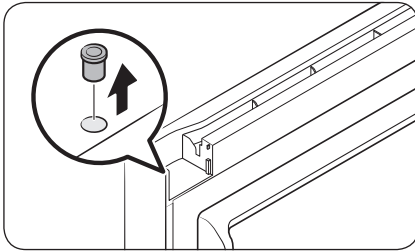

2. Use a flat-head screwdriver to remove the **hinge grommet**.

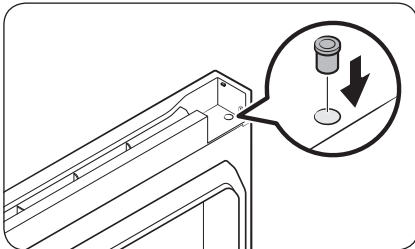

3. Reinsert the **hinge grommet** on the opposite side.

STEP 4 Reverse the bar cover and the top hinge

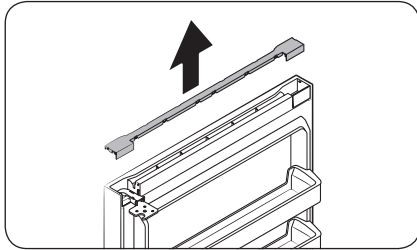

1. Pull up to remove the **bar cover** on the top of the freezer door.

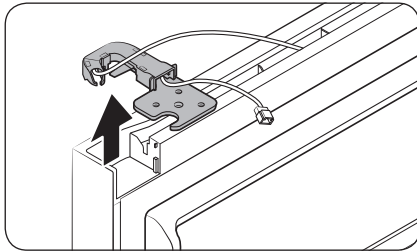

2. Remove the **top hinge** with its cover.

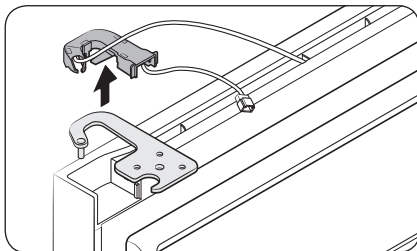

3. Separate the **top hinge** from the hinge cover.

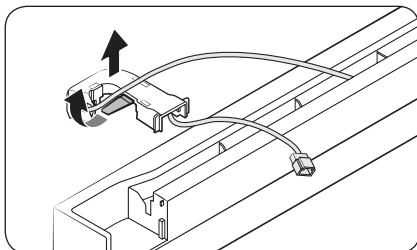

4. Arrange the door wire in the hinge cover.

Maintenance

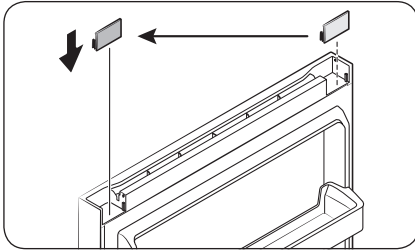

5. Remove the **cap spacer**, and then reinsert it on the opposite side.

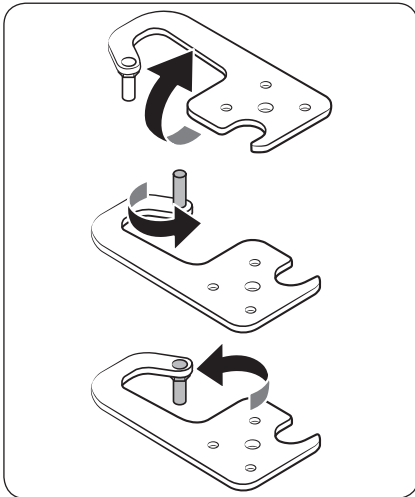

6. Remove the **door shaft** from the **top hinge**, flip it 180 degrees as shown, and then reinsert it .

STEP 5 Reattach the doors on the opposite side

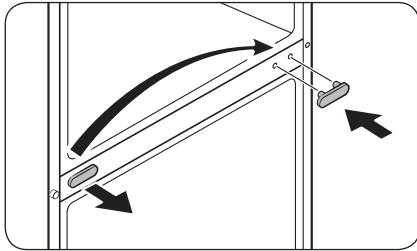

1. Use a flat-heat screwdriver to remove the **middle-hinge screw cap**, and then reinsert it on the opposite side.

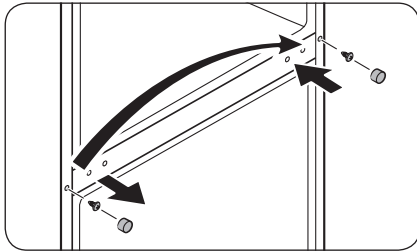

2. Use the flat-heat screwdriver to remove the **flange-screw cap** to reveal the **flange screw**. Use a Phillips screwdriver to remove the **flange screw**, and then tighten it on the opposite side. Finally, close the **flange-screw cap** on the opposite side.

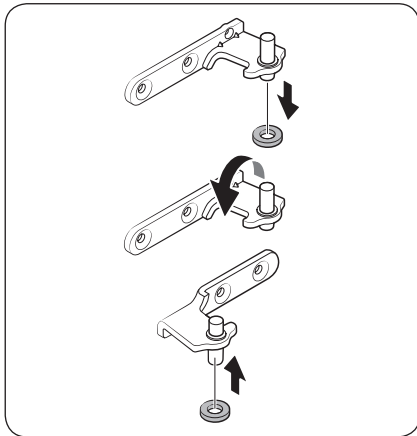

3. Remove the **grommet ring** from the **middle-hinge shaft**, and then reinsert the ring on the other side of the shaft. See the figure for visual reference.

Maintenance

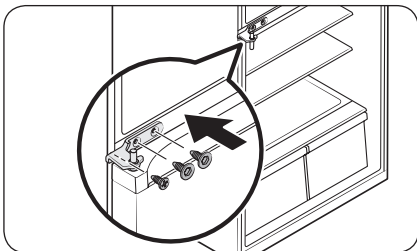

4. Reverse the **middle hinge** and insert it on the opposite side. Then, tighten the hinge with the screws.

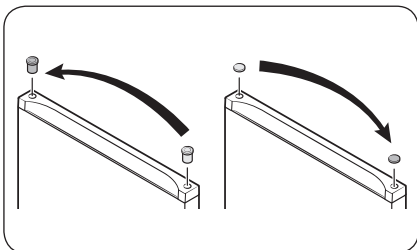

5. Use the flat-head screwdriver to remove both the **hinge grommet** on one side and the **hinge-hole cap** on the other side. Reinsert them on their respective opposite side.

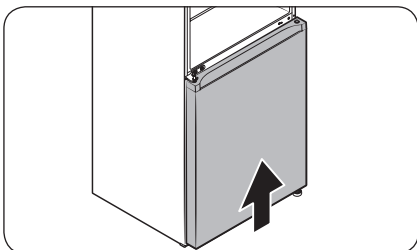

6. Gently slide the **fridge door** into the correction position so that it fits.

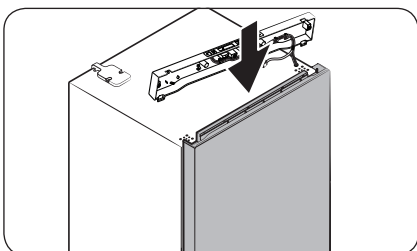

7. Gently slide the **freezer door** into the correction position so that it fits.

STEP 6 Reverse the bottom hinge

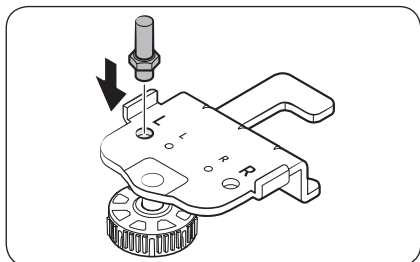

1. Insert the **door shaft** into the bottom hinge plate from the top as shown, and then tighten it until it is securely in place.

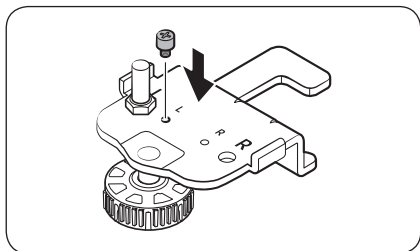

2. Insert the **hinge bolt** into the bottom hinge plate from the top as shown, and then tighten it until it is securely in place.

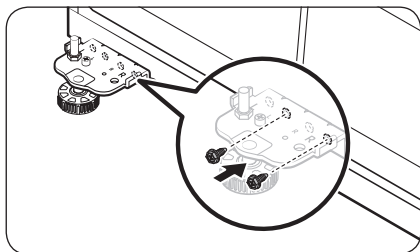

3. Position the bottom hinge plate on the opposite side, and then use two screws to secure and attach the hinge plate as shown.

Maintenance

STEP 7 Reattach the remaining parts

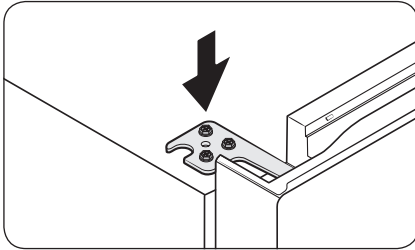

1. Insert and tighten the **top hinge** on the opposite side.

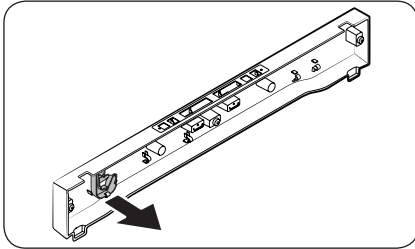

2. Detach the **hinge cover** manually from the **top table**.

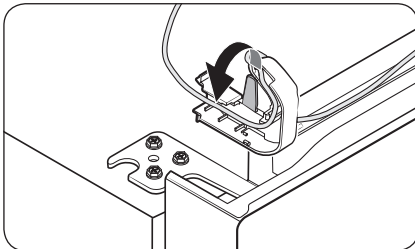

3. Arrange the **door wire** in the **hinge cover** before placing the **hinge cover** onto the **top hinge**.

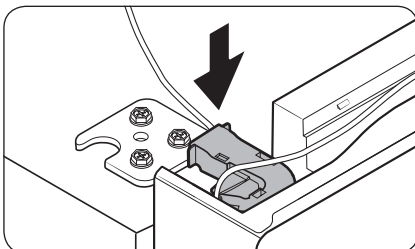

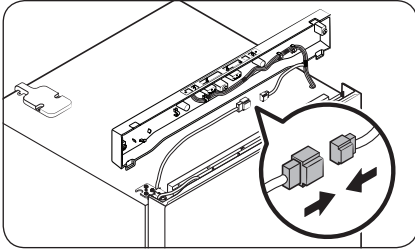

4. Connect the wire connectors.

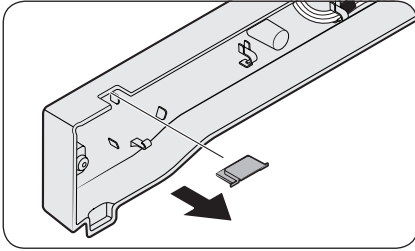

5. Remove the **hinge hole cap** from the **top table**, and then reinsert it on the opposite side.

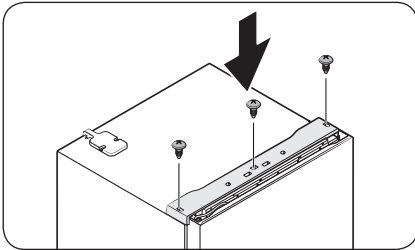
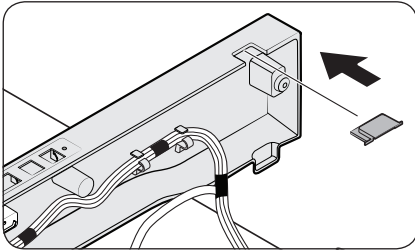

6. Insert the **top table**, and then fix it firmly to the refrigerator using the screws (x3).

Maintenance

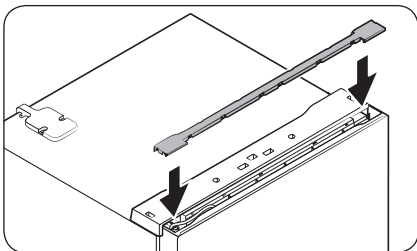

7. Insert the bar cover.

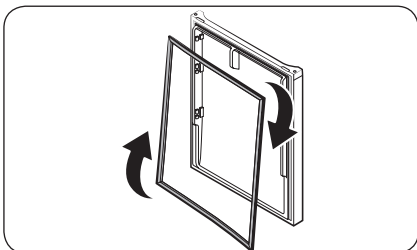

8. Remove the fridge door and freezer door gaskets. Turn them clockwise by 180 degrees, and then reattach them.

NOTE

In the future, you might want to return the doors to their initial position (before the doors were reversed). In that case, refer to the instructions on the previous pages, but switch the doors, hinges, and covers back to their initial positions.

Handle and care

Shelves / Multi tray (applicable models only)

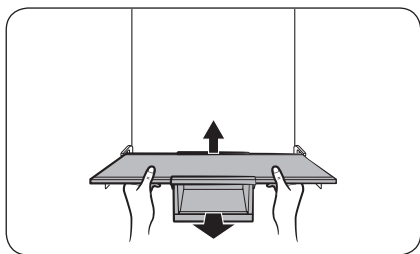

1. While lifting the rear side of the shelf, pull it slightly forward.

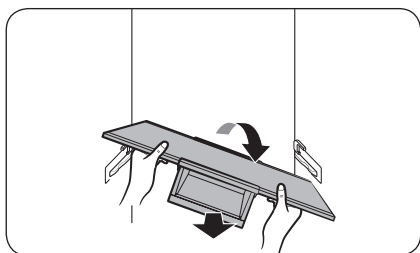

2. Tilt the shelf on one side and pull it out.

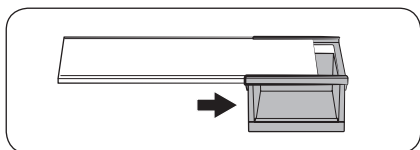

3. Push the multi tray sideways to separate it from the shelf.

Maintenance

Foldable shelf (applicable models only)

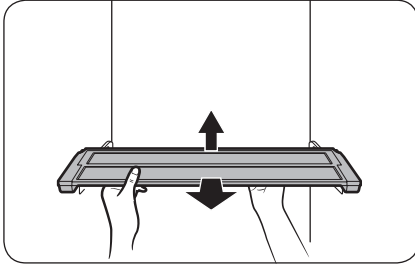

1. While lifting the rear side of the shelf, pull it slightly forward.

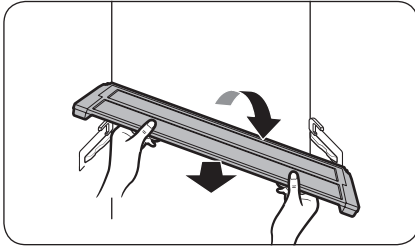

2. Tilt the shelf on one side and pull it out.

Door bin

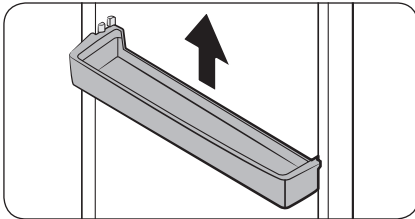

Slightly lift up and pull out the door bin.

⚠ CAUTION

To prevent accidents, empty the door bins before removing.

Drawers (Fridge/Freezer)

NOTE

Remove the bottom door bin in prior.

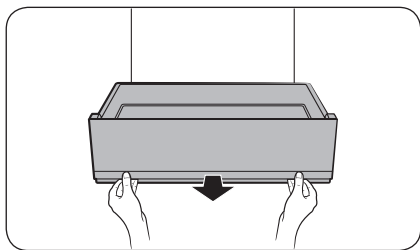

1. Pull the vegetable drawer slightly forward.

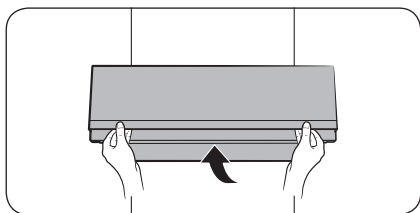

2. Slightly lift the vegetable drawer, and then pull it out.

Maintenance

Vegetable shelf

NOTE

Remove the bottom door bin in prior.

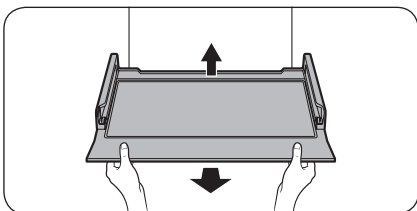

1. While lifting the rear side of the shelf, pull it slightly forward.

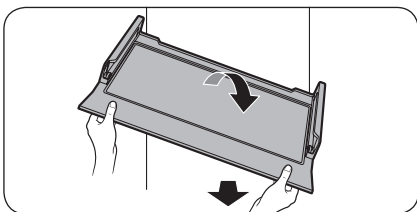

2. Tilt the shelf on one side and pull it out.

Disassembling Vegetable drawers/Freezer drawers

You can disassemble the drawer for a thorough cleaning.

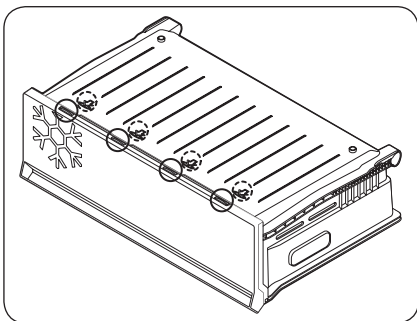

1. Remove the drawer from the refrigerator.
2. Flip the drawer upside down and place it on the floor. Check the four catches on the bottom.

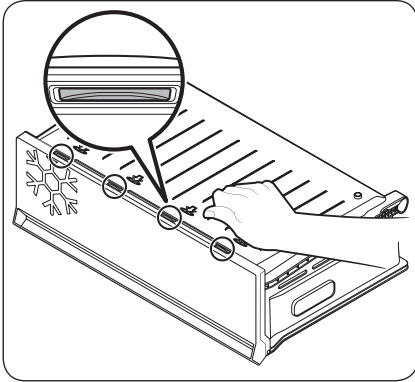

3. Press the arrow-marked section at the bottom of the drawer with your palm to disengage the catches.
 - Press each of the four catches one by one to disengage them.

⚠ CAUTION

Applying excessive force to the drawer may result in breakage and cause a risk of injury.

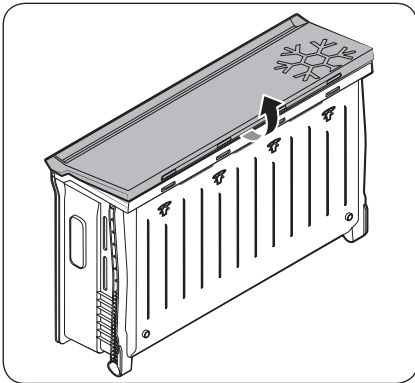

4. Pull the front of the drawer to separate it from the rest of the drawer.

Maintenance

Assemble Vegetable drawers/Freezer drawers

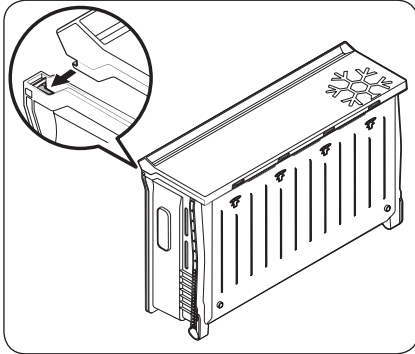

1. Place the drawer on the floor with the front of the drawer facing up. Align the hooks on the front part of the drawer, both on the left and right sides, with the grooves, and then snap them into place.

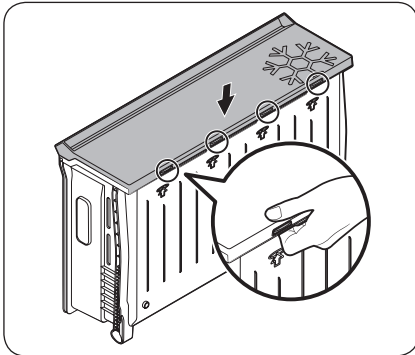

2. Press the front part of the cover, ensuring that the four catches (marked with circles in the figure) are properly engaged.

Cleaning

Interior and exterior

⚠ WARNING

- Do not use benzene, thinner, or home/car detergent such as Clorox™ for cleaning purposes. They may damage the surface of the refrigerator and cause a fire.
- Do not spray water onto the refrigerator. This may cause electric shock.

Regularly use a dry cloth to remove all foreign substances such as dust or water from the power plug terminals and contact points.

1. Unplug the power cord.
2. Use a moistened, soft, lint-free cloth or paper towel to clean the refrigerator's interior and exterior.
3. When done, use a dry cloth or paper towel to dry well.
4. Plug in the power cord.

Real panel / Compressor cover (applicable models only)

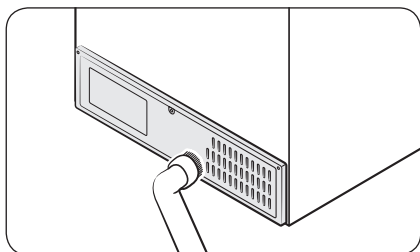

To keep cords and exposed parts of the rear panel free of dirt, vacuum the panel once or twice a year.

⚠ CAUTION

Do not remove the rear panel cover. Electric shock may occur.

Maintenance

Replacement

LED Lamps

To replace the lamps of the refrigerator, contact a local Samsung service centre.

WARNING

- The lamps are not user-serviceable. Do not attempt to replace a lamp yourself. This can cause electric shock.

Lamp (Light Source)

This product contains a light source of energy efficiency class <G>.

The lamp(s) and/or control gear(s) are not user-serviceable. To replace the lamp(s) and/or control gear(s) in the product, contact a local Samsung service centre.

For detailed instructions on replacing lamp(s) or control gear(s) in your product, visit the Samsung website (<http://www.samsung.com>), go to Support > Support home, and then enter the model name.

For detailed instructions on dismantling lamp(s) and/or control gear(s), simply follow the replacement instruction reached as described above.

Door panel (applicable models only)

You can select the door panel you prefer for your BESPOKE refrigerator. Purchase the door panel at a Samsung retail store and an authorized installer will install the panel for you.

CAUTION

- Disassembling or assembling the door panel on your own may result in product damage or personal injury. If you find any problems with the door panel, contact a Samsung service center
- A service fee may be charged for panel replacement even within the warranty period.

Troubleshooting

Before calling for service, review the checkpoints below. Any service calls regarding normal situations (No Defect Cases) will be charged to users.

General

Temperature

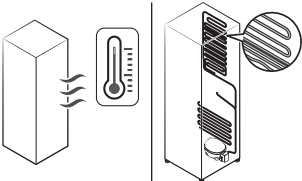
Symptom	Possible causes	Solution
Fridge/freezer does not operate. Fridge/freezer temperature is warm.	<ul style="list-style-type: none"> Power cord is not plugged in properly. 	<ul style="list-style-type: none"> Properly plug in the power cord.
	<ul style="list-style-type: none"> Temperature control is not set correctly. 	<ul style="list-style-type: none"> Set the temperature lower.
	<ul style="list-style-type: none"> Refrigerator is located near a heat source or direct sunlight. 	<ul style="list-style-type: none"> Keep the refrigerator away from direct sunlight or a heat source.
	<ul style="list-style-type: none"> Not enough clearance between refrigerator and sides/rear. 	<ul style="list-style-type: none"> Make sure there are at least 5 cm from the rear and sides.
	<ul style="list-style-type: none"> The Vacation function is activated. 	<ul style="list-style-type: none"> Deactivate the Vacation function.
	<ul style="list-style-type: none"> The refrigerator is overloaded. Food is blocking the refrigerator vents. 	<ul style="list-style-type: none"> Do not overload the refrigerator. Do not allow food to block ventilation.
Fridge/freezer is over-cooling.	<ul style="list-style-type: none"> Temperature control is not set correctly. 	<ul style="list-style-type: none"> Set the temperature higher.
Interior wall is hot.	<ul style="list-style-type: none"> Refrigerator has heat-proof piping in the interior wall. 	<ul style="list-style-type: none"> To prevent condensation from forming, the refrigerator has heat-proof piping in the front corners. If the ambient temperature rises, this equipment may not work effectively. This is not a system failure. 

Troubleshooting

Odours

Symptom	Possible causes	Solution
Refrigerator has odours.	<ul style="list-style-type: none"> Spoiled food. 	<ul style="list-style-type: none"> Clean the refrigerator and remove any spoiled food.
	<ul style="list-style-type: none"> Food with strong odours. 	<ul style="list-style-type: none"> Make sure strong smelling food is wrapped airtight.

Frost

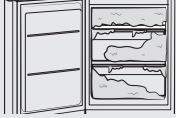
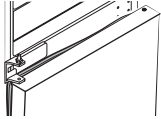
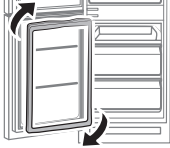
Symptom	Possible causes	Solution
Frost around the vents.	<ul style="list-style-type: none"> Food is blocking the vents. 	<ul style="list-style-type: none"> Make sure no food blocks the refrigerator vents.
Frost on interior walls.	<ul style="list-style-type: none"> Door is not closed properly. 	<ul style="list-style-type: none"> Make sure food does not block the door. Clean the door gasket.
Excessive frost build-ups in the freezer. 	<ul style="list-style-type: none"> The door is not sealing properly because the door gasket was not reversed after reversing the doors.  	<ul style="list-style-type: none"> Detach the door gasket and then attach it after rotating it 180°. 

Condensation

Symptom	Possible causes	Solution
Condensation forms on the interior walls.	<ul style="list-style-type: none"> If door is left open, moisture enters the refrigerator. 	<ul style="list-style-type: none"> Remove the moisture and do not open the door for a long time.
	<ul style="list-style-type: none"> Food with high moisture content. 	<ul style="list-style-type: none"> Make sure food is wrapped airtight.

Do you hear abnormal sounds from the refrigerator?

Before calling for service, review the checkpoints below. Any service calls related to normal sounds will be charged to the user.

These sounds are normal.

- When starting or ending an operation, the refrigerator may make sounds similar to a car engine igniting. As the operation stabilizes, the sounds will decrease.

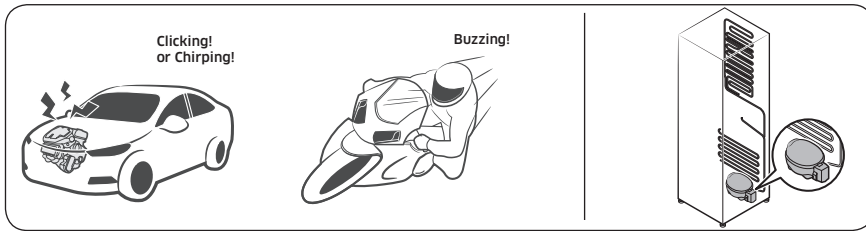

- While the fan is operating, these sounds may occur. When the refrigerator reaches the set temperature, no fan sound will occur.

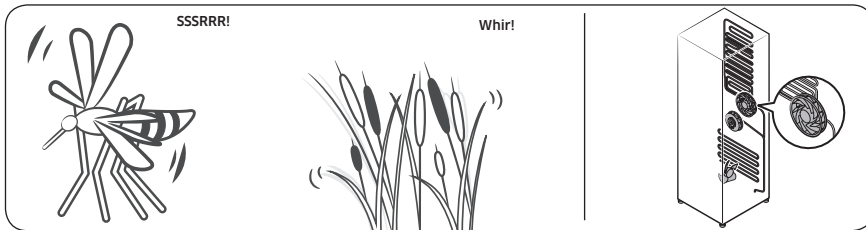

- During a defrost cycle, water may drip on the defrost heater, causing sizzling sounds.

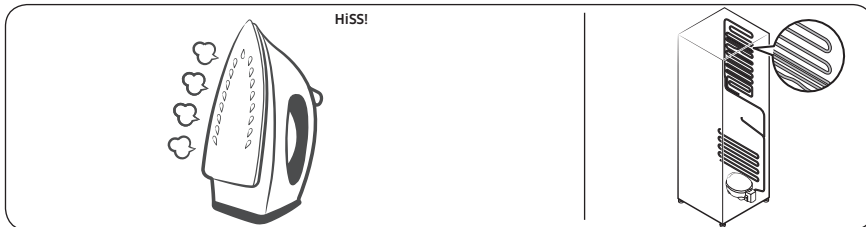

Troubleshooting

- As the refrigerator cools or freezes, refrigerant gas moves through sealed pipes, causing bubbling sounds.

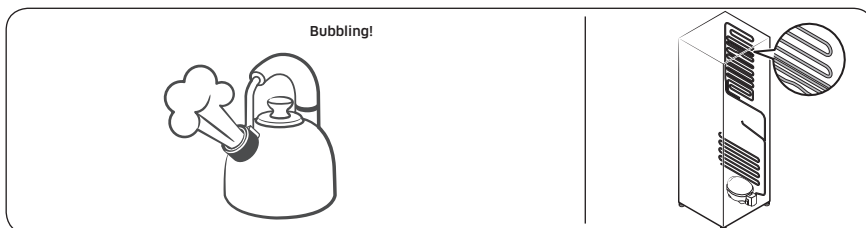

- As the refrigerator temperature increases or decreases, plastic parts contract and expand, creating knocking noises. These noises occur during the defrosting cycle or when electronic parts are working.

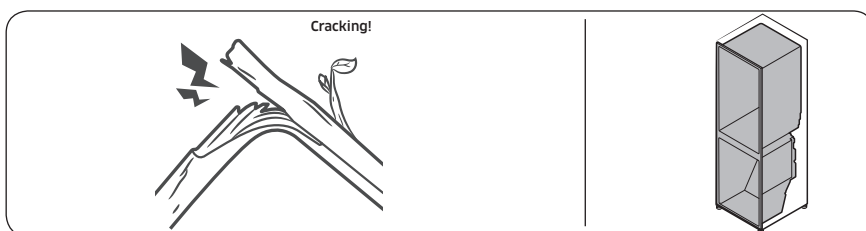

- For ice maker models: When the water valve opens to fill the ice maker, buzzing sounds may occur.
- Because of pressure equalizing when opening and closing the refrigerator door, whooshing sounds may occur.

SmartThings (applicable models only)

Symptom	Action
Could not find "SmartThings" in the app market.	<ul style="list-style-type: none"> The supporting software version of the SmartThings app is subject to change according to the OS supporting policy the manufacturer provides. In addition, as for the SmartThings app or the functions that the app supports, the new application update policy on the existing OS version can be suspended due to usability or security reasons.
The SmartThings app fails to operate.	<ul style="list-style-type: none"> The SmartThings app is available for applicable models only. The old Samsung Smart Refrigerator app cannot connect with Samsung Smart Home models.
The SmartThings app is installed but is not connected to my refrigerator.	<ul style="list-style-type: none"> You must log into your Samsung account to use the app. Make sure that your router is operating normally. If the Wi-Fi icon on the refrigerator's display is off, this indicates that no network connection has been established yet. In this case, use the SmartThings app to connect and register your refrigerator to the access point (AP) of your house.
Could not log into the app.	<ul style="list-style-type: none"> You must log into your Samsung account to use the app. If you don't have a Samsung account, follow the app's onscreen instructions to create one.
An error message appears when I try to register my refrigerator.	<ul style="list-style-type: none"> Easy Connection may fail due to the distance from your access point (AP) or electrical interference from the surrounding environment. Wait a moment and try again.
The SmartThings app is successfully connected to my refrigerator but does not run.	<ul style="list-style-type: none"> Exit and restart the SmartThings app, or disconnect and reconnect the router. Power off the refrigerator, and then power it on again after 1 minute.
The Wi-Fi icon is blinking. ()	<ul style="list-style-type: none"> Connect your refrigerator with the SmartThings app before use. When the connection is made successfully, the indicator stops blinking. <ul style="list-style-type: none"> If you fail to make connection or don't want to use the app, press and hold the > button for 10 seconds. The indicator stops blinking with "OFF" shown on the temperature display.

Appendix

Safety Instruction

- For the most efficient use of energy, please keep the all inner fittings such as baskets, drawers, shelves and ice cube tray on the position supplied by manufacturer.
- This refrigerating appliance is not intended to be used as a built-in appliance.

Install Instruction

For refrigerating appliances with climate class

Depending on the climate class, This refrigerating appliance is intended to be used at ambient temperatures range as specified following table.

The climate class can be found on the rating plate. The product may not operate properly at temperatures outside of the specific range.

You can find climate class on label inside of your refrigerator

Effective temperature range

The refrigerator is designed to operate normally in the temperature range specified by its class rating.

Class	Symbol	Ambient Temperature range (°C)	
		IEC 62552 (ISO 15502)	ISO 8561
Extended Temperate	SN	+10 to +32	+10 to +32
Temperate	N	+16 to +32	+16 to +32
Subtropical	ST	+16 to +38	+18 to +38
Tropical	T	+16 to +43	+18 to +43

NOTE

The cooling performance and power consumption of the refrigerator may be affected by the ambient temperature, the door-opening frequency, and the location of the refrigerator. We recommend adjusting the temperature settings as appropriate.

Temperature Instruction

Recommended Temperature

The optimal temperature setting for food storage:

- Fridge: 3 °C
- Freezer: -19 °C

NOTE

The optimal temperature setting of each compartment depends on the ambient temperature. Above optimal temperature is based on the ambient temperature of 25 °C.

Power Cool

Power Cool speeds up the cooling process at maximum fan speed. The fridge keeps running at full speed for two and a half hours and then returns to the previous temperature.

Power Freeze

Power Freeze speeds up the freezing process at maximum fan speed. The freezer keeps running at full speed for 50 hours and then returns to the previous temperature. To freeze large amounts of food, activate Power Freeze for at least 20 hours before putting food in the freezer.

NOTE

When you use this function the energy consumption of the refrigerator will increase. Remember to turn it off when you don't need it and return the freezer to your original temperature setting.

How to store for best preservation (applicable models only)

Cover foods to retain moisture and prevent them from picking up odors from other foods. A large pot of food like soup or stew should be divided into small portions and put in shallow containers before being refrigerated. A large cut of meat or whole poultry should be divided into smaller pieces or placed in shallow containers before refrigerating.

Placement of Foods

Shelves	Shelves should be adjustable to accommodate a variety of packages.
Specialized compartment (applicable models only)	Sealed crisper drawers provide an optimal storage environment for fruits and vegetables. Vegetables require higher humidity conditions while fruits require lower humidity conditions. Crispers are equipped with controls devices to control the humidity level. (*Depending on model and options) An adjustable temperature meat drawer maximizes the storage time of meats and cheeses.

Appendix

Stored on the door	Don't store perishable foods in the door. Eggs should be stored in the carton on a shelf. The temperature of the storage bins in the door fluctuate more than the temperature in the cabinet. Keep the door closed as much as possible.
Freezer Compartment	You can store frozen food, make ice cubes and freeze fresh food in the freezer compartment.

NOTE

Freeze fresh, undamaged food only. Keep food which is to be frozen away from food which is already frozen. To prevent food from losing its flavour or drying out, place in airtight containers.

Refrigerator & Freezer Storage Chart

The freshness longevity depends on temperature and exposure to moisture. Since product dates aren't a guide for safe use of a product, consult this chart and follow these tips.

Milk products

Product	Refrigerator	Freezer
Milk	1 week	1 month
Butter	2 weeks	12 months
Ice cream	-	2-3 weeks
Natural cheese	1 month	4-6 months
Cream cheese	2 weeks	Not recommended
Yogurt	1 month	-

Meat

Product	Refrigerator	Freezer
Fresh roasts, steaks, chops	3-4 days	2-3 months
Fresh ground meat, stew meat	1-2 days	3-4 months
Bacon	7 days	1 month
Sausage, Raw from pork, beef, turkey	1-2 days	1-2 months

Poultry / Eggs

Product	Refrigerator	Freezer
Fresh poultry	2 days	6-8 months
Poultry salad	1 day	-
Eggs, Fresh in shell	2-4 weeks	Not recommended

Fish / Seafood

Product	Refrigerator	Freezer
Fresh fish	1-2 days	3-6 months
Cooked fish	3-4 days	1 month
Fish salad	1 day	Not recommended
Dried or pickled fish	3-4 weeks	-

Fruits

Product	Refrigerator	Freezer
Apples	1 month	-
Peaches	2-3 weeks	-
Pineapple	1 week	-
Other fresh fruit	3-5 days	9-12 months

Vegetables

Product	Refrigerator	Freezer
Asparagus	2-3 days	-
Broccoli, Brussels sprouts, green peas, mushrooms	3-5 days	-
Cabbage, cauliflower, celery, cucumbers, lettuce	1 week	-
Carrots, beets, radishes	2 weeks	-

Appendix

Information for model and ordering spare parts

Model information

To access energy labelling information about this product on the European Product Registry for Energy Labelling (EPREL), scan QR-Code on the energy label. You can find QR-Code on the energy label in your product box.

Part information

- The minimum period during which spare parts, necessary for the repair of the appliance, are available
 - 7 Years thermostats, temperature sensors, printed circuit boards and light sources, door handles, door hinges, trays, baskets (boxes or drawers)
 - 10 Years door gaskets
- The minimum duration of the guarantee of the refrigerating appliance offered by the manufacturer 24 Months.
- Relevant information for ordering spare parts, directly or through other channels provided by the manufacturer, importer or authorized representative
- You can find professional repair information on <http://samsung.com/support>. You can find user servicing manual on <http://samsung.com/support>.

Open Source Announcement

The software included in this product contains open source software. You may obtain the complete corresponding source code for a period of three years after the last shipment of this product by contacting our support team via <http://opensource.samsung.com> (Please use the "Inquiry" menu.)

It is also possible to obtain the complete corresponding source code in a physical medium such as a CD-ROM; a minimal charge will be required.

The following URL http://opensource.samsung.com/opensource/Common_TZ6_0/seq/0 leads to the open source license information as related to this product. This offer is valid to anyone in receipt of this information.



Memo

Memo

NOTE

Hereby, Samsung declares that this radio equipment is in compliance with Directive 2014/53/EU and with the relevant statutory requirements in the UK.

The full text of the EU declaration of conformity and the UK declaration of conformity is available at the following internet address: The official Declaration of conformity may be found at <http://www.samsung.com>, go to Support > Search Product Support and enter the model name.

	Frequency range	Transmitter power (Max)
Wi-Fi	2412 - 2472 MHz	20 dBm
Bluetooth	2402 - 2480 MHz	20 dBm

Contact SAMSUNG WORLD WIDE

If you have any questions or comments relating to Samsung products, please contact the SAMSUNG customer care centre.

Country	Contact Center	Website
UK	0333 000 0333	www.samsung.com/uk/support
IRELAND (EIRE)	0818 717100	www.samsung.com/ie/support

