

名称	订单说明书
首次使用型号	1B0528Z0258J
材料	70g双胶纸
页面规格/颜色	A5大小黑白印刷
技术要求	<ol style="list-style-type: none"> 1. 印刷颜色应均匀，且无毛边，无脏点、划伤、折痕，在使用环境下不褪色，不变色，不起翘。 2. 图案和文字清晰完整，无错印、漏印、重影。 3. 装订牢固，裁切整齐。 4. 制品应符合Q/HKB J 16001《零、部件及原材料中有害化学物质含量规定》要求。 5. 未注尺寸公差按企标 Q/HKB J01002 附录D中的 中等 m 执行。 6. 首样经技术人员确认方可批量生产。
备注	<ol style="list-style-type: none"> 1. 前3页WARNING字高不小于3.5mm 2. 防火标签高度至少为15mm高
升版原因	



设计	孙婷	审核	陈思萌	日期	2025-12-03
批准	白莉	版本号	A	图号/物料号	N6020012175/20176971

USER'S OPERATION MANUAL



Before operating this unit, please read this manual thoroughly, and retain for future reference. This is a short version of the User's Manual. For more information, please scan the QR code above to view the full version of the manual.

NOTE:

1. Please adjust your mobile or tablet device to portrait mode during the browsing of electronic manuals to achieve the best viewing experience. 2. To ensure a smooth experience with the download feature of the electronic manuals, we recommend using Google Chrome, Microsoft Edge, or the Safari browser.

EN

English

SAFETY AND WARNING INFORMATION

Before using the appliance for the first time

Before connecting the appliance to the power mains, please read carefully the instructions for use which describe the appliance and its correct and safe use. The instructions apply to several appliance types/models; thus, settings or equipment may be described herein which is not available in your appliance. We recommend saving this instruction manual for future reference and attach it to the appliance if it is sold in the future.

Check for any damage or irregularities on your appliance. If you find your appliance is damaged, notify the retailer from which you have purchased the appliance.

Before connecting the appliance to the power mains, let the appliance rest in a vertical position for a minimum of 2 hours. This will reduce the possibility of operation faults due to the effect of transport on the cooling system.

Important safety instructions



WARNING Risk of fire/flammable materials

The appliance must be connected to the power mains and grounded in compliance with the effective standards and regulations.

⚠ WARNING

Do not locate multiple portable socket-outlets or portable power supplies at the rear of the appliance.

Before cleaning the appliance, unplug it from the power mains (unplug the power cord from the wall outlet).

⚠ WARNING

If the supply cord is damaged, it must be replaced by the manufacturer, its service agent or similarly qualified persons in order to avoid a hazard.

⚠ WARNING

When positioning the appliance, ensure the supply cord is not trapped or damaged.

⚠ WARNING

⚠ WARNING

Do not use electrical appliances inside the food storage compartments of the appliance, unless they are of the type recommended by the manufacturer.

⚠ WARNING

Do not use mechanical devices or other means to accelerate the defrosting process, other than those recommended by the manufacturer.

⚠ WARNING

To avoid any hazard resulting from poor stability of the appliance, make sure it is installed as instructed.

Freeze burn hazard

To avoid freeze burn, never put frozen food in your mouth and do not touch frozen food.

Safety of children and vulnerable persons

The appliance is not intended for use by persons (including children) with reduced physical, sensory or mental capabilities, or lack of experience and knowledge, unless they have been given supervision or instruction concerning use of the appliance by a person responsible for their safety.

Children should be supervised to ensure that they do not play with the appliance.

Cleaning and user maintenance shall not be made by children without supervision.

Remove the packaging intended to protect the appliance or particular parts during transport and keep it outside the reach of children. It presents danger of injury or suffocation.

When removing a used appliance, disconnect the power cord, remove the door, and leave the shelves in the appliance. This will prevent children from locking themselves in the appliance.

For European markets only

This appliance can be used by children aged from 8 years and above and persons with reduced physical, sensory or mental capabilities or lack of experience and knowledge if they have been given supervision or instruction concerning use of the appliance in a safe way and understand the hazards involved.

Children shall not play with the appliance.

Cleaning and user maintenance shall not be made by children without supervision.

Children aged from 3 to 8 years are allowed to load and unload refrigerating appliances.

Warning regarding the refrigerant

The appliance contains a small amount of an environmentally friendly yet flammable gas R600a. Make sure that no parts of the cooling system are damaged. A gas leak is not hazardous to the environment, but it could cause eye injury or fire.

In case of a gas leak, ventilate the room thoroughly, disconnect the appliance from the power mains, and call a service technician.

Important information on the use of appliance

⚠ WARNING

This appliance is intended to be used in residential household and similar applications such as:

- staff kitchen areas in shops, offices and other working environments;
- farm houses and by clients in hotels, motels and other residential type environments;

- bed and breakfast type environments;
- catering and similar non-retail applications.

⚠ WARNING

Keep ventilation openings, in the appliance enclosure or in the built-in structure, clear of obstruction.

The appliance may not be used outdoors and it may not be exposed to rain.

Do not store explosive substances such as aerosol cans with a flammable propellant in this appliance.

If the appliance will be out of use for an extended period of time, switch it off using the relevant button, and unplug it from the power mains. Empty the appliance, defrost it, clean it, and leave the door ajar.

In case of an error or power supply failure, do not open the freezer compartment unless the freezer has not operated for over 16 hours. After this period, use the frozen food or provide sufficient cooling (e.g. a replacement appliance).

Technical information on the appliance

Rating plate can be found in the appliance interior. It indicates data on voltage, gross and net volume, type and amount of refrigerant, and information on the climate classes.

If the language on the rating plate is not the language of your choice or the language of your country, replace it with the one supplied.

⚠ WARNING

Do not damage the refrigerant circuit.

Hose-sets supplied using (special for ice maker products):

When the new hose-sets supplied with the appliance are used and the old hose-sets should not be reused.

INSTALLING YOUR NEW APPLIANCE

- Stand your appliance in a dry and well ventilated place. Keep the appliance out of direct sunlight, rain or frost.
- The diagram shows the temperature range of each climate class. The climate class of this appliance is specified on the rating plate. Use beyond this range may result in poor performance.

Climate class	Ambient temperature
SN	+10°C to +32°C
N	+16°C to +32°C
ST	+16°C to +38°C
T	+16°C to +43°C

- Sufficient clear space should be available around the appliance to facilitate ventilation and heat dissipation.
- Suggested space is indicated in the figure.

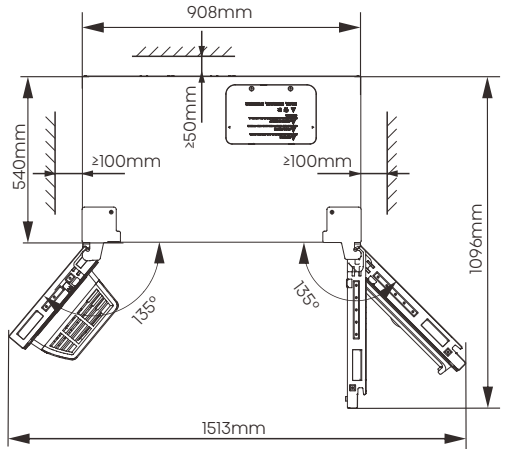
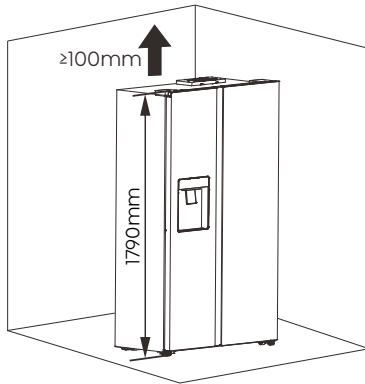

Leveling of appliance (if needed):

- The figure is for reference only.
- The appliance is fitted with adjustable feet that can be used to level the appliance.
- To allow the doors to self-close, tilt the top backwards by turning the adjustable feet.

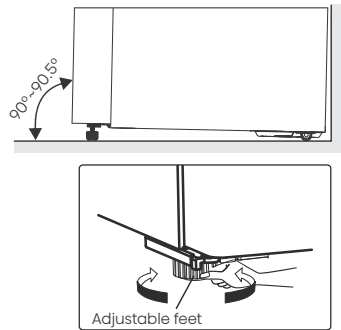

WARNING

- For proper installation, this appliance must be placed on a level surface of hard material that is the same height as the rest of the flooring. This surface should be strong enough to support a fully loaded appliance.
- The rollers should be only used for forward or backward movement. Moving the appliance sideways may damage your floor and the rollers.

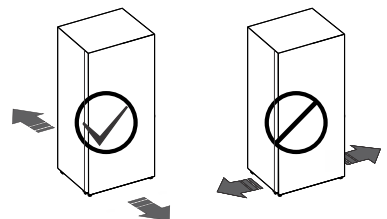

DESCRIPTION OF THE APPLIANCE

- Appliance interior equipment may change according to the appliance model.
- The diagram may slightly differ from the appliance you purchased, please get more information in the E-manual.

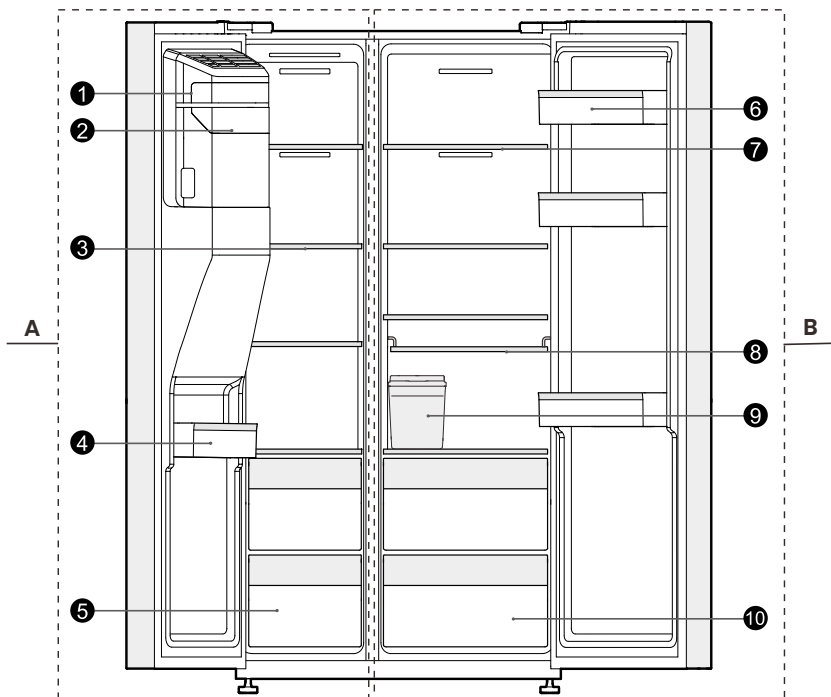

A: Freezer

1. Ice-maker cover
2. Ice bucket
3. Shelf
4. Door rack
5. Drawer

B: Fridge

6. Door rack
7. Shelf
8. Bottle rack *
9. Water tank *
10. Drawer

* : Only in some models.

CONTROL PANEL

NOTE: The control panel may differ by model, so choose according to your appliance. Please refer to the E-manual for more information.

TYPE 1:

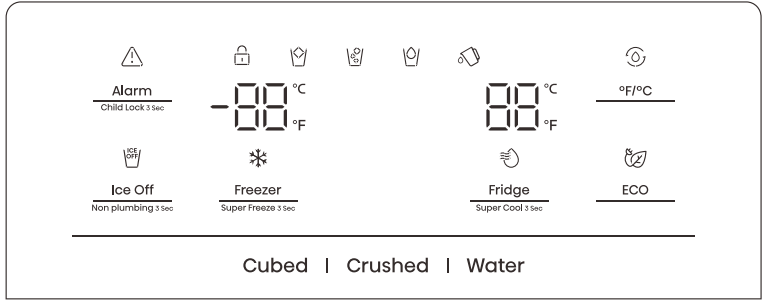

TYPE 2:

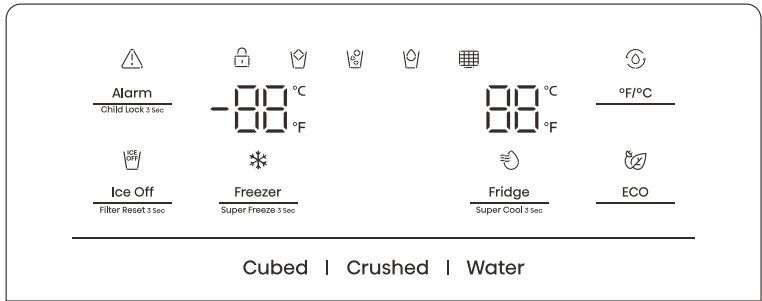

Child Lock

Press and hold the "Alarm" button for 3 seconds to lock all controls, the "  " will be on. To unlock, press and hold the "Alarm" button for 3 seconds again.

Door Alarm

Any door open for more than 1 minutes will activate the door alarm, the "  " will be on. Press the "Alarm" button or close all doors to stop it.

Ice Off

Touch the "Ice Off" button to turn off the ice maker, and the icon "  " will be illuminated. Touch the "Ice Off" button again to turn on the ice maker.

NOTE: When the Ice Off is on, it only locks the ice maker not the dispenser.

°F/°C

When the Child Lock is off, press the "°F/°C" button to switch between Celsius and Fahrenheit(default) units, and the Fahrenheit indicated by the "  " icon.

Fridge Temperature Control

Press "Fridge" button continuously to set the fridge temperature from 46°F(8°C) to 36°F(2°C).

Freezer Temperature Control

Press "Freezer" button continuously to set the freezer temperature from 7°F(-14°C) to -11°F(-24°C).

Super Cool

Press and hold the "Fridge" button for 3 seconds to activate Super Cool "  ", the fridge temperature will display 36°F(2°C),

which auto-turns off after 6 hours or when "Fridge" button is pressed.

Super Freeze

Press and hold the "Freezer" button for 3 seconds to activate Super Freeze "❄️", the freezer temperature will display -11°F(-24°C), which auto-turns off after 52 hours or when "Freezer" button is pressed.

NOTE: Touch the "Eco" button will turn off Super Cool/ Super Freeze mode.

Eco

Press the "Eco" button to switch on Eco mode, the icon "🌿" lights, which sets fridge to 43°F(6°C) and freezer to 1°F(-17°C). Turning it off reverts to previous settings.

Dispenser Control

With Child Lock off, select "Cubed" - "🧊" or "Crushed" - "🧊" for ice type, or "Water" - "🍶" for water, each with a corresponding illuminated icon.

Tank reset or Water shortage reminder(TYPE 1 only)

If the water tank is not installed in place or short of water, the "💧" icon will flicker. To extinguish the "💧" icon, press the "Ice Off" button for 3 seconds.

Filter Reset(TYPE 2 only)

Generally, change the water filter every 6 months to ensure the highest possible water quality. When the filter icon "🧺" blinks, replace the water filter, then press and hold the "Ice Off" button for 3 seconds to reset the water filter state.

Demo Mode

This mode, indicated by "OF", stops making cool air but appears working. Cancel it by pressing "Alarm" + "°F/°C" for 3 seconds and the buzzer beeps 3 times.

USING THE APPLIANCE

Water tank(TYPE 1 only)

It is for providing water for ice maker and water dispenser. If you need to inpour water into the water tank, you can lift the front small cover, and then inpour directly. It can be removed horizontal outward if you need to clean it.

⚠️ WARNING

Fill with portable water only.

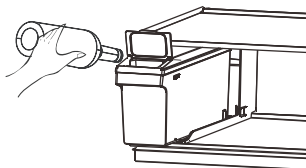

Installing the water filter(TYPE 2 only)

Fit the water filter

1. Take out the water filter and water lines from the fridge room.
2. Determine the location to mount the external filter.
3. Determine the distance between the filter and the tap, and the distance from the filter to the fridge. Prepare lines as required lengths.(Cut the proper lengths of water lines which you determine to connect with the filter inlet or outlet.)
4. Mount the filter holder onto the wall by using a screwdriver and attach the water filter.

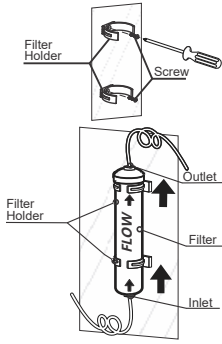

Installing the water lines of the filter

1. Take the 2 clips out, then pull out the 2 stopper of the water filter.

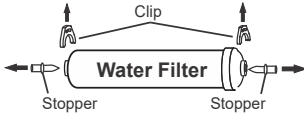

2. Fully insert the water lines into the Inlet and Outlet of the water filter.

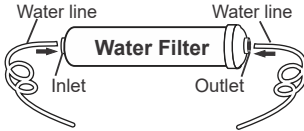

3. Insert the 2 clips in the proper position as the figure shown below, and confirm that each clip holds the water line firmly.

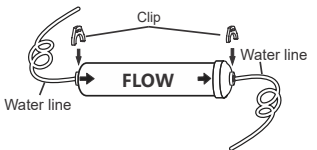

Connecting the filter inlet line to the water supplier

Screw the adaptor onto a suitable 3/4" BSP connector water outlet, and use the spanner to tighten it. Fully insert the water line into the check valve. Then insert the clip in the install pack as the figure shown below.

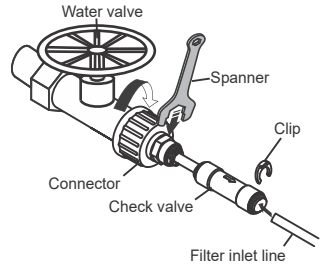

After installed the filter, please open the water valve to flush the filter for 5 minutes before use.

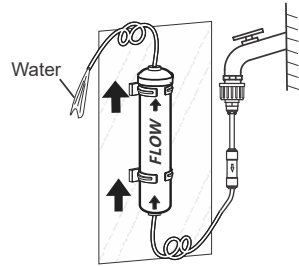

Connect filter outlet line to the fridge

Insert the 2 clips in the install pack as shown in the diagram, and then confirm that each clip holds the line firmly.

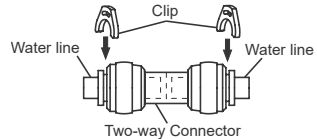

NOTE: After connect the filter outlet line with the refrigerator(as shown in the diagram below), please dispense lines before use.

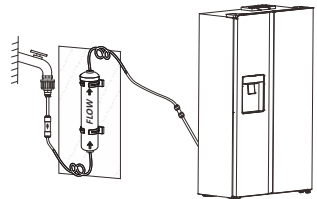

⚠ WARNING

After turning on the water valve, make sure that there is no leakage at all

connection points of the water lines.
If there is a leakage, turn off the valve immediately and tighten the water connector or make the lines fully inserted into the connector.

Getting cold water and ice

Press the appropriate ice or water type button to select what you want to dispense, and then press your glass against the dispenser lever(A) to get water/ice.

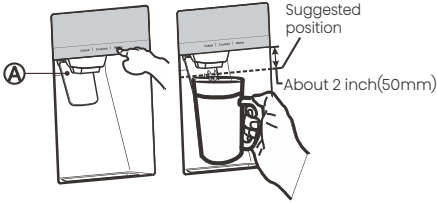

Using the ice bucket

Removing steps:

1. Lift up the Ice Bucket.
2. Pull the Ice Bucket out slowly.

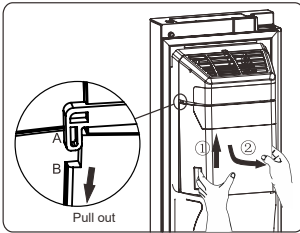

When you put it back, please make sure the two side(B&B') of Ice Bucket is wedged into the buckles(A&A').

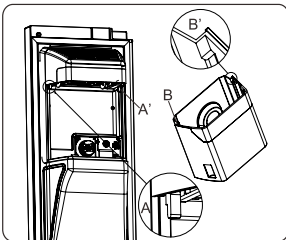

Installing steps:

1. Push the Ice Bucket up, and make the two side(B&B') of Ice Bucket wedge into the buckles(A&A').
2. Pull the Ice Bucket down, and make sure the Ice Bucket is held the bracket firmly.

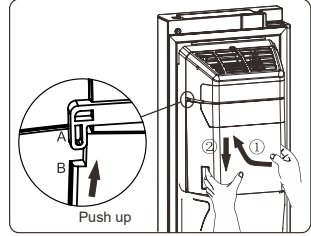

If ice doesn't come out, please check for any ice stuck in the chute and remove it. Or pull out the Ice Bucket and check for any ice cubes clump, then remove them.

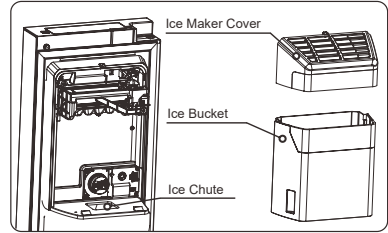

Do not allow your children to hang off the dispenser or pluck the ice storage bin. This could cause injury.

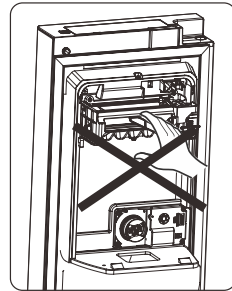

CLEANING AND CARE

- For hygiene, clean the appliance (exterior and interior accessories) regularly at least every two months.
- Ensure the appliance is completely dry before switching back on and plugging back into the mains socket.
- Wipe the inside of the appliance with a weak solution of bicarbonate of soda, and then rinse with warm water using a wrung-out sponge or cloth.
- Take care to keep door seals clean. Sticky food and drinks can cause seals to stick to the cabinet. Wash the seals with a mild detergent and warm water. Rinse and dry them thoroughly after cleaning.
- This product contains a light source of energy efficiency class G.
- For more cleaning details, please refer to the E-manual.



HELPFUL HINTS AND TIPS

Energy saving tips

We recommend that you follow the tips to save energy.

- Try to avoid keeping the door open for long periods.
- Ensure the appliance is away from any sources of heat.
- Don't set the temperature colder than necessary.
- Don't store warm food or evaporating liquid in the appliance.

Switching off your appliance

If the appliance needs to be switched off for an extended period, the following steps should be taken prevent mould on the appliance.

1. Remove all food.
2. Remove the power plug from the mains socket.
3. Clean and dry the interior thoroughly.
4. Ensure that all the doors are wedged open slightly to allow air to circulate.

- Please refer to the E-manual for more information.

TROUBLESHOOTING

- If you experience a problem with your appliance or are concerned that the appliance is not functioning correctly, you can carry out the following easy checks before calling for service.
- **NOTE:** You can find more relevant information in the E-manual.

⚠ WARNING

Don't try to repair the appliance yourself. If the problem persists after you have made the checks mentioned below, contact a qualified electrician, authorized service engineer or the shop where you purchased the product.

Problem	Possible cause & Solution
Appliance is not working correctly	Check whether the power cord is plugged into the power outlet properly.
	The ambient temperature is too low. Try setting the chamber temperature to a colder level to solve this problem.
A layer of frost occurs in the compartment	Check that the air outlets are not blocked by food and ensure food is placed within the appliance to allow sufficient ventilation. Ensure that the door can be fully closed.
Temperature inside is too warm	You may have left the doors open too long or too frequently; or the doors are kept open by some obstacle; or the appliance is located with insufficient clearance at the sides, back and top.
Unable to connect appliance to Wi-Fi network	The Wi-Fi password was entered incorrectly, or the network could not be found. For specific network configuration operations, please refer to the electronic manual.

DISPOSAL OF THE APPLIANCE

It is prohibited to dispose of this appliance as household waste.

Packaging materials

Packaging materials with the recycle symbol are recyclable. Dispose of the packaging into a suitable waste collection container to recycle it.

Before disposal of the appliance

1. Pull out the mains plug from the mains socket.
2. Cut off the power cord and discard with the mains plug.

DANGER

Risk of child entrapment. Before you throw away your old refrigerator or freezer:

- Take off the doors.
- Leave the shelves in place so that children may not easily climb inside.

WARNING

Appliances contain refrigerant and gases in the insulation. Refrigerant and gases must be disposed of professionally as they may cause eye injuries or ignition. Ensure that tubing of the refrigerant circuit is not damaged prior to proper disposal.



Correct Disposal of this product

This marking indicates that this product should not be disposed with other household wastes throughout the EU. To prevent possible harm to the environment or human health from uncontrolled waste disposal, recycle it responsibly to promote the sustainable reuse of material resources. To return your used device, please use the return and collection systems or contact the retailer where the product was purchased. They can take this product for environmentally safe recycling.

SUGGESTION OF USING THE APPLIANCE

To avoid contamination of food, please respect the following instructions:

- Opening the door for long periods can cause a significant increase of the temperature in the compartments of the appliance.
- Clean regularly surfaces that can come in contact with food and accessible drainage systems.
- Clean water tanks if they have not been used for 48h; flush the water system connected to a water supply if water has not been drawn for 5 days.(Special for models with water tanks)
- Store raw meat and fish in suitable containers in the refrigerator, so that it is not in contact with or drip onto other food.
- Two-star frozen-food compartments are suitable for storing pre-frozen food, storing or making ice-cream and making ice cubes.
- One-, two- and three-star compartments are not suitable for the freezing of fresh food.
- If the refrigerating appliance is left empty for long periods, switch off, defrost, clean, dry, and leave the door open to prevent mould developing within the appliance.
- **NOTE:** The information below is for reference only, as functions may vary by models. Please get more details in the E-manual.

Order	Compartments type	Target storage temp.[°C]	Appropriate food	Storage life
1	Fridge	+2~+8	Eggs, cooked food, packaged food, fruits and vegetables, dairy products, cakes, drinks and other foods which are not suitable for freezing.	/
2	Four-star	≤-18	Seafood, freshwater aquatic products and meats.	≤3 months
3	Three-star	≤-18		≤2 months
4	Two-star	≤-12		≤1 month
5	One-star	≤-6		
6	Zero-star	-6~0	Fresh pork, beef, fish, chicken, some packaged processed foods, etc.. Partially packed/wrapped up encapsulated processed foods (non-freezable foods)	≤3 days
7	Chill	-3~+3	Seafood, pork, beef, chicken, freshwater aquatic products, etc..	2~7 days
8	Fresh Food	0~+4	Fresh pork, beef, fish, chicken, cooked food, etc..	≤3 days
9	Wine	+5~+20	Red wine, white wine, sparkling wine etc.	/

Hisense

life reimagined

Hisense UK LTD

Ground floor Munroe Court
White Rose Office Park
Millshaw Park Lane
Leeds LS11 0EA

Customer support line (for UK mainland and Northern Ireland only): 0191 387 0804, Southern Ireland customers please contact your Retailer.