

Contents

1	Instructions	56
1.1	General safety instructions	56
1.2	Appliance purpose	60
1.3	Manufacturer's liability	60
1.4	This user manual	60
1.5	Disposal	61
1.6	Identification plate	61
1.7	How to read the user manual	62
1.8	To save energy	62
2	Description	63
2.1	General description	63
2.2	Control panel	64
2.3	Other parts	65
2.4	Available accessories	65
3	Use	67
3.1	Using the accessories	68
3.2	Using the oven	69
3.3	Cooking advice	76
3.4	Special functions	79
3.5	Settings	83
4	Cleaning and maintenance	87
4.1	Cleaning the surfaces	87
4.2	Cleaning the door	87
4.3	Cleaning the oven cavity	90
4.4	Vapor Clean (on some models only)	93
4.5	Pyrolytic function (on some models only)	96
4.6	Extraordinary maintenance	99
5	Installation	101
5.1	Electrical connection	101
5.2	Positioning	102

TRANSLATION OF THE ORIGINAL INSTRUCTIONS

We advise you to read this manual carefully, which contains all the instructions for maintaining the appliance's aesthetic and functional qualities.

For further information on the product: www.smeg.com



1 Instructions

1.1 General safety instructions



RISK OF INJURY

- During use the appliance and its accessible parts become very hot. Never touch the heating elements during use.
- Protect your hands by wearing oven gloves when moving food inside the oven.
- Never try to put out a fire or flames with water: Turn off the appliance and smother the flames with a fire blanket or other appropriate cover.
- This appliance may be used by children aged at least 8 and by people of reduced physical, sensory or mental capacity, or lacking in experience in the use of electrical appliances, provided that they are supervised or instructed by adults who are responsible for their safety.
- Children must not play with the appliance.
- Keep children under the age of eight at a safe distance unless they are constantly supervised.
- Keep children under the age of 8 away from the appliance when it is in use.
- Cleaning and maintenance must not be carried out by unsupervised children.
- The cooking process must always be monitored. A short cooking process must be continuously monitored.
- Never leave the appliance unattended during cooking operations where fats or oils could be released, as these could then heat up and catch fire. Be very careful.
- Do not pour water directly onto very hot trays.
- Keep the oven door closed during cooking.



- If you need to move food or at the end of cooking, open the door 5 cm for a few seconds, let the steam come out, then open it fully.
- Do not insert pointed metal objects (cutlery or utensils) into the slots in the appliance.
- Switch off the appliance immediately after use.
- DO NOT USE OR STORE FLAMMABLE MATERIALS NEAR THE APPLIANCE.
- DO NOT USE AEROSOLS IN THE VICINITY OF THIS APPLIANCE WHILST IT IS IN USE.
- DO NOT MODIFY THIS APPLIANCE.
- Installation and servicing should be carried out by qualified personnel in accordance with current standards.
- Do not try to repair the appliance yourself or without the assistance of a qualified technician.
- Do not pull the cable to unplug the appliance.



RISK OF DAMAGING THE APPLIANCE

- Do not use abrasive or corrosive detergents (e.g. scouring powders, stain removers and metallic sponges) on glass parts. Use wooden or plastic utensils.
- Do not use rough or abrasive materials or sharp metal scrapers.
- Do not sit on the appliance.
- Do not use cleaning products containing chlorine, ammonia or bleach on parts made of steel or that have metallic surface finishes (e.g. anodizing, nickel- or chromium-plating).



Instructions

- Racks and trays should be inserted as far as they will go into the side guides. The mechanical safety locks that prevent them from being removed must face downwards and towards the back of the oven cavity.

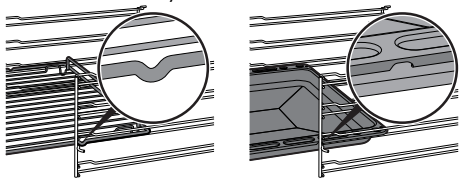

- Do not use steam jets to clean the appliance.
- Do not spray any spray products near the appliance.
- (on some models only) Before starting the pyrolytic cycle, remove any food residues or large spills from previous cooking operations from the inside of the oven.
- Do not obstruct ventilation openings and heat dispersal slots.
- Fire hazard: never leave objects in the oven cavity.
- DO NOT FOR ANY REASON USE THE APPLIANCE AS A SPACE HEATER.
- Do not use plastic cookware or containers when cooking food.
- Do not put sealed tins or containers in the oven.
- Remove all trays and racks which are not required during cooking.
- Do not cover the bottom of the oven cavity with aluminium or tin foil sheets.
- Do not place pans or trays directly on the bottom of the oven cavity.
- If you wish to use greaseproof paper, place it so that it will not interfere with the hot air circulation inside the oven.
- Do not use the open door to rest pans or trays on the internal glass pane.
- Never use the oven door to lever the appliance into place when fitting.



- Avoid exerting too much pressure on the oven door when open.
- Do not use the handle to lift or move the appliance.

Installation and maintenance

- THIS APPLIANCE **MUST NOT BE INSTALLED** IN BOATS OR CARAVANS.
- The appliance must not be installed on a pedestal.
- Position the appliance into the cabinet cut-out with the help of a second person.
- To avoid potential overheating, the appliance must not be installed behind a decorative door or a panel.
- Installation and servicing should be carried out by qualified personnel in accordance with current standards.
- Have the electrical connection performed by authorised technical personnel.
- The appliance must be connected to earth in compliance with electrical system safety standards.
- Use cables that can withstand temperatures of at least 90°C.
- The tightening torque of the screws of the terminal supply wires must be 1.5 - 2 Nm.
- If the power cable becomes damaged, contact technical support immediately to arrange for it to be replaced in order to avoid possible hazards.
- Always use any necessary/required personal protective equipment (PPE) before performing any work on the appliance (installation, maintenance, positioning or movement).
- Before performing any work on the appliance, switch off the power supply.
- This appliance can be used up to a maximum altitude of 2,000 metres above sea level.



For this appliance

- Ensure that the appliance is switched off before replacing the bulb.
- Do not rest any weight or sit on the open door of the appliance.
- Take care that no objects are stuck in the doors.
- Do not install / use the appliance outdoors.
- Only use the temperature probe provided or recommended by the manufacturer.

1.2 Appliance purpose

This appliance is intended for cooking food in the home environment. Every other use is considered improper. It must also not be used:

- In kitchen areas provided for employees in shops, offices and other work environments
- On farms/farm accommodation
- By guests in hotels, motels and other types of residential environments
- In bed and breakfast accommodation.

1.3 Manufacturer's liability

The manufacturer declines all liability for damage to persons or property caused by:

- Use of the appliance other than that specified
- Failure to comply with the instructions in the user manual
- Tampering with any part of the appliance
- The use of non-original spare parts.

1.4 This user manual

- This user manual is an integral part of the appliance and must therefore be kept in its entirety and within the user's reach for the whole working life of the appliance.
- Read this user manual carefully before using the appliance.
- The explanations in this manual include images, which describe all that regularly appears on the display. However, it should be kept in mind that the appliance may be equipped with an updated version of the system, and as such, all that appears on the display may differ from those in the manual.



1.5 Disposal



This appliance conforms to the WEEE European directive (2012/19/EU) and must be disposed of separately from other waste at the end of its service life.

The appliance does not contain substances in quantities sufficient to be considered hazardous to health and the environment, in accordance with current European directives.

To dispose of the appliance:

- Cut the power cable and remove it.



Power voltage

Danger of electrocution

- Disconnect the mains power supply.
- Unplug the appliance.
- Deliver the appliance to the appropriate recycling centre for electrical and electronic equipment waste, or return it to the retailer when purchasing an equivalent product, on a one for one basis.

Our appliances are packaged in non-polluting and recyclable materials.

- Deliver the packing materials to the appropriate recycling centre.



Plastic packaging

Danger of suffocation

- Do not leave the packaging or any part of it unattended.
- Do not let children play with the plastic bags.

1.6 Identification plate

The identification plate bears the technical data, serial number and brand name of the appliance. Do not remove the identification plate for any reason.



Instructions

1.7 How to read the user manual

This user manual uses the following reading conventions:



Instructions

General information on this user manual, on safety and final disposal.



Description

Description of the appliance and its accessories.



Use

Information on the use of the appliance and its accessories, cooking advice.



Cleaning and maintenance

Information for proper cleaning and maintenance of the appliance.



Installation

Information for the qualified technician: Installation, operation and inspection.



Safety instructions



Information / Advice

1.8 To save energy

- Only preheat the appliance if the recipe requires you to do so.
- Unless otherwise indicated on the package, defrost frozen foods before placing them in the oven.
- When cooking several types of food it is recommended to cook the foods one after the other to make the best use of the already hot oven.
- Use dark metal moulds: They help to absorb the heat better.
- Remove all trays and racks which are not required during cooking.
- Stop cooking a few minutes before the time normally used. Cooking will continue for the remaining minutes with the heat which has accumulated inside the oven.
- Reduce any opening of the door to a minimum to avoid heat dispersal.
- Keep the inside of the oven clean at all times.



2 Description

2.1 General description

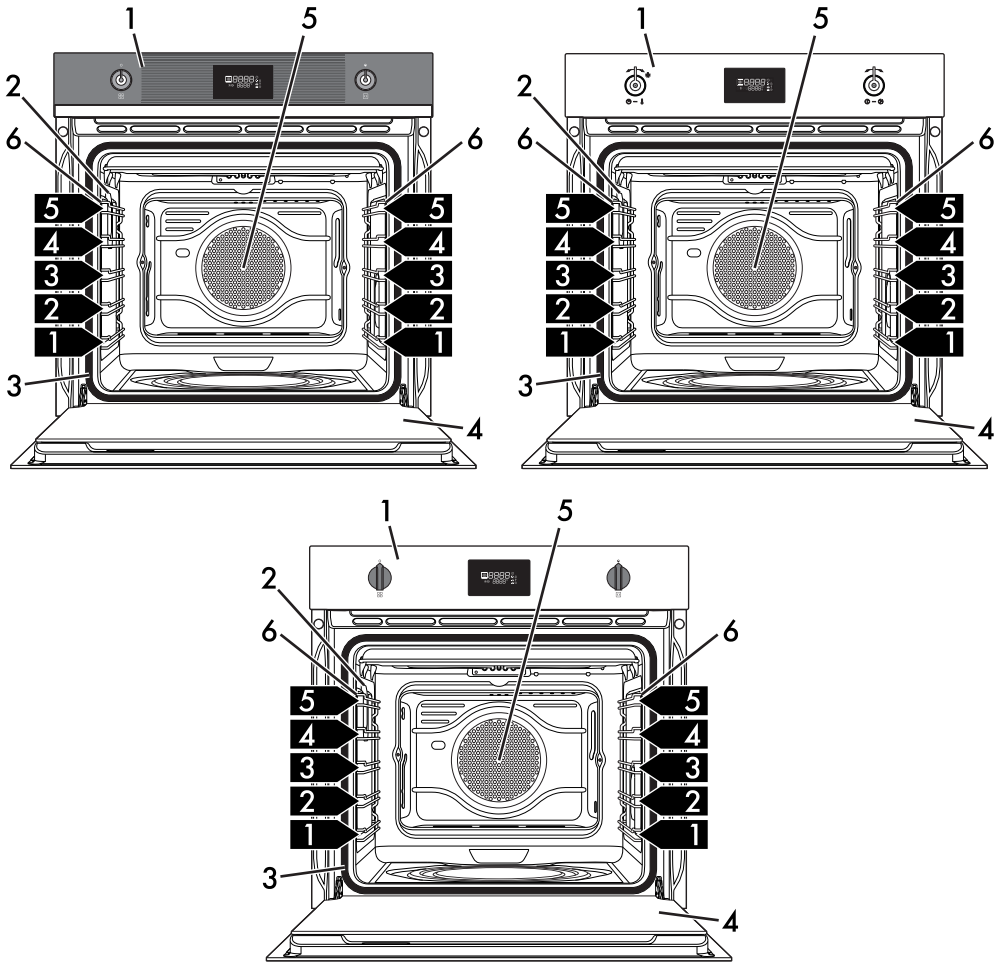

- 1 Control panel
- 2 Oven light
- 3 Seal
- 4 Door

- 5 Fan
- 6 Rack/tray support frames
- 1,2,3... Frame shelf

EN



Description

2.2 Control panel

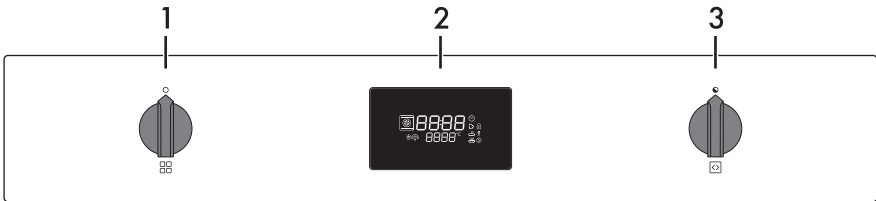
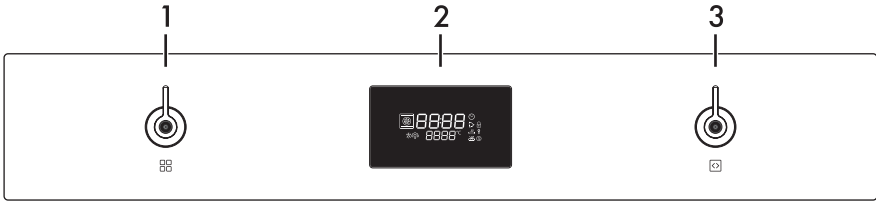
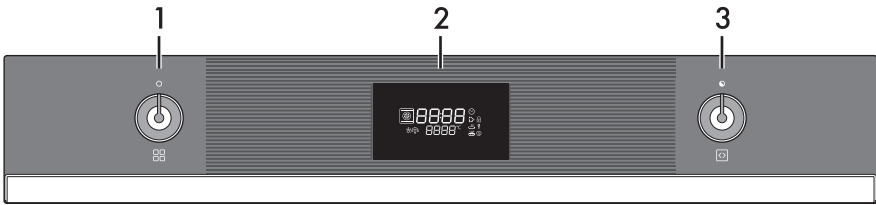

1 Function knob

This knob can be used to:

- Turn the appliance on and off
- Select a function.



Turn the **Function knob**  to **0** to terminate any cooking operation immediately.

3 Select knob

This knob can be used to set:

- The cooking temperature
- The duration of a function
- Programmed cooking procedures
- The current time
- Temporarily start or stop a function.

2 Display

Displays the current time, the function, the selected cooking temperature, power and any time that has been set.



2.3 Other parts

Interior lighting

The appliance's interior lighting comes on:

- When the door is opened.
- When any function, apart from the ECO **ECO**, Pyrolytic **Pyro** and Vapor Clean **CLEAR** functions are selected (depending on the model).



When the door is open, it is not possible to turn off the interior lighting.

Cooling fan

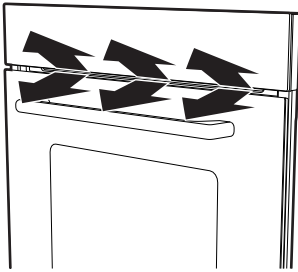

The fan cools the appliance and comes into operation during cooking. The fan causes a steady outflow of air from above the door which may continue for a brief period of time even after the appliance has been turned off.

Shelves

The appliance features shelves to position trays and racks at different heights. The insertion heights are indicated from the bottom upwards (see 2.1 General description).

2.4 Available accessories

Rack

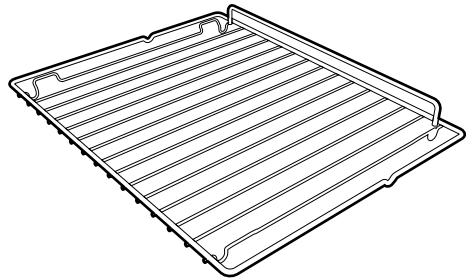

Useful for supporting containers with food during cooking.

Tray rack (on some models only)

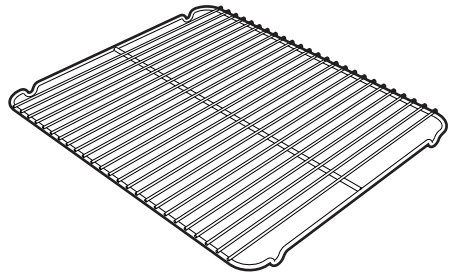

To be placed over the top of the oven tray; for cooking foods which may drip.



Description

Oven tray (on some models only)

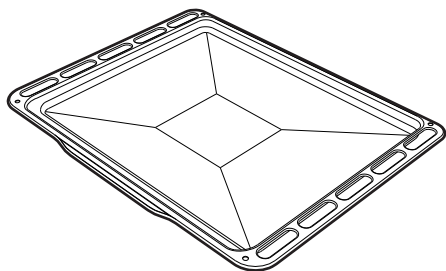

Useful for collecting fat from foods placed on the rack above and for cooking sweets, biscuits, etc.

Deep tray

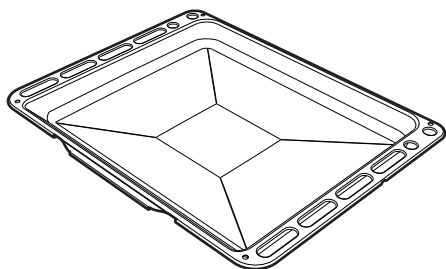

Useful for collecting fat from foods placed on the rack above and for cooking pies, pizzas and baked desserts.

Self-cleaning panels (on some models only)

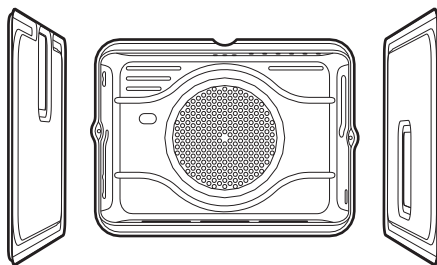

Useful for absorbing small grease residues.



Some models are not provided with all accessories.



The oven accessories intended to come into contact with food are made of materials that comply with the provisions of current legislation.



Original supplied and optional accessories can be requested to Authorised Assistance Centres. Use only original accessories supplied by the manufacturer.



3 Use

Instructions



High temperature inside the oven during use
Danger of burns

- Keep the oven door closed during cooking.
- Protect your hands by wearing oven gloves when moving food inside the oven.
- Do not touch the heating elements inside the oven.
- Do not pour water directly onto very hot trays.
- Do not allow children to approach the oven when it is in operation.



Improper use
Risk of damage to enamelled surfaces

- Do not cover the bottom of the oven cavity with aluminium or tin foil sheets.
- If you wish to use greaseproof paper, place it so that it will not interfere with the hot air circulation inside the oven.
- Do not place pans or trays directly on the bottom of the oven cavity.
- Do not pour water directly onto very hot trays.



High temperature inside the oven during use
Danger of fire or explosion

- Do not spray any spray products near the appliance.
- Do not use or leave flammable materials near the appliance.
- Do not use plastic cookware or containers when cooking food.
- Do not put sealed tins or containers in the oven.
- Do not leave the appliance unattended during cooking operations where fats or oils could be released.
- Remove all trays and racks which are not required during cooking.

Preliminary operations

1. Remove any protective film from the outside or inside of the appliance, including accessories.
2. Remove any labels (apart from the technical data plate) from the accessories and from the oven cavity.
3. Remove and wash all the appliance's accessories (see **4 Cleaning and maintenance**).
4. Heat the empty oven at the maximum temperature to burn off any residues left by the manufacturing process.



Use

3.1 Using the accessories

Tray rack

The tray rack has to be inserted into the tray. In this way fat can be collected separately from the food which is being cooked.

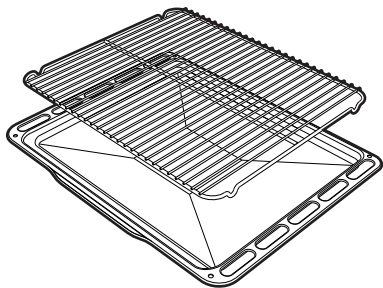

Racks and trays

Racks and trays have to be inserted into the side guides until they come to a complete stop.

- The mechanical safety locks that prevent the rack from being removed accidentally must face downwards and towards the back of the oven.

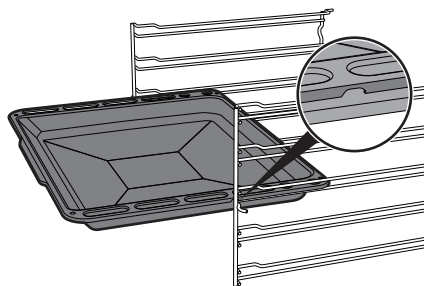
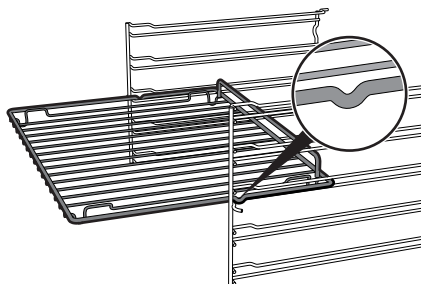

Gently insert racks and trays into the oven until they come to a stop.





Clean the trays before using them for the first time to remove any residues left by the manufacturing process.











3.2 Using the oven

Display





The parameters and values for the currently selected function will be indicated on the display. To use it, simply turn the **Function**  and **Select**  knobs to select the values displayed.



-  Clock indicator light
-  Timer indicator light
-  Cooking indicator light
-  End of cooking indicator light
-  Door lock indicator light (pyrolytic models only)
-  Controls lock indicator light
-  Showroom indicator light
-  Defrost indicator light
-  Vapor Clean indicator light (excluding pyrolytic models)

First use

When using the appliance for the first time or after a prolonged power failure, **00:00** will flash on the display. In order to start a cooking function, the current time has to be set.

1. Turn the **Select knob**  to select the current time.
2. Press the **Select knob**  to set the hours and go to the minutes.
3. Turn the **Select knob**  to select the minutes.
4. Press the **Select knob**  to finish setting the time.



It may be necessary to change the current time, for example for daylight saving time. To modify the current time, see "3.5 Settings".



When the current time is shown, the display will be dimmed 2 minutes after the knobs were last used.





Use



Timer



This function only activates the buzzer when the countdown ends.

1. When the **Function knob**  is on position **0**, press the **Select knob** .





Digits  appear on the display and the **Timer indicator light**  flashes.

2. Turn the **Select knob**  within 3 seconds to set the duration of the **Timer** (from 1 minute to 13 hours).
3. Wait 3 seconds or press the **Select knob**  to start the **Timer**.







During this function, the display will be dimmed 2 minutes after the knobs were last used.

Timer End





4. When the timer ends, digits  and the **Timer indicator light**  flash and a buzzer will sound briefly that can be deactivated by pressing the **Select knob**  or by opening the door.
5. Turn the **Select knob**  to select another timer or press the **Select knob**  to exit from the **Timer** function and go back to the current time display.

How to clear a Timer

1. Press the **Select knob** .
- The **Timer indicator light**  flashes on the display.
2. Turn the **Select knob**  anticlockwise within 3 seconds to reset the timer.
 3. Wait 3 seconds or press the **Select knob**  to exit from the **Timer** function and go back to the current time display.



Switching on the oven

1. Turn the **Function knob**  to the right or left to select the required function (e.g. "FAN ASSISTED" ).
2. Turn the **Select knob**  to the right or left to select the required temperature (e.g. "200°C").
3. Wait 3 seconds to start cooking or press the **Select knob**  to enter settings for the cooking duration or the end of cooking time.



When the door is opened, the function in progress is stopped (the **Cooking indicator light**  turns off).

The function restarts automatically when the door is closed.

Pre-heating stage

Cooking is preceded by a preheating stage, which allows the appliance to heat to the cooking temperature more quickly.

The **Cooking indicator light**  flashes to indicate that this stage is in progress.

When the preheating stage is over, the

Cooking indicator light  will remain lit steadily and a buzzer will sound to indicate that the food can be placed in the oven.



Cooking can be interrupted at any time by turning the **Function knob**  to 0.



Use

Timed Cooking





Timed cooking is the function which allows you to start cooking and end it after a specific length of time set by the user.



If **Timed cooking** is activated, it cancels any minute minder timer that may have been set previously.

1. After having selected a cooking function and a temperature, press the **Select knob** .

Digits  appear on the display and the **Cooking**  and **Clock**  indicator lights flash.



2. Turn the **Select knob**  within 3 seconds to set the cooking duration (from 1 minute to 13 hours) (e.g. "25 minutes").



3. Wait 3 seconds.

The **Cooking indicator light**  stops flashing and **Timed cooking** starts.



Timed cooking does not take pre-heating times into account.





End of timed cooking

4. At the end of cooking, **STOP**  flashes on the display and a buzzer will sound that can be deactivated by opening the door or pressing/turning one of the two knobs.



To select another **Timed cooking**, turn the **Select knob**  right or left again.

How to clear Timed Cooking

1. Press the **Select knob** .
- The **Cooking indicator light**  flashes on the display.
2. Turn the **Select knob**  anticlockwise within 3 seconds to reset the cooking duration.
 3. Wait 3 seconds or press the **Select knob**  to exit from the **Timed Cooking** function and go back to the current time display.



Timer during cooking



This function only activates the buzzer, without stopping cooking.



It is not possible to set a **Timer during cooking** if **Timed cooking** has previously been selected.

1. After having selected a cooking function and a temperature, press the **Select knob**  twice.

Digits  appear on the display and the **Timer indicator light**  flashes.



It is possible to set a **Timer** even when cooking has already started.



2. Turn the **Select knob**  within 3 seconds to set the duration of the **Timer** (from 1 minute to 13 hours).
3. Wait 3 seconds.

The **Timer indicator light**  stops flashing and the **Timer** starts.

Timer end during cooking

4. Wait for the buzzer to indicate that the time has finished.

Digits  and the **Timer indicator light**  flash.

5. Turn the **Select knob**  to select another timer or press the **Select knob**  to deactivate the buzzer and exit from the **Timer during cooking** function.

After a few seconds, the current time appears on the display and the cooking in progress continues.

To clear a Timer during cooking

1. During cooking, press the **Select knob**  twice.

The **Timer indicator light**  flashes on the display.

2. Turn the **Select knob**  anticlockwise within 3 seconds to reset the timer.
3. Wait 3 seconds to exit from the **Timer during cooking** function.



Use

Programmed Cooking





Programmed Cooking is the function that allows **Timed Cooking** to be stopped automatically at a time set by the user, after which the appliance will switch off automatically.



For safety reasons, it is not possible to set the end of cooking time by itself without setting the cooking duration.

1. After having selected a cooking function and a temperature, press the **Select knob** .

Digits **00:00** appear on the display and the **Cooking**  and **Clock**  indicator lights flash.



2. Turn the **Select knob**  within 3 seconds to set the cooking duration (from 1 minute to 13 hours) (e.g. "25 minutes").



3. Press the **Select knob** .

Digits **00:00** appear on the display and the **End of Cooking**  and **Clock**  indicator lights flash.

4. Turn the **Select knob**  within 3 seconds to set the end of cooking time (for example "13:15").



5. Wait 3 seconds.

The **End of cooking indicator light**  and the appliance wait for the set start time.



The minutes required for pre-heating are already included in the end-of-cooking time.



Programmed Cooking End

At the end of cooking, **STOP** flashes on the display and a buzzer will sound that can be deactivated by opening the door or pressing/turning one of the two knobs.



How to clear Programmed Cooking

1. Press the **Select knob** .

The **Cooking indicator light**  flashes on the display.

2. Turn the **Select knob**  clockwise or anticlockwise within 3 seconds to set a new **Timed Cooking**.

Programmed Cooking has now been cleared.



Cooking can be interrupted at any time by turning the **Function knob**  to **0**.

List of cooking functions



STATIC

Traditional cooking, ideal for preparing a single dish. For example cooking roast meats, fatty meats, bread, pies.



FAN ASSISTED

Intense and uniform cooking. Ideal for biscuits, cakes and cooking on more than one level.



CIRCULAIRE

The heat is distributed quickly and uniformly. Suitable for all dishes, ideal for cooking on multiple levels without mixing smells or flavours.



TURBO

Allows rapid cooking on multiple levels without mixing aromas. Ideal for large volumes of food or intense cooking.



GRILL

Produces excellent grilling and gratinating results. When used at the end of cooking, gives a uniform browning to dishes.



FAN WITH GRILL

Allows optimal grilling, even for thick slices of meat. Perfect for larger cuts of meat.



Use



BOTTOM

The heat comes from the bottom of the cavity. Perfect for cakes, pies, tarts and pizzas.



CIRCULAIRE + BOTTOM

Allows you to quickly finish cooking food that is already cooked on the surface but not internally. Ideal for quiches, suitable for all kinds of dishes.



ECO

Low energy cooking: this function is particularly suitable for cooking on a single shelf with low energy consumption.

It is recommended for all types of food except those that may produce a large amount of moisture (e.g. vegetables).

To obtain maximum energy savings and reduce cooking times, it is recommended to place food in the oven without preheating.



When using the **ECO** function, avoid opening the door during cooking.



Cooking times are longer with the **ECO** function.



The **ECO** function is a delicate cooking function and is recommended for cooking that does not require temperatures higher than 200°C. It is recommended that you select a different function for cooking at higher temperatures.



PIZZA

Function designed for cooking pizza. Perfect not just for pizzas, but also for biscuits and cakes.



For the **PIZZA**  function see "3.4 Special functions".

3.3 Cooking advice

General advice

- Use a fan assisted function to achieve consistent cooking at several levels.
- It is not possible to shorten cooking times by increasing the temperature (the food could be overcooked on the outside and undercooked on the inside).
- To prevent condensation from forming on the glass, hot food should not be left inside the oven for too long after cooking.



Advice for cooking meat

- Cooking times vary according to the thickness and quality of the food and to consumer taste.
- Use a meat thermometer when roasting meat, or simply press on the roast with a spoon. If it is hard, it is ready; if not, it needs to be cooked for a few more minutes.
- For meat and potatoes, it is recommended to turn and / or mix the food from time to time in order to obtain a uniform browning on all sides.
- For slow cooking, brown the meat in a pan for a few minutes on all sides before cooking in the oven.

Advice for cooking with the Grill and the Fan with grill

- Meat can be grilled even when it is put into the cold oven or into the preheated oven if you wish to change the effect of the cooking.
- It is recommend that you preheat the oven before grilling when using the Fan with grill function.
- We recommend placing the food at the centre of the rack.

Advice for cooking desserts/pastries and biscuits

- Use dark metal moulds: They help to absorb the heat better.
- The temperature and the cooking time depend on the quality and consistency of the dough.
- To check whether the dessert is cooked right through: At the end of the cooking time, put a toothpick into the highest point of the dessert. If the dough does not stick to the toothpick, the dessert is cooked.
- If the dessert collapses when it comes out of the oven, on the next occasion reduce the set temperature by about 10°C, selecting a longer cooking time if necessary.

Advice for defrosting and proving

- Place frozen foods without their packaging in a lidless container on the first shelf of the oven.
- Avoid overlapping the food.
- To defrost meat, use the rack placed on the second level and a tray on the first level. In this way, the liquid from the defrosting food drains away from the food.
- The most delicate parts can be covered with aluminium foil.
- For successful proving, a container of water should be placed in the bottom of the oven.



Use

Cooking information table

Food	Weight (Kg)	Function	Shelf	Temperature (°C)	Time (minutes)	
Lasagne	3 - 4	Static	1	220 - 230	45 - 50	
Pasta bake	3 - 4	Static	1	220 - 230	45 - 50	
Veal roast	2	Turbo/Fan assisted	2	180 - 190	90 - 100	
Pork loin	2	Turbo/Fan assisted	2	180 - 190	70 - 80	
Sausages	1.5	Fan with grill	4	280	15	
Roast beef	1	Turbo/Fan assisted	2	200	40 - 45	
Roast rabbit	1.5	Circulaire/Fan assisted	2	180 - 190	70 - 80	
Turkey breast	3	Turbo/Fan assisted	2	180 - 190	110 - 120	
Roast pork neck	2 - 3	Turbo/Fan assisted	2	180 - 190	170 - 180	
Roast chicken	1.2	Turbo/Fan assisted	2	180 - 190	65 - 70	
					1st surface	2nd surface
Pork chops	1.5	Fan with grill	4	280	15	5
Spare ribs	1.5	Fan with grill	4	280	10	10
Bacon	0.7	Grill	5	280	7	8
Pork fillet	1.5	Fan with grill	4	280	10	5
Beef fillet	1	Grill	5	280	10	7
Salmon trout	1.2	Turbo/Fan assisted	2	150 - 160	35 - 40	
Monkfish	1.5	Turbo/Fan assisted	2	160	60 - 65	
Turbot	1.5	Turbo/Fan assisted	2	160	45 - 50	
Pizza	1	Turbo/Fan assisted	2	280	8 - 9	
Bread	1	Circulaire/Fan assisted	2	190 - 200	25 - 30	
Focaccia	1	Turbo/Fan assisted	2	180 - 190	20 - 25	
Bundt cake	1	Circulaire/Fan assisted	2	160	55 - 60	
Tart	1	Circulaire/Fan assisted	2	160	35 - 40	
Ricotta cake	1	Circulaire/Fan assisted	2	160 - 170	55 - 60	
Jam tarts	1	Turbo/Fan assisted	2	160	20 - 25	
Paradise cake	1.2	Circulaire/Fan assisted	2	160	55 - 60	
Profiteroles	1.2	Turbo/Fan assisted	2	180	80 - 90	
Sponge cake	1	Circulaire/Fan assisted	2	150 - 160	55 - 60	
Rice pudding	1	Turbo/Fan assisted	2	160	55 - 60	
Brioches	0.6	Circulaire/Fan assisted	2	160	30 - 35	

The times indicated in the table do not include preheating times and are provided only as a guide.



3.4 Special functions

Defrost



This function allows you to defrost food on the basis of a selectable time.

1. Place the food inside the oven.
2. Turn the **Function knob**  until the following appears on the display.





3. Press the **Select knob**  to confirm that you wish to use the Special functions. The **Defrost** function screen appears on the display.



4. Press the **Select knob**  to confirm the **Defrost** function.

Digits  appear on the display and the **Defrost indicator light**  and the  icon flash.



5. Turn the **Select knob**  to set the **Defrost** duration (from 1 minute to 13 hours) (for example "01:30").
6. Wait 3 seconds or press the **Select knob**  to start defrosting.



Defrost End

At the end of the **Defrost** cycle, **STOP** flashes on the display and a buzzer will sound that can be deactivated by opening the door or pressing/turning one of the two knobs.



7. Turn the **Function knob**  to **0** to exit from the function.



Use

Proving



For successful proving, a container of water should be placed in the bottom of the oven.

1. Position the dough to prove on the second level.
2. Turn the **Function knob**  until the following appears on the display.





3. Press the **Select knob**  to confirm that you wish to use the Special functions. The **Defrost** function screen appears on the display.



4. Turn the **Select knob**  to select the **Proving** function.



5. Press the **Select knob**  to confirm the **Proving** function.
6. Wait 3 seconds to start the function, or press the **Select knob**  to enter the settings for the function duration, end time etc.



7. Turn the **Function knob**  to 0 to exit from the function.



Sabbath



This function results in the appliance operating in a particular way:

- Cooking can proceed indefinitely, it is not possible to set any cooking duration.
- No preheating will be performed.
- The cooking temperature which can be selected varies between 60-100 °C.
- Oven light disabled, any operation such as opening the door (where present) or manual activation with the knob will not activate the light.
- The internal fan remains turned off.
- Knob illumination and audible prompts remain disabled.



After activating the Sabbath function the settings cannot be altered.

Any action on the knobs will produce no effect; only the

Function Knob  remains active to allow you to return to the main menu.

1. Place the food inside the oven.
2. Turn the **Function knob**  until the following appears on the display.



3. Press the **Select knob**  to confirm that you wish to use the Special functions. The **Defrost** function screen appears on the display.



4. Turn the **Select knob**  to select the **Sabbath** function.



5. Press the **Select knob**  to confirm the **Sabbath** function.





Use

- Turn the **Select knob**  to select the required temperature (from 60°C to 100°C) (for example "90°C").
- Wait 3 seconds before starting the function.



- Turn the **Function knob**  to **0** to exit from the function.



For the **Vapor Clean** and **Pyrolytic** functions (depending on the model) see "4 Cleaning and maintenance".

PIZZA function



Function designed for cooking pizza. Perfect not just for pizzas, but also for biscuits and cakes.

- Turn the **Function knob**  until the following appears on the display.





- Press the **Select knob**  to confirm that you wish to use the Special functions.

The **Defrost** function screen appears on the display.



- Turn the **Select knob**  to select the **PIZZA** function.



- Press the **Select knob**  to confirm the **PIZZA** function.
- Wait 3 seconds to start the function or press the **Select knob**  to enter the settings for temperature, duration, end of cooking time etc.



- Turn the **Function knob**  to **0** to exit from the function.



3.5 Settings

Current time

1. Turn the Function knob  until the following appears on the display.



2. Press the Select knob  to access the list of Settings.

The **Current time** function screen appears on the display.



3. Press the Select knob  to adjust the Current Time (for example "12:30").



4. Turn the Select knob  to select the current time.



5. Press the Select knob  to set the hours and go to the minutes.



6. Turn the Select knob  to select the minutes.

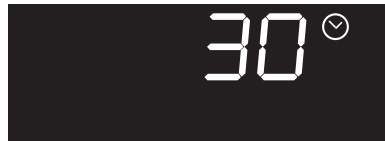

7. Press the Select knob  to finish setting the time.



8. Turn the Select knob  to select a new Setting.



Use

Controls lock (Child Safety)



This mode allows the appliance to lock the controls automatically after one minute of normal operation without any intervention from the user.

1. Turn the **Function knob**  until the following appears on the display.



2. Press the **Select knob**  to access the list of **Settings**.

The **Current time** function screen appears on the display.



3. Turn the **Select knob**  to select the **Controls lock** function.



4. Press the **Select knob**  to confirm.

5. Turn the **Select knob**  to activate the **Controls lock** function.



6. Press the **Select knob**  to confirm.

7. Turn the **Select knob**  to select a new **Setting**.



During normal operation, the **Controls lock** is indicated by the **Controls lock indicator light**  turning on.



If the knobs are touched or their position changed, **bLOC** will appear on the display for two seconds.



To disable the lock temporarily during cooking, keep the **Select knob**  pressed for 5 seconds. One minute after the last setting the lock will become active again.



Showroom (for exhibitors only)



This mode allows the appliance to deactivate all heating elements, while keeping the control panel active.

1. Turn the **Function knob**  until the following appears on the display.





2. Press the **Select knob**  to access the list of **Settings**.

The **Current time** function screen appears on the display.





3. Turn the **Select knob**  to select the **Showroom** function.



4. Press the **Select knob**  to confirm.
5. Turn the **Select knob**  to activate the **Showroom** function.



6. Press the **Select knob**  to confirm.
7. Turn the **Select knob**  to select a new **Setting**.



When the **Showroom** function is active, the **Showroom indicator light**  is lit on the display.



To use the appliance normally, set this function to **OFF**.



Use

Keep Warm



This mode allows the appliance to keep cooked food warm (at low temperatures) after cooking finishes with a cooking cycle for which a duration has been set (if this is not manually interrupted), without altering the taste and smell obtained during cooking.

1. Turn the **Function knob**  until the following appears on the display.





2. Press the **Select knob**  to access the list of **Settings**.

The **Current time** function screen appears on the display.





3. Turn the **Select knob**  to select the **Keep warm** function.



4. Press the **Select knob**  to confirm.
5. Turn the **Select knob**  to activate the **Showroom** function.



6. Press the **Select knob**  to confirm.
7. Turn the **Select knob**  to select a new **Setting**.



To use the appliance normally, set this function to **OFF**.



4 Cleaning and maintenance

Instructions



Improper use Risk of damage to surfaces

- Do not use steam jets to clean the appliance.
- Do not use cleaning products containing chlorine, ammonia or bleach on parts made of steel or that have metallic surface finishes (e.g. anodizing, nickel- or chromium-plating).
- Do not use abrasive or corrosive detergents (e.g. scouring powders, stain removers and metallic sponges) on glass parts.
- Do not use rough or abrasive materials or sharp metal scrapers.

4.1 Cleaning the surfaces

To keep the surfaces in good condition, they should be cleaned regularly after use. Let them cool first.

Ordinary daily cleaning

Always and only use specific products that do not contain abrasives or chlorine-based acids.

Pour the product onto a damp cloth and wipe the surface, rinse thoroughly and dry with a soft cloth or a microfibre cloth.

Food stains or residues

Do not use steel sponges and sharp scrapers as they will damage the surface.

Use normal, non-abrasive products and a wooden or plastic tool, if necessary. Rinse thoroughly and dry with a soft cloth or a microfibre cloth.

Do not allow residues of sugary foods (such as jam) to set inside the oven. If left to set for too long, they might damage the enamel lining of the oven.

4.2 Cleaning the door

Removing the door

For easier cleaning it is recommended to remove the door and place it on a tea towel.

To remove the door proceed as follows:

1. Open the door completely and insert two pins into the holes on the hinges indicated in the figure.

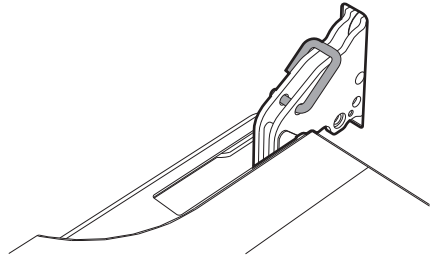



Cleaning and maintenance

2. Grasp the door on both sides with both hands, lift it so that it forms an angle of around 30° and remove it.

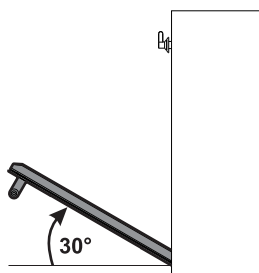

3. To reassemble the door, put the hinges in the relevant slots in the oven, making sure that grooved sections **A** are resting completely in the slots. Lower the door and once it is in place remove the pins from the holes in the hinges.

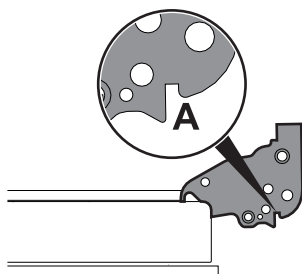

Cleaning the door glazing

The glass in the door should always be kept thoroughly clean. Use absorbent kitchen roll. In case of stubborn dirt, wash with a damp sponge and an ordinary detergent.



We recommend the use of cleaning products distributed by the manufacturer.

Removing the internal glass panes

For easier cleaning the internal glass panes of the door can be removed.

1. Remove the internal glass pane by pulling the rear part gently upwards, following the movement indicated by the arrows (1).
2. Then, pull the front part upwards (2). This way, the 4 pins attached to the glass detach from their housings in the oven door.

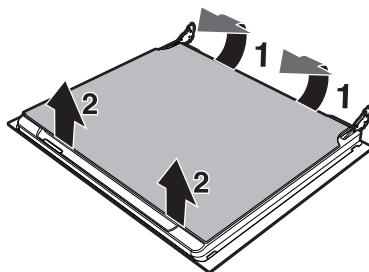

Cleaning and maintenance



3. Some models have an intermediate glass pane. Remove the intermediate glass pane by lifting it upwards.

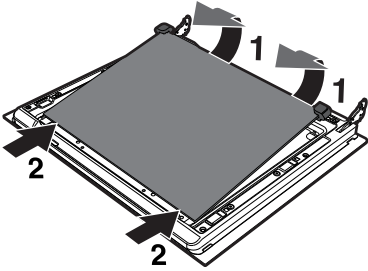

4. Clean the external glass pane and the panes removed previously. Use absorbent kitchen roll. In case of stubborn dirt, wash with a damp sponge and neutral detergent.

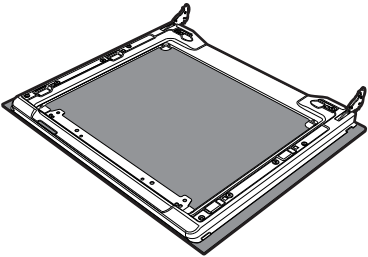

5. Refit the panes in the reverse order in which they were removed.
6. Reposition the internal glass pane. Take care to centre and insert the 4 pins into their housings in the oven door by applying slight pressure.

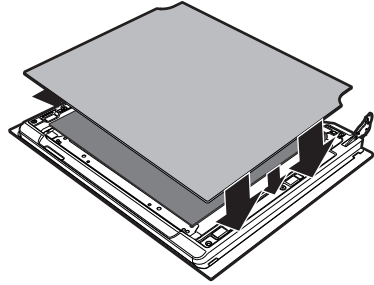

EN



Cleaning and maintenance

4.3 Cleaning the oven cavity

In order to keep your oven in the best possible condition, clean it regularly after letting it cool down.

Avoid letting food residue dry inside the oven cavity, as this could damage the enamel.

Take out all removable parts before cleaning.

For easier cleaning, we recommend removing:

- The door
- The rack/tray support frames
- The oven seal.

Drying

Cooking food generates moisture inside the appliance. This is a normal phenomenon and does not affect the appliance's operation in any way.

Each time you finish cooking:

1. Let the appliance cool down.
2. Remove any dirt from inside the appliance.
3. Dry the interior of the appliance with a soft cloth.
4. Leave the door open until the inside of the appliance has dried completely.



In the event you are using specific cleaning products, we recommend running the oven at maximum temperature for 15-20 minutes in order to eliminate any residue.



Removing rack/tray support frames

Removing the rack/tray support frames enables the sides to be cleaned more easily. This operation should be performed each time the automatic cleaning cycle is used (on some models only).

To remove the rack/tray support frames:

1. Pull the frame towards the inside of the oven cavity to unhook it from groove **A**.
2. Then slide it out of the seats at the back **B**.
3. When cleaning is complete, repeat the above procedures to put the rack/tray support frames back in.

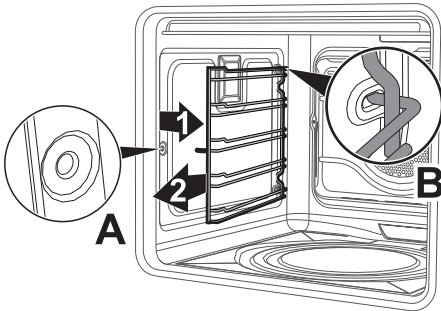

Removing self-cleaning panels and rack/tray support frames (fitted only to some models)

Removing the self-cleaning panels and the rack/tray support frames enables the sides to be cleaned more easily.

To remove the rack/tray support frames:

1. Pull the frame towards the inside of the oven cavity to unhook it from groove **A**.
2. Then slide it out of the seats at the back **B**.
3. When cleaning is complete, repeat the above procedures to put the rack/tray support frames back in.

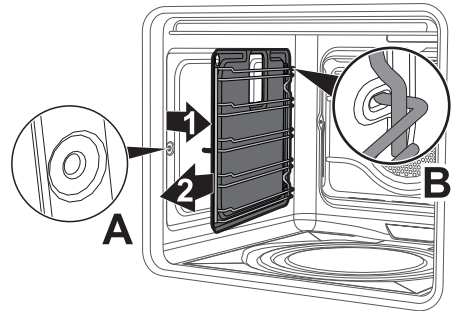



Cleaning and maintenance

Regeneration of self-cleaning panels (catalytic cycle) (on some models only)

The regeneration cycle of the self-cleaning panels is a cleaning method through heating suitable for removing small grease residues, not sugar-based ones.

1. Clean the base and the upper guard first (where fitted) with a microfibre cloth soaked in water and neutral washing up liquid. Rinse thoroughly.
2. Set a regeneration cycle by selecting a fan assisted function at the maximum temperature for one hour.
3. If the panels are particularly dirty, after the regeneration cycle, remove them and wash them with neutral washing up liquid. Rinse and dry them.
4. Put the panels back in the oven and set a fan assisted function at a temperature of 180°C for one hour, in order to ensure that they are thoroughly dry.



We recommend carrying out the self-cleaning panel regeneration cycle every 15 days.

Cleaning the roof of the oven (on some models only)



High temperature inside the oven during use

Danger of burns

- The following operations must be performed only with the oven switched off and completely cool.

The appliance is equipped with a tilting grill element that allows for easy cleaning of the roof of the oven cavity.

1. Free the upper heating element by gently lifting it and rotating its retaining latch by 90 degrees.

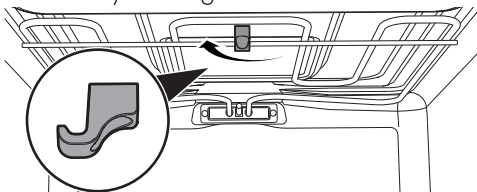

2. Gently lower the heating element until it stops.

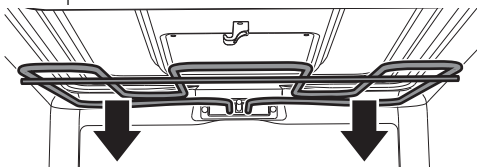

Improper use

Risk of damage to the appliance

- Do not excessively flex the element during cleaning.
3. When you have finished cleaning, place the heating element back in position and turn the retaining latch to lock it in place.



4.4 Vapor Clean (on some models only)



The **Vapor Clean** function is an assisted cleaning procedure that facilitates the removal of dirt. Thanks to this process, it is possible to clean the inside of the oven very easily. The dirt residues are softened by the heat and water vapour for easier removal afterwards.



Improper use Risk of damage to surfaces

- Remove any food residues or large spills from previous cooking operations from the inside of the oven.
- Carry out assisted oven cleaning operations only when the oven is cold.

Preliminary operations

Before starting the **Vapor Clean** cycle:

- Completely remove all accessories from inside the oven.
- Remove the self-cleaning panels, if present (see "**Removing self-cleaning panels and rack/tray support frames (fitted only to some models)**").
- Pour approx. 40 cc of water onto the floor of the oven. Make sure it does not overflow out of the cavity.

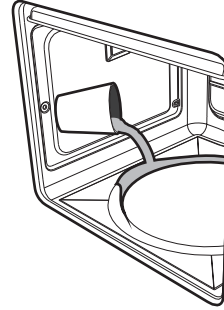

- Spray a water and washing up liquid solution inside the oven using a spray nozzle. Direct the spray towards the side walls, upwards, downwards and towards the deflector.

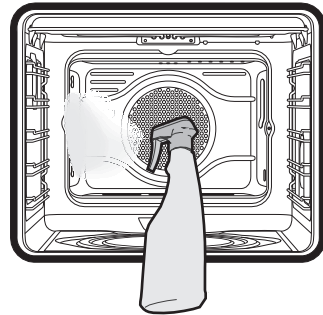

We recommend spraying approx. 20 times at the most.

- Close the door.
- During the assisted cleaning cycle, wash the self-cleaning panels (where fitted), which were previously removed, separately in warm water and a small amount of detergent.



Cleaning and maintenance

Vapor Clean cycle setting



If the internal temperature is greater than the one required, the function will be stopped immediately and the following message appears on the display:



Let the appliance cool down before activating the function.

1. Turn the **Function knob**  until the following appears on the display.



2. Press the **Select knob**  to confirm that you wish to use the Special functions. The **Defrost** function screen appears on the display.



3. Turn the **Select knob**  to select the **Vapor Clean** function.



4. Press the **Select knob**  to confirm the **Vapor Clean** function.



The duration and temperature parameters cannot be changed by the user.

5. Wait 3 seconds before starting the function.







6. At the end of the **Vapor Clean** cycle, **STOP** appears on the display and a buzzer will sound that can be deactivated by opening the door or pressing/turning one of the two knobs.



7. Turn the **Function knob**  to **0** to exit from the function.

Programmed Vapor Clean cycle

It is possible to program the **Vapor Clean** function start time, like all other cooking functions.

1. After having selected the **Vapor Clean** function, turn the **Select knob**  (the **End of cooking indicator light**  turns on) to set the time at which you want the **Vapor Clean** function to end.
2. Wait 3 seconds before confirming the settings.

The appliance waits until the set start time to start the **Vapor Clean** function.

Vapor Clean End

1. Open the door and wipe away the less stubborn dirt with a microfibre cloth.
2. Use a non-scratch sponge with brass filaments on hard to remove deposits.
3. In case of grease residues use specific oven cleaning products.
4. Remove the residual water inside the oven.
5. If fitted, replace the self-cleaning panels and the rack/tray support frames.

For greater hygiene and to avoid foods taking on unpleasant odours:

- We recommend drying the inside of the oven with a fan assisted function at 160°C for around 10 minutes.
- If self-cleaning panels are fitted, we recommend that you dry the inside of the oven with a simultaneous catalytic cycle (see "**Regeneration of self-cleaning panels (catalytic cycle) (on some models only)**").



We recommend wearing rubber gloves for these operations.



We recommend removing the door in order to make the manual cleaning of the parts that are difficult to reach easier.



Cleaning and maintenance

4.5 Pyrolytic function (on some models only)



Pyrolytic cleaning is an automatic high-temperature cleaning procedure that causes dirt to dissolve. Thanks to this process, it is possible to clean the inside of the oven very easily.



Improper use Risk of injury

- When this function is in use, the surfaces could reach temperatures that are higher than usual.
- Keep children at a safe distance.



Improper use Risk of damage to surfaces

- Remove any food residues or large spills from previous cooking operations from the inside of the oven.
- Switch off the burners or electric hot plates if there is a hob installed above the oven.

Preliminary operations

Before starting the **Pyrolytic cycle**:

- Clean the internal glass pane following the usual cleaning instructions.
- Remove any food residues or large spills from previous cooking operations from the inside of the oven.

- Completely remove all accessories from inside the oven.
- For very stubborn encrustations spray an oven cleaning product onto the glass (read the warnings on the product); leave for 60 minutes, then rinse and dry the glass using kitchen roll or a microfibre cloth.
- Remove the temperature probe (if present).
- Remove the rack/tray support frames.
- Close the door.

Pyrolytic function setting

1. Turn the **Function knob**  until the following appears on the display.



2. Press the **Select knob**  to confirm that you wish to use the Special functions. The **Defrost** function screen appears on the display.





3. Turn the **Select knob**  until the **Pyrolytic** function is selected.



The duration of the **Pyrolytic cycle** appears on the display (factory set to **2 hours**).

4. Turn the **Select knob**  to set the duration of the Pyrolytic cycle from a minimum of **2 hours** to maximum of **3 hours**.



Recommended pyrolytic cycle duration:

- Light dirt: L01 - 02:00.
- Medium dirt: L02 - 02:30.
- Heavy dirt: L03 - 03:00.

5. Press the **Select knob**  to confirm the parameters.

6. Wait 3 seconds before starting the function.



Pyrolytic cycle

7. Approximately 2 minutes after the **Pyrolytic cycle** starts, the **Door lock indicator light**  comes on to indicate that the door is locked by a device that prevents it from being opened.





It is not possible to select any function once the door lock device has been activated.

8. At the end of the **Pyrolytic cycle**, **STOP** flashes on the display and a buzzer will sound that can be deactivated by opening the door or pressing/turning one of the two knobs.



The door remains locked until the temperature inside the oven returns to a safe level.

9. Wait for the oven to cool down (the **Door lock indicator light**  turns off).
10. Collect any residues that may have been deposited inside the oven cavity using a damp microfibre cloth.
11. Turn the **Function knob**  to **0** to exit from the function.



Cleaning and maintenance



During the **Pyrolytic cycle**, the fans produce a more intense noise due to a greater rotation speed. This is an absolutely normal operation, intended to provide more effective heat dispersal. At the end of the **Pyrolytic cycle**, the fans will continue to operate for long enough to prevent overheating the walls of adjacent units and the front of the oven.



During the first **Pyrolytic cycle**, unpleasant odours may be produced due to the evaporation of oily substances used in the manufacturing process. This is normal and will disappear after the first **Pyrolytic cycle**.



If the **Pyrolytic cycle** gives unsatisfactory results at the minimum duration, it is recommended to set a longer time for subsequent cleaning cycles.

Setting of a programmed Pyrolytic cycle

It is possible to program the **Pyrolytic cycle** start time like all other cooking functions.

1. Turn the **Function knob**  until the following appears on the display.



2. Press the **Select knob**  to confirm that you wish to use the Special functions. The **Defrost** function screen appears on the display.





3. Turn the **Select knob**  until the **Pyrolytic** function is selected.



The duration of the **Pyrolytic cycle** appears on the display.



4. Press the Select knob 
5. Turn the Select knob  (the End of Cooking Indicator light  turns on) to set the time at which you want the **Pyrolytic** cycle to end.
6. Wait 3 seconds before confirming the settings.
7. The appliance waits until the set start time to start the **Pyrolytic** cycle.



It is not possible to select any function once the door lock device has been activated. It is anyway possible to switch off the appliance by moving the **Function**

Knob  to 0.

4.6 Extraordinary maintenance

Removing and installing the door seal (not on pyrolytic models)

To remove the seal:

- Release the clips located in the 4 corners and pull the seal outwards.

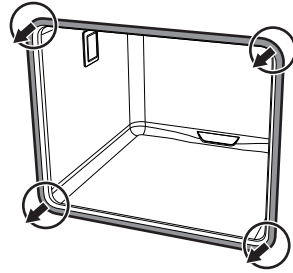

To refit the seal:

- Hook the clips in the 4 corners onto the seal.

Seal maintenance tips

The seal should be soft and elastic.

- To keep the seal clean, use a non-abrasive sponge and wash with lukewarm water.



Cleaning and maintenance

Replacing the internal light bulb



Live parts

Danger of electrocution

- Unplug the appliance.
- Use protective gloves.

1. Completely remove all accessories from inside the oven.
2. Remove the rack/tray support frames.
3. Use a tool (e.g. a spoon) to remove the bulb cover.



Pay attention not to scratch the oven cavity enamel.

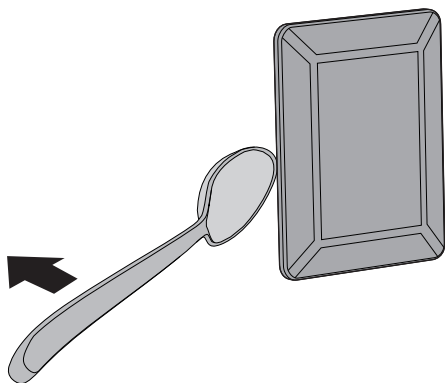

4. Slide out and remove the light bulb.

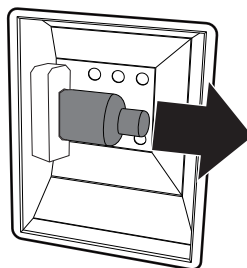

Do not touch the halogen light bulb directly with your fingers, but wrap it in insulating material.

5. Replace the light bulb with one of the same type (40W).
6. Refit the cover. Make sure that the shaped internal part of the glass (**A**) is facing the door.

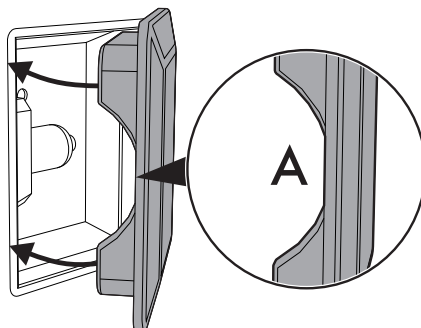

7. Press the cover completely down so that it attaches perfectly to the bulb support.



5 Installation

5.1 Electrical connection



**Power voltage
Danger of electrocution**

- Have the electrical connection performed by authorised technical personnel.
- The appliance must be connected to earth in compliance with electrical system safety standards.
- Disconnect the mains power supply.

General information

Check the grid characteristics against the data indicated on the plate.

The identification plate bearing the technical data, serial number and brand name is visibly positioned on the appliance.

Do not remove this plate for any reason. The appliance operates at 220-240 V~.

Use a three-core cable (3 x 1.5 mm² internal conductors).

Perform the ground connection using a wire that is 20 mm longer than the other wires.

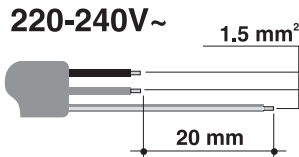

Connection with plug and socket

Make sure that the plug and socket are of the same type.

Avoid using adapters and shunts as these could cause overheating and a risk of burns.

Fixed connection

Fit the power line with an all-pole circuit breaker with a contact separation distance sufficient to provide complete disconnection in category III overvoltage conditions, pursuant to installation regulations.

Testing

At the end of installation, carry out a brief inspection test. If the hob fails to operate, after checking that you have carried out the instructions correctly, unplug the appliance and contact Technical Support.

Cable replacement



**Power voltage
Danger of electrocution**

- Disconnect the mains power supply.

1. Unscrew the rear casing screws and remove the casing to access the terminal board.
2. Replace the cable.
3. Make sure that the cables (for the oven or any hob) follow the best route in order to avoid any contact with the appliance.



Installation

5.2 Positioning



Heavy appliance
Crushing hazard

- Position the appliance into the cabinet cut-out with the help of a second person.



Pressure on the open door
Risk of damage to the appliance

- Never use the oven door to lever the appliance into place when fitting.
- Avoid exerting too much pressure on the oven door when open.



Heat production during appliance operation
Risk of fire

- Check that the carcass material is heat resistant.
- Check that the carcass has the required openings.
- Do not install the appliance in a recess which can be closed with a door, or in a cupboard.

Position of the power cable

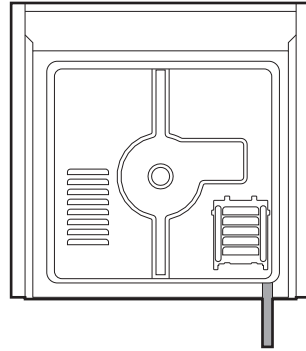

(rear view)

Front panel seal

Glue the supplied seal to the rear part of the front panel to avoid water or other liquids from leaking in.

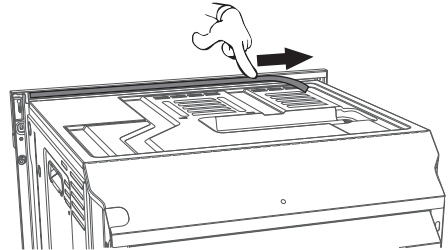



Fastening bushings

1. Remove the bushing covers on the front of the appliance.

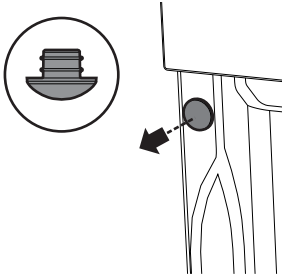

2. Mount the appliance into the recess.
3. Secure the appliance to the carcass using the screws.

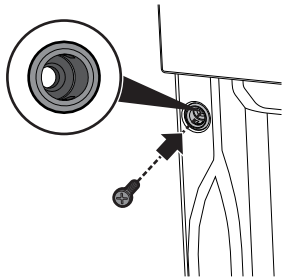

4. Cover the bushings with the previously removed covers.

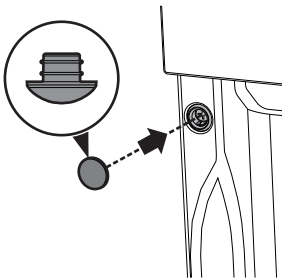

Appliance overall dimensions (mm)

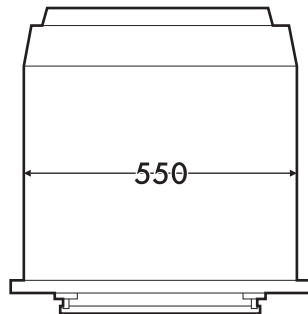
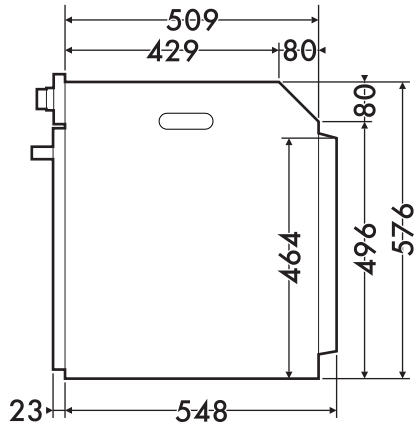
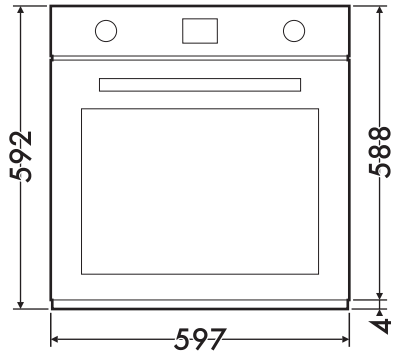

EN



Installation

Mounting under worktops (mm)

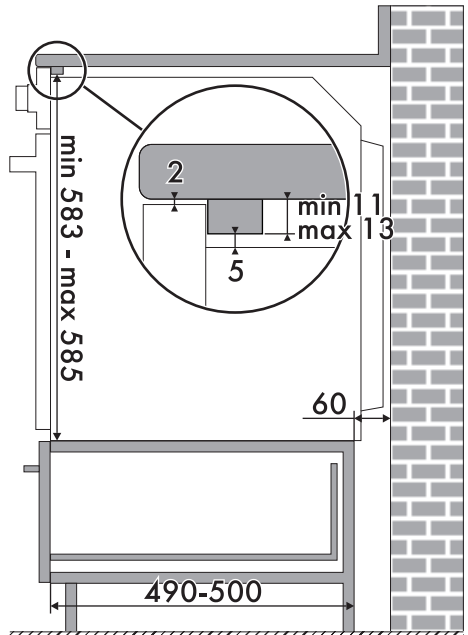
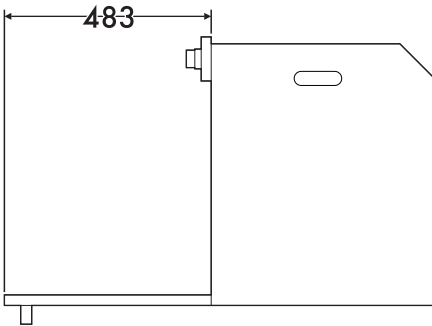
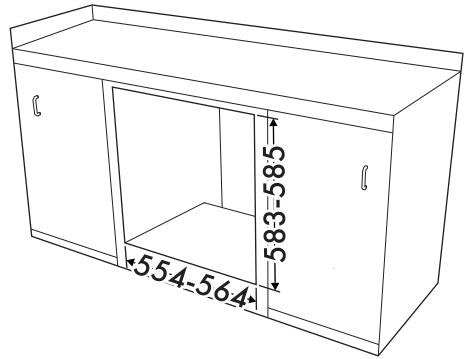
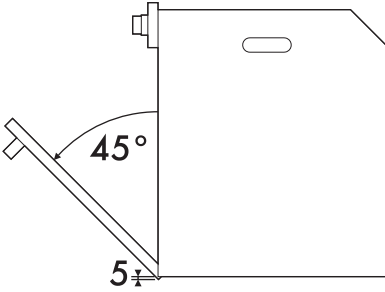

Make sure that there is a space of approx. **60 mm** at the back / bottom of the unit.



Mounting under worktops (pyrolytic models only)

Whenever a hob is installed above the oven, a wooden separator should be installed at a minimum distance of **10 mm** from the top of the oven to prevent overheating when the two appliances are used at the same time. It must only be possible to remove the separator by using suitable tools.

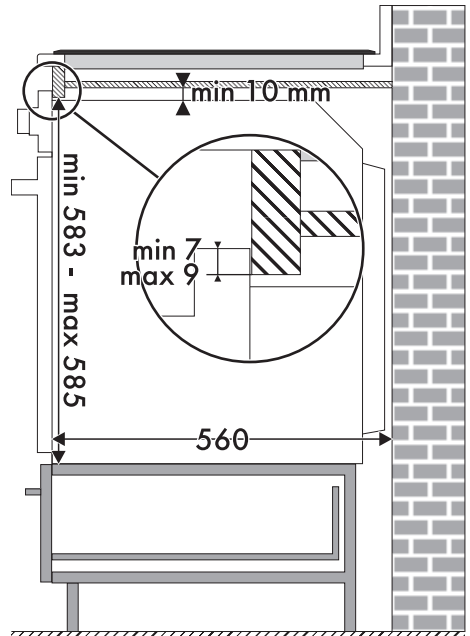
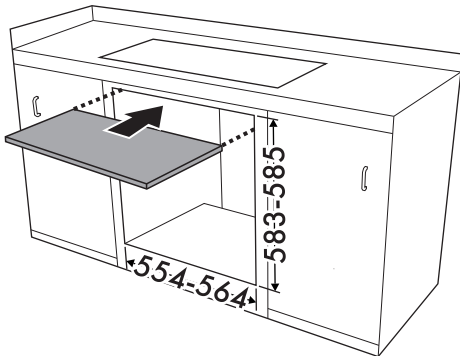

EN



When using a wooden separator, a wooden bar has to be installed under the worktop in order to use the seal that is glued to the back of the front panel to prevent water or other liquids leaking in.



Installation

Mounting into a column (mm)

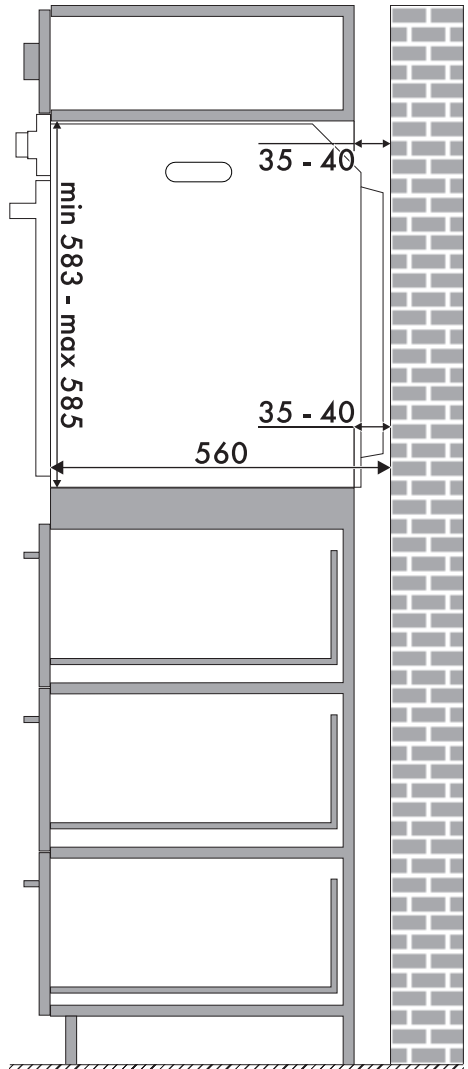
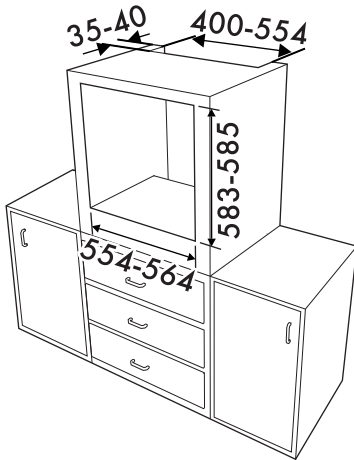

Make sure that there is a space approx. **35-40 mm** deep at the top / back of the unit.