

PRECAUTIONS	23	Preliminary operations	30
General safety instructions	23	Using the hob	31
Installation	26	Safety features	34
Appliance purpose	27	User menu	35
This user manual	27	Error notifications	36
Manufacturer's liability	27	CLEANING AND MAINTENANCE	37
Identification plate	27	Cleaning the glass ceramic hob	37
Disposal	28	What to do if...	37
To save energy	28	INSTALLATION	38
How to read the user manual	28	Electrical connection	38
DESCRIPTION	29	Section cut from the countertop	38
General description	29	Mounting	39
Control panel	29	Ventilation	40
USE	30	Fixing to the built-in cabinet	40
Basic functions	30	Instructions for the installer	40

We advise you to read this manual carefully, which contains all the instructions for maintaining the appliance's aesthetic and functional qualities. For further information on the product: www.smeg.com

PRECAUTIONS

General safety instructions

Risk of personal injury

- During use the appliance and its accessible parts become very hot. Keep children well away from the appliance.
- Protect hands with heat resistant gloves during use.
- Never try to put out a fire or flames with water: Turn off the appliance and smother the flames with a fire blanket or other appropriate cover.
- This appliance may only be used by children aged 8 years and over, and by people of reduced physical, sensory or mental capacity, or lacking in experience in the use of electrical appliances, provided that they are supervised or have been given instructions on the safe use of the appliance and of the hazards associated with it.
- Children must not play with the appliance.
- Keep children under the age of eight at a safe distance unless they are constantly supervised.
- Keep children under the age of 8 away from the appliance when it is in use.
- Cleaning and maintenance must not be carried out by unsupervised children.
- Be aware of how rapidly the cooking zones heat up. Do not place empty pans on the heat. Danger of overheating.
- Activate the controls lock when you have children or pets which

could reach the hob.

- Do not touch or clean the hob surface during operation or when the residual heat indicator lights are still on.
- After use, switch off the plates. Never rely solely on the cookware detector.
- Supervise children carefully as they cannot readily see the residual heat indication. After use the cooking zones remain hot for a certain period of time even if they have been turned off. Keep children away from the cooking zones.
- The cooking process must always be kept under control. A short cooking process must be continuously monitored.
- **WARNING:** Cooking foods containing fat and/or oil without monitoring them can be dangerous and can cause a fire.
- Fats and oils can catch fire if they overheat. Do not leave the appliance unattended while preparing foods containing oils or fats. If fats or oils catch fire, never put water on them. Place the lid on the pan and turn off the relevant cooking zone.
- Do not use the Booster and/or the Double Booster functions (if present) to heat fats or oils. Fire hazard.
- Do not place metal objects, such as dishes or cutlery, on the

surface of the hob during cooking as they may overheat.

- Do not cook foods in closed tins or containers or plastic containers.
- Do not use magnetic tins.
- Do not use trivets or other items between the bottom of the pan and the glass ceramic surface. Danger of burns.
- Do not insert pointed metal objects (cutlery or utensils) into the slots in the appliance.
- Do not use or store flammable materials near the appliance or directly underneath the hob.
- Switch off the appliance immediately after use.
- Do not pull the cable to unplug the appliance (if present).
- **DO NOT USE AEROSOLS IN THE VICINITY OF THIS APPLIANCE WHILST IT IS IN USE.**
- **DO NOT MODIFY THIS APPLIANCE.**
- Always wear personal protective equipment (PPE) before carrying out any work on the appliance (installation, maintenance, positioning or moving).
- Do not clean the appliance if it is still hot or in operation.
- After use the cooking zones remain hot for a certain period of time after they have been turned off. Do not touch the hob surfaces.

- Before performing any work on the appliance, switch off the power supply.
 - Do not try to repair the appliance yourself or without the assistance of a qualified technician.
 - If the power cable becomes damaged, contact technical support immediately to arrange for it to be replaced in order to avoid possible hazards.
 - If cracks or fissures form, or if the glass ceramic cooking surface breaks, turn off the appliance immediately. Disconnect the power supply and call Technical Support.
 - People who have pacemakers or other similar devices fitted must make sure that the operation of these devices is not affected by the induction field, the frequency range of which is between 20 and 50 kHz.
 - In conformity with the provisions regarding electromagnetic compatibility, the electromagnetic induction cooking hob comes under group 2 and class B (EN 55011).
- Risk of damaging the appliance**
- Do not use abrasive or corrosive detergents (e.g. scouring powders, stain removers and metallic sponges) on glass parts.
 - Use wooden or plastic utensils.
 - Do not sit on the appliance.
 - Do not use the glass ceramic cooking surface as a support surface.
 - Do not use the appliance as a support surface.
 - Do not obstruct ventilation openings and heat dispersal slots.
 - Do not use the hob if the pyrolytic cycle is taking place inside any oven installed below.
 - Do not use steam jets to clean the appliance.
 - Never leave the appliance unattended during cooking operations where fats or oils could be released, as these could then heat up and catch fire. Be very careful.
 - Fire hazard: Never leave objects on the cooking surfaces.
 - DO NOT FOR ANY REASON USE THE APPLIANCE AS A SPACE HEATER.
 - Cooking vessels or griddle plates should be placed inside the perimeter of the hob.
 - All pans must have smooth, flat bottoms.
 - If any liquid does boil over or spill, remove the excess from the hob.
 - Take care not to spill acid substances such as lemon juice

- or vinegar on the hob.
- Do not spill sugar or sweet mixtures on the hob during cooking.
 - Do not place materials or substances that could melt or catch fire (paper, plastic or aluminium foil) on the appliance while it is in use.
 - Place the cookware directly on the glass ceramic surface.
 - Do not put empty pans or frying pans on switched on cooking zones.
 - Do not use rough or abrasive materials or sharp metal scrapers.
 - The glass ceramic surface is highly resistant to impact. However, prevent hard, solid objects from falling on the cooking surface as they may cause it to break.
 - Do not use cleaning products containing chlorine, ammonia or bleach on parts made of steel or that have metallic surface finishes (e.g. anodizing, nickel- or chromium-plating).
 - This appliance is not intended to be operated by means of external timer or separate remote control system.

Installation

- **THIS APPLIANCE MUST NOT BE INSTALLED IN BOATS OR CARAVANS.**
- This appliance must not be installed on a dishwasher.
- Position the appliance into the cabinet cut-out with the help of a second person.
- Check that the carcass has the required openings.
- Check that the carcass material is heat resistant.
- Installation and servicing should be carried out by qualified personnel in accordance with current standards.
- Have the electrical connection performed by authorised technical personnel.
- The appliance must be connected to earth in compliance with electrical system safety standards.
- Use cables that can withstand temperatures of at least 90°C.
- Run the power cable in the rear part of the unit. Make sure that it does not come into contact with the lower part of the hob or a built-in oven below it.
- Be careful when connecting additional electrical appliances. Connection cables must not come into contact with hot cooking zones.
- The tightening torque of the screws of the terminal supply wires must be 1.2 - 1.5 Nm.
- Do not attach the appliance too tightly to the unit as this could cause damage during use or partially obstruct the heat dispersal slots.
- The power cable must only be

installed or replaced by a qualified technician.

- If the power cable becomes damaged, contact technical support immediately to arrange for it to be replaced in order to avoid possible hazards.
- Always use any necessary/required personal protective equipment (PPE) before performing any work on the appliance (installation, maintenance, positioning or movement).
- Before performing any work on the appliance, switch off the power supply.
- Allow the appliance to be disconnected after installation, via an accessible plug or a switch in the case of a fixed connection.
- Fit the power line with an all-pole circuit breaker with a contact separation distance sufficient to provide complete disconnection in category III overvoltage conditions, pursuant to installation regulations.
- If the electrical supply is restricted, means of all-pole disconnection must be accessible and incorporated in the fixed wiring in accordance with the wiring rules.
- This appliance can be used up to a maximum altitude of 2,000 metres above sea level.

Appliance purpose

This appliance is intended for cooking food in the home environment. Every other use is considered inappropriate. It cannot be used:

- in employee kitchens, shops, offices and other working environments.
- in farms/farmhouses.
- by guests in hotels, motels and residential environments.
- In bed and breakfast accommodation.

This user manual

- This user manual is an integral part of the appliance and must therefore be kept in its entirety and within the user's reach for the whole working life of the appliance.
- Read this user manual carefully before using the appliance.
- The explanations in this manual include images, which describe all that regularly appears on the display. However, it should be kept in mind that the appliance may be equipped with an updated version of the system, and as such, all that appears on the display may differ from those in the manual.

Manufacturer's liability

The manufacturer declines all liability for damage to persons or property caused by:

- use of the appliance other than that specified;
- failure to comply with the instructions in the user manual;
- tampering with any part of the appliance;
- use of non-original spare parts.

Identification plate

The identification plate bears the technical data, serial number and brand name of the appliance. Do not remove the identification plate for any reason.

Disposal



This appliance conforms to the WEEE European directive (2012/19/EU) and must be disposed of separately from other waste at the end of its service life.

The appliance does not contain substances in quantities sufficient to be considered hazardous to health and the environment, in accordance with current European directives.



Power voltage Danger of electrocution

- Disconnect the mains power supply.
- Unplug the appliance.

To dispose of the appliance:

- Cut the power cable and remove it.
- Deliver the appliance to the appropriate recycling centre for electrical and electronic equipment waste, or return it to the retailer when purchasing an equivalent product, on a one for one basis.

Our appliances are packaged in non-polluting and recyclable materials.

- Deliver the packing materials to the appropriate recycling centre.



Plastic packaging Danger of suffocation

- Do not leave the packaging or any part of it unattended.
- Do not let children play with the plastic bags.

To save energy

- The diameter of the base of the pan must not extend beyond the lines printed on the glass ceramic surface.
- Pans must not be placed outside the perimeter of the hob or on the display.
- When buying a pan, check whether the diameter indicated is that of the base or the top of the pan, as the top is almost always larger than the base.
- When preparing dishes with long cooking times, you can save time and energy by using a pressure cooker, which also helps to retain vitamins contained in the food.
- Make sure that the pressure cooker contains enough liquid as, if there is not enough and it overheats, this may cause damage to both

the pressure cooker and the cooking zone.

- If possible, always cover pans with a suitable lid.
- Choose a pan suitable for the quantity of food to be cooked. A large, half-empty saucepan leads to a waste of energy.



Under certain circumstances, if the hob and the oven are used at the same time, the maximum power limit of the electrical system might be exceeded.

How to read the user manual

This user manual uses the following reading conventions:



Warning/Caution



Information/Advice

DESCRIPTION

General description

EN

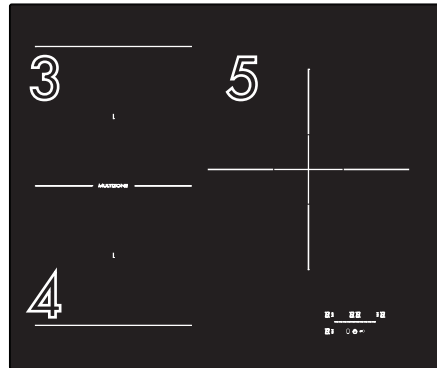
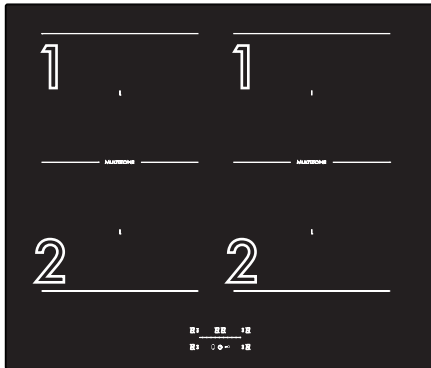

Zone	Dimensions H x L (mm)	Max. power draw (W)*	Power draw in booster function (W) *	Power draw in Double Booster function (W)*
1	220 x 180	2100	2500	3000
2	220 x 180	2100	2500	3000
3	220 x 195	2100	2500	3000
4	220 x 195	2100	2500	3000
5	280 x 280	2800	3600	-
1 + 2 (Multizone)	220 x 360	3000	3700	-
3 + 4 (Multizone)	220 x 390	3000	3700	-

*Power levels are approximate and may vary according to the pan used or the settings made.

Control panel

Cooking zones area

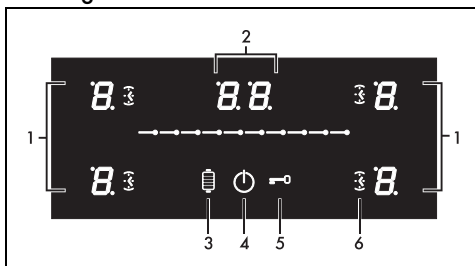

1. Hob zone buttons
2. Set timer button
3. Grill function button
4. ON/OFF button
5. Control lock function button

6. Timer function buttons

Advantages of induction cooking



The appliance is equipped with an induction generator for each cooking zone. Each generator located under the glass ceramic cooking surface creates an electromagnetic field which induces a thermal current in the base of the pan. This means the heat is no longer transmitted from the hob to the pan but created directly inside the pan by the inductive current.

- Energy saving thanks to the direct transmission of energy to the pan (suitable magnetisable cookware is required) compared to traditional electric cooking.
- Improved safety as the energy is only

transmitted to the pan placed on the hob.

- High level of energy transmitted from the induction cooking zone to the base of the pan.

- Rapid heating speed.
- Reduced danger of burns as the cooking surface is only heated under the base of the pan; foods which overflow do not stick.

USE

Basic functions

First power connection

When connected to the power supply for the first time, or after power has been switched back on after a power failure, an automatic check is carried out that control turns on the indicator lights and the displays for a few seconds. Afterwards, the appliance can be used normally.

Preliminary operations



See General safety instructions.

- Remove any protective film from the outside or inside of the appliance, including any accessories (if present).
- Remove any labels (apart from the technical data plate).

Usable cookware diameters

Burner	minimum Ø (cm)	Ø recommended (cm)
Zone 1 - 2 - 3 - 4 (single)	9 - 11*	18
Zone 1 - 2 (Multizone)	19	22
Zone 5	11	28
Zone 3 - 4 (Multizone)	19	22

*If you use pans with a diameter less than the one indicated in the column above, the appliance might not detect them.

Bear in mind the following:

- Do not exceed the limits of the zones printed on the hob.
- Do not cover the control panel.
- Do not place the pans next to the edges of the glass.
- If you wish to use a griddle or a long pan in zones 1 and 2 in Multizone mode, it is recommended that you use one with a maximum size of 22 x 36 cm and a

minimum size of 19 x 19 cm.

Cookware suitable for use in induction cooking

Cookware used on the induction cooking surface must be made of metal, with magnetic properties and a sufficiently large base.

Suitable cookware:

- Enamelled steel cookware with thick bases.
- Cast iron cookware with an enamelled base.
- Cookware in multilayer stainless steel, ferritic stainless steel and aluminium with a special base.

Unsuitable cookware:

- Copper, stainless steel, aluminium, fireproof glass, wood, ceramic and terracotta cookware.

Advice on energy-saving

To see whether the pan is suitable, bring a magnet close to the bottom: if it is attracted, the pan is suitable for induction cooking. If you do not have a magnet, you can put a small amount of water in the pan, place it on a cooking zone and start the hot plate. If the  symbol appears on the display, it means the pan is not suitable.

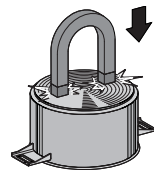

Advice on energy-saving

The diameter of the base of the pan must correspond to the diameter of the cooking zone.

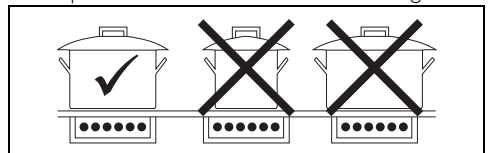

- When buying a pot, check whether the

diameter indicated is that of the base or the top,

as the top is almost always larger than the base.

- The base of the cookware must be thick and completely flat. In addition, the hob should be clean and dry as well.
- When preparing dishes with long cooking times, you can save time and energy by using a pressure cooker, which also makes it possible to preserve the vitamins in the food.
- Make sure that the pressure cooker contains enough liquid as, if there is not enough and it overheats, this may cause damage to both the pressure cooker and the cooking zone.
- If possible, always cover the pans with a suitable lid.
- Choose a pan suitable for the quantity of food to be cooked. A large, half-empty saucepan leads to a waste of energy.
- Do not use cast-iron cookware or cookware with a rough base.



If hob and oven are being used at the same time, under certain conditions the maximum power limit that can be used by your electrical system might be exceeded.

Power level table

The power in the cooking zones can be adjusted to various levels. In the table below you will find instructions for the different types of cooking.

Power level	Suitable for:
0	OFF setting
from 1 to 2	Cooking small amounts of food (minimum power)
from 3 to 4	Cooking
from 5 to 6	Cooking large quantities of food, roasting larger portions
from 7 to 8	Roasting, slow frying with flour
9	Roasting
P/ 	Roasting / browning (maximum power, see Booster and Double Booster)

Switching on and off

To switch on the hob, hold down the **ON/OFF**

 key for 1 second.

If no cooking zone is activated within 25

seconds of switching on, the hob switches off automatically.

Using the hob

Adjusting cooking zones



The appliance is fitted with an automatic pan sensing system.

After switching on the display:

1. Position a pan (suitable for induction cooking and not empty) on the cooking zone you wish to use.
2. The display corresponding to the zone on which the container has been placed turns on automatically and displays .

Adjusting cooking zones

After having placed a pan on the cooking zone and made sure that the zone has been activated:

1. Place a finger on the left-hand side of the scroll bar of the cooking zone to be used.



The power level is now .

2. Move your finger to the left or right to select the power level from 1 to 9 or enable the Booster or Double Booster function (see specific section).

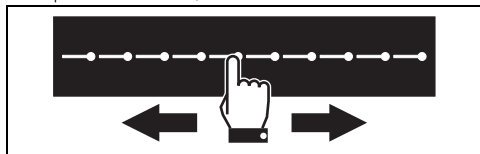

The display of the zone being used will indicate the selected power level.

Intermediate power levels can be set:

1. Press and hold a power level.
2. A dot appears next to the power level on the display of the zone selected.



The power level can also be selected by pressing the scroll bar at the point corresponding to the required power level.

Switching off the cooking zones

1. Move your finger to the far left of the scroll bar of the cooking zone you wish to turn off.

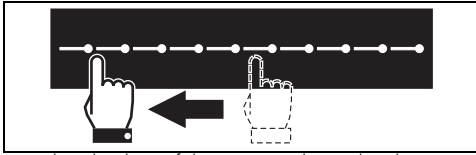

2. The display of the zone selected indicates



Or:

1. Press and hold the zone button for 2 seconds.



To switch off more than one cooking zone at the same time, simply switch off the appliance using the  button.

Booster function

After switching on the hob and having selected a cooking zone:

1. Place a finger on the left-hand side of the scroll bar.



The display of the cooking zone used will turn on: the power level indicated is "1".

2. Slide your finger to the far right on the scroll bar to select power level 9.

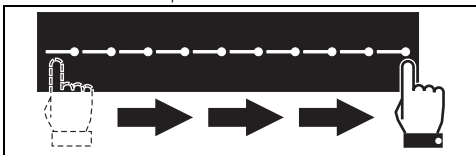

3. Press the segment at the far right of the scroll bar.

The display of the cooking zone used will show "P". Select any other power level to deactivate the Booster function.

The Booster function can be activated quickly:

- Simply press the end of the scroll bar.

To deactivate the function:

- Select any power level on the scroll bar.

- Switching off the appliance.



- The Booster function remains active for a maximum of 5 minutes, after which the power is reduced automatically to level 9.

Double Booster Function

After switching on the hob and having selected a cooking zone, press the last segment at the far right of the scroll bar twice.



The "P" symbol appears on the display of the zone alternating with the  and  symbols.

To deactivate the function:

- Select any power level on the scroll bar.
- Switching off the appliance.

Multizone function



This function automatically divides the power equally between both zones that are in use.



Set this function before selecting a power level

This function allows you to operate two cooking zones (front and rear) at the same time when using pans such as fish kettles or long pans.

To activate the Multizone function:

1. Press the buttons of the left or right cooking zones at the same time.
2. The  symbol appears in the rear zone while the power level appears in the front zone.
3. Slide your finger along the scroll bar to modify the power level.



It is not possible to activate the Booster function for the cooking zones on which the Multizone function is active.

If a large, oval or oblong pan is being used, make sure that it is placed in the centre of the cooking zone.

Controls lock



This feature is designed to lock all the hob controls.

It is always active when the hob is switched on.

It locks all buttons apart from this one and the ON/OFF  button.

This is useful when cleaning the appliance and to prevent functions being modified by mistake.

To activate the controls Lock:

1. Press the  button for at least one second.
2. The LED on the display lights up to indicate that the function has been activated.

To disable the Controls lock, press the  button for at least one second.



When the function is active, pressing any button will cause the controls lock button to flash to indicate that the controls lock function is active.

Warming function

To activate the Warming function, first turn on the hob, then:

1. Select a cooking zone.
2. Press the far left of the scroll bar, approximately between level 0 and level 1, to activate the function; the  symbol appears on the display of the selected cooking zone.

Select any power level to deactivate the Warming function. Or press the  button.



This function allows you to keep cooked food warm or to keep water on the boil.



The warming function deactivates automatically after 2 hours of operation and switches off the cooking zone used.



Recall Function



This is used to restore some functions that have already been started after the appliance has been switched off unintentionally.

If the appliance is switched off unintentionally,

carry out the following procedure within 6 seconds:

1. Switch on the appliance.
 - The  button starts to flash.
2. Press the pause button  immediately to restore the functions that were previously active.



This function restores the cooking zones, timer; no other functions will be restored.

Pause function



This function pauses the operation of all the cooking zones.

To activate the Pause function:

1. Press and hold the timer button for 2 seconds.
2. The  symbols appear.

To deactivate the Pause function:

1. Press and hold the timer button for 2 seconds.





The cooking time limitation, the residual heat indicators and the control lock function remain enabled during the Pause function.

Grill Function

To activate the Grill function:

1. Place a griddle or a long pan on the left zones.
2. Press the  button, which starts to flash.

The  symbol appears on the front zone display and the  symbol appears on the rear zone display. The scroll bar will be set automatically to level 9. (preheating stage).

After three minutes of operation, the power will be reduced to level 7.

The  button remains lit steadily.

Press the  button and use the scroll bar to modify the power level at any time.

Press the  button to deactivate the Grill function.



This function is used to automatically activate the Multizone function for the left zones only. It is used when cooking with a griddle or long pans.

Minute minder timer

After having switched on the hob, without selecting a zone:

1. Touch the inside of the timer setting area.
2. The display shows "0-".
3. The scroll bar can now be used to increase or decrease the value of the right digit. Once set, it flashes for 2 seconds.
4. When it stops flashing ("-5"), you can use the scroll bar to set the left digit (e.g. "15"). Once set, it flashes for 2 seconds and then the function starts.

To deactivate the timer, use the scroll bar to set "00".

To deactivate the function quickly, after having selected the zone, press and hold the timer button for 2 s.



This function is used to set a timer that will emit a sound at the end of the pre-set time.



A maximum time of 99 minutes can be set.

Timed cooking



A maximum of 99 minutes can be set.



This function is used to program the automatic switch-off of each cooking zone at the end of a period of time.



This function can be activated on multiple cooking zones at the same time with different time settings.

The timed cooking function can be activated when at least one cooking zone is switched on:

1. Select a cooking zone.
2. Press the timer setting area.
3. The "0-" symbol appears and the zone LED flashes.
4. The scroll bar can now be used to increase or decrease the value of the right digit. Once set, it flashes for 2 seconds.
5. When it stops flashing ("-5"), you can use the scroll bar to set the left digit (e.g. "15"). Once set, it flashes for 2 seconds. The zone LED stops flashing and the function starts.

Modifying or deactivating timed cooking



To modify or deactivate timed cooking, simply press the timer button of the area selected and

follow the same procedure you used for setting it to modify the minutes or to reset it completely by moving the scroll bar to .

To deactivate the function quickly, after having selected the zone, press and hold the timer button for 2 s.

Residual heat indicator

After the cooking zone has been switched off, a symbol appears on each display to indicate whether the zone is still hot and indicates the approximate temperature:

1.  if the temperature is between 60 °C and 79 °C.
2.  if the temperature is between 80 °C and 99 °C.
3.  if the temperature is 100 °C or higher.



Supervise children carefully as they cannot easily see the residual heat indicator. The cooking zones remain hot for a certain period of time even after they have been turned off. Make sure that children never touch the hob.

Safety features



See General safety instructions.

Limiting the cooking duration

The appliance has an automatic device that limits the duration of use.

If the cooking settings for a pan are not changed, the maximum operation time for each zone depends on the power level selected.

When the device for limiting the duration of use is activated, pan heating is deactivated and

the  symbol appears on the display.





Power level	Maximum cooking duration in hours
1/1.	6
2/2.	6
3/3.	5
4/4.	5
5/5.	4
6/6. - 7/7. - 8/8. - 9/9.	1.5

User menu

The user menu allows you to modify some operating characteristics of the appliance. There are 7 options available. Each option is marked with the letter "U" together with a progressive number on the timer display.

Option	Description
U0	Maximum total power (kW) - To be modified by the installer only
U1	Option disabled
U2	Button volume
U3	Timer alarm volume
U4	Display brightness
U5	Timer animation
U6	Automatic pan detection
U7	Timer alarm duration

Accessing the user menu

1. If the hob is off, switch it on using the  button.
2. Press  again to switch it off; the  button starts to flash.
3. Press and hold .
4. The following symbols appear on the cooking zone displays:

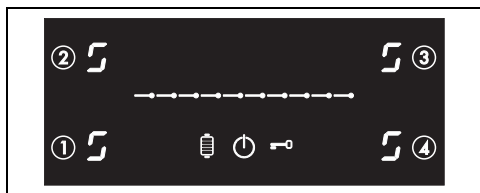

Press all the buttons of the cooking zones in sequence in a clockwise direction starting from the front left:



Press all the buttons of the cooking zones in sequence in a clockwise direction starting from the front left (1). A beep will sound to confirm every effective press of a button.

 If the buttons are pressed in the incorrect order, the procedure for accessing the menu will have to be repeated.

5. Release the  button.

The user menu has been accessed and the  symbol alternating with the number  (option

U0 - Power limitation) appears on the display of the rear left zone.

The total power of the appliance can be modified in steps of 0.1 kW (function Eco-Logic Advance). The timer display indicates the

default power setting (in kW): .

Press the timer display to enable changes to be made to the power settings. Then press the left half of the scroll bar to decrease the power and the right half to increase it. Press and hold the button to reach the required setting more quickly.

- Press the segments of the scroll bar to select an option.



- The first segment on the left (option U0) is reserved for the power limitation procedure (installer only).
- For technical reasons, the second segment from the left (option U1) is disabled. Selecting this option will have no effect.

- After selecting an option, press the front left display to modify it.



According to the adjustment range of each option, the scroll bar will show only those segments that correspond to the adjustments available for each option.

User options

Option U2 modifies the volume of the button sounds; 4 sound levels can be selected using the scroll bar.

- 1: minimum volume.
- 2: medium volume.
- 3: maximum volume. (default value)

Option U3 modifies the volume of the sound signals when the timer has ended. 4 levels can be selected.

- 1: minimum volume.
- 2: medium volume
- 3: maximum level. (default value)

Option U4 modifies the brightness of the display. 10 levels can be selected.

- 0: maximum brightness. (default value)
- 9: minimum brightness.

Option U5 allows you to modify the type of animation of the seconds countdown of the independent timer and timed cooking, from 59

to 0 seconds.



The seconds count is displayed when the timer is set to 1 minute.

- 0: animation off.
- 1: animation on. (default value)

Option U6 allows you to activate or deactivate the automatic pan detection function. (see "Automatic cooking zone activation").

- 0: automatic detection off.
- 1: automatic detection on. (default value)

Option U7 specifies the length of the alarm when the timer has finished. 3 levels can be selected:

- 0: alarm duration 120 seconds. (default value)
- 1: alarm duration 10 seconds.
- 2: alarm disabled.

Exiting the user menu

There are two ways to exit from the user menu:

- 1 Press the  button. Any modifications will be discarded and the hob will be switched off.





Or

- 2 Press the  button for at least two seconds. The modifications will be saved and the hob will be switched off.

Setting the power level of the appliance





- This function allows you to set the maximum power limit for your appliance.
- The induction hob is configured to operate at 7.4 kW, but it can be limited to operate at up to 2.4 kW.

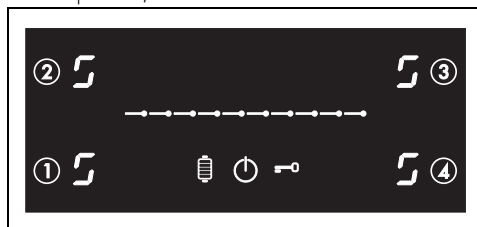

1. Press and hold the  button, press the  button again. The  button starts to flash.
2. Press and hold the  button and press the zone buttons in sequence, as shown in the figure below (for the three-zone model,

leave out the front right zone from the sequence).

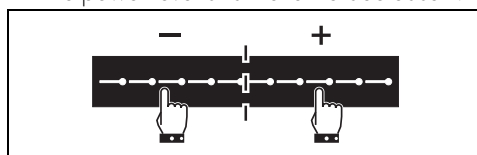

- The  symbol appears alternating with the  symbol.
 - The set power level is shown in the timer setting area.
3. Press the set Timer button, located above the scroll bar, to modify the value.
 4. Press the right of the scroll bar to increase the power level and the left to decrease it.



5. Press the  button to save the new setting; or press and hold the  button.
- Press the  button to exit without saving the setting.

Error notifications

If the appliance malfunctions or operates incorrectly, the associated error code appears on the display.

The error codes always begin with the letter "E" or "Er" followed by a series of digits (e.g. "Er47-30").

Errors coded as:

- "E02"
- "E2"
- "Er21"

Indicate that the appliance or part of it is overheating. If this occurs, you should switch off the appliance immediately, remove all pans and let it cool down.

If these errors persist or if other errors appear, make a note of the code and contact Technical Support.

CLEANING AND MAINTENANCE

Cleaning the glass ceramic hob



See General safety instructions.

Cleaning the surfaces

To keep the surfaces in good condition, they should be cleaned regularly after use. Let them cool first.

Ordinary daily cleaning

Always and only use specific products that do not contain abrasives or chlorine-based acids. Pour the product onto a damp cloth and wipe the surface, rinse thoroughly and dry with a soft cloth or a microfibre cloth.



In case of stubborn dirt, clean when cold using a damp kitchen sponge and neutral detergent; then dry with a microfibre cloth.

Weekly cleaning

Clean and maintain the hob once a week using an ordinary glass ceramic cleaning product. Always follow the manufacturer's instructions. The silicon in these products creates a protective, water-repellent membrane which also resists dirt. All marks stay on the membrane and can therefore be removed easily. After cleaning, dry the surface with a clean cloth. Make sure that there is no detergent left on the cooking surface as it might undergo an aggressive reaction when heated up and could modify the structure of the cooking surface.

Food stains or residues

Light coloured marks from pans with aluminium bases can be easily cleaned off with a cloth moistened in vinegar. Remove any burnt-on residues after cooking; then rinse with water and dry thoroughly with a clean cloth. Dirt, which may have fallen on the hob while cleaning lettuce or potatoes, can scratch the hob when moving pans. Consequently, remove any dirt from the cooking surface immediately. Changes in colour do not affect the operation and stability of the glass. These are not alterations to the material of the hob but just residues which have not been removed and have then carbonised. Shiny surfaces can form due to the bases of pans, especially aluminium ones, rubbing on the surface, and due to the use of

unsuitable detergents. They are difficult to remove using conventional cleaning products. It may be necessary to repeat the cleaning process several times. Use of corrosive detergents or rubbing of pan bases can wear away the decoration on the hob over time and contribute to the formation of stains.



We recommend the use of cleaning products distributed by the manufacturer.



After cleaning, dry the appliance thoroughly to prevent any water or detergent from interfering with its operation or creating unsightly marks.

What to do if...

The hob does not work:

- Make sure that the hob is connected and that the main switch is turned on.
- Make sure that there is no power failure.
- Make sure that the fuse has not blown. In this case replace the fuse.
- Make sure that the circuit breaker of the residential electrical system has not tripped. In this case, reset the circuit breaker.

The cooking results are unsatisfactory:

- Make sure that the cooking temperature is not too high or too low.
- Make sure that the hob is properly ventilated and that the air inlets are unobstructed.
- Use cookware that is certified and tested for induction cooking.

The hob smokes:

- Let the hob cool down and clean it once cooking is complete.
- Make sure that the food has not spilled out of the pan and use a larger cooking vessel, if needed.

The fuses blow or the circuit breaker of the residential electrical system trips repeatedly.

- Call Technical Support or an electrician.

There are cracks or fissures in the hob:

- Turn off the appliance immediately, disconnect the power supply and contact Technical Support.

INSTALLATION

Electrical connection



See General safety instructions.

General information

Check the mains characteristics against the data indicated on the plate.

The identification plate bearing the technical data, serial number and brand name is visibly positioned on the appliance.

Do not remove this plate for any reason.

The appliance must be connected to ground using a wire that is at least 20 mm longer than the other wires.

The appliance can be connected as follows:

- 220-240 / 380-415 V 2N~

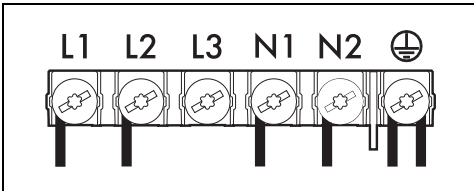

Six-core cable 6 x 1.5 mm².

- 220-240V 1N

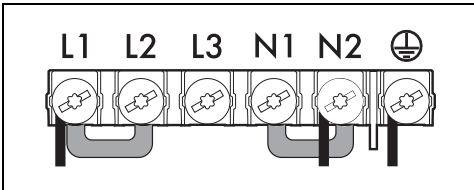

Three-core cable 3 x 6 mm².

Fixed connection

Fit the power line with an all-pole circuit breaker with a contact separation distance sufficient to provide complete disconnection in category III overvoltage conditions, pursuant to installation regulations.

For the Australian/New Zealand market:

The circuit breaker incorporated in the fixed connection must comply with AS/NZS 3000.

Section cut from the countertop

Safety instructions for positioning and installation



See General safety instructions.

- Installation can be carried out on various materials such as masonry, metal, solid wood or plastic laminated wood as long as they are heat resistant (>90°C).
- Veneers, adhesives or plastic coatings on adjacent furniture should be temperature-resistant (>90°C), otherwise they might warp over time.
- If the piece of furniture does not have the required recess opening, either it will have to be cut or masonry work carried out by a competent technician.
- The minimum clearance between exhaust hoods and the cooking surface must be at least the distance indicated in the exhaust hood installation instructions.
- The minimum clearances must also be respected for the edges of the hob on the back as indicated in the assembly instructions.
- If the appliance is to be installed above an oven, the oven must be fitted with a cooling fan.

Appliance overall dimensions (mm)

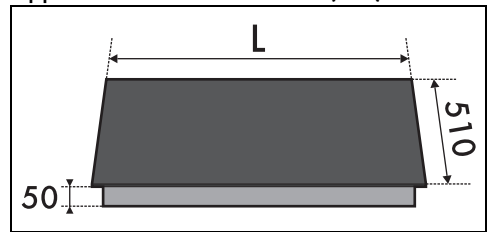

MODELS (cm)	L
60	600
70	750

Standard and flush mounting (mm)

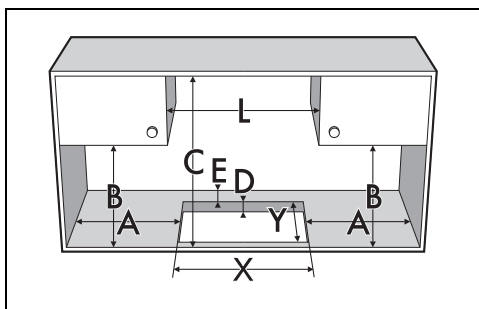

A	B	C	D	E
min 150	min 460	min 750	20 - 60	min 50

L	X	Y	G	H
600-750	560	490/ 478÷482	604	514

Flush mounting

For this type of mounting, you have to make an additional cut at the edges of the recess in the furniture if you wish to install the hob flush with the countertop.

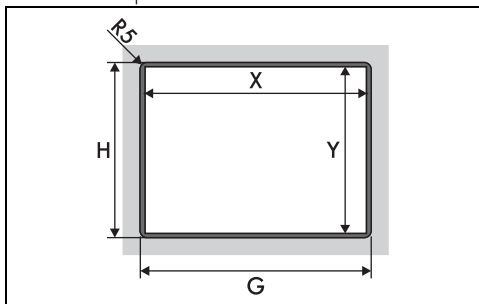

*Refer to the measurements in the table above.

Hob seal

To prevent leakage of liquid between the frame of the hob and the countertop, place the adhesive seal provided along the entire outer edge of the hob before assembly.

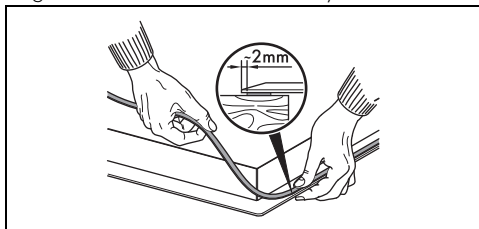

Do not use silicone to secure the hob. This would make it impossible to remove the hob without damaging it.

In the case of flush mounting, after placing the adhesive seal (A) on the glass surface and after positioning and securing the hob, fill the edges with insulating silicone (B) and wipe off any excess. If for any reason the hob needs to be removed, cut the silicone using a cutter before attempting to remove it (C).

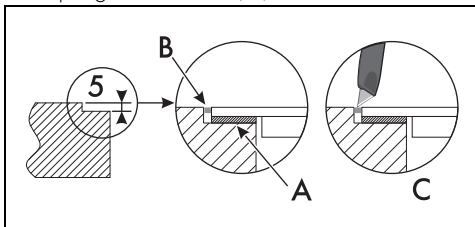

Mounting

On top of oven built-in unit

The clearance between the hob and the kitchen furniture or other installed appliances must be enough to ensure sufficient ventilation and air discharge. If installed above an oven, a space must be left between the bottom of the hob and the top of the appliance installed below.

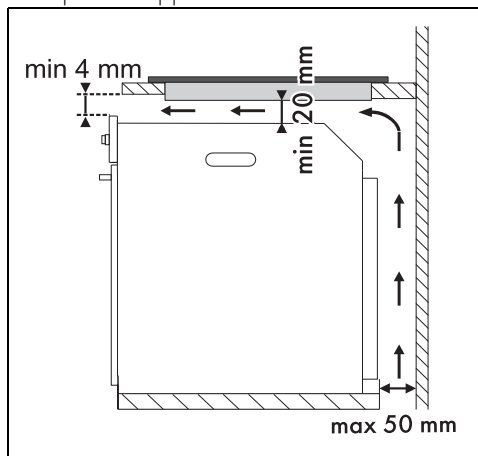

On top of empty kitchen unit or drawers

If there are other pieces of furniture (lateral walls, drawers, etc.), dishwashers or fridges under the hob, a double-layer wooden base must be installed at least 20 mm from the bottom of the hob to avoid any accidental contact. It must

only be possible to remove the double-layer base using suitable equipment.

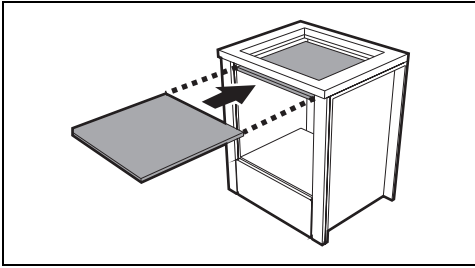

opens on bottom:

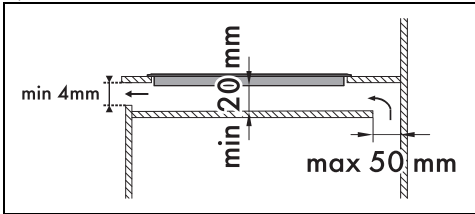

opens on rear:

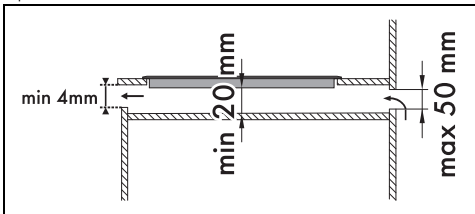

Failure to install the double-layer wooden base exposes the user to possible accidental contact with sharp or hot parts.



If installed on top of an oven, the latter must be equipped with a cooling fan.

Ventilation

The illustrations below show two examples of installation suitable for proper ventilation and one example of incorrect installation to be

avoided.

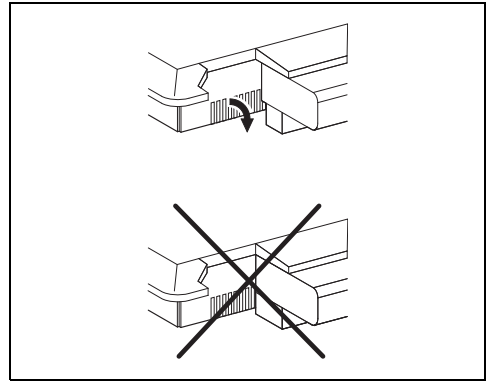

Fixing to the built-in cabinet



The clips should not be installed at the front of the appliance.

To ensure the hob is fixed and centred as accurately as possible, the clips provided must be positioned as described below:

1. Fit the clips by gently pressing them horizontally into the appropriate space.
2. Then turn them upwards to fix them in place.

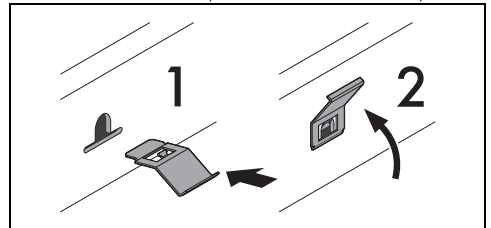

Instructions for the installer

- If you use a plug (if present) to connect to the power supply, the plug must be accessible after installation.
- Do not bend or trap the power cable.
- The appliance must be installed according to the installation diagrams.
- If the appliance does not work correctly after having carried out all the checks, contact your local Authorised Service Centre.
- Once the appliance has been installed, please explain to the user how to use it correctly.