

Panasonic®

OPERATING INSTRUCTIONS

TX-43LX650B / TX-43LX650BZ / TX-43LX660B

TX-50LX650B / TX-50LX650BZ / TX-50LX660B

TX-55LX650B / TX-55LX650BZ / TX-55LX660B

TX-65LX650B / TX-65LX650BZ / TX-65LX660B

LED TV



e-MANUAL

You can find instructions for your TV's features in the **E-Manual**. To access the **E-Manual**, enter **Settings** menu, select **Manuals** and press **OK**. For quick access press **Home/Menu** button and then **Info** button.

Table of Contents

Safety Information	2	Video	31
IMPORTANT - Please read these instructions fully before installing or operating.....	2	Audio	32
Markings on the Product	2	Picture	34
Maintenance.....	4	Subtitle.....	34
Display panel, Cabinet, Pedestal	4	Supported DVI Resolutions.....	35
Mains plug.....	4	Specification.....	36
Assembling / Removing the pedestal.....	4	Notice.....	37
When using the wall-hanging bracket	5	Licences.....	38
Introduction	6	Disposal of Old Equipment and Batteries	38
Accessories Included	6	Declaration of Conformity (DoC).....	38
Features	6	Sales and Support Information.....	39
Antenna Connection.....	7	Important Instruction	40
Other Connections	8		
Turning On/Off the TV	9		
TV Control & Operation.....	9		
Remote Control	10		
Initial Setup Wizard	11		
Home Screen	14		
Live TV Mode Menu Content	14		
Channels	14		
TV Options.....	14		
Settings	16		
Network & Internet.....	16		
Channel	16		
Accounts & Sign In	19		
Apps	19		
Device Preferences	19		
Remote & Accessories	23		
Channel List	23		
Programme Guide.....	24		
Connecting to the Internet.....	24		
Multi Media Player.....	25		
From USB Connection.....	27		
CEC.....	27		
Google Cast	28		
HBBTV System	29		
Freeview Play Platform	29		
Quick Standby Search	29		
Software Update	29		
Troubleshooting & Tips	30		
HDMI Signal Compatibility	30		
Supported File Formats for USB Mode.....	31		

Safety Information

	CAUTION RISK OF ELECTRIC SHOCK DO NOT OPEN	
	CAUTION: TO REDUCE THE RISK OF ELECTRIC SHOCK DO NOT REMOVE COVER (OR BACK). NO USER-SERVICEABLE PARTS INSIDE. REFER SERVICING TO QUALIFIED SERVICE PERSONNEL.	

In extreme weather (storms, lightning) and long inactivity periods (going on holiday) disconnect the TV set from the mains.

The mains plug is used to disconnect TV set from the mains and therefore it must remain readily operable. If the TV set is not disconnected electrically from the mains, the device will still draw power for all situations even if the TV is in standby mode or switched off.

Note: Follow the on screen instructions for operating the related features.

IMPORTANT - Please read these instructions fully before installing or operating

 **WARNING:** This device is intended to be used by persons (including children) who are capable / experienced of operating such a device unsupervised, unless they have been given supervision or instruction concerning the use of the device by a person responsible for their safety.



- Use this TV set at an altitude of less than 5000 metres above the sea level, in dry locations and in regions with moderate or tropical climates.
- The TV set is intended for household and similar indoor use but may also be used in public places.
- For ventilation purposes, leave at least 5cm of free space around the TV.
- The ventilation should not be impeded by covering or blocking the ventilation openings with items, such as newspapers, table-cloths, curtains, etc.
- The power cord/plug should be easily accessible. Do not place the TV, furniture, etc. on the power cord. A damaged power cord/plug can cause fire or give you an electric shock. Handle the power cord by the plug, do not unplug the TV by pulling the power cord. Never touch the power cord/plug with wet hands as this could cause a short circuit or electric shock. Never make a knot in the power cord or tie it with other cords. When damaged it must be replaced, this should only be done by qualified personnel.
- Do not expose the TV to dripping or splashing of liquids and do not place objects filled with liquids, such as vases, cups, etc. on or over the TV (e.g. on shelves above the TV).

- Do not expose the TV to direct sunlight or do not place open flames such as lit candles on the top of or near the TV. 
- Do not place any heat sources such as electric heaters, radiators, etc. near the TV set.
- Do not place the TV on the floor or inclined surfaces.
- To avoid danger of suffocation, keep plastic bags out of the reach of babies, children and domestic animals.
- Carefully attach the stand to the TV. If the stand is provided with screws, tighten the screws firmly to prevent the TV from tilting. Do not over-tighten the screws and mount the stand rubbers properly.
- Do not dispose of the batteries in fire or with hazardous or flammable materials.

WARNING

- Batteries must not be exposed to excessive heat such as sunshine, fire or the like.
- Excessive sound pressure from earphones or headphones can cause hearing loss.

ABOVE ALL - NEVER let anyone, especially children, push or hit the screen, push anything into holes, slots or any other openings in the TV.

 Caution	Serious injury or death risk
 Risk of electric shock	Dangerous voltage risk
 Maintenance	Important maintenance component

Mains Supply

The set should be operated only from a 220-240 V AC 50 Hz outlet. Make sure the TV or its stand are not placed on the power cord. DO NOT cut off the mains plug from this equipment, this incorporates a special Radio Interference Filter, the removal of which will impair its performance. In the UK, the fuse fitted in this plug is approved by ASTA or BSI to BS1362. It should only be replaced by a correctly rated and approved type. IF IN DOUBT PLEASE CONSULT A COMPETENT ELECTRICIAN.

Markings on the Product

The following symbols are used on the product as a marker for restrictions and precautions and safety instructions. Each explanation shall be considered where the product bears related marking only. Note such information for security reasons.



Class II Equipment: This appliance is designed in such a way that it does not require a safety connection to electrical earth.



Hazardous Live Terminal: The marked terminal(s) is/are hazardous live under normal operating conditions.



Caution, See Operating Instructions: The marked area(s) contain(s) user replaceable coin or button cell batteries.



Class 1 Laser Product: This product contains Class 1 laser source that is safe under reasonably foreseeable conditions of operation.

WARNING

Do not ingest the battery, Chemical Burn Hazard
This product or the accessories supplied with the product may contain a coin/button cell battery. If the coin/button cell battery is swallowed, it can cause severe internal burns in just 2 hours and can lead to death. Keep new and used batteries away from children. If the battery compartment does not close securely, stop using the product and keep it away from children. If you think batteries might have been swallowed or placed inside any part of the body, seek immediate medical attention.

Warning Stability Hazard

A television may fall, causing serious personal injury or death. Many injuries, particularly to children, can be avoided by taking simple precautions such as:

- ALWAYS use cabinets or stands or mounting methods recommended by the manufacturer of the television set.
- ALWAYS use furniture that can safely support the television set.
- ALWAYS ensure the television set is not overhanging the edge of the supporting furniture.
- ALWAYS educate children about the dangers of climbing on furniture to reach the television set or its controls.
- ALWAYS route cords and cables connected to your television so they cannot be tripped over, pulled or grabbed.
- NEVER place a television set in an unstable location.
- NEVER place the television set on tall furniture (for example, cupboards or bookcases) without anchoring both the furniture and the television set to a suitable support.
- NEVER place the television set on cloth or other materials that may be located between the television set and supporting furniture.
- NEVER place items that might tempt children to climb, such as toys and remote controls, on the top of the television or furniture on which the television is placed.
- The equipment is only suitable for mounting at heights ≤2 m.

If the existing television set is going to be retained and relocated, the same considerations as above should be applied.

Apparatus connected to the protective earthing of the building installation through the MAINS connection or through other apparatus with a connection to protective earthing – and to a television distribution system using coaxial cable, may in some circumstances create a fire hazard. Connection to a television distribution system has therefore to be provided through a device providing electrical isolation below a certain frequency range (galvanic isolator).

WALL MOUNTING WARNINGS

- Read the instructions before mounting your TV on the wall.
- The wall mount kit is optional. You can obtain from your local dealer, if not supplied with your TV.
- Do not install the TV on a ceiling or on an inclined wall.
- Use the specified wall mounting screws and other accessories.
- Tighten the wall mounting screws firmly to prevent the TV from falling. Do not over-tighten the screws.

Using the special functions to change the size of the displayed image (i.e. changing the height/width ratio) for the purposes of public display or commercial gain may infringe on copyright laws.

The LCD display panels are manufactured using an extremely high level of precision technology; however, sometimes some parts of the screen may be missing picture elements or have luminous spots. This is not a sign of a malfunction.

WARNING

- Using other wall-hanging brackets, or installing a wall-hanging bracket by yourself have the risk of personal injury and product damage. In order to maintain the unit's performance and safety, be absolutely sure to ask your dealer or a licensed contractor to secure the wall-hanging brackets. Any damage caused by installing without a qualified installer will void your warranty.
- Carefully read the instructions accompanying optional accessories, and be absolutely sure to take steps to prevent the TV from falling off.
- Handle the TV carefully during installation since subjecting it to impact or other forces may cause product damage.
- Take care when fixing wall brackets to the wall. Always ensure that there are no electrical cables or pipes in the wall before hanging bracket.
- To prevent fall and injury, remove the TV from its fixed wall position when it is no longer in use.

Figures and illustrations in these operating instructions are provided for reference only and may differ from the actual product appearance. Product design and specifications may be changed without notice.

Maintenance

First, remove the mains plug from the mains socket.

Display panel, Cabinet, Pedestal

Regular care:

Gently wipe the surface of the display panel, cabinet, or pedestal by using a soft cloth to remove dirt or fingerprints.

For stubborn dirt:

1. First clean the dust from the surface.
2. Dampen a soft cloth with clean water or diluted neutral detergent (1 part detergent to 100 parts water).
3. Wring out the cloth firmly. (Please note, do not let liquid enter the TV inside as it may lead to product failure.)
4. Carefully wipe moisten and wipe away the stubborn dirt.
5. Finally, wipe away all the moisture.

Caution

Do not use a hard cloth or rub the surface too hard, otherwise this may cause scratches on the surface.

- Take care not to subject the surfaces to insect repellent, solvent, thinner or other volatile substances. This may degrade surface quality or cause peeling of the paint.
- The surface of the display panel is specially treated and may be easily damaged. Take care not to tap or scratch the surface with your fingernail or other hard objects.
- Do not allow the cabinet and pedestal to make contact with a rubber or PVC substance for a long time. This may degrade surface quality.

Mains plug

Wipe the mains plug with a dry cloth at regular intervals.

Moisture and dust may cause fire or electrical shock.

Assembling / Removing the pedestal

Preparations

Take out the pedestal(s) and the TV from the packing case and put the TV onto a work table with the screen panel down on the clean and soft cloth (blanket, etc.)

- Use a flat and firm table bigger than the TV.
- Do not hold the screen panel part.
- Make sure not to scratch or break the TV.

CAUTION: Please refrain from inserting pictured screws to the TV body when not using the TV stand e.g. wall hanging. Inserting screws without pedestal may cause a damage of the TV.

Assembling the pedestal

1. The stand of the TV consists of 4 pieces. Install these pieces together.

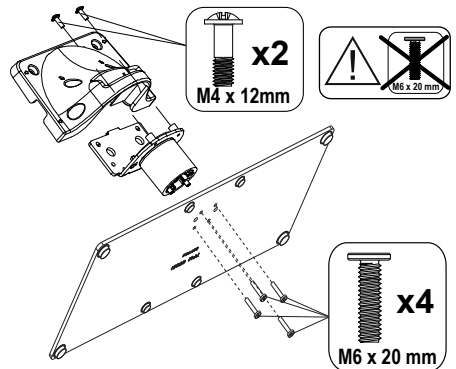

2. Place the stand(s) on the stand mounting pattern(s) on the rear side of the TV.

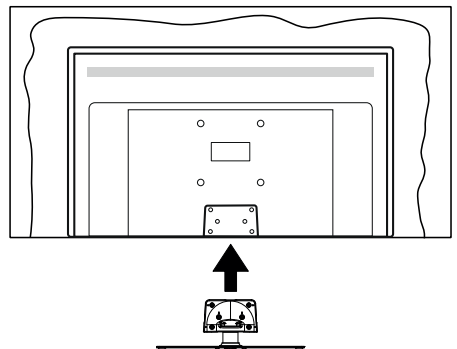

3. Insert the screws (M4 x 12) provided and tighten them gently until the stand is properly fitted.

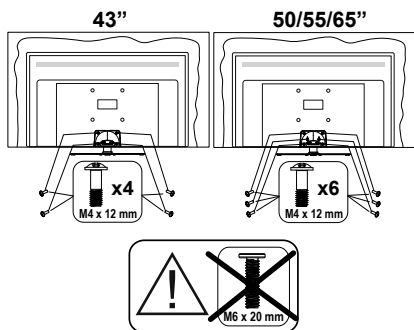

Removing the pedestal from the TV

Be sure to remove the pedestal in the following way when using the wall-hanging bracket or repacking the TV.

- Put the TV onto a work table with the screen panel down on the clean and soft cloth. Leave the stand(s) protruding over the edge of the surface.
- Unscrew the screws that fixing the stand(s).
- Remove the stand(s).

When using the wall-hanging bracket

Please contact your local Panasonic dealer to purchase the recommended wall-hanging bracket.

Holes for wall-hanging bracket installation;

Rear of the TV

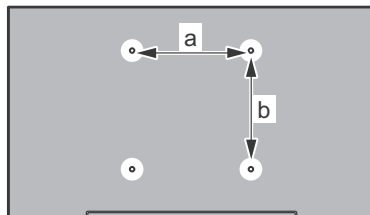

	43"	50"	55"	65"
a (mm)	100	200	200	400
b (mm)	100	200	200	200

View from the side

VESA Bracket

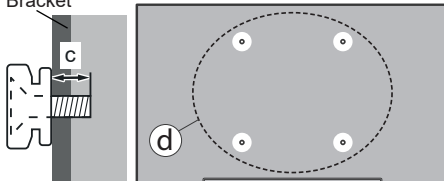

		43"	50", 55", 65"
(d)	Depth of screw (c)	min.	9 mm
		max.	10 mm
Diameter		M4	M6

Note: The screws for fixing the TV onto the wall-hanging bracket are not supplied with the TV.

Introduction

Thank you for choosing our product. You'll soon be enjoying your new TV. Please read these instructions carefully. They contain important information which will help you get the best from your TV and ensure safe and correct installation and operation.

Accessories Included

- Remote Control
- Batteries: 2 x AAA
- Operating Instructions
- Detachable stand
- Stand mounting screws (M4 x 12)

Features

- Remote controlled colour TV
- Android™ operating system
- Google Cast
- Voice Search (optional)
- Fully integrated digital terrestrial/cable/satellite TV (DVB-T-T2/C/S-S2)
- HDMI inputs to connect other devices with HDMI sockets
- USB input
- Stereo sound system
- Teletext
- Headphone connection
- Automatic programming system
- Manual tuning
- Sleep timer
- On/Off timer
- Switch off timer
- Picture off function
- No signal auto power off function
- Ethernet (LAN) for Internet connectivity and service
- 802.11 a/b/g/n/ac built in WLAN Support
- HbbTV

Ultra HD (UHD)

The TV supports Ultra HD (Ultra High Definition - also known as 4K) which provides resolution of 3840 x 2160 (4K:2K). It equals 4 times the resolution of Full HD TV by doubling the pixel count of the Full HD TV both horizontally and vertically. Ultra HD content is supported via native and market applications, HDMI, some of the Over-the-Top (OTT) services, USB inputs and over DVB-T2 and DVB-S2 broadcasts.

High Dynamic Range (HDR) / Hybrid Log-Gamma (HLG)

Using this feature the TV can reproduce greater dynamic range of luminosity by capturing and then combining several different exposures. HDR/HLG promises better picture quality thanks to brighter, more realistic highlights, more realistic colour and other improvements. It delivers the look that filmmakers intended to achieve, showing the hidden areas of dark shadows and sunlight with full clarity, colour and detail. HDR/HLG content is supported via native and market applications, HDMI, USB inputs and over DVB-S broadcasts. When the input source is set to the related HDMI input press the **Menu** button and set the **HDMI EDID Version** option in the **TV Options>Settings>Device Preferences>Inputs** menu as **EDID 2.0** or **Auto EDID** in order to watch HDR/HLG content, if the HDR/HLG content is received through an HDMI input. The source device should also be at least HDMI 2.0a compatible in this case.

Dolby Vision

Dolby Vision™ delivers a dramatic visual experience, astonishing brightness, exceptional contrast, and vivid colour, that brings entertainment to life. It achieves this stunning image quality by combining HDR and wide colour gamut imaging technologies. By increasing the brightness of the original signal and using a higher dynamic colour and contrast range, Dolby Vision presents amazing true-to-life images with stunning detail that other post-processing technologies in the TV aren't able to produce. Dolby Vision is supported via native and market applications, HDMI and USB inputs. When the input source is set to the related HDMI input press the **Menu** button and set the **HDMI EDID Version** option in the **TV Options>Settings>Device Preferences>Inputs** menu as **EDID 2.0** or **Auto EDID** in order to watch Dolby Vision content, if the Dolby Vision content is received through an HDMI input. The source device should also be at least HDMI 2.0a compatible in this case. In the **Picture Mode** menu three predefined picture modes will be available if Dolby Vision content is detected: **Dolby Vision Bright**, **Dolby Vision Dark** and **Dolby Vision Vivid**. All allow the user to experience the content in the way the creator originally intended with different ambient lighting conditions. To change the **Picture Mode** setting press the **Menu** button while watching the Dolby Vision content and go to **Picture** menu. While watching Dolby Vision Content via an application, except YouTube, Netflix and Multi Media Player, you will not be able to access the **Picture** menu and set the **Picture Mode**.

Antenna Connection

Connect the aerial or cable TV plug to the AERIAL INPUT (ANT) socket located on the left side of the TV or satellite plug to the SATELLITE INPUT (LNB) socket located on the rear side of the TV.

Left side of the TV

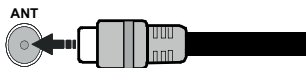

Rear side of the TV

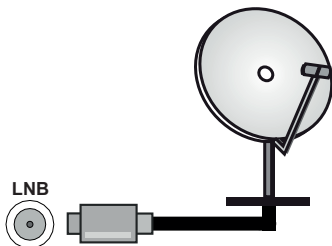











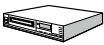







If you want to connect a device to the TV, make sure that both the TV and the device are turned off before making any connection. After the connection is done, you can turn on the units and use them.

Other Connections



If you want to connect a device to the TV, make sure that both the TV and the device are turned off before making any connection. After the connection is done, you can turn on the units and use them.

Connector	Type	Cables	Device
	HDMI Connection (back&side)		
	SPDIF (Optical Out) Connection (back)		
	Headphone Connection (back)		
	USB Connection (side)		
	CI Connection (side)		
	Ethernet Connection (back)	 LAN / Ethernet Cable	

When using the wall mounting kit (contact your dealer to purchase one, if not supplied), we recommend that you plug all your cables into the back of the TV before mounting on the wall. Insert or remove the CI module only when the TV is SWITCHED OFF. You should refer to the module instruction manual for details of the settings. The USB inputs on the TV support devices up to 500mA. Connecting devices that have current value above 500mA may damage your TV. When connecting equipment using a HDMI cable to your TV, to guarantee sufficient immunity against parasitic frequency radiation and trouble-free transmission of high definition signals, such as 4K content, you have to use a high speed shielded (high grade) HDMI cable with ferrites.

Turning On/Off the TV

Connect power

IMPORTANT: The TV set is designed to operate on 220-240V AC, 50 Hz socket.

After unpacking, allow the TV set to reach the ambient room temperature before you connect the set to the mains.

Plug the power cord to the mains socket outlet. The TV will switch on automatically.

To switch on the TV from standby

If the TV is in standby mode the standby LED lights up. To switch on the TV from standby mode either:

- Press the **Standby** button on the remote control.
- Press the centre of the joystick on the TV in.

To switch the TV into standby

The TV cannot be switched into standby mode via joystick. Press and hold the **Standby** button on the remote control. **Power off** dialogue will appear on the screen. Highlight **OK** and press the **OK** button. The TV will switch into standby mode.

To switch off the TV

To power down the TV completely, unplug the power cord from the mains socket.

Quick standby mode

In order to switch the TV into quick standby mode either;

- Press the **Standby** button on the remote. Press again to go back to operating mode.
- Press and hold the centre of the joystick on the TV. Press again to go back to operating mode.

Your TV continues to operate in the quick standby mode state, as it regularly checks for updates. This is not a malfunction, it meets the requirements for energy consumption. In order to minimise energy consumption switch your TV into standby mode as explained above.

Note: When the TV is switched into standby mode, the standby LED can blink to indicate that features such as standby search or timer is active. The LED can also blink when you switch on the TV from standby mode.

TV Control & Operation

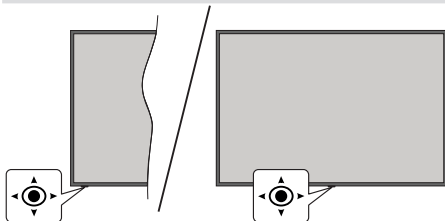

The joystick allows you to control the Volume / Programme / Source and Quick Standby-On functions of the TV.

Note: The position of the joystick may differ depending on the model.

To change volume: With the front side of the TV facing you, push the joystick right to increase the volume and push it left to decrease the volume.

To change channel in Live TV mode: Scroll through the stored channels by pushing the joystick forwards or pulling it towards yourself.

To change source in Live TV mode: Press the centre of the joystick in, the **TV options** menu will be displayed. Highlight **Source** option and press the centre of the joystick in again, the **Inputs** list will appear on the screen. Select the desired source by pushing the joystick forwards or pulling it towards yourself and press the centre of the joystick in.

To turn the TV off (Quick Standby): Press the centre of the joystick in and hold it down for a few seconds, the TV will turn into quick standby mode.

To turn the TV off (Standby): The TV cannot be switched into standby mode via joystick.

To turn on the TV: Press the centre of the joystick in, the TV will turn on.

Operation with the Remote Control

Press the **Menu** button on your remote control to display Live TV settings menu when in Live TV mode. Press **Home** button to display or return to the Home Screen of the Android TV. Use the directional buttons to move the focus, proceed, adjust some settings and press **OK** to make selections in order to make changes, set your preferences, enter a sub-menu, launch an application, etc. Press **Back/Return** to return to the previous menu screen.

Input Selection

Once you have connected external systems to your TV, you can switch to different input sources. Press the **Source** button on your remote control consecutively or use the directional buttons and then press the **OK** button to switch to different sources when in Live TV mode. Or enter the **Inputs** menu on the Home Screen, select the desired source from the list and press **OK**.

Changing Channels and Volume

You can adjust the volume by using the **Volume +/-** buttons and change the channel in Live TV mode by using the **Programme +/-** buttons on the remote.

Remote Control

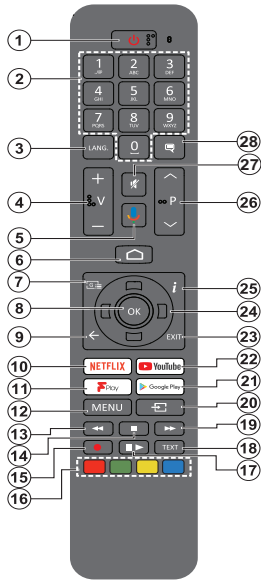

Note: Other Panasonic devices cannot be operated with this remote.

Inserting the Batteries into the Remote

The remote may have a screw that secures the battery compartment cover onto the remote control (or this may be in a separate bag). Remove the screw, if the cover is screwed on previously. Then remove the battery compartment cover to reveal the battery compartment. Insert two 1.5V - size **AAA** batteries. Make sure the (+) and (-) signs match (observing correct polarity). Do not mix old and new batteries. Replace only with same or equivalent type. Place the cover back on. Secure the cover again with the screw, if any.

To pair remote with the TV

When the TV is turned on for the first time, a search for accessories will be performed after the initial setup starts. You will need to pair your remote control with your TV at this point.

Press and hold the **Source** button on the remote until the LED on the remote starts to blink, then release the **Source** button. That means the remote is in pairing mode.

Now you will wait for the TV to find your remote. Select the name of your remote and press **OK** when it appears on the TV screen.

When the pairing process is successful, the LED on the remote will go off. If the pairing process fails the remote will enter sleep mode after 30 seconds.

In order to pair your remote later on, you can go to **Settings** menu, highlight **Remotes & Accessories** option and press **OK** to start a search for accessories.

1. **Standby:** Quick Standby / Standby / On
2. **Numeric buttons:** Switches the channel in Live TV mode, enters a number or a letter in the text box on the screen
3. **Language:** Switches among sound modes (analogue TV), displays and changes audio language (digital TV, where available)
4. **Volume +/-**
5. **Microphone:** Activates the microphone on the remote
6. **Home:** Opens the Home Screen
7. **Guide:** Displays the electronic programme guide in Live TV mode
8. **OK:** Confirms selections, enters sub-menus, views channel list (in Live TV mode)
9. **Back/Return:** Returns to previous menu screen, goes one step back, closes open windows, closes teletext (in Live TV-Teletext mode)
10. **Netflix:** Launches the Netflix application
11. **Freeview Play:** Connects to the Freeview Play platform where you can access available catch-up TV services
12. **Menu:** Displays Live TV Settings menu (in Live TV mode), displays available setting options such as sound and picture
13. **Rewind:** Moves frames backwards in media such as movies
14. **Stop:** Stops the media being played
15. No function
16. **Coloured Buttons:** Follow the on-screen instructions for coloured button functions
17. **Pause:** Pauses the media being played
18. **Text:** Opens and closes teletext (where available in Live TV mode)
19. **Fast forward:** Moves frames forward in media such as movies
20. **Source:** Shows all available broadcast and content sources, is also used in pairing process of the remote.
21. **Google Play:** Launches the Google Play Store application
22. **YouTube:** Launches the YouTube application
23. **Exit:** Closes and exits from Live TV Settings menus, closes the Home Screen, exits from any running application or menu or OSD banner, switches to last set source
24. **Directional buttons:** Navigates menus, setting options, moves the focus or cursor, etc. and displays the subpages in Live TV-Teletext mode when pressed Right or Left. Follow the on-screen instructions.
Note: Directional buttons are positioned on the circle around the OK button.
25. **Info:** Displays information about on-screen content
26. **Programme +/-:** Increases/Decreases channel number in Live TV mode
27. **Mute:** Completely turns off the volume of the TV
28. **Subtitles:** Turns subtitles on and off (where available)

Standby Button

Press and hold the **Standby** button on the remote control. **Power off** dialogue will appear on the screen. Highlight **OK** and press the **OK** button. The TV will switch into standby mode. Press briefly and release to switch the TV into quick standby mode or to switch on the TV when in quick standby or standby mode.

Initial Setup Wizard

Note: Follow the on-screen instructions to complete the initial setup process. Use the directional buttons and the **OK** button on the remote to select, set, confirm and proceed.

When turned on for the first time, a welcome screen will be displayed. Select your language and press **OK**. Follow the on-screen instructions to setup your TV and install channels. The installation wizard will guide you through the setup process. You can perform initial setup anytime using the **Factory reset** option in the **Settings>Device Preferences>About** menu. You can access the **Settings** menu from the Home screen or from the **TV options** menu in Live TV mode.

1. Welcome Message and Language Selection

"Welcome" message will be displayed along with the language selection options listed on the screen. Select the desired language from the list and press **OK** to continue.

2. Region/Country

In the next step select your region or country from the list and press **OK** to continue.

3. Initial Setup

After the region/country selection you can start the initial setup wizard. Highlight **Continue** and press **OK** to proceed. You will not be able to go back and change the language and region/country once you proceed. If you need to change your language or region/country selection after this step, you will have to switch the TV into standby mode so the setup process starts from the beginning when you next switch on the TV. In order to do this, press and hold the **Standby** button. A dialogue will be displayed. Highlight **OK** and press **OK**.

4. Search for accessories

A search for accessories will be performed after the initial setup has started. Follow the on-screen instructions to pair your remote control (depends on the model of the remote control) and other wireless accessories with your TV. Press **Back/Return** button to end adding accessories and proceed.

5. Quick Setup

If you didn't priorly connect your TV to the Internet via Ethernet a screen will be displayed where you can transfer your Android phone's WLAN network and Google Account to your TV. Highlight **Continue** and press **OK** to proceed. Follow the on-screen instructions on your TV and your phone to complete the process. You can also skip this step by selecting **Skip** option. Some steps may be skipped depending on the settings made in this step.

If you did priorly connect your TV to the Internet via Ethernet a message will be displayed stating that you are connected. You can choose to continue with wired connection or change the network. Highlight **Change**

network and press **OK** if you want to use wireless connection instead of wired connection.

6. Network Connection

You will be directed to the next step automatically, if you connect your TV to the Internet via Ethernet at this point. If not, available wireless networks will be searched and listed on the next screen. Select your WLAN network from the list and press **OK** to connect. Enter the password using the virtual keyboard if the network is password protected. Select the **Other network** option from the list, if the network that you want to connect has hidden SSID.

If you prefer not to connect to the Internet at this point you can skip this step by selecting **Skip** option. You can connect to the Internet later using the **Network & Internet** menu options in the **Settings** menu from the Home Screen or from the **TV options** menu in Live TV mode.

This step will be skipped if internet connection has been established in the previous step.

7. Network Privacy Policy

Network Privacy Policy screen will be displayed next. Read the related explanations displayed on the screen. You can use Up and Down directional buttons to scroll through and read the entire text. Highlight **Accept** and press **OK** on the remote to confirm and proceed. You can change this setting later using **Network Privacy Policy** option in the **Settings>Network & Internet** menu.

This step will be skipped if no internet connection has been established in the previous step.

8. Sign in to your Google account

If connection succeeds, you can sign in to your Google account on the next screen. You need to be signed in to a Google account in order to use Google services. This step will be skipped if no internet connection has been established in the previous step or if you already signed in to your Google account in Quick Setup step.

By signing in, you will be able to discover new apps for videos, music and games on Google Play; get personalised recommendations from apps like YouTube; buy or rent the newest movies and shows on Google Play Movies & TV; access your entertainment and control your media. Highlight **Sign In** and press **OK** to proceed. You can sign in to your Google account by entering your e-mail address or phone number and your password, or create a new account.

If you prefer not to sign in to your Google account at this point you can skip this step by selecting **Skip** option.

9. Terms of Service

Terms of Service screen will be displayed next. By continuing, you will agree to the Google Terms of Service, the Google Privacy Policy and the Google Play Terms of Service. Highlight **Accept** and press

OK on the remote to confirm and proceed. You can also view **Terms of Service**, **Privacy Policy** and **Play Terms of Service** on this screen. To display the content an internet connection is needed. A message will be displayed mentioning the web site address on which this information can also be viewed, in case internet access is not available.

10. Google Services

Select each to learn more about each service, such as how to turn it on or off later. Data will be used according to Google's Privacy Policy. Highlight **Accept** and press **OK** to confirm your selection of these Google services settings.

Use location

You can allow or disallow Google and third party apps to use your TV's location information. Highlight **Use location** and press **OK** to view detailed information and turn this feature on or off. You can change this setting later using **Location status** option in the **Settings>Device Preferences>Location** menu.

Help improve Android

Automatically send diagnostic information to Google, like crash reports and usage data from your device and apps. This information won't be used to identify you. Highlight **Help improve Android** and press **OK** to view detailed information and turn this feature on or off. You can change this setting later using the **Settings>Device Preferences>Usage & Diagnostics** menu.

Services and your privacy

Google Assistant sends services you talk to a unique code. That way, services can remember things like your preferences during conversations. You can view, manage and reset the data sent to services on each service's page in the Explore section of the Assistant mobile app. Learn more at g.co/assistant/idreset.

Information on Google services and some features of your TV will be displayed next. If you have signed in to your Google account in the previous steps, you can also turn on personal results for Assistant by choosing the related option when prompted. Press **OK** consecutively to proceed.

11. Terms and Conditions

Depending on the country selection you made in the earlier steps of the setup, you will need to agree to the terms and conditions of Freeview Play next, in order to make use of the related services. Scroll the page to read the entire text using the up/down directional buttons. Highlight **Accept** and press **OK** on the remote to confirm and proceed. Highlight **Terms and Conditions** and press **OK** to learn more. For further requirements for Freeview Play services refer to the **Freeview Play Platform** section.

12. Password

Depending on the country selection you made in the earlier steps, you may be asked to define a 4-digit password (PIN) at this point. Press **OK** to proceed. The selected PIN cannot be '0000'. This PIN will be required in order to access some menus, content or to release locked channels, sources, etc. You will have to enter it if you are asked to enter a PIN for any menu operation later.

13. Select TV Mode

In the following step of the initial setup, you can set the TV's operation mode either as **Home** or as **Store**. **Store** option will configure your TV's settings for store environment. This option is intended only for store use. It is recommended to select **Home** for home use.

14. Chromecast built-in always available

Select your chromecast availability preference. If set as **On** your TV will be detected as a Google Cast device and allow Google Assistant and other services to wake your TV up to respond to Cast commands, even when on standby mode and the screen is off.

15. Tuner Mode

The next step is the selection of the tuner mode. Select your tuner preference to install channels for Live TV function. **Antenna**, **Cable** and **Satellite** options are available. Highlight the option that corresponds to your environment and press **OK** or **Right** directional button to proceed. If you don't want to perform a tuner scan highlight **Skip** and press **OK**.

When the channel scan with the selected tuner is completed, the installation wizard will bring you back to this step. In case you want to continue scanning channels with another tuner, you can proceed as explained below.

Antenna

If **Antenna** option is selected, you can choose to search for digital terrestrial and analogue broadcasts. On the next screen highlight the option you prefer and press **OK** to start the search or select **Skip Scan** to continue without performing a search.

***Note:** If the country selected does not have analogue broadcasts, analogue channels may not be searched.*

Cable

If **Cable** option is selected, you can choose to search for digital cable and analogue broadcasts. If any, available operator options will be listed on the **Select Operator** screen. Otherwise this step will be skipped. You can select only one operator from the list. Highlight the desired operator and press **OK** or the **Right** directional button to proceed. On the next screen highlight the option you prefer and press **OK** to start the search or select **Skip Scan** to continue without performing a search. If one of the digital channel search options is selected a configuration screen will

be displayed next. **Scan Mode, Frequency (KHz), Modulation, Symbol Rate (Ksym/s), Network ID** options may need to be set. To perform a full scan set the **Scan Mode** as **Full** or **Advanced** if available. Depending on the selected operator and/or **Scan Mode** some options may not be available to be set.

Note: *If the country selected does not have analogue broadcasts, analogue channels may not be searched.*

Once you are done with setting available options, press the **Right** directional button to proceed. The TV will start to search available broadcasts.

Satellite

If **Satellite** option is selected, **Antenna Type** screen will be displayed next. If you have a Direct satellite system, you can proceed to the next step quickly by selecting the **Next** option here. Highlight **More** and press **OK** to set the antenna type manually. **Single, Tone Burst, DiSEqC and Unicable** options are available. Highlight the antenna type that corresponds to your satellite system and press **OK** or the **Right** directional button to proceed to the next step.

Next screen will be **Select Operator** screen. You can select only one operator from the list. Highlight the desired operator and press **OK** or the **Right** directional button to proceed. Some of the options in the following steps may be preset and/or additional steps may be added or some steps may be skipped depending on the selected operator in this step. Check the parameters in each step before proceeding and adjust if necessary. You can highlight **General** and press **OK** or **Right** directional button to proceed with normal satellite installation.

LNB List screen will be displayed next. You may be able to set up different satellites depending on the selected country, antenna type and operator in the previous steps. Highlight the desired satellite option and press **OK** or the **Right** directional button to set the parameters. The **Satellite Status** of the first satellite option will be set as **On**. In order to enable channel scan on the satellite, this option should be set as **On** first.

Following satellite parameters will be available. You may not be able to change all settings depending on the previous selections.

Satellite Status: Set the status option to **On** to enable channel search on the selected satellite. Highlight this option and press **OK** to change the status.

Satellite Selection: Select the satellite on which you want to perform a channel search.

Scan Mode: Set your scan mode preference. **Full** and **Network** options will be available. If you are going to perform a network scan, make sure that you have adjusted the **Frequency, Symbol Rate**

(Ksym/s) and **Polarisation** parameters under the **Transponder** option accurately.

Scan Type: You can perform a scan for free or encrypted channels only. If the **Free** option is selected encrypted channels will not be installed. Select **All** to scan all channels.

Store Type: You can select to store TV channels (referred to as 'Digital Channels' in the menu) or radio channels only. Select **All** to store all channels.

Transponder: Adjust the **Frequency, Symbol Rate (Ksym/s)** and **Polarisation** parameters for the selected satellite if necessary.

LNB Configurations: Set the parameters for LNB. For DiSEqC antenna type select the correct DiSEqC port corresponding to your satellite system. Set other parameters in accordance with your satellite system if necessary.

Signal Quality: The signal quality status is displayed as a percentage.

Signal Level: The signal level status is displayed as a percentage.

Press the **Back/Return** button and select next satellite you want to set. After you completed the configuration changes, highlight **Next** on the **LNB List** screen and press **OK** or **Right** directional button to proceed.

If **Load Preset List** option is selected in the previous step next steps will be skipped and the preset channel list installation will start. If the correct satellite has not been selected for SatcoDX installation, a warning dialogue will be displayed on the screen. The satellite/s that can be selected will be listed. Press **OK** to close the dialogue and then set the satellite accordingly.

Channel Scan screen will be displayed next. Select **Skip Scan** to proceed without performing a scan and complete the initial setup. Select **Only digital channels** and press **OK** or the **Right** directional button to start the search. While the search continues you can press the **Back/Return** button, highlight **Skip Scan** and press **OK** or **Right** directional button to stop the search. The channels that have already been found will be stored in the channel list.

When the initial setup is completed a message will be displayed. Press **OK** to finish the setup.

You will be asked to give your consent to the collection of your data. Read the text on the screen for detailed information. Highlight **Accept** and press **OK** to give your consent and proceed. To skip without giving your consent, select **Skip**. You can change this setting later using the **Settings>Device Preferences>Manufacturer Usage & Diagnostics** menu.

Home Screen will be displayed. You can press the **Exit** button on the remote to switch to Live TV mode and watch TV channels.

Home Screen

To enjoy the benefits of your Android TV, your TV must be connected to the Internet. Connect the TV to a home network with a high-speed Internet connection. You can connect your TV wirelessly or wired to your modem/router. Refer to the **Network & Internet** and **Connecting to the Internet** sections for further information on how to connect your TV to the Internet.

The Home menu is the centre of your TV. From the Home menu, you can start any application, switch to a TV channel, watch a movie, or switch to a connected device. Press the **Home** button to display Home Screen. You can also select the **Android TV Home** option from the **Inputs** menu to switch to Home Screen. To open the **Inputs** menu, press the **Source** button on the remote or press the **Menu** button on the remote when the TV is in Live TV mode, highlight the **Source** option in the **TV options** menu, and press **OK**. Depending on your TV setup and your country selection in the initial setup, the Home menu may contain different items.

The available options of the Home Screen are positioned in rows. To navigate through the Home Screen options use the directional buttons on the remote. Apps, YouTube, Google Play Movies & TV, Google Play Music and Google Play related rows and rows of the applications you have installed might be available. Select a row then move the focus to the desired item in the row. Press **OK** button to make a selection or to enter a sub-menu.

On the upper left of the screen, search tools will be located. You can choose either to type a word to start a search via the virtual keyboard or try voice search option if your remote has a built-in microphone. Move the focus to the desired option and press **OK** to proceed.

On the upper right of the screen, **Notifications, Inputs, Network & Internet** (will be named as **Connected** or **Not Connected** according to the current connection status), **Settings** and the current time will be displayed. You can configure your date and time preferences using the **Date & Time** menu options from the **Settings>Device Preferences** menu.

First row will be the **Apps** row. **Live TV** and **Multi Media Player** apps will be available alongside with other favourite apps. If not, highlight **Add app to favourites** option (plus sign) on the **Apps** row and press **OK**. Then select the app you want to add and press **OK**. Repeat this procedure for each app. Highlight **Live TV** and press **OK** or press the **Exit** button on the remote to switch to Live TV mode. If the source was set to an option other than **Antenna, Cable, Satellite** or **ATV** previously, press the **Source** button and set one of these options to watch live TV channels. Highlight **Multi Media Player** and press **OK**

to browse the connected USB devices and play/display the installed media content on the TV. The audio can be played through the speakers of the TV or through the speaker systems connected to the TV. To browse the Internet, you will need an internet browser application. Make a search or launch the Google Play Store app, find a browser and download it.

For some countries, the Home Screen will be organised into several tabs. **Home, Discover** and **Apps** tabs will be available. You can scroll through the tabs using the directional buttons. Each tab will have a featured content row at the top. In the **Home** tab, there will be rows for favourite apps, recent Live TV programmes and recommendations from streaming apps. In the **Discover** tab recommendations from streaming services will be displayed. In the **Apps** tab, all the apps installed on your TV will be displayed and you can install more from Play Store using the related option. Depending on your TV setup and your country selection in the initial setup, the tabs on the Home Screen may contain different items.

Live TV Mode Menu Content

Switch the TV to Live TV mode first and then press the **Menu** button on the remote to see Live TV menu options. To switch to Live TV mode you can either press the **Exit** button or highlight the **Live TV** app from the **Apps** row on the Home Screen and press **OK**. For some countries, the **Live TV** app will be situated in the **Home** tab on the Home Screen and the row with this app will be named as **Favourite Apps**.

Channels

Programme Guide: Open the electronic programme guide. Refer to the **Programme Guide** section for detailed information.

Channel: Open the **Channel** menu. You can use the **Channels** menu options to search for broadcast channels. Refer to the **Channel** section for more information.

TV Options

Source: Display the list of input sources. Select the desired one and press **OK** to switch to that source.

Picture: Open the **Picture** menu. Refer to **Device Preferences** section for detailed information.

Sound: Open the **Sound** menu. Refer to **Device Preferences** section for detailed information.

Power: This menu has the same options as in **Settings>Device Preferences>Power** menu. Check the **Timer** and **Screen Saver** options in **Settings>Device Preferences** menu.

Sleep Timer: Define a time after which you want your TV to enter sleep mode automatically. Set as **Off** to disable.

Picture off: Select this option and press **OK** to turn the screen off. Press a button on the remote or on the TV to turn the screen on again. Note that you can not turn the screen on via the **Volume +/-**, **Mute** and **Standby** buttons. These buttons will function normally.

Switch Off Timer: Define a time after which you want your TV to switch off automatically. Set as **Off** to disable.

No Signal Auto Power Off: Set the behaviour of the TV, when no signal is detected from the currently set input source. Define a time after which you want your TV to turn itself off or set as **Off** to disable.

Auto Sleep: Define an idle time after which you want your TV to enter sleep mode automatically. **4 Hours**, **6 Hours** and **8 Hours** options are available. Set as **Never** to disable.

CI Card: Display available menu options of the CI card in use. This item may not be available depending on the input source setting.

Advanced Options

The options of this menu may change and/or appear as greyed out depending on the selected input source.

Audio Channel: Set your **Audio Channel** preference.

Audio Language: Set your language preference for audio. This item may not be available depending on the input source setting.

2nd Audio Language: Set one of the listed language options as second audio language preference.

Sound Tracks: Set your sound track preference, if any available.

Blue Mute: Turn this function on/off according to your preference. When turned on, blue background will be displayed on the screen when no signal is available.

Default Channel: Set your default startup channel preference. When the **Select Mode** is set as **User Select**, **Show Channels** option will become available. Highlight and press **OK** to see channel list. Highlight a channel and press **OK** to make a selection. Selected channel will be displayed, every time the TV is turned back on from any standby mode. If the **Select Mode** is set as **Last Status**, the last watched channel will be displayed.

Interaction Channel: Turn the Interaction Channel function on or off. This feature is useful in the UK and Ireland only.

MHEG PIN Protection: Turn the MHEG PIN protection function on or off. This setting enables or disables access some of the MHEG applications. Disabled applications can be released by entering

the right PIN. This feature is useful in the UK and Ireland only.

HBBTV Settings

HBBTV Support: Turn the HBBTV function on or off.

Do Not Track: Set your preference regarding the tracking behaviour for HBBTV services.

Cookie Settings: Set your cookie setting preference for HBBTV services.

Persistent Storage: Turn the Persistent Storage function on or off. If set as **On** cookies will be stored with an expiry date in the persistent memory of the TV.

Block Tracking Sites: Turn the Block Tracking Sites function on or off.

Device ID: Turn the Device ID function on or off.

Reset Device ID: Reset the device ID for HBBTV services. Confirmation dialogue will be displayed. Press **OK** to proceed, **Back** to cancel.

FreeviewPlay Settings: Press **OK** to display the terms and conditions for Freeview Play services. You can accept or decline using the related options on the side of the screen. Refer to **Freeview Play Platform** section for more information.

Subtitle

Analogue Subtitle: Set this option as **Off**, **On** or **Mute**. If **Mute** option is selected, the analogue subtitle will be displayed on the screen but the speakers will be muted simultaneously.

Digital Subtitle: Set this option as **Off** or **On**.

Subtitle Tracks: Set your subtitle track preference, if any available.

Digital Subtitle Language: Set one of the listed language options as first digital subtitle language preference.

2nd Digital Subtitle Language: Set one of the listed language options as second digital subtitle language preference. If the selected language in the **Digital Subtitle Language** option is not available, the subtitles will be displayed in this language.

Subtitle Type: Set this option as **Normal** or **Hearing Impaired**. If **Hearing Impaired** option is selected, it provides subtitle services to deaf and hard of hearing viewers with additional descriptions.

Teletext

Digital Teletext Language: Set the teletext language for digital broadcasts.

Decoding Page Language: Set the decoding page language for teletext display.

BISS Key: “Click To Add Biss Key” message will be displayed. Press **OK** button to add a biss key. **Frequency, Symbol Rate (KSym/s), Polarisation, Programme ID and CW Key** parameters will be available to be set. Once you are done with the settings highlight **Save Key** and press **OK** to save and add the biss key. This option will not be available if the input source is not set as **Satellite**. Available options will differ depending on the selected country during the initial setup process.

System Information: Display detailed system information on the current channel such as **Signal Level, Signal Quality, Frequency**, etc.

Settings

You can access the **Settings** menu from the Home Screen or from the **TV options** menu in Live TV mode.

Network & Internet

You can configure your TV's network settings using the options of this menu. You can also highlight the Connected/Not Connected icon on the Home screen and press **OK** to access this menu.

Network Privacy Policy: Display network privacy policy. You can use Up and Down directional buttons to scroll through and read the entire text. Highlight **Accept** and press **OK** to give your consent.

Wi-Fi: Turn the wireless LAN (WLAN) function on and off.

Available networks

When the WLAN function is turned on, available wireless networks will be listed. Highlight **See all** and press **OK** to see all networks. Select one and press **OK** to connect. You may be asked to enter a password to connect to the selected network, in case the network is password protected. Additionally you can add new networks by using the related options.

Other options

Add new network: Add networks with hidden SSID's.

Scanning always available: You can let the location service and other apps scan for networks, even when WLAN function is turned off. Press **OK** to turn it on and off.

Wow: Turn this function on and off. This function allows you to turn on or awaken your TV via wireless network.

Wol: Turn this function on and off. This function allows you to turn on or awaken your TV via network.

Ethernet

Connected/Not connected: Displays the status of the internet connection via Ethernet, IP and MAC addresses.

Proxy settings: Set a HTTP proxy for browser manually. This proxy may not be used by other apps.

IP settings: Configure your TV's IP settings.

Channel

The content of this menu may change depending on the selected input source and whether the channel installation is completed.

Channels

Options of this menu may change or become inactive depending on the input source and on the **Channel Installation Mode** selection.

Input Source - Antenna

Channel Scan: Start a scan for digital terrestrial channels. You can press the **Back/Return** button to cancel the scan. The channels that have already been found will be stored in the channel list.

Update Scan: Search for updates. Previously added channels will not be deleted, but any newly found channels will be stored in the channel list.

Single RF Scan: Select the **RF Channel** by using the Right/Left directional buttons. **Signal Level** and **Signal Quality** of the selected channel will be shown. Press **OK** to start scan on the selected RF channel. The found channels will be stored in the channel list.

Manual Service Update: Start a service update manually.

LCN: Set your preference for LCN. LCN is the Logical Channel Number system that organises available broadcasts in accordance with a recognisable channel number sequence (if available).

Channel Scan Type: Set your scan type preference.

Channel Store Type: Set your store type preference.

Favourite Network Select: Select your favourite network. This menu option will be active, if more than one network is available.

Channel Skip: Set channels to be skipped when switching the channels via **Programme +/-** buttons on the remote. Highlight the desired channel/s on the list and press **OK** to select/unselect.

Channel Swap: Replace the positions of the two selected channels in the channel list. Highlight the desired channels on the list and press **OK** to select. When the second channel is selected, the position of this channel will be replaced with the position of the first selected channel. You can press the **Yellow** button and enter the number of the channel you want to select. Then highlight **OK** and press **OK** to go to that channel. You may need to set the **LCN** option to **Off** in order to enable this feature.

Channel Move: Move a channel to the position of another channel. Highlight the channel you want to move and press **OK** to select. Then do the same for a

second channel. When the second channel is selected, you can press the **Blue** button and the first selected channel will be moved to the position of that channel. You can press the **Yellow** button and enter the number of the channel you want to select. Then highlight **OK** and press **OK** to go to that channel. You may need to set the **LCN** option to **Off** in order to enable this feature.

Channel Edit: Edit channels in the channel list. Edit the name of the selected channel and display **Network Name**, **Channel Type** and **Frequency** information related to that channel if available. Depending on the channel other options may also be editable. Press **OK** or the **Yellow** button to edit the highlighted channel. You can press the **Blue** button to delete the highlighted channel.

Channel Delete: Highlight the desired channel/s on the list and press **OK** or the **Yellow** button to select/unselect. Then press the **Blue** button to delete the selected channel/s.

Clear Channel List: Delete all channels stored in the channel list. A dialogue will be displayed for confirmation. Highlight **OK** and press **OK** button to proceed. Highlight **Cancel** and press **OK** to cancel.

Input Source - Cable

Channel Scan: Start a scan for digital cable channels. If available, operator options will be listed. Select the desired one and press **OK**. **Scan Mode**, **Frequency** and **Network ID** options may be available. The options may vary depending on the operator and the **Scan Mode** selections. Set the **Scan Mode** as **Full** if you don't know how to set up other options. Highlight **Scan** and press **OK** or the **Right** directional button to start the scan. You can press the **Back/Return** button to cancel the scan. The channels that have already been found will be stored in the channel list.

Single RF Scan: Enter the **Frequency** value. **Signal Level** and **Signal Quality** of the selected **Frequency** will be shown. Highlight the **Scan** option and press **OK** or the **Right** directional button to start scan. The found channels will be stored in the channel list.

LCN: Set your preference for LCN. LCN is the Logical Channel Number system that organises available broadcasts in accordance with a recognisable channel number sequence (if available).

Channel Scan Type: Set your scan type preference.

Channel Store Type: Set your store type preference.

Favourite Network Select: Select your favourite network. This menu option will be active, if more than one network is available. This option may not be available depending on the selected country during the initial setup process.

Channel Skip: Set channels to be skipped when switching the channels via **Programme +/-** buttons

on the remote. Highlight the desired channel/s on the list and press **OK** to select/unselect.

Channel Swap: Replace the positions of the two selected channels in the channel list. Highlight the desired channels on the list and press **OK** to select. When the second channel is selected, the position of this channel will be replaced with the position of the first selected channel. You can press the **Yellow** button and enter the number of the channel you want to select. Then highlight **OK** and press **OK** to go to that channel. You may need to set the **LCN** option to **Off** in order to enable this feature.

Channel Move: Move a channel to the position of another channel. Highlight the channel you want to move and press **OK** to select. Then do the same for a second channel. When the second channel is selected, you can press the **Blue** button and the first selected channel will be moved to the position of that channel. You can press the **Yellow** button and enter the number of the channel you want to select. Then highlight **OK** and press **OK** to go to that channel. You may need to set the **LCN** option to **Off** in order to enable this feature.

Channel Edit: Edit channels in the channel list. Edit the name of the selected channel and display **Network Name**, **Channel Type**, **Frequency**, **Modulation** and **Symbol Rate** information related to that channel. Depending on the channel other options may also be editable. Press **OK** or the **Yellow** button to edit the highlighted channel. You can press the **Blue** button to delete the highlighted channel.

Channel Delete: Highlight the desired channel/s on the list and press **OK** or the **Yellow** button to select/unselect. Then press the **Blue** button to delete the selected channel/s.

Clear Channel List: Delete all channels stored in the channel list. A dialogue will be displayed for confirmation. Highlight **OK** and press **OK** button to proceed. Highlight **Cancel** and press **OK** to cancel.

Input Source - Satellite

Satellite Re-scan: Start a satellite scan beginning with the antenna selection screen. When this scanning option is preferred, some scanning configurations will not be available and thus the preferences you made during the initial setup process may not be changed.

For the **General Satellite** channel installation mode **SatcoDX Scan** option may also be available here. Copy the relevant sdx file into the root directory of an USB storage device and connect it to your TV. Highlight this option and press **OK**. **Download SatcoDX** option will be highlighted, press **OK** to continue. Select the sdx file from the connected USB storage device on the next screen and press **OK**. Satellite selection screen will be displayed. The status of the first satellite option will appear as **On**. Highlight that satellite option and press **OK**. Set the parameters corresponding to your system

and correct satellite and press the **Back/Return** button to return to the satellite selection screen. Highlight **Next** and press **OK** to proceed with the SatcoDX channel list installation. If the selected satellite is not correct for SatcoDX installation, a warning dialogue will be displayed on the screen. The satellite/s that can be selected will be listed. Press **OK** to close the dialogue and press **Back/Return** to return to satellite selection screen. Then set the satellite accordingly.

Satellite Add: Add satellite and perform a satellite scan. This menu option will be active, if **Channel Installation Mode** is set to **General Satellite**.

Satellite Update: Search for any updates by repeating the previous scan with the same settings. You will also be able to configure these settings before the scan. If **Channel Installation Mode** is set to **Preferred Satellite** this option may be named differently depending on the available services. Highlight the satellite and press **OK** button to configure detailed satellite parameters. Then press the **Back/Return** button to return to the satellite selection screen. Highlight **Next** and press **OK** to proceed.

Satellite Manual Tuning: Start a manual satellite scan. Highlight the satellite and press **OK** button to configure detailed satellite parameters. Then highlight **Next** and press **OK** to proceed.

Favourite Network Select: Select your favourite network. This menu option will be active, if more than one network is available. This option may not be available depending on the selected country during the initial setup process.

Channel Skip: Set channels to be skipped when switching the channels via **Programme +/-** buttons on the remote. Highlight the desired channel/s on the list and press **OK** to select/unselect.

Channel Swap: Replace the positions of the two selected channels in the channel list. Highlight the desired channels on the list and press **OK** to select. When the second channel is selected, the position of this channel will be replaced with the position of the first selected channel. You can press the **Yellow** button and enter the number of the channel you want to select. Then highlight **OK** and press **OK** to go to that channel.

Channel Move: Move a channel to the position of another channel. Highlight the channel you want to move and press **OK** to select. Then do the same for a second channel. When the second channel is selected, you can press the **Blue** button and the first selected channel will be moved to the position of that channel. You can press the **Yellow** button and enter the number of the channel you want to select. Then highlight **OK** and press **OK** to go to that channel.

Channel Edit: Edit channels in the channel list. Edit the name and channel number of the selected channel and display **Network Name**, **Channel Type** and **Fre-**

quency information related to that channel if available. Depending on the channel other options may also be editable. Press **OK** or the **Yellow** button to edit the highlighted channel. You can press the **Blue** button to delete the highlighted channel.

Channel Delete: Highlight the desired channel/s on the list and press **OK** or the **Yellow** button to select/unselect. Then press the **Blue** button to delete the selected channel/s.

Clear Channel List: Delete all channels stored in the channel list. A dialogue will be displayed for confirmation. Highlight **OK** and press **OK** button to proceed. Highlight **Cancel** and press **OK** to cancel.

Note: Some options may not be available and appear as greyed out depending on the operator selection and operator related settings.

Channel Installation Mode

Set this option as **Preferred Satellite** or **General Satellite**. The channel list will also change depending on the selected option here. In order to watch the channels on the satellite you want, this option should be selected accordingly. Set to **Preferred Satellite** to watch operator channels, if you have performed an operator installation. Set to **General Satellite** to watch other satellite channels, if you have performed a normal installation.

Auto Channel Update

Turn the auto channel update function on or off.

Channel Update Message

Turn the channel update message function on or off.

Parental Controls

() To enter this menu PIN should be entered first. Use the PIN that you have defined during the initial setup process. If you have changed the PIN after the initial setup use that PIN. If you didn't set a PIN during the initial setup, you can use the default PIN. The default PIN is 1234. Some options may not be available or vary depending on the country selection during the initial setup. The content of this menu may not be displayed if the channel installation is not completed and no channels are installed.*

Channels Blocked: Select channel/s to be blocked from the channel list. Highlight a channel and press **OK** to select/unselect. To watch a blocked channel PIN should be entered first.

Programme Restrictions: Block programmes according to the age rating information that is being broadcasted with them. You can turn on or off restrictions, set rating systems, age limits, and block unrated programmes using the options of this menu.

Inputs Blocked: Prevent access to the selected input source content. Highlight the desired input option and press **OK** to select/unselect. To switch to a blocked input source PIN should be entered first.

Change PIN: Change the PIN you defined during the initial setup. Highlight this option and press **OK**. You will need to enter the current PIN first. Then new PIN entry screen will be displayed. Enter the new PIN twice for confirmation.

Open Source Licences

Display Open Source Software licence information.

Accounts & Sign In

Highlight this option and press **OK** to sign into your Google account. Following options will be available if you have signed into your Google account.

Google: You can configure your data syncing preferences or remove your registered account on the TV. Highlight a service listed in the **Choose synced apps** section and press **OK** to enable/disable data sync. Highlight **Sync now** and press **OK** to sync all enabled services at once.

Add account: Add a new one to available accounts by signing in to it.

Apps

Using the options of this menu, you can manage the apps on your TV.

Recently opened apps

You can display recently opened apps. Highlight **See all apps** and press **OK** to see all the apps installed on your TV. The amount of storage space that they needed will also be displayed. You can see the version of the app, open or force to stop the running of the app, uninstall a downloaded app, see the permissions and turn them on/off, turn on/off the notifications, clear the data and cache, etc. Highlight an app and press **OK** to see available options.

Changing the storage location of an app

If you did priorly format your USB storage device as device storage to extend the storage capacity of your TV, you can move the app to that device. For more information refer to the **Storage** section in the **Settings>Device Preferences** menu.

Highlight the app you want to move and press **OK** to see available options. Then highlight the **Storage used** option and press **OK**. If the selected app is convenient you will see your USB storage device as an option for this app to be stored. Highlight that option and press **OK** to move the app.

Note that the apps that moved to a connected USB storage device will not be available if that device is disconnected. And if you format the device with the TV as removable storage, don't forget to back up the apps using the related option. Otherwise, the apps stored on that device will not be available after formatting. For more information refer to the **Storage** section in the **Settings>Device Preferences** menu.

Permissions

Manage the permissions and some other features of the apps.

App permissions: The apps will be sorted by permission type categories. You can enable/disable permissions for the apps from within these categories.

Special app access: Configure some app features and special permissions.

Security & restrictions: You can allow or restrict installation of apps from sources other than the Google Play Store.

Device Preferences

About: Check for system updates, change the device name, reset the TV to the factory defaults and display system information such as network addresses, serial numbers, versions, etc. You can also display legal information, manage advertisements, display your advertising ID, reset it and turn on/off the personalised advertisements based on your interests.

Factory reset: Reset all TV settings to the factory defaults. Highlight **Factory reset** and press **OK**. A confirmation message will be displayed, select **Factory reset** to proceed with resetting. A further confirmation message will be displayed, select **Erase everything** to factory reset the TV. The TV will switch off/on first and the initial setup will start. Select **Cancel** to exit.

Note: You may be asked to enter a PIN to proceed with the reset operation. Enter the PIN you have defined during the initial setup. If you didn't set a PIN during the initial setup, you can use the default PIN. The default PIN is 1234.

Netflix ESN: Displays your ESN number. ESN number is an unique ID number for Netflix, created especially to identify your TV.

Date & Time: Set the date and time options of your TV. You can set your TV to automatically update the time and date data over the network or over the broadcasts. Set corresponding to your environment and preference. Disable by setting as **Off** if you want to manually change the date or time. Then set date, time, time zone and hour format options.

Timer

Power On Time Type: Set your TV to turn on by itself. Set this option as **On** or **Once** to enable a power on timer to be set, set as **Off** to disable. If set as **Once** the TV will turn on only once at the defined time in **Auto Power On Time** option below.

Auto Power On Time: Available if the **Power On Time Type** is enabled. Set the desired time for your TV to come on from standby using the directional buttons and press **OK** to save the new set time.

Power Off Time Type: Set your TV to turn off by itself. Set this option as **On** or **Once** to enable a

power off timer to be set, set as **Off** to disable. If set as **Once** the TV will turn off only once at the defined time in **Auto Power Off Time** option below.

Auto Power Off Time: Available if the **Power Off Time Type** is enabled. Set the desired time for your TV to go to standby using the directional buttons and press **OK** to save the new set time.

Language: Set your language preference.

Keyboard: Select your keyboard type and manage keyboard settings.

Inputs: Show or hide an input terminal, change the label for an input terminal, and configure the options for HDMI CEC (Consumer Electronic Control) function and display the CEC device list.

Power: This menu has the same options as in **TV Options>Power** menu. Check the **Timer** and **Screen Saver** options in **Settings>Device Preferences** menu.

Sleep Timer: Define a time after which you want your TV to enter sleep mode automatically. Set as **Off** to disable.

Picture Off: Select this option and press **OK** to turn the screen off. Press a button on the remote or on the TV to turn the screen on again. Note that you can not turn the screen on via the **Volume +/-**, **Mute** and **Standby** buttons. These buttons will function normally.

Switch Off Timer: Define a time after which you want your TV to switch off automatically. Set as **Off** to disable.

No Signal Auto Power Off: Set the behaviour of the TV, when no signal is detected from the currently set input source. Define a time after which you want your TV to turn itself off or set as **Off** to disable.

Auto Sleep: Define an idle time after which you want your TV to enter sleep mode automatically. **4 Hours**, **6 Hours** and **8 Hours** options are available. Set as **Never** to disable.

Picture

Picture Mode: Set the picture mode to suit your preference or requirements. Picture mode can be set to one of these options: **Standard**, **Vivid**, **Sport**, **Movie** and **Game**.

Dolby Vision Modes: If Dolby Vision content is detected Dolby Vision Bright, Dolby Vision Dark and Dolby Vision Vivid picture mode options will be available instead of other picture modes.

Backlight, **Brightness**, **Contrast**, **Colour**, **HUE**, **Sharpness** settings will be adjusted according to the selected picture mode.

Dolby Vision Notification: Set your notification appearance preference for Dolby Vision content. When turned on, Dolby Vision logo will be displayed on the screen when Dolby Vision content is detected.

Auto Backlight: Set your auto backlight preference. **Off**, **Low**, **Middle** and **Eco** options will be available. Set as **Off** to disable.

Backlight: Adjust the backlight level of the screen manually. This item will not be available if the **Auto Backlight** is not set as **Off**.

Brightness: Adjust the brightness value of the screen.

Contrast: Adjust the contrast value of the screen.

Colour: Adjust the colour saturation value of the screen.

HUE: Adjust the hue value of the screen.

Sharpness: Adjust the sharpness value for the objects displayed on the screen.

Gamma: Set your gamma preference. **Dark**, **Middle** and **Bright** options will be available.

Colour Temperature: Set your colour temperature preference. **User**, **Cool**, **Standard** and **Warm** options will be available. You can adjust red, green and blue gain values manually. If one of these values is changed manually, **Colour Temperature** option will be changed to **User**, if not already set as **User**.

Display Mode: Set the aspect ratio of the screen. Select one of the predefined options according to your preference.

HDR: Turn the HDR function on or off. This item will be available if HDR content is detected.

Advanced Video

DNR: Dynamic Noise Reduction (DNR) is the process of removing noise from digital or analogue signals. Set your DNR preference as **Low**, **Medium**, **Strong**, **Auto** or turn it off by setting as **Off**.

MPEG NR: MPEG Noise Reduction cleans up block noise around outlines and noise on the background. Set your MPEG NR preference as **Low**, **Medium**, **Strong** or turn it off by setting as **Off**.

Max Vivid: Manipulates contrast and colour perception, basically converts Standard Dynamic Range picture to High Dynamic Range picture. Set as **On** to enable.

Adaptive Luma Control: Adaptive Luma control adjusts contrast settings globally according to content histogram in order to provide deeper black and brighter white perception. Set your Adaptive Luma Control preference as **Low**, **Medium**, **Strong** or turn it off by setting as **Off**.

Local Contrast Control: Local contrast control divides each frame to defined small regions and provides ability to apply independent contrast setting for each region. This algorithm improves fine details and provides better contrast perception. It makes higher depth impression by enhancing dark and bright areas without any detail loss. Set

your Local Contrast Control preference as **Low**, **Medium**, **High** or turn it off by setting as **Off**.

Flesh Tone: Adjusts the skin tone brightness. Set your preference as **Low**, **Medium**, or **High** to enable. Set as **Off** to disable.

DI Film Mode: It is the function for 3:2 or 2:2 cadence detection for 24 fps film content and improves the side effects (like interlacing effect or judder) which are caused by these pull down methods. Set your DI Film Mode preference as **Auto** or turn it off by setting as **Off**. This item will not be available if Game Mode or PC Mode is turned on.

Blue Stretch: Human eye perceives cooler whites as brighter white, Blue Stretch feature changes White balance of mid-high grey levels to cooler colour temperature. Turn the Blue Stretch function on or off.

Game Mode: Game mode is the mode which cuts down some of the picture processing algorithms to keep up with video games that have fast frame rates. Turn the Game Mode function on or off.

ALLM: ALLM (Auto Low Latency Mode) function allows the TV to activate or deactivate low latency settings depending on playback content. Highlight this option and press **OK** to turn the ALLM function on or off.

PC Mode: PC Mode is the mode which cuts down some of the picture processing algorithms to keep signal type as it is. It can be usable especially for RGB inputs. Turn the PC Mode function on or off.

De-Contour: Decreases the contour effects in low-resolution content and auto streaming services. Set your preference as **Low**, **Middle**, or **High** to enable. Set as **Off** to disable.

MJC: Optimises the TV's video settings for motional images to acquire a better quality and readability. Highlight this option and press **OK** to see available options. **Effect**, **Demo Partition**, and **Demo** options will be available. Set the **Effect** option to **Low**, **Middle**, or **High** to enable the MJC function. When enabled, **Demo Partition** and **Demo** options will become available. Highlight **Demo Partition** and press **OK** to set your preference. **All**, **Right** and **Left** options will be available. Highlight **Demo** and press **OK** to activate the demo mode. While the demo mode is active, the screen will be divided into two sections, one displaying the MJC activity, the other displaying the normal settings for the TV screen. If the **Demo Partition** option is set to **All**, both sides will display the MJC activity.

HDMI RGB Range: This setting should be adjusted according to input RGB signal range on HDMI source. It can be limited range (16-235) or full range (0-255). Set your HDMI RGB range preference. **Auto**, **Full** and **Limit** options will be

available. This item will not be available, if the input source is not set as HDMI.

Low Blue Light: Electronic device screens emit blue light that can cause eye strain and may lead to eye problems over time. To reduce the effect of blue light set your preference as **Low**, **Middle**, or **High**. Set as **Off** to disable.

Colour Space: You can use this option to set the range of colours displayed on your TV screen. When set as **On**, colours are set according to the source signal. When set as **Auto**, the TV decides to set this function as on or off dynamically, according to source signal type. When set as **Off**, the TV's maximum colour capacity is used by default.

Colour Tuner: Colour saturation, hue, brightness can be adjustable for red, green, blue, cyan, magenta, yellow and flesh tone (skin tone) for having more vivid or more natural image. Set the **HUE**, **Colour**, **Brightness**, **Offset** and **Gain** values manually. Highlight **Enable** and press **OK** to turn this function on.

11 Point White Balance Correction: White balance feature calibrates TV's colour temperature in detailed grey levels. By visually or measurement, grey scale uniformity can be improved. Adjust the strength of the **Red**, **Green**, **Blue** colours and **Gain** value manually. Highlight **Enable** and press **OK** to turn this function on.

Reset to Default: Reset the video settings to factory default settings.

Note: Depending on the currently set input source some menu options may not be available.

Sound

System Sounds: System sound is the sound played when navigating or selecting an item on the TV screen. Highlight this option and press **OK** to turn this function on or off.

Sound Style: For easy sound adjustment, you can select a preset setting. **User**, **Standard**, **Vivid**, **Sports**, **Movie**, **Music** and **News** options will be available. Sound settings will be adjusted according to the selected sound style. Some other sound options may become unavailable depending on the selection.

Balance: Adjust the left and right volume balance for speakers and headphones.

Sound Surround: Turn the surround sound feature on or off.

Equalizer Detail: Adjust the equalizer values according to your preferences.

Speakers Delay: Adjust the delay value for speakers.

eARC: Set your eARC preference. **Off** and **Auto** options will be available. Set as **Off** to disable.

Digital Output: Set the digital sound output preference. **Auto, Bypass, PCM, Dolby Digital Plus and Dolby Digital** options will be available. Highlight the option you prefer and press **OK** to set.

Digital Output Delay: Adjust the digital output delay value.

Auto Volume Control: With Auto Volume Control, you can set the TV to automatically level out sudden volume differences. Typically at the beginning of adverts or when you are switching channels. Turn this option on/off by pressing **OK**.

Downmix Mode: Set your preference to convert multi-channel audio signals to two-channel audio signals. Press **OK** to see the options and set. **Stereo** and **Surround** options will be available. Highlight the option you prefer and press **OK** to set.

Dolby Audio Processing: With Dolby Audio Processing, you can improve the sound quality of your TV. Press **OK** to see the options and set. Some other sound options may become unavailable and appear as greyed out depending on the settings made here. Set the **Dolby Audio Processing** option to **Off** if you would like to change these settings.

Dolby Audio Processing: Highlight this option and press **OK** to turn this function on/off.

Sound Mode: If the **Dolby Audio Processing** option is turned on **Sound Mode** option will be available to set. Highlight the **Sound Mode** option and press **OK** to see the preset sound modes.

Game, Movie, Music, News, Stadium and Smart options will be available. Highlight the option you prefer and press **OK** to set.

Dolby Atmos: Your TV supports Dolby Atmos technology. By means of this technology the sound moves around you in three-dimensional space, so you feel like you're inside the action. You will have best experience if input audio bitstream is Atmos. Turn this option on/off by pressing **OK**.

Reset to Default: Resets the sound settings to factory defaults.

Storage: View the total storage space status of the TV and connected devices if available. To see detailed information on the usage details highlight and press **OK**. There will also be options for ejecting and setting up the connected USB storage devices as device storage.

Eject: To keep your content safe, eject your USB storage device before you unplug it from your TV.

Erase & format as device storage: You can use the connected USB storage device to extend the storage capacity of your TV. After doing this, that device will only be usable with the TV. Follow the on-screen instructions and read the information displayed on the screen before proceeding.

Note: Formatting the connected storage device will erase all data installed on it. Back up the files that you want to keep before you proceed with formatting the device.

Erase & format as removable storage: If you did not previously format your USB storage device as device storage, it will only be usable with your TV. You can use this option to format it again in order to use it with other devices. Before proceeding with the formatting, you may consider backing up the data on your device to your TV's internal storage or to another USB storage device using the **Back up apps** option. Otherwise, some apps may not work properly after formatting. Follow the on-screen instructions and read the information displayed on the screen before proceeding.

Note: Formatting the connected storage device will erase all data installed on it. Back up the files that you want to keep before you proceed with formatting the device.

You can also go to the **Notifications** section on the Home Screen after connecting your USB device to your TV to see the available options. Highlight the notification related to your connected USB device and press **OK**.

Browse: Opens the **Storage** menu.

Setup as device storage: Has the same functionality as the **Erase & format as device storage** option described above.

Eject: Same as described above.

Home Screen: Customise your Home Screen. Select channels which will be displayed on the Home Screen, enable/disable video and audio previews. Organise apps and games, change their order or get more of them. Display open source licences.

For some countries, the Home Screen will be organised into several tabs and this menu will contain additional options to customise the content of these tabs. Highlight **Set up** and press **OK** to sign in to a Google account, so you can browse personalised recommendations for that account in the **Discover** tab on the Home Screen. After signing in, using the related options in this menu, you can view your account activity controls and permissions, customise services and define content preferences to get better recommendations.

Store Mode: Highlight **Store mode** and press **OK**. A dialogue will be displayed asking for your confirmation. Read the description, highlight **Continue** and press **OK** if you want to proceed. Then highlight **On** to activate or **Off** to deactivate and press **OK**. In store mode your TV's settings will be configured for store environment and the supported features will be displayed on the screen. Once activated, **Store Messaging** and **PQ Demo** settings will become available. Set according to your preferences. It is recommended not to activate store mode for home use.

Google Assistant: Highlight **On** and press **OK** to turn this feature on or off. Select your active account, view permissions, select which apps to include in search results, activate safe search filter and offensive word blocking, view open source licences.

Chromecast Built-in: Set your remote control notification preference. Highlight **Let others control your cast media** and press **OK**. **Always, While Casting** and **Never** options will be available. You can display open source licences and view version number and serial number under the **About** section.

Screen Saver: Set the screensaver options for your TV. You can choose a screensaver, set wait time for the screensaver or start the screensaver mode.

Energy Saver: Define a time after which you want your TV to turn itself off for energy saving. Set as **Never** to disable.

Location: You can allow the use of the wireless connection to estimate the location, see the recent location requests and allow or restrict the listed apps to use your location information.

Usage & Diagnostics: Automatically send usage data and diagnostic information to Google. Set according to your preference.

Manufacturer Usage & Diagnostics: If you accept, your TV will send diagnostic information (such as MAC address, country, language, software and firmware versions, bootloader versions and the source of the TV) and anonymous usage data from your device to a server located in Ireland. We are not able to identify you and are only collecting and storing this diagnostic information and anonymous usage data to ensure your device operates properly.

Accessibility: Configure **Audio Type, Visually Impaired, AC4 Dialogue Enhancement, Captions, Text to Speech** settings and/or turn **High Contrast Text** on/off. Some of the caption settings may not be applied.

Visually Impaired: Set the **Audio Type as Audio Description** to enable this option. Digital TV channels can broadcast special audio commentary describing on-screen action, body language, expressions and movements for people with visual disabilities.

Speaker: Turn this option on if you want to hear the audio commentary through the TV speakers.

Headphone: Turn this option on if you want to route the sound of the audio commentary to the TV's headphone output.

Volume: Adjust the volume level of the audio commentary.

Pan and Fade: Turn this option on if you want to hear the audio commentary more clearly, when it is available through broadcast.

Audio for the Visually Impaired: Set the audio type for visually impaired. Options will be available depending on the selected broadcast.

Fader Control: Adjust the volume balance between the main TV audio (**Main**) and audio commentary (**AD**).

Restart: A confirmation message will be displayed, select **Restart** to proceed with restarting. The TV will switch off/on first. Select **Cancel** to exit.

Remote & Accessories

You can use wireless accessories, such as your remote control (depends on the model of the remote control), headphones, keyboards or game controllers with your Android TV. Add devices to use them with your TV. Select this option and press **OK** to start searching available devices in order to pair them with your TV. If available highlight **Add accessory** option and press **OK** to start the search. Set your device to pairing mode. Available devices will be recognised and listed or pairing request will be displayed. To start pairing, select your device from the list and press **OK**, or highlight **OK** and press **OK** when the pairing request appears.

Connected devices will also be listed here. To unpair a device, highlight it and press **OK**. Then highlight the **Unpair** option and press **OK**. Then select **OK** and press **OK** again to unpair the device from the TV. You can also change the name of a connected device. Highlight the device and press **OK**, then highlight **Change name** and press **OK** again. Press **OK** again and use the virtual keyboard to change the name of the device.

Channel List

The TV sorts all stored channels in the **Channel List**. Press the **OK** button to open the **Channel List** in Live TV mode. You can press the **Red** button to scroll up the list page by page, or press the **Green** button to scroll down.

Several channel list options will be available. Press the **Right** and **Left** directional buttons to switch from one list to another. **Favourites, HD channels, Interactive channels, IP channels, Radio channels** and **All channels** options can be selected. Switch to **All channels** option to see all installed channels in the channel list.

Note: If any option except **All channels** is selected in the channel list, you can only switch to the channels that are currently listed in the channel list.

If you press the **Yellow** button the Freeview Play's mini guide will be opened and the integrated on demand applications will be displayed. Now you can press **Blue** button to search events, **Green** button to see the recommendations and **Red** button to see what is on TV now. The functions of the coloured buttons will

change depending on the selected option. Follow the instructions on the screen for current button functions.

Editing the Channels and the Channel List

You can edit the channels and the channel list using the **Channel Skip**, **Channel Swap**, **Channel Move**, **Channel Edit** and **Channel Delete** options under the **Settings>Channel>Channels** menu. You can access the **Settings** menu from the Home Screen or from the **TV options** menu in Live TV mode.

*Note: The channel editing options may not be available and/or appear as greyed out depending on the operator selection and operator related settings. You can turn off the **LCN** setting in the **Settings>Channel** menu, as it prevents channel editing. This option might be set to **On** by default depending on the selected country during the initial setup process.*

Managing Favourite Channel List

You can create a list of your favourite channels. This list will include only the channels that are specified by you. To add a channel to your favourite list highlight the desired channel in the channel list and press the **Blue** button on the remote. The channel will be added to your favourite list. To remove that channel from the list, highlight the channel and press **Blue** button.

If you want to list only your favourite channels, press the **Left** or **Right** directional button to switch to **Favourites** channel list option while channel list is displayed.

Programme Guide

By means of Electronic Programme Guide (EPG) function of your TV, you can browse the event schedule of the currently installed channels on your channel list. It depends on the related broadcast whether this feature is supported or not.

In order to access the Electronic Programme Guide press the **Guide** button on the remote. Use the directional buttons to navigate through the programme guide. You can use the Up/Down directional buttons to switch to previous/next channel on the list, **Programme +/-** buttons to scroll up or down the list page by page and Right/Left directional buttons to select a desired event of the currently highlighted channel. If available, the full name, start-end time and duration of the highlighted event and a brief information about it will be displayed on the screen. Press **Info** button to see additional information on the highlighted event. Press **Back/Return** button to go back to guide screen.

Press **Blue** button to search events. Press **Yellow** button to see available on demand player applications. Press **Green** button to see the recommendations and box sets. You can also press **Red** button to open the schedule. Using the schedule you can see events of the current day, previous or next 7 days. Highlight the day and then the time and press **OK** to see the available events. New functions may also be assigned

to the coloured buttons on the remote when they are available. Follow the on-screen information for accurate button functions.

The guide can not be displayed if **Freeview Live TV** input source is blocked from the **Settings>Channel>Parental Controls>Inputs Blocked** menu in Live TV mode or on Home Screen.

Integrated Catch-Up Services

You can enjoy Freeview Play catch-up TV services that work directly through the electronic programme guide. Whilst you are on a channel press **Red** button to open the schedule and then use the directional buttons to select day and time and press **OK**. You will see content of the selected time on the guide. Available catch-up content may change according to broadcasters and will be marked with a play icon. Highlight the content you want to play back and press the **OK** button.

Make sure that your TV is connected to your home network in order to use the catch-up services. For further information regarding this matter and other requirements for Freeview Play services refer to the **Connecting to the Internet** and **Freeview Play Platform** sections.

Connecting to the Internet

You can access the Internet via your TV, by connecting it to a broadband system. It is necessary to configure the network settings in order to enjoy a variety of streaming content and internet applications. These settings can be configured from **Settings>Network & Internet** menu. You can also highlight the **Connected/Not Connected** icon on the Home screen and press **OK** to access this menu. For further information refer to **Network & Internet** section under the title of **Settings**.

Wired Connection

Connect your TV to your modem/router via an Ethernet cable. There is a LAN port on the rear side of your TV.

The status of the connection under the **Ethernet** section in the **Network & Internet** menu will change from **Not connected** to **Connected**.

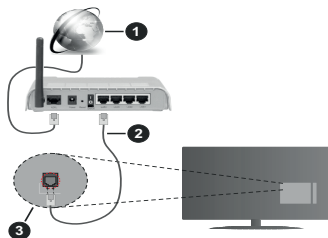

1. Broadband ISP connection
2. LAN (Ethernet) cable
3. LAN input on the rear side of the TV

You might be able to connect your TV to a network wall socket depending on your network's configuration. In that case, you can connect your TV directly to the network using an Ethernet cable.

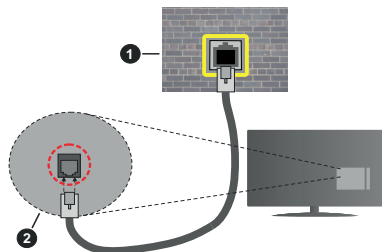

1. Network wall socket
2. LAN input on the rear side of the TV

Wireless Connection

A wireless LAN modem/router is required to connect the TV to the Internet via wireless LAN.

Highlight **Wi-Fi** option in the **Network & Internet** menu and press **OK** to enable wireless connection. Available networks will be listed. Select one and press **OK** to connect. For more information refer to **Network & Internet** section under the title of **Settings**.

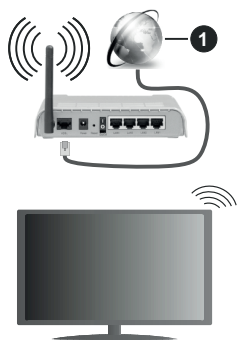

1. Broadband ISP connection

A network with hidden SSID can not be detected by other devices. If you want to connect to a network with hidden SSID, highlight the **Add new network** option under the **Settings>Network & Internet** menu on the Home Screen and press **OK**. Add the network by entering its name manually using the related option.

Some networks may have an authorisation system that requires a second login as such in a work environment. In this case, after connecting to the wireless network you want to connect to, highlight **Notifications** situated on the upper right of the **Home Screen** and press **OK**.

Then highlight the Sign in to **Wi-Fi network** notification and press **OK**. Enter your credentials to log in.

A Wireless-N router (IEEE 802.11a/b/g/n/ac) with simultaneous 2.4 and 5 GHz bands is designed to increase bandwidth. These are optimised for smoother and faster HD video streaming, file transfers and wireless gaming.

Use a LAN connection for quicker data transfer between other devices like computers.

The transmission speed differs depending on the distance and number of obstructions between the transmission products, the configuration of these products, the radio wave conditions, the line traffic and the products that you use. The transmission may also be cut off or may get disconnected depending on the radio wave conditions, DECT phones or any other WLAN 11b appliances. The standard values of the transmission speed are the theoretical maximum values for the wireless standards. They are not the actual speeds of data transmission.

The location where the transmission is most effective differs depending on the usage environment.

The Wireless feature of the TV supports 802.11 a,b,g,n & ac type modems. It is highly recommended that you should use the IEEE 802.11n communication protocol in order to avoid any possible problems while watching videos.

You must change your modem's SSID when there are any other modems around with the same SSID. You can encounter connection problems otherwise. Use a wired connection if you experience problems with a wireless connection.

A stable connection speed is required to play back streaming content. Use an Ethernet connection if the wireless LAN speed is unstable.

Multi Media Player

On the Home Screen scroll to **Apps** row, select **Multi Media Player (MMP)** and press the **OK** button to launch. If this app is not available, highlight **Add app to favourites** option (plus sign) on the **Apps** row and press **OK**. Then select the **Multi Media Player (MMP)** app and press **OK** to add. For some countries, the **Multi Media Player** app will be situated in the **Home** tab on the Home Screen and the row with this app will be named as **Favourite Apps**.

Select the media type on the main media player screen. On the next screen, you can press the **Menu** button to access a list of menu options while the focus is on a folder or a media file. Using the options of this menu you can change the media type, sort the files, change the thumbnail size and turn your TV into a digital photo frame. You will also be able to copy, paste and delete the media files using the related options of this menu, if a FAT32 formatted USB storage device is connected to

the TV. Additionally you can switch the viewing style by selecting either **Normal Parser** or **Recursive Parser**. In **Normal Parser** mode the files will be displayed with folders if any available. So only the selected type of media files in the root folder or in the selected folder will be displayed. If there isn't any media files of the selected type, the folder will be assumed as empty. In **Recursive Parser** mode the source will be searched for all available media files of the selected type and the found files will be listed. Press the **Back/Return** button to close this menu.

In order to activate photo frame feature select **Photo** as the media type. Then press the **Menu** button, highlight **Photo Frame** and press **OK**. If you select **One Photo mode** option and press **OK** the image that you set as photo frame image earlier will be displayed when photo frame feature is activated. If you select the USB storage device option the first file (in **Recursive Parser** mode) will be displayed. To set the photo frame image press the **Menu** button while the photo file of your choice is displayed, highlight **Photo Frame Image** and press **OK**.

Additionally, you can toggle between browsing modes by pressing the **Blue** button. List View and Grid View modes are available. While browsing for the video, photo and text files a preview of the highlighted file will be displayed in a small window on the left side of the screen if the browse mode is set to List View. You can also use **Programme +/-** buttons to jump directly to the first and last folder or file if the view style is set to Grid View.

Video Files

Press **OK** to play back the highlighted video file.

Info: Display the info bar. Press twice to display the extended information and the next file.

Pause/Play: Pause and resume the playback.

Rewind: Start reverse playback. Press consecutively to set the rewind speed.

Fast Forward: Start fast forward playback. Press consecutively to set the forward playback speed.

Stop: Stop the playback.

Programme +: Switch to next file.

Programme -: Switch to previous file.

Back/Return: Return to the media player screen.

Music Files

Press **OK** to play back the highlighted music/audio file.

Info: Display the extended information and the next file.

Pause/Play: Pause and resume the playback.

Rewind: Press and hold to rewind.

Fast Forward: Press and hold to fast forward.

Stop: Stop the playback.

Programme +: Switch to next file.

Programme -: Switch to previous file.

Back/Return: Return to the media player screen.

If you press **Back/Return** button without stopping the playback first the playback will continue while you are browsing in the multimedia player. You can use the media player buttons to control the playback. The playback will stop if you exit the media player or switch the media type to **Video**.

Photo Files

Press **OK** to display the highlighted photo file. When you press the **OK** button slide show will also start and all photo files in the current folder or in the storage device, depending on the viewing style, will be displayed in order. If the **Repeat** option is set to **None** only the files between the highlighted one and the last listed one will be displayed. Press the **OK** or **Pause/Play** button to pause or resume the slide show. The slide show will stop after the last listed file is displayed and media player screen will be displayed.

Info: Display the info bar. Press twice to display the extended information and the next file.

Pause/Play: Pause and resume the slide show.

Green button (Rotate/Duration): Rotate the image / Set the interval between the slides.

Yellow button (Zoom/Effect): Zoom in on the image / Apply various effects to the slide show.

Programme +: Switch to next file.

Programme -: Switch to previous file.

Back/Return: Return to the media player screen.

Text Files

When you press the **OK** button slide show will start and all text files in the current folder or in the storage device, depending on the viewing style, will be displayed in order. If the **Repeat** option is set to **None** only the files between the highlighted one and the last listed one will be displayed. Press the **OK** or **Pause/Play** button to pause or resume the slide show. The slide show will stop after the last listed file is displayed and media player screen will be displayed.

Info: Display the info bar. Press twice to display the extended information and the next file.

Pause/Play: Pause and resume the slide show.

Programme +: Switch to next file.

Programme -: Switch to previous file.

Directional buttons (Down or Right / Up or Left): Switch to next page / Switch to previous page.

Back/Return: Stop the slide show and return to the media player screen.

Menu Options

Press the **Menu** button to see available options while playing back or displaying media files. The content of this menu differs depending on the media file type.

Pause/Play: Pause and resume the playback or the slide show.

Repeat: Set the repeat option. Highlight an option and press **OK** to change the setting. If **Repeat One** option is selected the current media file will be repeatedly played back or displayed. If the **Repeat All** option is selected all media files of the same type in the current folder or in the storage device, depending on the viewing style, will be repeatedly played back or displayed.

Shuffle On/Off: Turn the shuffle option on or off. Press **OK** to change the setting.

Duration: Set the interval between the slides. Highlight an option and press **OK** to change the setting. You can also press the **Green** button to set. This option will not be available if the slide show is paused.

Rotate: Rotate the image. The image will be rotated 90 degrees clockwise each time you press **OK**. You can also press the **Green** button to rotate. This option will not be available if the slide show is not paused.

Effect: Apply various effects to the slide show. Highlight an option and press **OK** to change the setting. You can also press the **Yellow** button to set. This option will not be available if the slide show is paused.

Zoom: Zoom in on the image that is currently being displayed. Highlight an option and press **OK** to change the setting. You can also press the **Yellow** button to zoom in. This option will not be available if the slide show is not paused.

Font: Set the font options. Size, style and colour can be set according to your preferences.

Show Info: Display the extended information.

Photo Frame Image: Set the currently displayed image as photo frame image. This image will be displayed if the **One Photo mode** is selected instead of the connected storage device while activating the photo frame feature. Otherwise all files will be played back as a slide show when photo frame feature is activated.

Hide/Show Spectrum: Hide or show the spectrum if available.

Lyric Options: Display lyric options if available.

Picture Off: Open the power menu of your TV. You can use the **Picture off** option here to turn the screen off. Press a button on the remote or on the TV to turn the screen on again.

Screen Mode: Set the aspect ratio option.

Picture Settings: Display the picture settings menu.

Sound Settings: Display the sound settings menu.

Sound Tracks: Set the soundtrack option if more than one available.

Last Memory: Set to **Time** if you want to resume the playback from the position where it was stopped next time you open the same video file. If set to **Off** the playback will start from the beginning. Highlight an option and press **OK** to change the setting.

Seek: Jump to a specific time of the video file. Use the numeric and directional buttons to enter the time and press **OK**.

Subtitle Encoding: Display subtitle encoding options if available.

From USB Connection

IMPORTANT! Back up the files on your USB storage devices before connecting them to the TV. Manufacturer will not be responsible for any file damage or data loss. Certain types of USB devices (e.g. MP3 Players) or USB hard disk drives/memory sticks may not be compatible with this TV. The TV supports FAT32 disk formatting, NTFS is not supported. FAT32 formatted devices with a storage capacity larger than 2TB are not supported. Files larger than 4 GB are not supported.

You can view your photos, text documents or play your music and video files installed on a connected USB storage device on the TV. Plug in the USB storage device to one of the USB inputs on the TV.

On the main media player screen select the desired media type. On the next screen, highlight a file name from the list of available media files and press the **OK** button. Follow the on-screen instructions for more information on other available button functions.

Note: Wait a little while before each plugging and unplugging as the player may still be reading files. Failure to do so may cause physical damage to the USB player and the USB device itself. Do not pull out your drive while playing a file.

CEC

With CEC function of your TV you can operate a connected device with the TV remote control. This function uses HDMI CEC (Consumer Electronics Control) to communicate with the connected devices. Devices must support HDMI CEC and must be connected with an HDMI connection.

In order to make use of the CEC functionality the related option in the menu should be switched on. To check, switch on or off the CEC function, do the following:

- Enter the **Settings>Device Preferences>Inputs** menu on the Home Screen or **TV options>Settings>Device Preferences>Inputs** menu in Live TV mode.
- Scroll down to **Consumer Electronic Control (CEC)** section. Check if the **HDMI control** option is switched on.
- Highlight the **HDMI control** option and press **OK** to switch on or off.

Make sure that all CEC settings are properly set up on the connected CEC device. The CEC functionality has different names on different brands. CEC function might not work with all devices. If you connect a device with HDMI CEC support to your TV, the related HDMI input source will be renamed with the connected device's name.

To operate the connected CEC device, select the related HDMI input source from the **Inputs** menu on the Home Screen. Or press the **Source** button if the TV is in Live TV mode and select the related HDMI input source from the list. To terminate this operation and control the TV via the remote again, press the **Source** button, which will still be functional, on the remote and switch to another source.

The TV remote is automatically able to control the device once the connected HDMI source has been selected. However not all buttons will be forwarded to the device. Only devices that support CEC Remote Control function will respond to the TV remote control.

The TV supports also eARC (Enhanced Audio Return Channel) feature. Similar to ARC, the eARC feature enables the transfer of the digital audio stream from your TV to a connected audio device via the HDMI cable. eARC is an improved version of ARC. It has a much higher bandwidth than its predecessor. Bandwidth represents the range of frequencies or amount of data that is being transferred at a time. Higher bandwidth translates into a higher amount of data that can be transferred. Higher bandwidth also means that digital audio signal doesn't have to be compressed and is much more detailed, rich, and vibrant.

When eARC is enabled from the sound menu, TV first tries to establish eARC link. If eARC is supported by the connected device, the output turns into eARC mode and the "eARC" indicator can be observed on the connected device's OSD. If an eARC link cannot be established (for example, the connected device is not supporting eARC but supporting ARC only) or if eARC is disabled from the sound menu, then TV initiates ARC.

In order to activate ARC feature the **eARC** option should be set as **Auto**. You can access this option from the **TV options>Settings>Device Preferences>Sound menu** in Live TV mode or from **Settings>Device Preferences>Sound** menu on the Home Screen. When eARC is active, TV will mute its other audio outputs automatically. So you will hear audio from the connected audio device only. The volume control buttons of the remote will be directed to the connected audio device and you will be able to control the volume of the connected device with your TV remote.

For eARC to function properly;

- The connected audio device should also support eARC.

- Some HDMI cables do not have enough bandwidth to carry high-bit-rate audio channels, use an HDMI cable with eARC support (HDMI High Speed Cables with Ethernet and the new Ultra High Speed HDMI Cable - check hdmi.org for latest info).

Note: eARC is supported only via the HDMI2 input.

Google Cast

With the built-in Google Cast technology you can cast the content from your mobile device straight to your TV. If your mobile device has Google Cast feature, you can mirror your device's screen to your TV wirelessly. Select Cast screen option on your android device. Available devices will be detected and listed. Select your TV from the list and tap on it to start casting. You can get the network name of your TV from the **Settings>Device Preferences>About** menu on the Home screen. **Device name** will be one of the shown options. You can also change the name of your TV. Highlight **Device name** and press **OK**. Then highlight **Change** and press **OK** again. You can either select one of the predefined names or enter a custom name.

To cast your device's screen to the TV screen...

1. On your android device, go to 'Settings' from the notification panel or home screen
2. Tap on 'Device Connectivity'
3. Tap on the 'Easy projection' and enable 'Wireless projection'. Available devices will be listed
4. Select the TV you would like to cast to
or
 1. Slide down the notification panel
 2. Tap on 'Wireless projection'
 3. Select the TV you would like to cast to

If the mobile app is Cast-enabled, such as YouTube, Dailymotion, Netflix, you can cast your app to your TV. On the mobile app, look for the Google Cast icon and tap on it. Available devices will be detected and listed. Select your TV from the list and tap on it to start casting.

To cast an app to the TV screen...

1. On your smartphone or tablet, open an app that supports Google Cast
2. Tap the Google Cast icon
3. Select the TV you would like to cast to
4. The app you selected should start playing on TV

Notes:

Google Cast works on Android and iOS. Make sure that your mobile device is connected to the same network as your TV.

The menu options and namings for Google Cast function on your Android device can differ from brand to brand and can change with time. Refer to your device's manual for latest information on Google Cast function.

HBBTV System

HbbTV (Hybrid Broadcast Broadband TV) is a standard that seamlessly combines TV services delivered via broadcast with services delivered via broadband and also enables access to the Internet only services for consumers using connected TVs and set-top boxes. Services delivered through HbbTV include traditional broadcast TV channels, catch-up services, video on demand, electronic programme guide, interactive advertising, personalisation, voting, games, social networking and other multimedia applications.

HbbTV applications are available on channels where they are signalled by the broadcaster.

The HbbTV applications are generally launched with the press of a coloured button on the remote. Generally a small red button icon will appear on the screen in order to notify the user that there is an HbbTV application on that channel. Press the button indicated on the screen to launch the application.

HbbTV applications use the buttons on the remote control to interact with the user. When an HbbTV application is launched, the control of some buttons are owned by the application. For example, numeric channel selection may not work on a teletext application where the numbers indicate teletext pages.

HbbTV requires AV streaming capability for the platform. There are numerous applications providing VOD (video on demand) and catch-up TV services. The **OK** (play&pause), **Stop**, **Fast forward**, and **Rewind** buttons on the remote control can be used to interact with the AV content.

Note: You can enable or disable this feature from the TV Options>Advanced Options>HBBTV Settings menu in Live TV mode.

Freeview Play Platform

Freeview Play platform provides catch-up TV and On Demand services. Simply press the **Freeview Play** button on your remote control to connect to the Freeview Play platform.

You will have to agree to the terms and conditions for Freeview Play services first if you did not agree to them during the initial setup. Highlight **Accept** and press **OK** on the remote to confirm and proceed. You can also display the terms and conditions using the **Freeview-Play Settings** option in the **TV Options>Advanced Options** menu in Live TV mode.

Integrated TV Player applications will be displayed. Select one and press the **OK** button. Then select a content that you want to play back and press the **OK** button to watch.

Catch-up content can also be accessed and played back directly from the TV Guide. Refer to the section **Programme Guide** for more information.

Accessible TV Guide

The Freeview Play Accessible TV Guide makes it simpler for you to find the shows you love that meet your accessibility needs. Learn more at freeview.co.uk/555.

Accessible TV Guide is available at Channel 555. Enter 555 using the numeric buttons on your remote while watching TV.

Requirements

The Freeview Play services may only be used if the following requirements are fulfilled:

- Connecting the TV to the internet. A minimum broadband speed of 2Mbps is required for proper operation of catch-up and on demand services.
- Agreeing to the terms and conditions of Freeview Play

Note: Freeview Play platform usage will count towards any monthly broadband data allowance. Only selected channels provide 7-day catch-up.

Quick Standby Search

If earlier an automatic search is performed, your TV will search for new or missing digital channels at 05:00 am every morning while in quick standby mode.

And if the **Auto Channel Update** option in the **Settings>Channel** menu is enabled the TV will wake up within 5 minutes after it is switched into quick standby mode and search for channels. Standby LED will blink during this process. Once the standby LED stops blinking the search process is completed. Any new found channels will be added to the channel list. If the channel list is updated, you will be informed on the changes at the next power on.

Software Update

Your TV is capable of finding and updating the software automatically via Internet.

To experience the best use of your TV and benefit from the latest improvements make sure your system is always up to date.

Software update via internet

On the Home Screen enter the **Settings>Device Preferences>About** menu in order to update your Android system version. Move the focus to the **System update** option and press **OK**. You will be informed about the system status and the time at which the device was last checked for an update will be displayed. The **Check for update** option will be highlighted, press **OK** if you want to check for an available update.

Note: Do not unplug the power cord during the reboot process. If the TV fails to come on after the upgrade, unplug, wait for two minutes then plug it back in.

Troubleshooting & Tips

TV does not switch on

- Make sure the power cord is plugged in securely to the power outlet.
- Disconnect the power cord from the power outlet. Wait for one minute then reconnect it.
- Press the **Standby/On** button on the TV.

TV does not respond to the remote control

- The TV requires some time to start up. During this time, the TV does not respond to the remote control or TV controls. This is normal behaviour.
- Check if the remote control is working by means of a mobile phone camera. Put the phone in camera mode and point the remote control to the camera lens. If you press any key on the remote control and you notice the infra red LED flicker through the camera, the remote control is working. The TV needs to be checked.

If you do not notice the flickering, the batteries may be exhausted. Replace the batteries. If the remote is still not working, the remote control might be broken and needs to be checked.

This method of checking the remote control is not possible with remote controls which are wirelessly paired with the TV.

No Channels

- Make sure that all cables are properly connected and that the correct network is selected.
- Make sure that the correct channel list is selected.
- Make sure that you have entered the correct channel frequency if you have done manual tuning.

No picture / distorted picture

- Make sure that the antenna is properly connected to the TV.
- Make sure that the antenna cable is not damaged.
- Make sure that the correct device is selected as the input source.
- Make sure that the external device or source is properly connected.
- Make sure that the picture settings are set correctly.
- Loud speakers, unearthed audio devices, neon lights, high buildings and other large objects can influence reception quality. If possible, try to improve the reception quality by changing the antenna direction or moving devices away from the TV.
- Change to a different picture format, if the picture does not fit the screen
- Make sure that your PC uses the supported resolution and refresh rate.

No sound / poor sound

- Make sure that the sound settings are correctly set.
- Make sure that all cables are properly connected.
- Make sure that the volume is not muted or set to zero, increase the volume to check.
- Make sure that the TV audio output is connected to the audio input on the external sound system.
- Sound may be coming from only one speaker. Check the balance settings from **Sound** menu.

Input sources - can not be selected

- Make sure that the device is connected to the TV.
- Make sure that all cables are properly connected.
- Make sure that you select the right input source which is dedicated to the connected device.
- Make sure that the right input source is not hidden from the **Inputs** menu.

HDMI Signal Compatibility

Source	Supported Signals	
HDMI	480i	60Hz
	480p	60Hz
	576i, 576p	50Hz
	720p	50Hz, 60Hz
	1080i	50Hz, 60Hz
	1080p	24Hz, 25Hz, 30Hz, 50Hz, 60Hz
	3840x2160p	24Hz, 25Hz, 30Hz, 50Hz, 60Hz
	4096x2160p	24Hz, 25Hz, 30Hz, 50Hz, 60Hz

In some cases a signal on the TV may not be displayed properly. The problem may be an inconsistency with standards from the source equipment (DVD, Set-top box, etc.). If you do experience such a problem please contact your dealer and also the manufacturer of the source equipment.

Supported File Formats for USB Mode

Video

Video Codec	Resolution	Bit Rate	Profile	Container
VP9	4096x2176@60fps	100Mbps	Profile 0/2, Level 5.1	MKV (.mkv), WebM (.webm)
HEVC/H.265	4096x2176@60fps	100Mbps	Main/Main10 Profile, High Tier @Level 5.1	MP4 (.mp4, .mov), 3GPP (.3gpp, .3gp), MPEG transport stream (.ts, .trp, .tp), MKV (.mkv), FLV (.flv), AVI (.avi), H265 (.265)
MPEG1/2	1920x1080@120fps	80Mbps	MP@HL	MPEG program stream (.DAT, .VOB, .MPG, .MPEG), MPEG transport stream (.ts, .trp, .tp), MP4 (.mp4, .mov), 3GPP (.3gpp, .3gp), AVI (.avi), MKV (.mkv), ASF (.asf), WMV (.wmv), OGM (.ogm)
MPEG4	1920x1080@120fps	40Mbps	<ul style="list-style-type: none"> Simple Profile Advanced Simple Profile @Level 5 GMC is not supported 	MP4 (.mp4, .mov), 3GPP (.3gpp, .3gp), AVI (.avi), MKV (.mkv), ASF (.asf), WMV (.wmv), FLV (.flv), OGM (.ogm), MPEG transport stream (.ts, .trp, .tp), MPEG program stream (.DAT, .VOB, .MPG, .MPEG)
Sorenson H.263	1920x1080@120fps	40Mbps		FLV (.flv), AVI (.avi)
H.263	1920x1080@120fps	40Mbps		FLV (.flv), MP4 (.mp4, .mov), 3GPP (.3gpp, .3gp), AVI (.avi), ASF (.asf), WMV (.wmv)
H.264	4096x2304@60fps	135Mbps	Main/High Profile @ Level 5.2	FLV (.flv), MP4 (.mp4, .mov), 3GPP (.3gpp, .3gp), MPEG transport stream (.ts, .trp, .tp), ASF (.asf), WMV (.wmv), AVI (.avi), MKV (.mkv), OGM (.ogm), MPEG program stream (.DAT, .VOB, .MPG, .MPEG), H264 (.264)
AVS	1920x1080@60fps	50Mbps	Jizhun profile @ Level 6.0.1.08.60	MPEG transport stream (.ts, .trp, .tp), MP4 (.mp4, .mov), AVS (.avs)
AVS+	1920x1080@60fps	50Mbps	Broadcasting Profile @ Level 6.0.1.08.60	MPEG transport stream (.ts, .trp, .tp), AVS (.avs)
AVS2	4096x2176@60fps	100Mbps	Main/Main-10bit Profile @Level 8.2.60	MPEG transport stream (.ts, .trp, .tp), AVS2 (.avs2)
WMV3	1920x1080@60fps	40Mbps		ASF (.asf), AVI (.avi), MKV (.mkv), WMV (.wmv), 3GPP (.3gpp, .3gp), MP4 (.mp4, .mov), OGM (.ogm)
VC1	1920x1080@60fps	40Mbps	<ul style="list-style-type: none"> Advanced Profile @ Level 3 Simple Profile Main Profile 	MPEG transport stream (.ts, .trp, .tp), ASF (.asf), WMV (.wmv), AVI (.avi), MKV (.mkv), 3GPP (.3gpp, .3gp), MP4 (.mp4, .mov), VC1 (.vc1)
Motion JPEG	1920x1080@30fps	40Mbps		AVI (.avi), 3GPP (.3gpp, .3gp), MP4 (.mp4, .mov), MKV (.mkv), FLV (.flv), OGM (.ogm)
VP8	1920x1080@60fps	50Mbps		MKV (.mkv), WebM (.webm), FLV (.flv), 3GPP (.3gpp, .3gp), MP4 (.mp4, .mov), AVI (.avi), OGM (.ogm)
RV30/RV40	1920x1080@60fps	40Mbps		RM (.rm, .rmvb), MKV (.mkv)
AV1	4096x2176@60fps	100Mbps	Main Profile @Level 5.1	MP4 (.mp4, .mov), MKV (.mkv), WebM (.webm)

Audio

Audio Codec	Sample rate	Channel	Bit Rate	Container	Note
MPEG1/2 Layer1	16KHz ~ 48KHz	Up to 2	32Kbps ~ 448Kbps	MP3 (.mp3), AVI (.avi), ASF (.asf), WMV (.wmv), DivX (.divx), MKV (.mkv, .mka), 3GPP (.3gpp, .3gp), MP4 (.mp4, .mov, m4a), MPEG transport stream (.ts, .trp, .tp), MPEG program stream (.DAT, .VOB, .MPG, .MPEG), FLV (.flv), WAV (.wav), OGM (.ogm)	
MPEG1/2 Layer2	16KHz ~ 48KHz	Up to 2	8Kbps ~ 384Kbps	MP3 (.mp3), AVI (.avi), ASF (.asf), WMV (.wmv), DivX (.divx), MKV (.mkv, .mka), 3GPP (.3gpp, .3gp), MP4 (.mp4, .mov, m4a), MPEG transport stream (.ts, .trp, .tp), MPEG program stream (.DAT, .VOB, .MPG, .MPEG), FLV (.flv), WAV (.wav), OGM (.ogm)	
MPEG1/2/2.5 Layer3	8KHz ~ 48KHz	Up to 2	8Kbps ~ 320Kbps	MP3 (.mp3), AVI (.avi), ASF (.asf), WMV (.wmv), DivX (.divx), MKV (.mkv, .mka), 3GPP (.3gpp, .3gp), MP4 (.mp4, .mov, m4a), MPEG transport stream (.ts, .trp, .tp), MPEG program stream (.DAT, .VOB, .MPG, .MPEG), FLV (.flv), WAV (.wav), OGM (.ogm)	
AC3(DD)	32KHz, 44.1KHz, 48KHz	Up to 5.1	32Kbps ~ 640Kbps	AC3 (.ac3), AVI (.avi), MKV (.mkv, .mka), DivX (.divx), 3GPP (.3gpp, .3gp), MP4 (.mp4, .mov, m4a), PEG transport stream (.ts, .trp, .tp), MPEG program stream (.DAT, .VOB, .MPG, .MPEG), WMV (.wmv), ASF (.asf), OGM (.ogm)	
EAC3(DDP)	EAC3(DDP)	Up to 5.1	32Kbps ~ 6Mbps	EAC3 (.ec3), AVI (.avi), MKV (.mkv, .mka), DivX (.divx), 3GPP (.3gpp, .3gp), MP4 (.mp4, .mov, m4a), MPEG transport stream (.ts, .trp, .tp), MPEG program stream (.DAT, .VOB, .MPG, .MPEG), WMV (.wmv), ASF (.asf), OGM (.ogm)	
AAC-LC, HEAAC	8KHz ~ 48KHz	Up to 5.1	AAC-LC: 12kbps~576kbps V1 6kbps ~ 288kbps V2: 3kbps ~ 144kbps	AAC (.aac), AVI (.avi), MKV (.mkv, .mka), DivX (.divx), 3GPP (.3gpp, .3gp), MP4 (.mp4, .mov, m4a), MPEG transport stream (.ts, .trp, .tp), MPEG program stream (.DAT, .VOB, .MPG, .MPEG), FLV (.flv), RM (.rm, .rmvb, .ra), WAV (.wav), WMV (.wmv), ASF (.asf), OGM (.ogm)	
WMA	8KHz ~ 48KHz	Up to 2	128bps ~ 320Kbps	ASF (.asf), WMV (.wma, .wmv), AVI (.avi), MKV (.mkv, .mka), 3GPP (.3gpp, .3gp), MP4 (.mp4, .mov)	WMA 7, WMA 8, WMA 9 Standard
WMA 10 Pro M0	8KHz ~ 48KHz	Up to 2	< 192kbps	ASF (.asf), WMV (.wma, .wmv), AVI (.avi), 3GPP (.3gpp, .3gp), MP4 (.mp4, .mov)	
WMA 10 Pro M1	8KHz ~ 48KHz	Up to 5.1	< 384kbps	ASF (.asf), WMV (.wma, .wmv), AVI (.avi), 3GPP (.3gpp, .3gp), MP4 (.mp4, .mov)	
WMA 10 Pro M2	8KHz ~ 96KHz	Up to 5.1	< 768kbps	ASF (.asf), WMV (.wma, .wmv), AVI (.avi), 3GPP (.3gpp, .3gp), P4 (.mp4, .mov)	

Audio Codec	Sample rate	Channel	Bit Rate	Container	Note
VORBIS	Up to 48KHz	Up to 2		MKV (.mkv, .mka), WebM (.webm), 3GPP (.3gpp, .3gp), MP4 (.mp4, .mov, m4a), Ogg (.ogg), WMV (.wmv), ASF (.asf), AVI (.avi)	Supports stereo decoding only
DTS	Up to 48KHz	Up to 5.1	< 1.5Mbps (Pure DTS core)	MPEG transport stream (.ts, .trp, .tp), MPEG program stream (.DAT, .VOB, .MPG, .MPEG), WAV (.wav), MKV (.mkv, .mka), 3GPP (.3gpp, .3gp), MP4 (.mp4, .mov, m4a), AVI (.avi), OGM (.ogm), DTS (.dts)	
DTS LBR	12KHz, 22KHz, 24KHz, 44.1KHz, 48KHz	Up to 5.1	Up to 2Mbps	MP4 (.mp4, .mov), 3GPP (.3gpp, .3gp), MPEG transport stream (.ts, .trp, .tp)	
DTS XLL	Up to 96KHz	Up to 6	Up to 6.123Mbps	MPEG transport stream (.ts, .trp, .tp, .mts, .m2ts), MP4 (.mp4, .mov), 3GPP (.3gpp, .3gp)	
DTS Master Audio	Up to 48KHz	Up to 6	Up to 24.537Mbps	MPEG transport stream (.ts, .trp, .tp, .mts, .m2ts), MP4 (.mp4, .mov), GPP (.3gpp, .3gp)	
LPCM	8KHz ~ 48KHz	Mono, Stereo, 5.1	64Kbps ~ 1.5Mbps	WAV (.wav), AVI (.avi), MKV (.mkv, .mka), 3GPP (.3gpp, .3gp), MP4 (.mp4, .mov, m4a), MPEG transport stream (.ts, .trp, .tp), MPEG program stream (.DAT, .VOB, .MPG, .MPEG), WMV (.wmv), ASF (.asf), FLV (.flv), OGM (.ogm)	
IMA-ADPCM MS-ADPCM	8KHz ~ 48KHz	Up to 2	32Kbps~384Kbps	WAV (.wav), AVI (.avi), MKV (.mkv, .mka), OGM (.ogm)	
G711 A/mu-law	8KHz	1	64Kbps	WAV (.wav), AVI (.avi), MKV (.mkv, .mka), FLV (.flv)	
LBR (cook)	8KHz, 11.025KHz, 22.05KHz, 44.1KHz	Up to 5.1	6Kbps ~ 128Kbps	RM (.rm, .rmvb, .ra)	
FLAC	8KHz~96KHz	Up to 7.1	< 1.6Mbps	MKV (.mkv, .mka), FLAC (.flac)	
OPUS	8KHz ~ 48KHz	Up to 6	6Kbps ~ 510Kbps	MKV (.mkv, .mka), WebM (.webm)	
AC4	44.1KHz, 48KHz	Up to 5.1 (MS12 v1.x) Up to 7.1 (MS12 v2.x)	Up to 1521kbps Per Presentation	MP4 (.mp4, .mov, m4a), MPEG transport stream (.ts, .trp, .tp), AC4 (.ac4)	
Fraunhofer MPEG-H TV Audio System	32KHz, 44.1KHz, 48KHz	Up to 16 core channels Up to 5.1 Channels Output	~1.2 Mbps	MP4 (.mp4, .mov), MKV (.mkv, .mka), MPEG transport stream (.ts, .trp, .tp, .mts, .m2ts)	
AMR-NB	8KHz	1	4.75~12.2Kbps	3GPP (.3gpp, .3gp), MP4 (.mp4, .mov, m4a)	
AMR-WB	16KHz	1	6.6 ~ 23.85Kbps	3GPP (.3gpp, .3gp), MP4 (.mp4, .mov, m4a)	

Picture

Image	Photo	Resolution (width x height)
JPEG	Base-line	15360 x 8640
	Progressive	1024 x 768
PNG	Non-Interlace	9600 x 6400
	Interface	1200 x 800
BMP		9600 x 6400
GIF		6400 x 4800
WebP		3840 x 2160
HEIF		4000 x 3000

Subtitle

Internal

File Extension	Container	Subtitle Codec
ts, trp, tp	TS	DVB Subtitle Teletext CC(EIA608) PGS
mp4	MP4	VobSub PGS TX3G
mkv	MKV	ASS SSA SRT VobSub PGS

External

File Extension	Subtitle Parser	Remark
.srt	SubRip	
.ssa/.ass	SubStation Alpha Advanced SubStation Alpha	
.smi	SAMI	
.sub	MicroDVD SubIdx (VobSub)	
.txt	TMPlayer	

Supported DVI Resolutions

When connecting devices to your TV's connectors by using a DVI converter cable (DVI to HDMI cable - not supplied), you can refer to the following resolution information.

	56Hz	60Hz	66Hz	70Hz	72Hz	75Hz
640x480		x				x
800x600	x	x				x
1024x768		x		x		x
1280x768		x				x
1280x960		x				
1360x768		x				
1366x768		x				
1280x1024		x		x		x
1400x1050		x				
1600x900		x				

Specification

TV Broadcasting	PAL BG/I/DK SECAM BG/DK			
Receiving Channels	VHF (BAND I/III) - UHF (BAND U) - HYPERBAND			
Digital Reception	Fully integrated digital terrestrial-cable-satellite TV (DVB-T-C-S) (DVB-T2, DVB-S2 compliant)			
Number of Preset Channels	12 200			
Channel Indicator	On Screen Display			
RF Aerial Input	75 Ohm (unbalanced)			
Operating Voltage	220-240V AC, 50Hz.			
Audio	Dolby Atmos			
Headphone	3.5 mm mini stereo jack			
Networked Standby Power Consumption (W)	< 2			
	TX-43LX650B TX-43LX650BZ TX-43LX660B	TX-50LX650B TX-50LX650BZ TX-50LX660B	TX-55LX650B TX-55LX650BZ TX-55LX660B	TX-65LX650B TX-65LX650BZ TX-65LX660B
Audio Output Power (WRMS.) (10% THD)	2 x 10 W	2 x 10 W	2 x 10 W	2 x 12 W
Power Consumption (W)	120 W	135 W	140 W	200 W
Weight (kg)	11 Kg	14 Kg	17 Kg	24,5 Kg
TV Dimensions DxLxH (with stand) (mm)	221 x 964 x 614	221 x 1119 x 704	221 x 1233 x 769	251 x 1452 x 890
TV Dimensions DxLxH (without stand) (mm)	68 x 964 x 560	68 x 1119 x 647	66 x 1233 x 711	72 x 1452 x 836
Display	16/9 43"	16/9 50"	16/9 55"	16/9 65"
Operation temperature and operation humidity	0°C up to 40°C, 85% humidity max			

For more product information, please visit EPREL:
<https://eprel.ec.europa.eu>.

EPREL registration number is available on
<https://eprel.panasonic.eu/product>.

Wireless LAN Transmitter Specifications

Frequency Ranges	Max Output Power
2400 - 2483.5 MHz (CH1 - CH13)	< 100 mW
5150 - 5250 MHz (CH36 - CH48)	< 200 mW
5250 - 5350 MHz (CH52 - CH64)	< 200 mW
5470 - 5725 MHz (CH100 - CH140)	< 200 mW

Country Restrictions

The Wireless LAN equipment is intended for home and office use in the UK & Ireland (and other countries following the relevant EU and/or UK directive) without any limitation except for the countries mentioned below.

Country	Restriction
Bulgaria	General authorisation required for outdoor use and public service
Italy	If used outside of own premises, general authorisation is required
Greece	Indoor use only for 5470 MHz to 5725 MHz band
Luxembourg	General authorisation required for network and service supply (not for spectrum)
Norway	Radio transmission is prohibited for the geographical area within a radius of 20 km from the centre of Ny-Alesund
Russian Federation	Indoor use only
Israel	5 GHz band only for 5180 MHz-5320 MHz range

The requirements for any country may change at any time. It's recommended that user checks with local authorities for the current status of their national regulations for 5 GHz wireless LAN's.

Standard

IEEE 802.11.a/b/g/n

Host Interface

USB 2.0

Security

WEP 64/128, WPA, WPA2, TKIP, AES, WAPI

Notice

DVB / Data broadcasting / IPTV functions

- This TV is designed to meet the standards (as of March, 2021) of DVB-T / T2 (MPEG2, MPEG4-AVC(H.264) and HEVC(H.265)) digital terrestrial services, DVB-C (MPEG2, MPEG4-AVC(H.264) and HEVC(H.265)) digital cable services and DVB-S (MPEG2, MPEG4-AVC(H.264) and HEVC(H.265)) digital satellite services.

Consult your local dealer for availability of DVB-T / T2 or DVB-S services in your area.

Consult your cable service provider for availability of DVB-C services with this TV.

- This TV may not work correctly with the signal which does not meet the standards of DVB-T / T2, DVB-C or DVB-S.

- Not all the features are available depending on the country, area, broadcaster, service provider, satellite and network environment.

- Not all CI modules work properly with this TV. Consult your service provider about the available CI module.

- This TV may not work correctly with CI module that is not approved by the service provider.

- Additional fees may be charged depending on the service provider.

- The compatibility with future services is not guaranteed.

- Internet apps are provided by their respective service providers, and may be changed, interrupted, or discontinued at any time.

Panasonic assumes no responsibility and makes no warranty for the availability or the continuity of the services.

- Panasonic does not guarantee operation and performance of peripheral devices made by other manufacturers; and we disclaim any liability or damage arising from operation and/or performance from usage of such other maker's peripheral devices.

Licences

The terms HDMI, HDMI High-Definition Multimedia Interface, and the HDMI Logo are trademarks or registered trademarks of HDMI Licensing Administrator, Inc.



Dolby, Dolby Vision, Dolby Atmos, and the double-D symbol are registered trademarks of Dolby Laboratories Licensing Corporation. Manufactured under licence from Dolby Laboratories. Confidential unpublished works. Copyright © 2012-2021 Dolby Laboratories. All rights reserved.



Google, Android, Android TV, Chromecast, Google Play and YouTube are trademarks of Google LLC.

This product contains technology subject to certain intellectual property rights of Microsoft. Use or distribution of this technology outside of this product is prohibited without the appropriate licence(s) from Microsoft.

Content owners use Microsoft PlayReady™ content access technology to protect their intellectual property, including copyrighted content. This device uses PlayReady technology to access PlayReady-protected content and/or WMDRM-protected content. If the device fails to properly enforce restrictions on content usage, content owners may require Microsoft to revoke the device's ability to consume PlayReady-protected content. Revocation should not affect unprotected content or content protected by other content access technologies. Content owners may require you to upgrade PlayReady to access their content. If you decline an upgrade, you will not be able to access content that requires the upgrade.

The "CI Plus" Logo is a trademark of CI Plus LLP.

This product is protected by certain intellectual property rights of Microsoft Corporation. Use or distribution of such technology outside of this product is prohibited without a licence from Microsoft or an authorised Microsoft subsidiary.



Disposal of Old Equipment and Batteries



Only for European Union and countries with recycling systems

These symbols on the products, packaging, and/or accompanying documents mean that used electrical and electronic products and batteries must not be mixed with general household waste.

For proper treatment, recovery and recycling of old products and batteries, please take them to applicable collection points in accordance with your national legislation.

By disposing of them correctly, you will help to save valuable resources and prevent any potential negative effects on human health and the environment.

For more information about collection and recycling, please contact your local municipality.

Penalties may be applicable for incorrect disposal of this waste, in accordance with national legislation.

Note for the battery symbol (bottom symbol):

This symbol might be used in combination with a chemical symbol. In this case it complies with the requirement set by the Directive for the chemical involved.



Declaration of Conformity (DoC)

Hereby, Panasonic Marketing Europe GmbH, declares that this TV is in compliance with the essential requirements and other relevant provisions of the Directive 2014/53/EU and Radio Equipment Regulations 2017.

If you want to get a copy of the original DoC of this TV, please visit the following website:

<http://www.ptc.panasonic.eu/compliance-documents>

Authorised Representative:

Panasonic Testing Centre

Panasonic Marketing Europe GmbH

Winsbergring 15, 22525 Hamburg, Germany

Web Site: <http://www.panasonic.com>

Sales and Support Information

Customer Communication Centre

- For customers within the UK: **0344 844 3899**
- For customers within Ireland: **01289 8333**
- Monday - Friday 9:00am - 5:00pm, (Excluding public holidays).
- For further support on your product, please visit our website: **www.panasonic.co.uk**

Direct Sales at Panasonic UK

- Order accessory and consumable items for your product with ease and confidence by phoning our Customer Communications Centre Monday - Friday 9:00am - 5:00pm, (Excluding public holidays).
- Or go on line through our Internet Accessory ordering application at **www.pas-europe.com**.
- Most major credit and debit cards accepted.
- All enquiries transactions and distribution facilities are provided directly by Panasonic UK.
- It couldn't be simpler!
- Also available through our Internet is direct shopping for a wide range of finished products. Take a browse on our website for further details.

Important Instruction

For your own safety read following instruction carefully before attempting to connect this unit to the mains supply.

MAINS (AC) OPERATION

The wires in the mains lead are coloured in accordance with the following code :

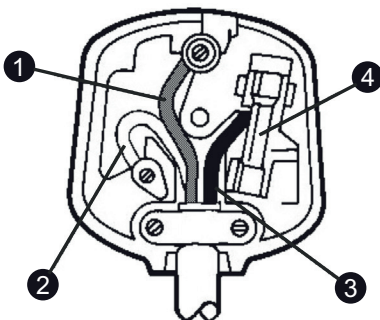

1. Green&Yellow (Earth) (if there is earth cable)
2. Blue (Neutral)
3. Brown (Live)
4. Fuse

IMPORTANT

As the colours of the wires in the mains lead of this appliance may not correspond with the coloured markings identifying the terminals in your plug, proceed as follows:

The wire which is coloured green and yellow must be connected to the terminal which is marked with the letter E, or by the earth symbol, or coloured green or green and yellow.

The wire which is coloured blue or black must be connected to the terminal which is marked with the letter N or coloured Black.

The wire which is coloured brown or red must be connected to the terminal which is marked with the letter L or coloured Red.

For continued protection against risk of fire, replace only with same type and rating of fuse (ASTA approved 5A 250VAC fuse).

CAUTION

TO PREVENT ELECTRIC SHOCK DISCONNECT FROM THE MAINS BEFORE REMOVING COVER. NO USER SERVICEABLE PARTS INSIDE. REFER SERVICING TO QUALIFIED SERVICE PERSONNEL.

SAFETY PRECAUTION

THIS EQUIPMENT MUST BE DISCONNECTED FROM THE MAINS WHEN NOT IN USE. DO NOT ALLOW THIS UNIT TO BE EXPOSED TO RAIN OR MOISTURE.



50638312