



Scan the QR code to see the manual.



OWNER'S MANUAL

WASHTOWER

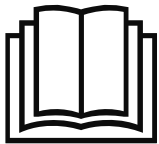

Before beginning installation, read these instructions carefully. This will simplify installation and ensure that the product is installed correctly and safely. Leave these instructions near the product after installation for future reference.

ENGLISH

WT1210*****



MFL71712185
Rev.02_031824

www.lg.com

Copyright © 2023-2024 LG Electronics Inc. All Rights Reserved.

TABLE OF CONTENTS

This manual may contain images or content that may be different from the model you purchased.

This manual is subject to revision by the manufacturer.

SAFETY INSTRUCTIONS

| | |
|---------------------------------------|----|
| READ ALL INSTRUCTIONS BEFORE USE..... | 4 |
| WARNING..... | 4 |
| CARING FOR THE ENVIRONMENT | 10 |

INSTALLATION

| | |
|---------------------------------------|----|
| Parts and Specifications | 13 |
| Installation Place Requirements | 17 |
| Unpacking the Appliance | 19 |
| Connecting the Water Supply Hose..... | 20 |
| Installing the Drain Hose | 22 |
| Levelling the Appliance | 24 |

OPERATION-WASHER

| | |
|--|----|
| Operation Overview..... | 26 |
| Preparing the Wash Load | 27 |
| Adding Detergents and Softeners | 28 |
| Control Panel and Programme Table..... | 30 |
| Extra Options and Functions | 36 |

OPERATION-DRYER

| | |
|--|----|
| Operation Overview..... | 39 |
| Preparing the Laundry | 40 |
| Control Panel and Programme Table..... | 42 |
| Extra Options and Functions | 47 |

SMART FUNCTIONS

| | |
|---------------------------------|----|
| Using LG ThinQ Application..... | 50 |
| Smart Diagnosis | 54 |

MAINTENANCE

| | |
|--------------|----|
| Washer | 55 |
| Dryer | 58 |

TROUBLESHOOTING

| | |
|--------------|----|
| Washer | 63 |
| Dryer | 70 |
| Common..... | 75 |

APPENDIX

| | |
|--------------------|----|
| Product Fiche..... | 76 |
|--------------------|----|

4 SAFETY INSTRUCTIONS

SAFETY INSTRUCTIONS

READ ALL INSTRUCTIONS BEFORE USE

The following safety guidelines are intended to prevent unforeseen risks or damage from unsafe or incorrect operation of the appliance. The guidelines are separated into 'WARNING' and 'CAUTION' as described below.

Safety Messages

 This symbol is displayed to indicate matters and operations that can cause risk. Read the part with this symbol carefully and follow the instructions in order to avoid risk.

 **WARNING**

This indicates that the failure to follow the instructions can cause serious injury or death.

 **CAUTION**

This indicates that the failure to follow the instructions can cause the minor injury or damage to the product.

WARNING

WARNING

- To reduce the risk of explosion, fire, death, electric shock, injury or scalding to persons when using this product, follow basic precautions, including the following:

Technical Safety

- This appliance can be used by children aged from 8 years and above and persons with reduced physical, sensory or mental capabilities or lack of experience and knowledge if they have been given supervision or instruction concerning use of the appliance in a safe way and understand the hazards involved. Children shall not play with the

appliance. Cleaning and user maintenance shall not be made by children without supervision.

- Children of less than 3 years should be kept away unless continuously supervised.
- The inlet water pressure must be between 50 kPa and 800 kPa.
- Use a new hose or hose-set supplied with the appliance. Reusing old hoses can cause a water leak and subsequent property damage.
- Ventilation openings must not be obstructed by a carpet.
- Do not dry unwashed items in the appliance.
- Fabric softeners, or similar products, should be used as specified by the fabric softener instructions.
- Remove all objects from pockets such as lighters and matches.
- Never stop the appliance before the end of the drying cycle unless all items are quickly removed and spread out so that the heat is dissipated.
- The appliance is not to be used if industrial chemicals have been used for cleaning.
- Items that have been soiled with substances such as cooking oil, vegetable oil, acetone, alcohol, petroleum, kerosene, spot removers, turpentine, waxes and wax removers should be washed in hot water with an extra amount of detergent before being dried in the appliance.
- Do not drink the condensed water. Failure to do so may result in food-borne illnesses.
- If the supply cord is damaged, it must be replaced by the manufacturer or its service agents or similarly qualified person in order to avoid a hazard.
- The lint filter must be cleaned frequently.
- Lint must not be allowed to accumulate around the appliance.
- Do not spray dry cleaning detergent directly onto the appliance or use the appliance to dry clothes left with dry cleaning detergent.

6 SAFETY INSTRUCTIONS

- Do not dry clothes stained with oil substances. Oil substances (including edible oils) stained on clothes cannot be completely removed even after washing with water.
- The appliance must not be supplied through an external switching device, such as a timer, or connected to a circuit that is regularly switched on and off by a utility.
- Remove clothes from the product immediately when drying is complete or the power is turned off during the drying process. Leaving clothes that has been dried in the appliance unattended could result in fire. Clothes not removed from the appliance after drying could result in fire. Remove clothes immediately after drying, and then hang or lay the clothes flat to cool.
- This appliance is intended to be used in household only.

Maximum Capacity

The maximum capacity in some cycles for dry clothes to be used is **Wash (12 kg)/Dry (10 kg)**.

Installation

- Never attempt to operate the appliance if it is damaged, malfunctioning, partially disassembled, or has missing or broken parts, including a damaged cord or plug.
- This appliance should only be transported by two or more people holding the appliance securely.
- Do not install the appliance in a damp and dusty place. Do not install or store the appliance in any outdoor area, or any area that is subject to weathering conditions such as direct sunlight, wind, rain, or temperatures below freezing.
- Make sure the power plug is completely pushed into the power outlet.
- Do not plug the appliance into multiple outlet sockets, power boards, or an extension power cable.

- Do not modify the power plug provided with the appliance. If it does not fit the power outlet, have a proper outlet installed by a qualified electrician.
- This appliance is equipped with a power cord having an equipment-earthing / grounding conductor (earthing pin) and a grounding power plug. The power plug must be plugged into an appropriate outlet socket that is installed and earthed / grounded in accordance with all local codes and ordinances.
- Improper connection of the equipment-grounding conductor can result in risk of electric shock. Check with a qualified electrician or service personnel if you are in doubt as to whether the appliance is properly grounded.
- This appliance must not be installed behind a lockable door, a sliding door or a door with a hinge on the opposite side to that of the appliance, in such a way that a full opening of the appliance door is restricted.
- Tighten the drain hose to avoid separation.
- If the power cord is damaged or the hole of the socket outlet is loose, do not use the power cord and contact an authorized service centre.

Operation

- To avoid breaking the door glass, do not push too hard on the door when closing.
- Do not apply any sharp objects to the control panel in order to operate the appliance.
- Do not attempt to separate any panels or disassemble the appliance.
- Do not repair or replace any part of the appliance. All repairs and servicing must be performed by qualified service personnel unless specifically recommended in this Owner's Manual. Use only authorized factory parts.
- Do not push down the door excessively, when the appliance door is open.
- Do not put animals, such as pets into the appliance.

8 SAFETY INSTRUCTIONS

- Do not wash rugs, mats, shoes or pet blankets, stuffed toys, or any other items other than clothes or sheets, in this machine.
- Keep the area underneath and around the appliance free of combustible materials such as lint, paper, rags, chemicals, etc.
- Do not leave the appliance door open. Children may hang on the door or crawl inside the appliance, causing damage or injury.
- Do not put in, wash or dry articles that have been cleaned in, washed in, soaked in, or spotted with combustible or explosive substances (such as waxes, wax removers, oil, paint, gasoline, degreasers, drycleaning solvents, kerosene, petrol, spot removers, turpentine, vegetable oil, cooking oil, acetone, alcohol, etc.). Improper use can cause fire or explosion.
- Items such as foam rubber (latex foam), shower caps, waterproof textiles, rubber backed articles and clothes or pillows fitted with foam rubber pads should not be dried in the appliance.
- Do not use or store flammable or combustible substances (ether, benzene, alcohol, chemical, LPG, combustible spray, gasoline, thinner, petroleum, insecticide, air freshener, cosmetics, etc.) near the appliance.
- Never reach into the appliance while it is operating. Wait until the drum has completely stopped.
- Do not touch the door during a high temperature programme.
- In case of a water leak from the appliance or flood, disconnect the power plug and contact the LG Electronics customer information centre.
- Turn off water taps to relieve pressure on hoses and valves and to minimize leakage if a break or rupture should occur. Check the condition of the fill hoses; they should be replaced after 5 years.
- If there is a gas leakage (isobutane, propane, natural gas, etc.) within the home, do not touch the appliance or power plug and ventilate the area immediately.
- If the drain hose or inlet hose is frozen during winter, use it only after thawing.

- Keep all washing detergents, softener and bleach away from children.
- Do not touch the power plug or the appliance controls with wet hands.
- Do not bend the power cable excessively or place a heavy object on it.
- Avoid touching any water that is drained from the appliance during the wash.
- Make sure that drainage is working properly. If water is not drained properly, your floor may get flooded.
- When the air temperature is high and the water temperature is low, condensation may occur and thus wet the floor.
- Wipe off dirt or dust on the contacts of the power plug.

Maintenance

- Disconnect the appliance from the power supply before cleaning the appliance. Setting the controls to the OFF or stand by position does not disconnect this appliance from the power supply.
- Securely plug the power plug in the outlet socket after completely removing any moisture and dust.
- Do not spray water inside or outside the appliance to clean it.
- Never unplug the appliance by pulling on the power cable. Always grip the power plug firmly and pull straight out from the outlet socket.
- Only qualified service personnel from LG Electronics service centre should disassemble, repair, or modify the appliance. Contact an LG Electronics customer information centre if you move and install the appliance in a different location.

Disposal

- Before discarding an old appliance, unplug it. Cut off the cable directly behind the appliance to prevent misuse.

10 SAFETY INSTRUCTIONS

- Dispose of all packaging materials (such as plastic bags and styrofoam) away from children. The packaging materials can cause suffocation.
- Remove the door before disposing of or discarding this appliance to avoid the danger of children or small animals getting trapped inside.

CARING FOR THE ENVIRONMENT

Environmental and Economical Tips

Washer

Energy and water consumption

- Water consumption and energy usage can be affected by the weight of the load. To make the best use of your appliance, load the maximum amount of dry clothes for the particular programme.
- The most efficient programmes in terms of energy consumption are generally those that perform at lower temperatures and longer duration.
- Noise and remaining moisture content are influenced by the spinning speed: the higher the spinning speed in the spinning phase, the higher the noise and the lower the remaining moisture content.
- Evenly loading laundry up to the capacity indicated by the manufacturer for the respective programmes will contribute to energy and water savings.
- For washing smaller amounts of clothes, the automatic load recognition system will help reduce the amount of water and energy usage.
- Use the Speed programme for small, lightly soiled loads.
- Cold water laundry detergents can be as effective at lower temperatures (about 20 °C). Using 20 °C settings will use less energy than 30 °C or higher temperatures.

Detergent

- Detergent should be chosen according to type, colour, soiling of the fabric and the washing temperature. And it should be used according to the instruction of the detergent manufacturer. Use only detergents that are suitable for Drum (front load) type washers.
- Use less detergent on smaller loads.
 - Partial load: 1/2 of the normal amount.
 - Minimum load: 1/3 of full load.

Selecting Extra Options and Functions

- Select the water temperature suitable for the type of load you are washing. Follow the garment fabric care labels for best results.
- The Pre Wash option is recommended for washing a heavily soiled load.

Dryer

Energy consumption

- Spin clothes thoroughly before drying. If the clothes are wet or damp, drying time increase therefore the energy consumption increase.
- Load the clothes according to the recommended maximum capacity for each drying programme. Overloading is not economical due to the increase of energy consumption caused by the increase of drying time.
- The installation location should have adequate ventilation to avoid pulling in the air from nearby heat sourced appliances. Switch off the heat sourced appliances, if possible.
- Clean the lint filter before or after each load. Cleaning the lint filter will reduce drying time and energy consumption.

12 SAFETY INSTRUCTIONS

Disposal of Your Old Appliance



- This crossed-out wheeled bin symbol indicates that waste electrical and electronic products (WEEE) should be disposed of separately from the municipal waste stream.
- Old electrical products can contain hazardous substances so correct disposal of your old appliance will help prevent potential negative consequences for the environment and human health. Your old appliance may contain reusable parts that could be used to repair other products, and other valuable materials that can be recycled to conserve limited resources.
- You can take your appliance either to the shop where you purchased the product, or contact your local government waste office for details of your nearest authorised WEEE collection point. For the most up to date information for your country please see www.lg.com/global/recycling.

Disposal of the Packaging Material

- Dispose of the packaging waste according to recycling symbols of material types. Put the packaging waste in relevant containers to recycle it.

This dryer contains fluorinated greenhouse gases

R134a (GWP: 1430): 0.500 kg / 0.715 t CO₂-eq. Hermetically sealed.

INSTALLATION

Parts and Specifications

ENGLISH

NOTE

- Appearance and specifications may change without notice to improve the quality of the appliance.

Front View

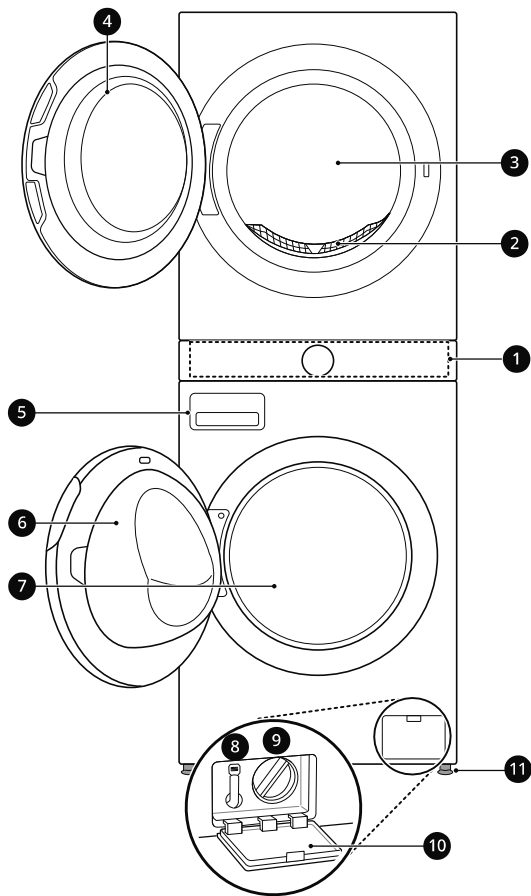

- 1 Control Panel
- 2 Lint Filter
- 3 Dryer Drum
- 4 Dryer Door
- 5 Detergent Dispenser Drawer
- 6 Washer Door
- 7 Washer Drum

- 8 Drain Hose
- 9 Drain Pump Filter
- 10 Drain Pump Filter Cover
- 11 Leveling Feet

Rear View

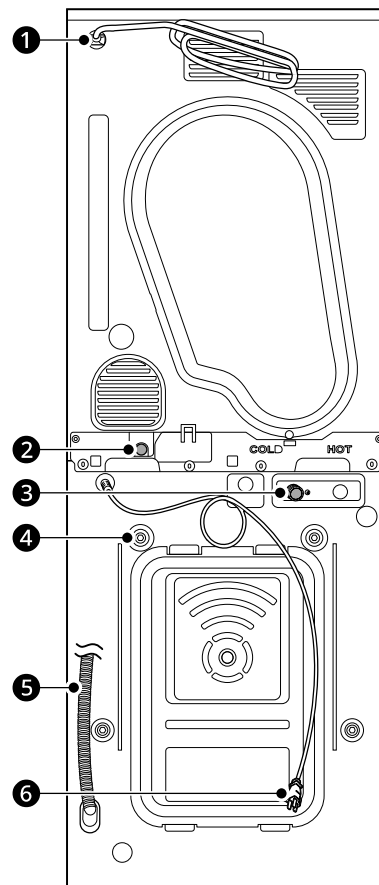

- 1 Power Cord (for Dryer)

14 INSTALLATION

- ② Drain Hole (for Dryer)
- ③ Cold Water Inlet (for Washer)
- ④ Transit Bolts
- ⑤ Drain Hose (for Washer)
- ⑥ Power Cord (for Washer)

Accessories

ENGLISH

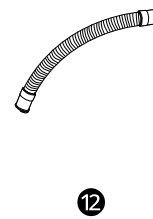
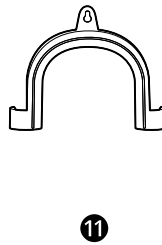
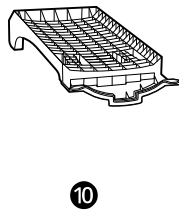
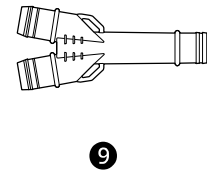
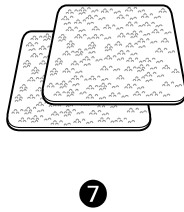
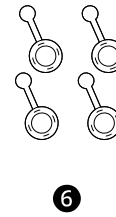
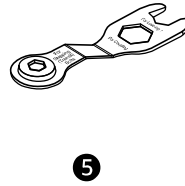
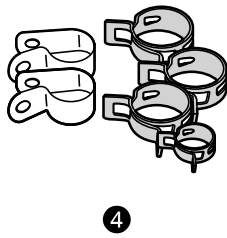
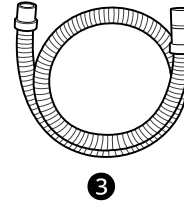
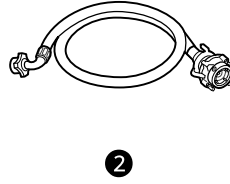
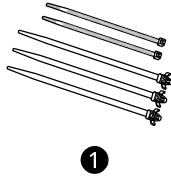

| | | | | | |
|----|-------------------|----|---|----|--------------------------------------|
| 1 | Cable Ties (5 EA) | 2 | Connecting Supply Hose (for Washer) | 3 | Water Drain Hose (for Dryer) |
| 4 | Band Clamps | 5 | Spanner | 6 | Caps for Covering Transit Bolt Holes |
| 7 | Anti-slip Sheets | 8 | Screws (2 EA) | 9 | Drain Hose Connector |
| 10 | Dry Rack*1 | 11 | Elbow Bracket for Securing Drain Hose*1 | 12 | Short Drain Hose |

*1 This accessory is only available on some models.

16 INSTALLATION

NOTE

- The images in this manual may be different from the actual components and accessories that are subject to change by the manufacturer without prior notice for product improvement purposes.
- The included accessories vary depending on the model you purchased.

Specifications

| Model | WT1210***** |
|------------------------------------|---|
| Power supply | 220- 240 V~, 50 Hz |
| Dimension (Width X Depth X Height) | 600 mm X 660 mm X 1655 mm |
| Product weight | 128kg |
| Maximum Power | 1900 - 2250 W (Wash) / 1000 W (Dry) |
| Permissible Inlet Water pressure | 50 kPa ~ 800 kPa (0.5~8.0 kgf/cm ²) |
| Allowable temperature | 5 - 35 °C |

Installation Place Requirements

Before installing the appliance, check the following information to make sure that the appliance should be installed in a correct place.

Installation Location

- This appliance must be installed on firm flooring to minimize vibration during the spin cycle. Concrete flooring is best, being far less prone to vibration during the spin cycle than wooden floorboards or a carpeted surface.
- If it is impossible to avoid positioning the appliance next to a gas cooker or coal burning stove, an insulation (850 X 600 mm) covered with aluminum foil on the side facing the cooker or stove must be inserted between the two appliances.
- Ensure that when the appliance is installed, it is easily accessible for an engineer in the event of a breakdown.
- When installing the appliance, adjust all four feet using the transit bolt spanner provided to ensure the appliance is stable.

Floor Installation

*1 minimum space for installation

To ensure sufficient clearance for water inlet hoses, drain hose and airflow, allow minimum clearances on the sides and behind the appliance. Be sure to allow for wall, door, or floor moldings that may increase the required clearances.

The tap is to the REAR when the appliance is placed.

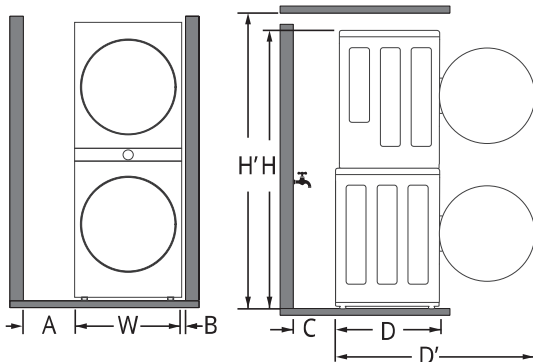

| | |
|----|----------------------|
| A | 30 cm ^{*1} |
| W | 60 cm |
| B | 5 cm |
| C | 20 cm |
| D | 66 cm |
| D' | 118 cm ^{*1} |
| H | 166 cm |
| H' | 177 cm |

The tap is to the SIDE when the appliance is placed.

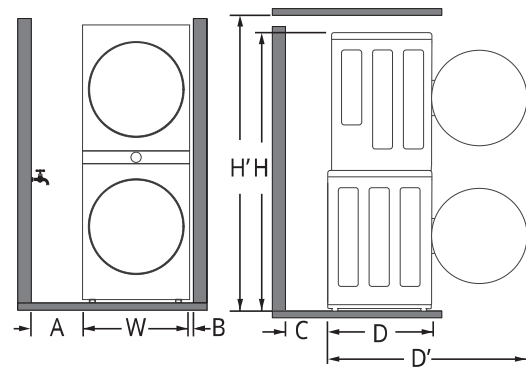

| | |
|----|----------------------|
| A | 15 cm ^{*1} |
| W | 60 cm |
| B | 5 cm |
| C | 10 cm |
| D | 66 cm |
| D' | 118 cm ^{*1} |
| H | 166 cm |
| H' | 177 cm |

⚠ WARNING

- This appliance must only be used for domestic household purposes and should not be used in mobile applications.

18 INSTALLATION

NOTE

- Never try to level any uneven floor by putting pieces of wood, cardboard or similar materials under the appliance.

Ventilation

Alcove or under counter

Make sure that air circulation around the appliance should not be impeded by carpets, rugs, etc.

Cupboard

Cupboard door must have 2 (louvered) openings, each having a minimum area of 387 cm², located 8 cm from the bottom and top of the door.

Ambient Temperature

- Do not install the appliance in rooms where freezing temperatures may occur. Frozen hoses may burst under pressure. The reliability of the electronic control unit may be impaired at temperatures below freezing point.

NOTE

- If the appliance is delivered in winter and temperatures are below freezing, place the appliance at room temperature for a few hours before putting it into operation.
- The appliance performs best at a room temperature of 23 °C.

Wooden Floors (Suspended Floors)

When installing the appliance on wooden floors, use rubber cups to reduce excessive vibration and unbalance. Timber or suspended type flooring may

contribute to excessive vibration and unbalance, errors and malfunction.

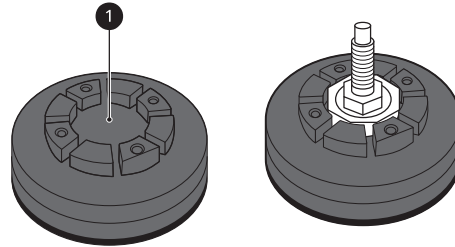

- To reduce vibration, we recommend placing at least 20 mm thickness of rubber caps **1** under each adjusting foot of the appliance, secured to at least two floor beams with screws.
- If possible, install the appliance in one of the corners of the room, where the floor is more stable.
- Fit the rubber cups to reduce vibration.

CAUTION

- If the appliance is installed on the unstable floor (e.g. wooden floor), the warranty does not cover any damages and cost occurred due to the installation on the unstable floor.

NOTE

- You can purchase rubber cups (part No. **MJB65174401, MJB65174501**) from the LG service centre.

Electrical Connection

- Do not use an extension cord or double adapter.
- Always unplug the appliance and turn off the water supply after use.
- Connect the appliance to an earthed socket in accordance with current wiring regulations.
- The appliance must be positioned so that the plug is easily accessible.
- Power outlet must be within 1 meter of either side of the appliance.

⚠ WARNING

- Repairs to the appliance must only be carried out by qualified personnel. Repairs carried out by inexperienced persons may cause injury or serious malfunctioning. Contact your local authorised LG repairer.
- The power plug must be plugged into an appropriate outlet socket that is installed and grounded/earthed in accordance with all local codes and ordinances.

After removing the carton and shipping material, lift the appliance off the foam base.

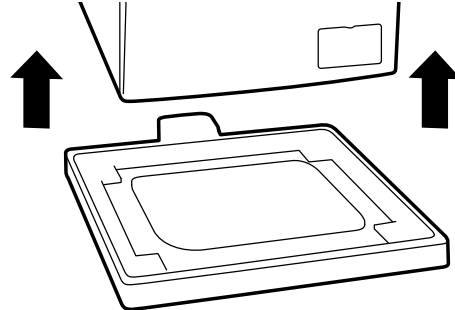

ENGLISH

Unpacking the Appliance

⚠ WARNING

- When installing this appliance, take adequate measures to protect yourself, e.g. by wearing protective gloves.
- Moving or installation of the appliance requires two or more people. Failure to follow these instructions may result in injury.
- When moving the product, tilt it toward the back of the product. Do not transport the product in a horizontal position.

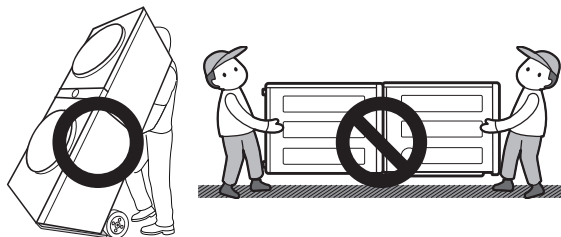

Removing the Transit Bolt Assemblies

To prevent the appliance from severe vibration and breakage, remove transit bolts and retainers.

- 1 Starting with the bottom two transit bolts ①, use the spanner (included) to fully loosen all transit bolts by turning them counterclockwise.

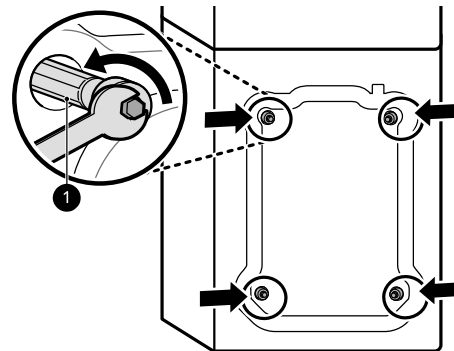

- 2 Remove the bolt assemblies by wiggling them slightly while pulling them out.

- 3 Install the hole caps.

Lifting the Appliance Off the Foam Base

* This feature may vary depending on the model purchased.

20 INSTALLATION

- Locate the hole caps **2** included in the accessory pack or attached on the back.

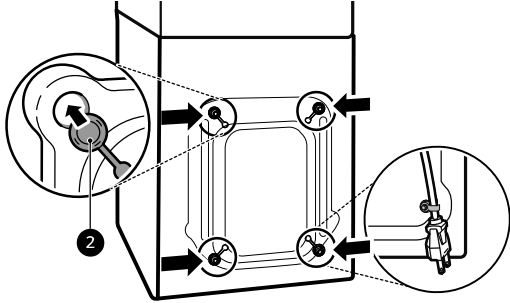

NOTE

- Save the transit bolts and retainers for future use.
- To prevent damage to the appliance during transport:
 - Reinstall the transit bolts.
 - Secure the power cord to the back of the appliance.

Connecting the Water Supply Hose

Note for Connection

- Water pressure must be between **50 kPa** and **800 kPa** (0.5 – 8.0 kgf/cm²). If the water pressure is more than **800 kPa**, a decompression device should be installed.
- Periodically check the condition of the water supply hose and replace the water supply hose if necessary.

NOTE

- Do not overtighten the water supply hose or use mechanical devices to tighten onto the inlet valves.
- No further backflow protection required for connection to the water inlet.

Checking the Rubber Seal

Two rubber seals **1** are supplied with the water supply hose. They are used for preventing water leaks. Connection to taps is sufficiently tight.

- Do not use mechanical devices such as multi grips to tighten the water supply hose. Ensure that the curved end of the water supply hose is connected to the appliance.

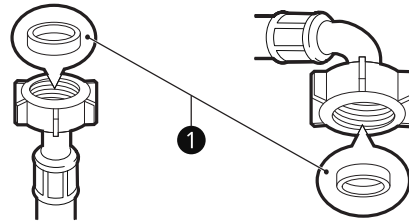

Connecting the Hose to the Water Tap

Connecting Screw-Type Hose to Tap with Thread

Screw the supply hose connector onto the water supply tap.

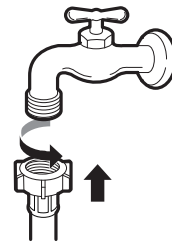

Connecting Screw-Type Hose to Tap Without Thread

- 1 Loosen the 4 fixing screws **1**.

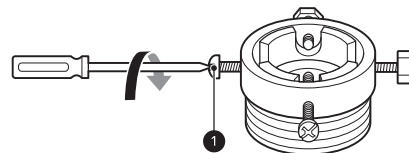

- 2 Remove the guide plate ② if the tap is too large to fit the adapter.

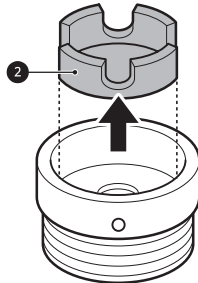

- 2 Remove the guide plate ⑤ if the tap is too large to fit the adapter.

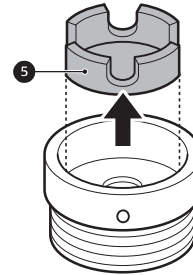

- 3 Push the adapter onto the end of the tap so that the rubber seal is connected to be watertight. Tighten the 4 fixing screws.

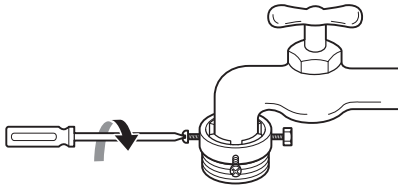

- 3 Push the adapter onto the end of the tap so that the rubber seal is connected to be watertight. Tighten the 4 fixing screws and the adapter ring plate.

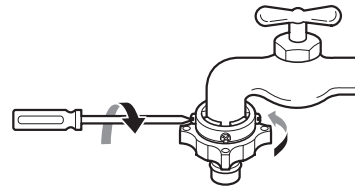

- 4 Push the inlet hose ③ vertically upwards so that the rubber seal within the hose can adhere completely to the tap and then tighten the hose by screwing it to the right.

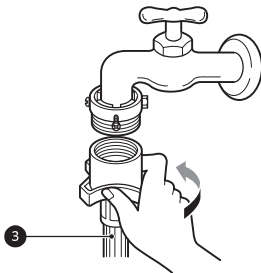

- 4 Pull the connector latch plate ⑥ down, push the inlet hose onto the adapter, and release the connector latch plate. Make sure the adapter locks into place.

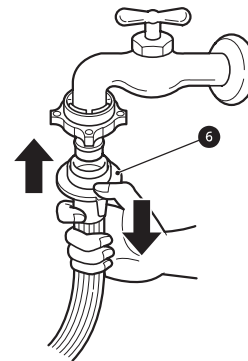

Connecting One Touch Type Hose to Tap Without Thread

- 1 Unscrew the adapter ring plate ④ and loose the 4 fixing screws.

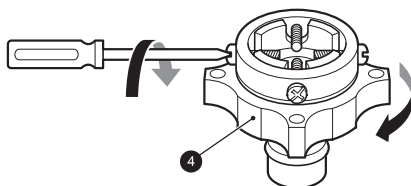

NOTE

- After connecting the water inlet hose to the water tap, turn on the water tap to flush out foreign substances (dirt, sand, sawdust, and etc.) in the water lines. Let the water drain into a bucket, and check the water temperature.

22 INSTALLATION

Connecting the Hose to the Appliance

- 1 Screw the supply hose to the water inlet valve on the back of the appliance.

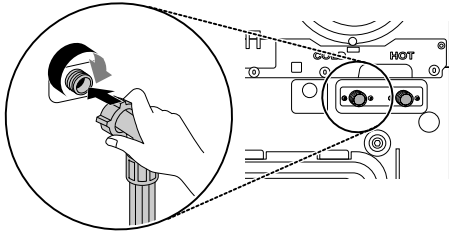

NOTE

- Do not connect the hose to the hot water supply for models with one water inlet. Connect to the cold water supply only.
- After completing connection, if water leaks from the hose, repeat the same steps. Use the most conventional type of tap for the water supply. In case that the tap is square or too big, remove the guide plate before inserting the tap into the adaptor.
- Make sure that the hose should not be kinked or trapped.

- 2 Connect the drain hose of the dryer and secure the hose clamp.

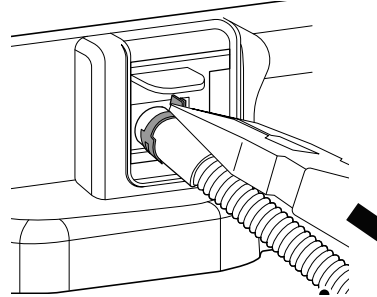

- 3 Screw in the band to secure the drain hose of the dryer onto the stacking bracket.

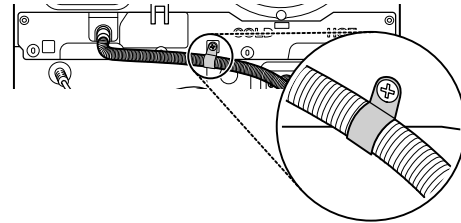

- 4 Use the provided tie strap ② to secure the 2 drain hoses in place.

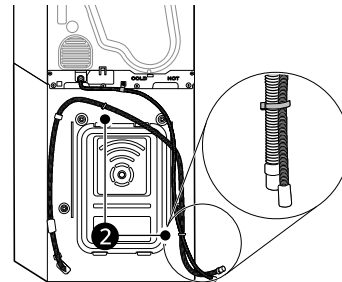

Installing the Drain Hose

Connecting the Drain Hose to the Dryer

- 1 Insert the hose clamp ① onto the drain hose of the dryer.

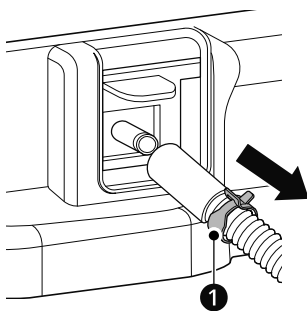

NOTE

- The drain hose should not be placed higher than **80 cm** above the floor. Water in the appliance may not drain or may drain slowly.
- Securing the drain hose correctly will protect the floor from damage due to water leakage.
- If the drain hose is too long, do not force it back into the appliance. This will cause abnormal noise.

- If the drain hose is installed in a way that leaves it bent or pinched, drainage may not function properly.

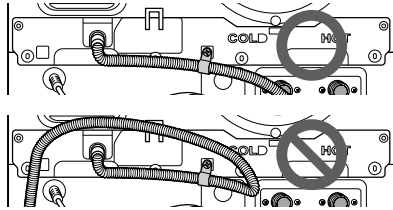

- Depending on the installation environment, you may have to purchase a separate drain hose connector. The connector supplied will suit a standard laundry tub side drain hole.
- Use the elbow bracket **1** and the drain hose connector **2** if necessary. When installing the drain hose to a sink, secure it tightly with string.

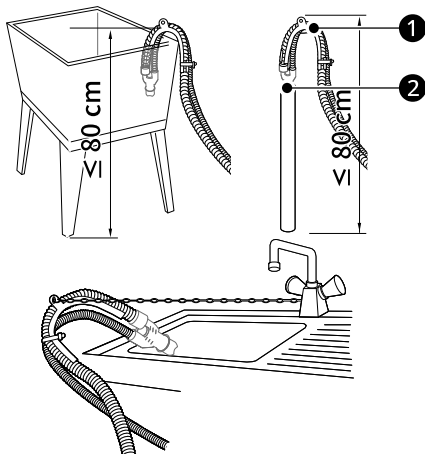

band clamp **1** to keep the washer hose in place.

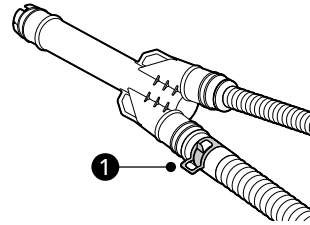

- Use the band clamp **2** on the short drain hose to attach it to the bottom opening of the drain hose connector.

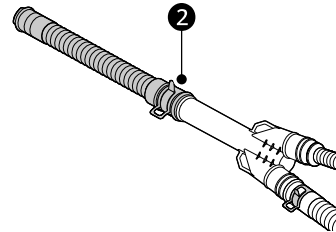

- Securely connect the short drain hose to a drain spigot, into a standpipe or laundry sink bypass pipe. When connecting to a waste spigot, use the band clamp **3** to the end of the short drain hose.

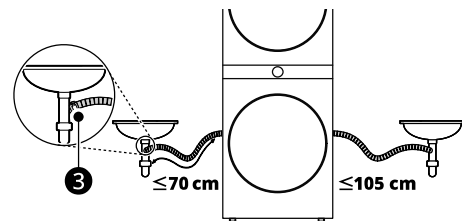

Connecting Hoses to the Drain Hose Connector (Optional)

Additionally follow the steps below to connect the drain hose using drain hose connector if the above installation is not sufficient.

- Slide the included band clamp onto the end of the drain hose of the washer.
- Connect the drain hoses from the washer and dryer to the drain hose connector. Tighten the

⚠ CAUTION

- Adjust the wire hose clamp to prevent the hose from coming loose or leaking. Failure to do so could result in flooding. Use of the drain hose connector helps avoid siphoning, odours, or improper draining.
- Make sure the drain hoses are not kinked or pinched. This is a potential cause of drainage problems or noise.

24 INSTALLATION

Levelling the Appliance

Checking the Level

When pushing down the edges of the top plate diagonally, the appliance should not move up and down at all (check both directions).

- If the appliance rocks when pushing the top plate of the appliance diagonally, adjust the feet again.
- Check whether the appliance is perfectly level after installation.

NOTE

- Timber or suspended type flooring may contribute to excessive vibration and unbalance. Reinforcement or bracing of the timber floor may need to be considered to stop or reduce excessive noise and vibration.

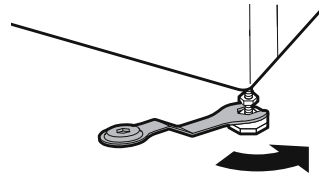

NOTE

- Do not install the washing machine on a plinth, stand or elevated surface unless it is manufactured by LG Electronics for use with this model.

- 2 Check if the appliance is perfectly level using a spirit level ①.

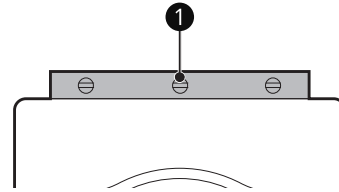

Adjusting and Levelling the Feet

When installing the appliance, the appliance should be aligned and perfectly level. If the appliance is not aligned and level properly, the appliance may be damaged or may not operate properly.

- 1 Turn the levelling feet as required if the floor is uneven.
 - Do not insert pieces of wood etc. under the feet.
 - Make sure that all four feet are stable and resting on the floor.

- 3 Secure the levelling feet with the lock nuts ② by turning anti-clockwise against the bottom of the appliance.

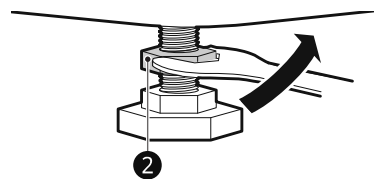

- 4 Check if all lock nuts at the bottom of the appliance are secured properly.

NOTE

- Proper placement and levelling of the appliance will ensure long, regular, and reliable operation.
- The appliance must be 100% horizontal and stand firmly in position on a hard flat floor.

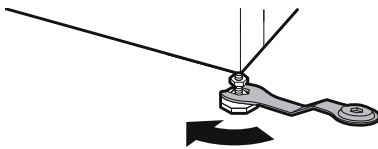

- It must not 'Seesaw' across corners under the load.
- Do not let the feet of the appliance get wet. Failure to do so may cause vibration or noise.

NOTE

- Additional anti-slip sheets are available at LG Electronics service centre.

ENGLISH

Using Anti-Slip Sheets

This feature may vary depending on the model purchased.

If you install the appliance on a slippery surface, it may move because of excessive vibration.

Incorrect levelling may cause malfunction through noise and vibration. If this occurs, install the anti-slip sheets under the levelling feet and adjust the level.

- 1** Clean the floor to attach the anti-slip sheets.
 - Use a dry rag to remove and clean foreign objects and moisture. If moisture remains, the anti-slip sheets may slip.
- 2** Adjust the level after placing the appliance in the installation area.
- 3** Place the adhesive side **1** of the anti-slip sheets on the floor.
 - The most effective way is to install the anti-slip sheets under the front feet. If it is difficult to place the sheets under the front feet of the appliance, attach them under the rear feet.

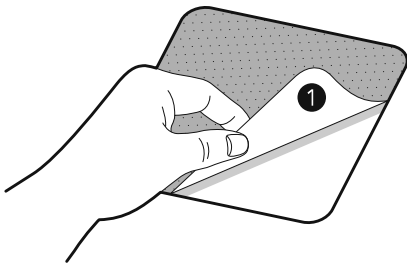

- 4** Put the appliance on the anti-slip sheets.
 - Do not attach the adhesive side **1** of anti-slip sheets to the feet of the appliance.

26 OPERATION-WASHER

OPERATION-WASHER

Operation Overview

Using the Washer

Before the first wash, select the **Cotton** wash programme and add a half amount of the detergent. Start the appliance without clothes. This will remove possible residues and water from the drum that may have been left during manufacturing.

- 1 Sort clothes by fabric type, soil level, colour and load size as needed.
- 2 Open the door and load items into the appliance.

⚠ CAUTION

- Before closing the door, ensure that all clothes and items are inside the tub and not overhanging on the rubber door seal where they will become caught when the door is closed. Failing to do so will cause damage to the door seal and the clothes.

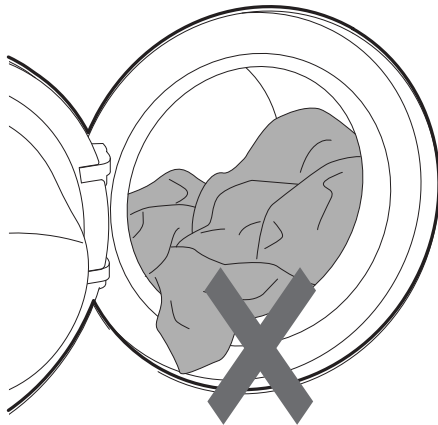

- 3 Close the door.

⚠ CAUTION

- Remove items from the flexible door seal gasket to prevent clothing and door seal damage.

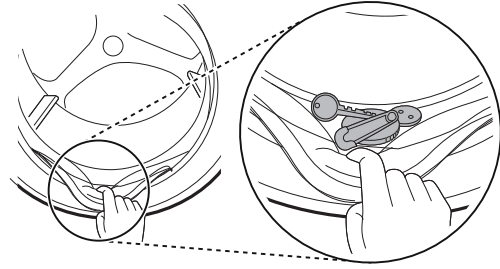

- 4 Add cleaning products or detergent and softener.
 - Add the proper amount of detergent to the detergent dispenser. If desired, add bleach or fabric softener to the appropriate areas of the dispenser.
- 5 Press the **Power** button to turn on the appliance.
- 6 Choose the desired cycle.
 - Press the cycle button repeatedly until the desired cycle is selected.
 - Now select a wash temperature and spin speed. Pay attention to the fabric care label of your clothes.
- 7 Begin cycle.
 - Press the **Start/Pause** button to begin the cycle. The appliance will agitate briefly without water to measure the weight of the load. If the **Start/Pause** button is not pressed within a certain time, the appliance will shut off and all settings will be lost.
- 8 End of cycle.

- When the cycle is finished, a melody will sound. Immediately remove your clothing from the appliance to reduce wrinkling.

Preparing the Wash Load

Sorting the Clothes

- For best washing results, sort your clothes according to the care label stating fabric type and washing temperature. Adjust the spin speed or spin intensity in accordance to the fabric type.
- Soil level (Heavy, Normal, Light): Separate clothes according to soil level. If possible, do not wash heavily soiled items with lightly soiled ones.
- Colour (White, Lights, Darks): Wash dark or dyed clothes separately from whites or light colours. Mixing dyed clothes with light clothes can result in dye transfer or discolouration of lighter clothes.
- Lint (Lint producers, Collectors): Wash separately lint producing fabrics from lint collecting fabrics. Lint producers can result in pilling and linting on the lint collectors.

Checking the Clothes Care Label

The symbols tell you about the fabric content of your garment and how it should be washed.

Symbols on the Care Labels

| Symbol | Wash / Fabric type |
|--------|---|
| | <ul style="list-style-type: none"> • Normal Wash • Cotton, Mixed Fabrics |
| | <ul style="list-style-type: none"> • Easy Care • Synthetic, Mixed Fabrics |
| | <ul style="list-style-type: none"> • Special Delicate Wash • Delicates |
| | <ul style="list-style-type: none"> • Hand Wash Only • Wool, Silk |

| Symbol | Wash / Fabric type |
|--------|---|
| | <ul style="list-style-type: none"> • Do not wash |

NOTE

- The dashes under the symbol give you information about the type of fabric and the maximum allowance of mechanical stress.

Checking the Clothes before Loading

- Combine large and small items in a load. Load large items first.
- Large items should not be more than half of the total wash load. Do not wash single items. This may cause an unbalanced load. Add one or two similar items.
- Check all pockets to make sure that they are empty. Items such as nails, hair clips, matches, pens, coins and keys can damage both your appliance and clothes.

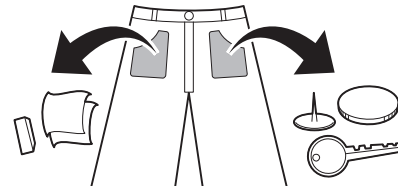

- Wash delicates (stockings, underwired bras) in a wash net.
- Close zippers, hooks and strings to make sure that these items do not snag on other clothes.
- Pre-treat dirt and stains by brushing a small amount of detergent dissolved water onto stains to help lift dirt.

28 OPERATION-WASHER

Adding Detergents and Softeners

Detergent Dosage

- Detergent should be used according to the instruction of the detergent manufacturer and selected according to type, colour, soiling of the fabric and the washing temperature. Use only detergents that are suitable for Drum (front load) type washers.
- If too many suds occur, reduce the detergent amount.
- If too much detergent is used, too many suds can occur and this will result in poor washing results or cause heavy load to the motor.
- If you wish to use liquid detergent, follow the guidelines provided by the detergent manufacturer.
- You can pour liquid detergent directly into the main detergent drawer if you are starting the wash cycle immediately.
- Do not use liquid detergent if you have selected **Pre Wash** option, as the liquid will dispense immediately and may harden in the drawer or the tub.
- Detergent usage may need to be adjusted for water temperature, water hardness, size and soil level of the load. For best results, avoid overdosing the detergent. Failing to do so will cause oversudsing.
- Refer to the label of the clothes, before adding the detergent and choosing the water temperature.
- Use only suitable detergents for the respective type of clothing:
 - Liquid detergent is often designed for special applications, e.g. for coloured fabric, wool, delicate or dark clothes.
 - Powdered detergent is suitable for all types of fabric.
 - For better washing results of white and pale garments, use powdered detergent with bleach.
 - Detergent is flushed from the dispenser at the beginning of the wash cycle.

NOTE

- Do not let the detergent harden. Doing so may lead to blockages, poor rinse performance or odour.
- Full load: According to manufacturer's recommendation.
- Part load: 1/2 of the normal amount.
- Minimum load: 1/3 of full load.

Using the Dispenser

To add detergent dosage to the dispenser:

- 1 Open the dispenser drawer.
- 2 Add the detergent and softener into the appropriate compartments.

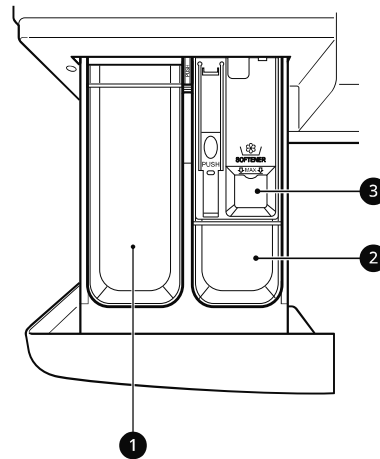

- 1 Main wash detergent compartment
- 2 Pre-wash detergent compartment
- 3 Liquid fabric softener compartment

- 3 Gently close the detergent dispenser drawer before starting the cycle.
 - Slamming the drawer closed may result in the detergent overflowing into another compartment or dispensing into the drum earlier than programmed.

- Be careful not to get a hand caught in the drawer while closing.
- It is normal for a small amount of water to remain in the dispenser compartments at the end of the cycle.

Fabric Softener Compartment

This compartment holds liquid fabric softener, which is automatically dispensed during the final rinse cycle. Either powdered or liquid fabric softener may be used.

- Pour fabric softer to the maximum fill line. Pouring excessive fabric softener over the maximum fill line can cause it to dispense too early, which may stain the clothes.

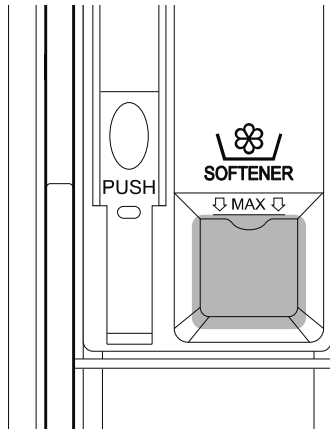

NOTE

- Do not pour fabric softener directly onto the clothes in the wash drum, doing so will cause dark staining on the clothes that will be difficult to remove.
- Do not leave the fabric softener in the detergent drawer for more than 1 day. Fabric softener may harden. Softener may remain in the dispenser if it is too thick. The softener should be diluted if the consistency is too thick so that it can flow easily.
- Do not open the drawer when water is being supplied during the wash.
- Solvents (benzene, etc.) must never be used.

Adding Water Softener

A water softener, such as anti-limescale can be used to cut down on the use of detergent in areas with high water hardness level.

- First add detergent, and then the water softener. Dispense according to the amount specified on the packaging.

Adding Detergent Tablets

Detergent tablets can also be used when washing.

- 1 Open the door and put detergent tablets into the drum before loading the clothes.
- 2 Load the clothes into the drum and close the door.

NOTE

- Do not put tablets into the dispenser.

30 OPERATION-WASHER

Control Panel and Programme Table

Control Panel Features

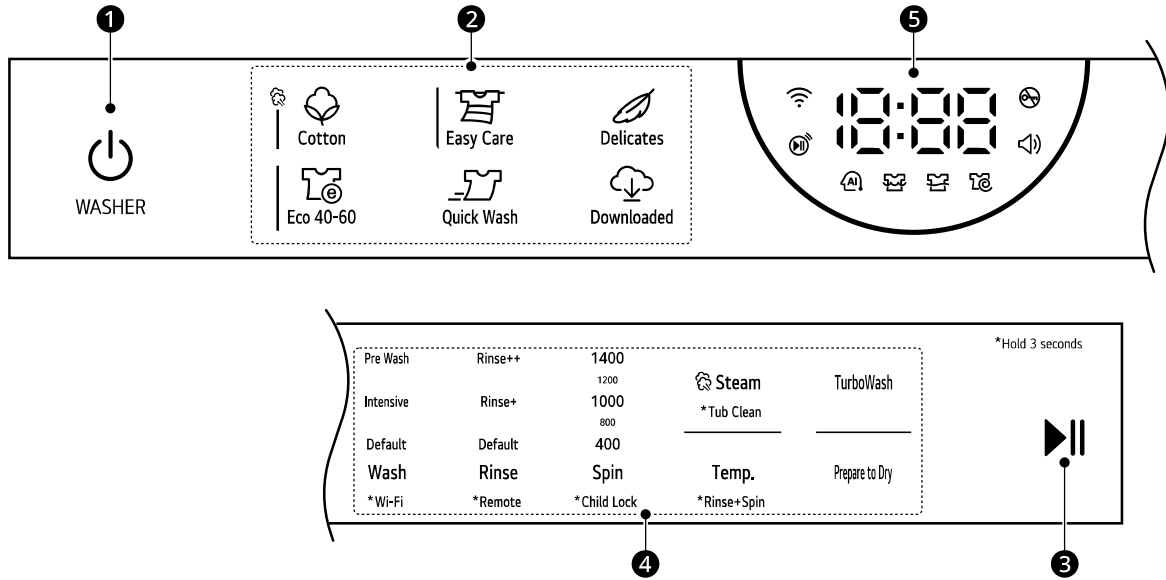

| | Description |
|---|--|
| ① | <p>Power On/Off Button</p> <ul style="list-style-type: none"> Press the button to turn the appliance on. Hold again to turn the appliance off. Pressing the Power button during a programme will cancel that programme and any load settings will be lost. |
| ② | <p>Programme Buttons</p> <ul style="list-style-type: none"> Programmes are available according to the clothes type. The lamp will light up to indicate the selected programme. |
| ③ | <p>Start/Pause Button</p> <ul style="list-style-type: none"> This button is used to start the wash programme or pause the wash programme. If a temporary stop of the wash programme is needed, press this button. |

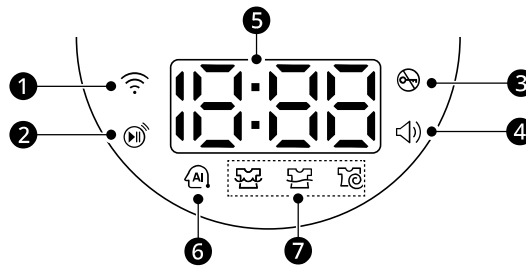

| | Description |
|---|---|
| ④ | <p>Customizing Washing Programme Buttons / Extra Options and Functions</p> <ul style="list-style-type: none"> Use these buttons to select the desired options for the selected programme. Not all options are available in each programme. To use the extra functions, press and hold the corresponding button for 3 seconds. The corresponding symbol lights up in the display. <p>Remote With the LG ThinQ app, you can use a smartphone to control your appliance remotely.</p> <ul style="list-style-type: none"> In order to use this function, refer to SMART FUNCTIONS. <p>Wi-Fi Press and hold the Wash button for 3 seconds to initiate the connection of the appliance to the LG ThinQ application.</p> |
| ⑤ | <p>Time and Status Display</p> <ul style="list-style-type: none"> The display shows the settings, estimated remaining time, options, and status messages. When the appliance is turned on, the default settings in the display will illuminate. While the load weight is sensed automatically, the display on the control panel blinks. |

Time and Status Display



| | Description |
|---|---|
| ① | Wi-Fi symbol lights up when the appliance is connected to Wi-Fi network at home. |
| ② | Speaker symbol lights up when the remote control feature is activated. |
| ③ | Lock symbol lights up when the programme starts and the door is locked. |
| ④ | Beeper symbol lights up when the beep is on. Beep sound can be turned on or off only through the LG ThinQ application. |

32 OPERATION-WASHER

| | Description |
|---|---|
| 5 | <p>Estimated Time Remaining</p> <ul style="list-style-type: none"> When a washing programme is selected, the default time for that programme is displayed. This time will change as options are selected. If the display shows --- , then the time will be displayed after the load sensing has detected the load size. This is normal. The time shown is only an estimate. This time is based on normal operating conditions. Several external factors (load weight, room temperature, incoming water temperature, etc.) can affect the actual time. |
| 6 | <p>AI DD</p> <ul style="list-style-type: none"> AI DD  provides the appropriate drum rotation actions after load sensing is completed.  is activated when the Cotton and Easy Care programmes are selected and operated. |
| 7 | <p>Programme Status Indicators</p> <ul style="list-style-type: none"> When a washing programme is running, LED for the active stage will blink, and the LEDs for the remaining stages will remain steady. Once a stage is complete, the LED will turn off. If a cycle is paused, the active stage LED will stop blinking. |

Washing Programme

| | | |
|--------------------|---|--------------------------|
| Cotton | 40 °C (Cold to 95 °C) | Max. Load: Rating |
| Description | Washes normally soiled clothes by combining various drum motions. <ul style="list-style-type: none"> Pressing the Start/Pause button without selecting a programme will cause the Cotton programme to begin immediately, using the default settings. | |
| Easy Care | 40 °C (Cold to 60 °C) | Max Load: 2.5 kg |
| Description | Washes clothes that do not need ironing after washing. <ul style="list-style-type: none"> Use for Polyamide, acrylic, polyester. | |
| Delicates | 20 °C (Cold to 40 °C) | Max. Load: 3 kg |
| Description | Washes hand-washable and machine-washable delicate clothes such as washable wool, lingerie, dresses etc. | |
| Eco 40-60 | 40 °C (40 °C to 60 °C) | Max. Load: Rating |
| Description | Washes normally soiled cotton clothes declared to be washable at 40 °C or 60 °C. | |

| | | |
|--------------------|---|------------------------|
| Quick Wash | 20 °C (20 °C to 40 °C) | Max. Load: 1 kg |
| Description | Washes small loads of lightly soiled clothes in a short time. | |
| Downloaded | 60 °C | - |
| Description | This programme allows you to download a new and special washing programme to your appliance with a smartphone. The default programme is Allergy Care . | |

NOTE

- Select the appropriate water temperature for chosen wash programme. Always follow garment manufacturer’s care label or instructions when washing to avoid damage to clothes.
- Select the proper wash temperature and spin speed for the desired programmes.
- Actual water temperature may differ from the declared cycle temperature.
- Neutral detergent is recommended.

Extra Options

| Programme | TurboWash | Steam |
|-------------------|-----------|-------|
| Cotton | ● | ● |
| Easy Care | ● | ● |
| Delicates | ● | |
| Eco 40-60 | ● | ● |
| Quick Wash | ●*1 | |

*1 This option is automatically included in the programme.

Selectable Spin Speed

| Programme | Spin Speed | |
|-------------------|------------|---------------|
| | Default | Available |
| Cotton | 1400 rpm | All |
| Quick Wash | 400 rpm | All |
| Delicates | 800 rpm | Up to 800 rpm |

34 OPERATION-WASHER

| Programme | Spin Speed | |
|------------------|------------|-----------|
| | Default | Available |
| Eco 40-60 | 1400 rpm | All |
| Easy Care | 1400 rpm | All |

NOTE

- Actual maximum spin speed may vary depending on the load conditions. The values above are rounded to the nearest hundred.

Consumption Data

Unit Description

kg: Laundry load

h:mm: Programme duration

kWh: Energy consumption

°C: Maximum temperature inside the treated textile

Litres: Water consumption

rpm: Maximum spin speed

%: Remaining moisture at the end of spinning phase. The higher is the spin speed, the higher is the noise and the lower is the remaining moisture.

Common Programmes

| Programme | kg | h:mm | kWh | °C | Litres | rpm | % |
|---|----|------|-------|----|--------|------|-------|
| Cotton 20 °C | 12 | 2:05 | 0.211 | 27 | 77.1 | 1350 | 50.0 |
| Cotton 40 °C + Intensive | 12 | 2:59 | 0.546 | 29 | 75.0 | 1350 | 52.3 |
| Cotton 60 °C | 12 | 3:43 | 1.441 | 46 | 76.5 | 1350 | 50.4 |
| Easy Care | 5 | 2:48 | 1.232 | 40 | 74.4 | 1350 | 51.9 |
| Quick Wash | 1 | 0:14 | 0.049 | 21 | 31.7 | 400 | 110.2 |
| Eco 40-60 (Full)^{*1} | 12 | 4:00 | 0.850 | 30 | 94.0 | 1350 | 45.0 |
| Eco 40-60 (Half)^{*1} | 6 | 3:00 | 0.550 | 28 | 54.0 | 1350 | 45.5 |
| Eco 40-60 (Quarter)^{*1} | 3 | 2:40 | 0.320 | 25 | 43.0 | 1350 | 44.6 |

*1 It is able to clean normally soiled cotton laundry declared to be washable at 40 °C or 60 °C, together in the same cycle, and that this programme is used to assess the compliance with the EU ecodesign legislation (EU 2019/2023).

NOTE

- The test results depend on water pressure, water hardness, water inlet temperature, room temperature, type and amount of load, degree of soiling utilized detergent, fluctuations in the main electricity supply and chosen additional options.
- The values for the common programs, with the exception of the **Eco 40-60** cycle, are indicative only.
- Regulation EU 2019/2023, valid from 1st March 2021, is related to the Energy Efficiency classes by Regulation EU 2019/2014.
- Scan the QR code on the energy label supplied with the appliance, which provides a web link to the information related to the performance of the appliance in the EU EPREL database. Keep the energy label for reference together with the owner's manual and all other documents supplied with the appliance.
- The model name can be found on the rating label of the appliance, open the door which is just around the opening to the drum.
- To find the same information in EPREL, visit <https://eprel.ec.europa.eu> and search using the model name.

36 OPERATION-WASHER

Extra Options and Functions

Customizing a Washing Programme

Each programme has default settings that are selected automatically. You may also customize these settings using these buttons.

Wash

Press the **Wash** button repeatedly until the desired soil level is selected.

- **Pre Wash:** for heavily soiled clothes
- **Intensive:** for normal and heavily soiled clothes
- **Default:** for normal soiled clothes

NOTE

- Selectable options will differ depending on the selected programme.

Rinse

The number of rinses can be selected by pressing the **Rinse** button. This function is recommended for people with detergent allergies.

Spin

The spin intensity level can be selected by pressing this button repeatedly.

Press the **Spin** button to select spin speed.

Temp.

This button selects the wash temperature for the selected programme.

Press the **Temp.** button until the desired setting is lit.

- Select the water temperature suitable for the type of load you are washing. Follow the garment fabric care labels for best results.

Follow the next steps to customize a washing programme:

- 1 Prepare the clothes and load the drum.
- 2 Press the **Power** button.

3 Add detergent.

4 Select a washing programme.

5 Customize the washing programme (**Wash, Rinse, Spin,** and **Temp.**) as necessary.

6 Press the **Start/Pause** button.

Only Using a Spin Function

1 Prepare the clothes and load the drum.

2 Press the **Power** button.

- Do not select a washing programme and do not add a detergent.

3 Press the **Spin** button.

4 Press the **Start/Pause** button.

NOTE

- If you select the washing programme, you will be unable to select a spin only. If this occurs, press **Power** button twice to cycle the machine off and back on.

Using Special Options

You can customize the programmes by using the following special options:

Steam

Adding this option helps provide better cleaning results.

TurboWash

Adding this option reduces the programme time but the similar washing results will be provided.

Follow the next steps to use a special option.

- 1 Press the **Power** button.
- 2 Select a washing programme.
- 3 Change the washing programme (**Temp.**, **Rinse** or **Spin**) as necessary.
- 4 Press the **Steam** or **TurboWash** button.
- 5 Press the **Start/Pause** button.

Prepare to Dry

Setting this function allows the the dryer to operate automatically after the washing programme.

Follow the next steps to use a special option.

- 1 Press the **Power** button of the washer.
- 2 Select a washing programme.
- 3 Change the washing programme (**Temp.**, **Rinse** or **Spin**) if necessary.
- 4 Press the **Prepare to Dry** button of the washer.
- 5 Press the **Start/Pause** button of the washer.
 - When the dryer is turned, the paired drying programme and option will be displayed.
 - After the load weight is sensed, the dryer display shows the estimated remaining dry time for about 1 minute.

While the **Prepare to Dry** is in operation, the dryer display shows Pr-E.

- 6 After the washing programme is finished, load items into the dryer and close the door.

- 7 Press the **Start/Pause** button of the dryer.
 - The dryer display shows the estimated remaining dry time.

NOTE

- the **Prepare to Dry** function will not be activated in the following cases:
 - If you don't start the dryer within 15 minutes after the washing programme has finished
 - If the dryer is unplugged
 - If the remote control function is used
 - If the washer or dryer is shut down while setting the **Prepare to Dry** function
- When the option is set, *only* the **Power** button works and lock the door. Open the door of the dryer after the washing programme has finished.

Using Basic Options

You can customize the programmes by using the following basic options:

Rinse+Spin

It allows you to rinse and spin a load separately from a regular programme. It is helpful in preventing fresh stains from setting in fabrics.

- 1 Press the **Power** button.
- 2 Select a washing programme.
- 3 Press and hold the **Temp.** button for 3 seconds as necessary.
 - You can change the spin speed by pressing the **Spin** button.
- 4 Press the **Start/Pause** button.

38 OPERATION-WASHER

Settings

Child Lock

Use this option to disable the controls. This function can prevent children from changing cycles or operating the appliance.

NOTE

- Once this function is set, all buttons are **locked** except the **Power** button.
- When the controls are locked, **CL** and the remaining time are **alternatively** shown on the display during the wash while this function is engaged.
- Turning off the power will not reset this function. You must deactivate this function before you can access any other functions.

Locking the Control Panel

- 1 Turn on the power.
- 2 Press and hold the **Spin** button for 3 seconds to activate this function.
 - A beeper will sound, and **CL** will appear on the display.

Unlocking the Control Panel

- 1 Turn on the power.
- 2 Press and hold the **Spin** button for 3 seconds to deactivate this function.

OPERATION-DRYER

Operation Overview

Using the Dryer

Before the first cycle, set the appliance to dry for 5 minutes to warm up the drum. Open the door between loads the first few times you use the appliance to allow any odours from the interior of the appliance to disperse.

Children must be supervised so that they do not climb inside the drum.

- 1 Ensure the lint filter is clean.

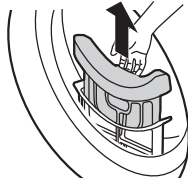

- Open the door and ensure the lint filter is clean. When the filter is full with lint, drying times will be longer than usual.

- 2 Place the clothes into the drum after sorting and close the door.

- Push the clothes deep into the drum so that the clothes keeps away from the door seal. When the clothes get stuck between the door and seal, they may get damaged while drying.
- The clothes should be sorted by fabric types and dryness level.
- All strings and attached belts of clothes should be well tied and fixed before being put into the drum.

- 3 Press the **Power** button to turn the appliance on.

- Depending on the models, the **Power** button may light up to indicate that the appliance is ready for dry.

- 4 Press the cycle button repeatedly until the desired cycle is selected.

- 5 Hold the **Start/Pause** button to start the drying programme.

NOTE

- The appliance washes lint, which builds up onto the surface of the condenser, automatically using water that is condensed from the clothes during operation.
- The frequency of cleaning condenser may vary depending on the size and the initial moisture amount of the clothes.

- 6 After the drying programme has finished, open the door and unload the clothes.

CAUTION

- Be careful! The drum inside may still be hot.

- 7 Press the **Power** button to turn the appliance off.

- 8 Clean the lint filter.

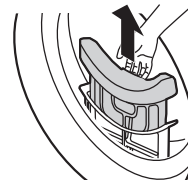

- 9 To help reduce odours from forming, the dryer's door can be left open or slightly ajar for a short period of time if possible to help ventilate the drum after use.

40 OPERATION-DRYER

⚠ WARNING

- For safety reasons, do not allow children or animals to enter the appliance. It may cause damage or injury.

NOTE

- The final part of a tumble dry cycle occurs without heat (cool down cycle) to ensure that the clothes are left at a temperature that ensures the clothes will not be damaged.
- A high atmospheric temperature and a small room may both increase drying time as well as energy consumption.

Preparing the Laundry

NOTE

- Do not overload the appliance for the best drying performance and most efficient energy usage.

Checking the clothes before loading

⚠ CAUTION

- Check that the clothes are not stuck between appliance and door, otherwise the clothes may get damaged while drying.
- Observe the maximum load capacity on the programme table for the relevant drying programme to get optimum drying results. Overloading gives a poor drying result and causes unnecessary creasing.
- Do not load soaking wet clothes into the appliance. It will cause an increasing of drying time and energy consumption. Make sure that the clothes are spun thoroughly before loading.
- A mixed fabric load can cause the drying time to be extended and the time remaining in the display to pause during active drying. The

remaining time will then continue when it is the actual time that remains.

- Make sure to empty all pockets. Items such as nails, hair clips, matches, pens, coins and keys can damage both your appliance and clothes.
- Remove loose belts and close zippers, hooks and strings to make sure that these items do not snag other clothes.

Sorting the Clothes

Clothes have their own fabric care labels, so drying according to the fabric care label is recommended. Sort the clothes into size and type of fabric and then prepare the clothes according to the symbols on the fabric care labels.

Woollens

- Be sure to follow fabric care label symbols first. Wool may not be completely dried from the cycle, so do not repeat drying. Pull woollens to their original shape and dry them flat.

Woven and Loopknit Materials

- Some woven and loopknit materials may shrink, depending on quality.

Non-Iron and Synthetics

- Do not overload the appliance. Take out non-Iron items as soon as the appliance stops to reduce creases.

Baby Clothes and Night Gowns

- Always check fabric care labels.

Rubber and Plastics















- Do not dry any items made from or containing rubber or plastics such as:
 - Aprons, Bibs and Chair Covers
 - Curtains and Table Clothes
 - Bathmats

Fiberglass

- Do not dry fiberglass items in the appliance. Glass particles left in the appliance may be subsequently picked up by your clothes in later cycles.

Checking the Fabric Care Label

The symbols on the fabric care label tell you about the fabric content of your clothes and how it should be dried.

| Symbol | Description |
|---|------------------------------------|
|  | Dry |
|  | Tumble Dry |
|  | Permanent Press / Crease Resistant |
|  | Gentle / Delicate |
|  | Do not Tumble Dry |
|  | Do not Dry |
|  | High Heating |
|  | Medium Heating |
|  | Low Heating |
|  | No Heating / Air |
|  | Line Dry / Hang to dry |
|  | Drip Dry |
|  | Dry Flat |
|  | In the Shade |

42 OPERATION-DRYER

Control Panel and Programme Table

Control Panel Features

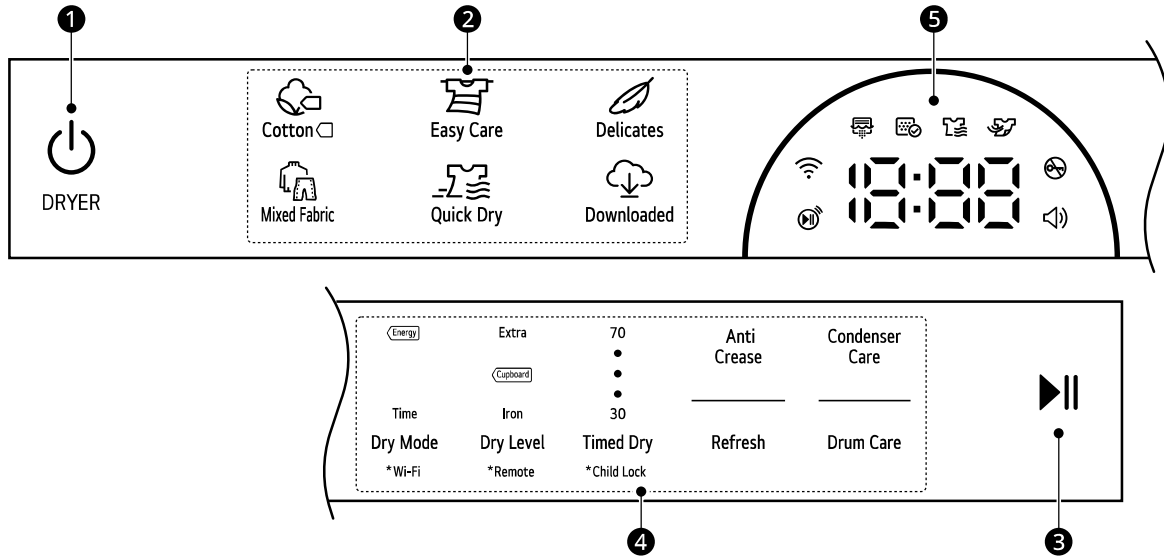

| | Description |
|---|--|
| 1 | <p>Power On/Off button</p> <ul style="list-style-type: none"> Press the button to turn the appliance on. Hold again to turn the appliance off. Pressing the Power button during a programme will cancel that programme and any load settings will be lost. |
| 2 | <p>Programme Buttons</p> <ul style="list-style-type: none"> Programmes are available according to the clothing type. The lamp will light up to indicate the selected programme. |
| 3 | <p>Start/Pause Button</p> <ul style="list-style-type: none"> This Start/Pause button is used to start or pause a dry programme. When in pause, the power is turned off automatically after a certain time for safety reasons. |



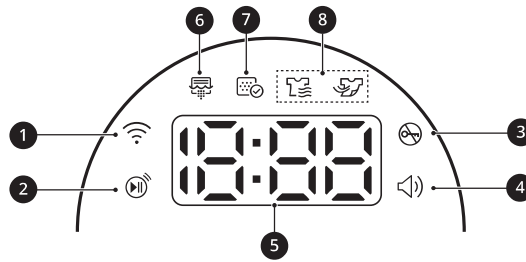

| | Description |
|---|--|
| 4 | <p>Additional Programme Buttons / Extra Options and Functions</p> <ul style="list-style-type: none"> Use these buttons to select the desired options for the selected programme. Not all options are available in each programme. <p>Remote</p> <ul style="list-style-type: none"> With the LG ThinQ app, you can use a smartphone to control your appliance remotely. In order to use the Remote Start function, refer to SMART FUNCTIONS. <p>Wi-Fi</p> <ul style="list-style-type: none"> Press and hold Dry Mode button for 3 seconds to initiate the connection of the appliance to the LG ThinQ application. |
| 5 | <p>Time and Status Display</p> <ul style="list-style-type: none"> The display shows the settings, estimated remaining time, options, and status messages. When the appliance is turned on, the default settings in the display will illuminate. |

Time and Status Display





| | Description |
|---|--|
| 1 | <p>Wi-Fi lights up when the appliance is connected to Wi-Fi network at home.</p> |
| 2 | <p>Remote control lights up when the remote control feature is activated.</p> |
| 3 | <p>Door lock lights up when the programme starts and the door is locked.</p> |
| 4 | <p>Beep lights up when the beep is on. This function can be turned on or off only through the LG ThinQ application.</p> |
| 5 | <p>Time Remaining Display</p> <ul style="list-style-type: none"> When a drying programme is selected, drying time for the selected programme is displayed. This time will change when you set the extra options for the programme. Error messages will appear when the appliance diagnose problems. |

44 OPERATION-DRYER

| | Description |
|---|---|
| 6 | <p> lights up or blinks while the condenser is being washed or the thawing mode is operating.</p> <ul style="list-style-type: none"> Condenser cleaning operates every 30 drying cycles. <p>NOTE</p> <ul style="list-style-type: none"> Drying times will be longer than usual when the condenser is being washed. If a small amount of clothes are dried, the condenser will not be washed because the accumulated water during the drying cycle is not enough to wash the condenser. |
| 7 | <p> lights up when the lint filter should be cleaned or is inserted.</p> <ul style="list-style-type: none"> Cleaning notice: When you press the Power button, the icon will become displayed. Missing notice: When the lint filter is not inserted the appliance will not operate. |
| 8 | <p>Programme Status Indicators</p> <ul style="list-style-type: none">  lights up when the appliance is in drying progress.  lights up when the appliance is in cooling progress. |

Drying Programme Guide

| Programme | [Cotton]  | Max. Load Capacity | Rating |
|---------------------------------|--|--------------------|--------|
| Description | Use for drying all normal items such as cotton, linen, shirts, jeans or mixed loads, except delicate fabrics such as wool or silk. | | |
| Dry Level | Default : Cupboard | Available : All | |
| Note for test institutes | <ul style="list-style-type: none"> Set programme at [Cotton]  + Cupboard + Energy (Full & Half Load) for test in accordance in conformity with EN 61121 and Regulation 932/2012. [Cotton]  + Cupboard + Energy is the most efficient programme in terms of the test conditions proposed by EN 61121 and Regulation 932/2012. The test results depend on room temperature, type and amount of load, water hardness, fluctuations in the main electricity supply and chosen additional options. | | |

| Programme | [Easy Care] | Max. Load Capacity | 2.5 kg |
|--------------------|--|-----------------------------------|--------|
| Description | Dries clothes that do not need ironing after drying. | | |
| | <ul style="list-style-type: none"> Use for polyamide, acrylic, polyester. | | |
| Dry Level | Default : Cupboard | Available : Cupboard, Iron | |

| | | | |
|--------------------|--|---------------------------|---------------|
| Programme | [Delicates] | Max. Load Capacity | 1.5 kg |
| Description | Use this programme for drying dress shirts/blouses, nylons, lingerie, or sheer and lacy clothes which can easily be damaged. | | |
| Dry Level | Not adjustable | | |

| | | | |
|--------------------|--|---------------------------|-------------|
| Programme | [Mixed Fabric] | Max. Load Capacity | 4 kg |
| Description | Dries mixed fabrics simultaneously. <ul style="list-style-type: none"> Use for various kind of fabrics except special garments (silk/delicate, sports wear, dark clothes, wool, duvet/curtains). | | |
| Dry Level | Default : Cupboard | Available : All | |

| | | | |
|--------------------|---|---------------------------|-------------|
| Programme | [Quick Dry] | Max. Load Capacity | 1 kg |
| Description | Use this programme for drying light or small items. | | |
| Dry Level | Not adjustable | | |

| | | | |
|--------------------|--|---|---|
| Programme | [Downloaded] | - | - |
| Description | This programme allows you to download a new and special drying programme to your appliance with a smartphone. The default programme is [Allergy Care] . | | |

Extra Options

| Programme | Dry Mode |
|--|-----------------------------|
| [Cotton] <input type="checkbox"/> | Energy ^{*1} |
| | Time |
| [Easy Care] | Energy ^{*1} |
| [Delicates] | Energy ^{*1} |
| [Mixed Fabric] | Energy |
| | Time ^{*1} |
| [Quick Dry] | Time ^{*1} |

*1 This option is automatically included in the programme.

46 OPERATION-DRYER

NOTE

- Only **[Cotton]**, **[Easy Care]** and **[Mixed Fabric]** programmes are available to select dryness level.
 - **Anti Crease** option can be selected for every drying programme.
 - The estimated time remaining will change if you select extra options for the programme.
-

Extra Options and Functions

Customizing a Drying Programme

Each programme has default settings that are selected automatically. You may also customize these settings using these buttons.

Dry Mode

Press the **Dry Mode** button repeatedly to offer the option of saving energy or time.

- **Energy:** Energy saving option.
- **Time:** Time saving option.

NOTE

- Selectable options will differ depending on the selected programme.

Dry Level

It allows you to select a dryness level for the drying programme.

- **Extra:** For thick and quilted fabrics
- **Cupboard:** For fabrics that do not need to be ironed
- **Iron:** For fabrics that need to be ironed

Timed Dry

Use this option to manually select the drying time, from 30 to 70 minutes, in 10-minute increments. Use this for small loads or to reduce wrinkles.

NOTE

- Clothes might be still damp depending on the fabric type of the clothes after drying. In this case, use this option to dry the clothes more thoroughly.

Follow the next steps to customize a drying programme:

- 1 Prepare the clothes and load the drum.
- 2 Press the **Power** button.

- 3 Select a drying programme.
- 4 Customize the drying programme (**Dry Mode**, **Dry Level**, and **Timed Dry**) as necessary.
- 5 Hold the **Start/Pause** button.

Using Special Options

You can customize the programmes by using the following special options:

Anti Crease

Selecting this option will tumble the load periodically for up to 2 hours after the selected programme, or until the door is opened. This is helpful in preventing wrinkles when you are unable to remove items from the dryer immediately.

- Press the **Anti Crease** button before you start a drying programme.

NOTE

- When the option is set, a rectangle with a dashed line and **End** appears on the display until the feature is off.
- When the option is set, only the **Power**, **Start/Pause** and **Anti Crease** buttons works after the drying programme ends.
- When a drying programme is running, pause the programme first to set the option.
- Always turn off the appliance before unloading the clothes.

Follow the next steps to use a special option.

- 1 Press the **Power** button.
- 2 Select a drying programme.
- 3 Select the **Anti Crease** option.

48 OPERATION-DRYER

4 Hold the **Start/Pause** button.

Special Cycle

Refresh

This cycle helps reduce odours in clothes that do not require washing.

Rack Dry

This programme is designed for use with clothes that must be dried flat, without tumbling, including sweaters and delicate fabrics.

To use the programme, you need a dryer rack that is placed inside the appliance. Before drying, discard packing materials of the dryer rack.

This programme can be downloaded to your appliance with a smartphone.

NOTE

- Some models are not sold with all of the available accessories, you may need to purchase the dryer rack first if it was not provided with your model. Please contact LG Electronics Customer Information Centre or visit the LG Website at <http://www.lg.com> for purchase.

1 Open the door.

2 Insert the hook of dryer rack to the drum centre.

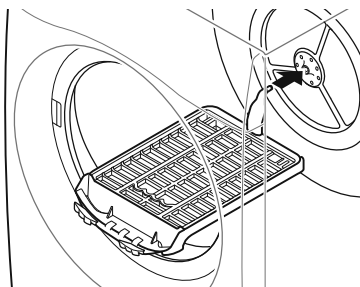

3 Place the dryer rack on the structure above the lint filter and press it to complete assembly.

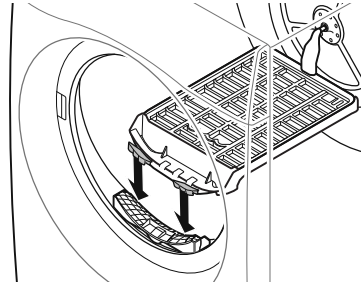

4 Place wet items on top of the rack. Allow space around items for air to circulate.

- The dryer rack does not move, but the drum will rotate.

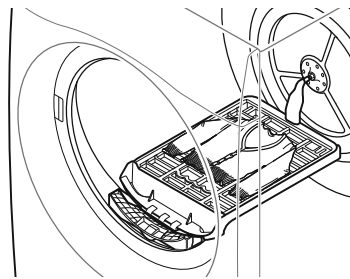

5 Close the door.

6 Turn power on and select **Timed Dry** to finely adjust the drying time.

7 Press the **Start/Pause** button.

NOTE

- Check the lint filter and remove any lint accumulated from items dried on the rack.

Settings

Child Lock

Use this option to disable the controls. This function can prevent children from changing cycles or operating the appliance.

NOTE

- Once this function is set, all buttons are locked except the **Power** button.
- When the controls are locked, **⏸** and the remaining time are alternatively shown on the display during the dry while this function is engaged.
- Turning off the power will not reset this function. You must deactivate this function before you can access any other functions.

Locking the Control Panel

- 1 Turn on the power.
- 2 Press and hold the **Timed Dry** button for 3 seconds to activate this function.
 - A beeper will sound, and **⏸** will appear on the display.

Unlocking the Control Panel

- 1 Turn on the power.
- 2 Press and hold the **Timed Dry** button for 3 seconds to deactivate this function.

50 SMART FUNCTIONS

SMART FUNCTIONS

Using LG ThinQ Application

The **LG ThinQ** application allows you to communicate with the appliance using a smartphone.

LG ThinQ Application Features

Communicate with the appliance from a smartphone using the convenient smart features.

Remote Start

It allows you to control the appliance remotely from the **LG ThinQ** application.

Download Cycle

You can download new and special cycles that are not included in the basic cycles on the appliance. A variety of specialty cycles specific to the appliance can be downloaded to the successfully registered appliances.

Once cycle download is completed in the appliance, the appliance keeps the downloaded cycle until a new cycle is downloaded.

NOTE

- Only one downloaded cycle can be stored on the appliance at a time.

Cloud Cycle

The Cloud cycles include many cycles which are started from the **LG ThinQ** application. However, the Cloud cycle is deleted from the appliance when the power is turned off.

Smart Pairing

This function automatically selects the drying cycle to match the washing cycle.

- This function is not default. This function can be turned on or off only through the **LG ThinQ** application.
- You can't use the **Smart Pairing** function 3 hours after the washing cycle has finished.

Tub Clean Coach (Washer)

This function shows how many cycles remain before it is time to run the **Tub Clean** function.

Energy Monitoring

This function checks the energy consumption of the recently used cycles and monthly average.

Smart Diagnosis

This function provides useful information for diagnosing and solving issues with the appliance based on the pattern of use.

Settings

Allows you to set various options on the appliance and in the application.

Push Alert

When the cycle is complete or the appliance has problems, you have the option of receiving push notifications on a smartphone. The notifications are triggered even if the **LG ThinQ** application is off.

NOTE

- If you change your wireless router, Internet service provider, or password, delete the registered appliance from the **LG ThinQ** application and register it again.
- The application is subject to change for appliance improvement purposes without notice to users.
- Functions may vary by model.

Installing LG ThinQ App and Connecting an LG Appliance

Models with QR Code

Scan the QR code attached to the product using the camera or a QR code reader app on your smartphone.

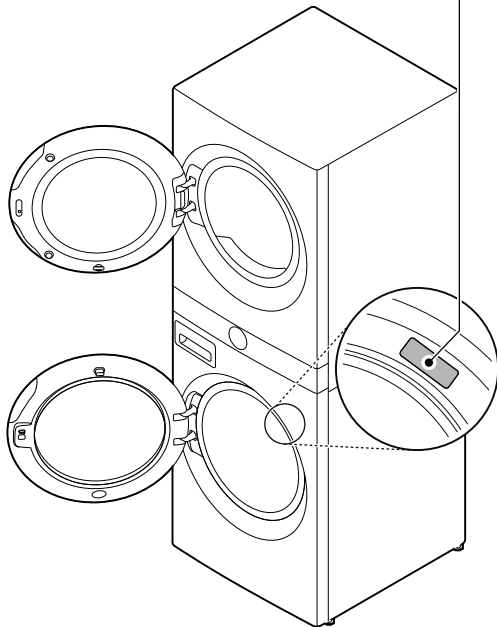

instructions in the app to complete the process.

NOTE

- You may be asked to provide a password to connect to the LG network (not your home network) during the Wi-Fi setup. The password is the last 4 characters of the network name, repeated twice, with no spaces. For example, if the network name appears as LG_XXXX_8b92, then you would enter 8b928b92 as your password. The password is case sensitive and the last 4 characters are unique to your appliance.
- To verify the Wi-Fi connection, check that the  icon on the control panel is lit.
- The appliance supports 2.4 GHz Wi-Fi networks only. To check your network frequency, contact your Internet service provider or refer to your wireless router manual.
- **LG ThinQ** is not responsible for any network connection problems or any faults, malfunctions, or errors caused by network connection.
- If the appliance is having trouble connecting to the Wi-Fi network, it may be too far from the router. Purchase a Wi-Fi repeater (range extender) to improve the Wi-Fi signal strength.
- The Wi-Fi connection may not connect or may be interrupted because of the home network environment.
- The network connection may not work properly depending on the Internet service provider.
- The surrounding wireless environment can make the wireless network service run slowly.
- If the appliance cannot be registered due to problems with the wireless signal transmission, unplug the appliance and wait about a minute before trying again.
- If the firewall on your wireless router is enabled, disable the firewall or add an exception to it.
- The wireless network name (SSID) should be a combination of English letters and numbers. (Do not use special characters.)
- Smartphone user interface (UI) may vary depending on the mobile operating system (OS) and the manufacturer.

ENGLISH

Models without QR Code

- 1 Search for and install the **LG ThinQ** app from the Google Play Store or Apple App Store on a smartphone.
- 2 Run the **LG ThinQ** app and sign in with your existing account or create an LG account to sign in.
- 3 Touch the add (+) button on the **LG ThinQ** app to connect your LG appliance. Follow the

52 SMART FUNCTIONS

NOTE

- If the security protocol of the router is set to **WEP**, network setup may fail. Change the security protocol (**WPA2** is recommended) and connect the product again.

Using the Appliance Remotely

Remote Start

Use a smartphone to control your appliance remotely. You can also monitor your cycle operation so you know how much time is left in the cycle.

Using this function

- 1 Put the clothes into the drum.
- 2 Press the **Power** button.
- 3 Press and hold **Remote** button for 3 seconds to enable the remote control function.
- 4 Start a cycle from the **LG ThinQ** application on your smartphone.

NOTE

- Once this function is enabled, you can only start a cycle from the **LG ThinQ** smartphone application. If the cycle is not started, the appliance will wait to start the cycle until it is turned off remotely from the application or this function is disabled.
- If the door has been opened, you can not start a cycle remotely.

Disable this function manually

When this function is activated, press and hold the **Remote** button for 3 seconds.

Delay End

Setting this function allows the appliance to start automatically and finish after a specified time.

Using this function

- 1 Put the clothes into the drum.
- 2 Press the **Power** button.
- 3 Run **LG ThinQ** application and select the product.
 - For washing, select the washer.
 - For drying, select the dryer.
- 4 Select a washing or drying programme.
- 5 Touch the **Delay End** and set the delay time.
- 6 Start a cycle from the **LG ThinQ** application on your smartphone.

NOTE

- The delay time is the time to the end of the programme, not the start. The actual running time may vary due to water temperature, clothes and other factors.
- Avoid using liquid detergent for this function.

Radio Equipment Specifications

| Module Name | LCWB-001 |
|---------------------------------|---------------------|
| Wireless LAN Frequency Range | 2412 MHz - 2472 MHz |
| Wireless LAN Output Power (Max) | 18.14 dBm |

Wireless function S/W version: V 1.0

For consideration of the user, this device should be installed and operated with a minimum distance of 20 cm between the device and the body.

Declaration of Conformity



Hereby, LG Electronics declares that the radio equipment type Washing Machine is in compliance with Directive 2014/53/EU. The full text of the EU declaration of conformity is available at the following internet address:

<http://www.lg.com/global/support/cedoc/cedoc#>
 LG Electronics European Shared Service Centre B.V.
 Krijgsman 1, 1186 DM Amstelveen, The Netherlands

Declaration of Conformity for UK

Hereby, LG Electronics declares that the radio equipment type Washing Machine is in compliance with the relevant statutory requirements. The full text of the UK declaration of conformity is available at the following internet address :

<http://www.lg.com/global/support/cedoc/cedoc#>

Activating Network Connection

- 1 Run the **LG ThinQ** application.
- 2 Select and touch the **Wash Tower** in the application.
- 3 Press the **Power** button on the control panel.
- 4 Press and hold **Wi-Fi** button for 3 seconds on the control panel.
 - The Wi-Fi LED blinks during the connection process.

Deactivating Network Connection

Washer

- 1 Press the **Power** button on the control panel.
- 2 Press and hold the **Spin** and **TurboWash** buttons simultaneously for 3 seconds to deactivate Network Connection.

Dryer

- 1 Press the **Power** button on the control panel.
- 2 Press and hold the **Timed Dry** and **Condenser Care** buttons simultaneously for 3 seconds to deactivate Network Connection.

ENGLISH

Standby Power Consumption

| | |
|---|-------------------|
| Standby power consumption - Washer | 0.5 W |
| Standby power consumption - Dryer | 0.49 W |
| Network standby power consumption | 2.0 W |
| The period of time after which the power management function, or a similar function, switches the equipment automatically into standby and/or off mode and/or the condition providing networked standby | 10 minutes |

NOTE

- The activation of the network connection may increase the power consumption of the appliance.

54 SMART FUNCTIONS

Open Source Software Notice Information

To obtain the source code that is contained in this product, under GPL, LGPL, MPL, and other open source licenses that have the obligation to disclose source code, and to access all referred license terms, copyright notices and other relevant documents, please visit <https://opensource.lge.com>.

LG Electronics will also provide open source code to you on CD-ROM for a charge covering the cost of performing such distribution (such as the cost of media, shipping, and handling) upon email request to opensource@lge.com.

This offer is valid to anyone in receipt of this information for a period of three years after our last shipment of this product.

Smart Diagnosis

Use this feature to help you diagnose and solve problems with your appliance.

NOTE

- For reasons not attributable to LGE's negligence, the service may not operate due to external factors such as, but not limited to, Wi-Fi unavailability, Wi-Fi disconnection, local app store policy, or app unavailability.
- The feature may be subject to change without prior notice and may have a different form depending on where you are located.

Using LG ThinQ to Diagnose Issues

If you experience a problem with your Wi-Fi equipped appliance, it can transmit troubleshooting data to a smartphone using the **LG ThinQ** application.

- Launch the **LG ThinQ** application and select the **Smart Diagnosis** feature in the menu. Follow the instructions provided in the **LG ThinQ** application.

Using Audible Diagnosis to Diagnose Issues

Follow the instructions below to use the audible diagnosis method.

- Launch the **LG ThinQ** application and select the **Smart Diagnosis** feature in the menu. Follow the instructions for audible diagnosis provided in the **LG ThinQ** application.

- 1 Press the **Power** button to turn on the appliance.
 - Do not press any other buttons.
- 2 Hold the mouthpiece of your phone in front of the appliance.
 - Washer: Hold the phone to the right of the **Start/Pause** button.
 - Dryer: Hold the phone to the left of the **Power** button.
- 3 Press and hold the **Prepare to Dry** (Washer) / **Drum Care** (Dryer) buttons for 3 seconds or until the audible tones start. Hold the smartphone mouthpiece to the appliance until the data transfer is complete.
 - Keep the smartphone in place until the data transfer has finished. Time remaining for data transfer is displayed.
- 4 After the data transfer is complete, the diagnosis will be displayed in the application.

NOTE

- For best results, do not move the smartphone while the tones are being transmitted.

MAINTENANCE

⚠ WARNING

- Unplug the appliance before cleaning to avoid the risk of electric shock. Failure to follow this warning may result in serious injury, fire, electric shock, or death.
- Never use harsh chemicals, abrasive cleaners, or solvents to clean the appliance. They may damage the finish.

ENGLISH

Washer

What to Clean

Always remove items from the washing machine as soon as the cycle is complete. Leaving damp items in the washing machine can cause wrinkling, colour transfer, and odour.

- After the wash cycle is finished, wipe the door and door seal to remove any moisture.
- Leave the door slightly open to dry the drum.
- Wipe the appliance with a dry cloth to remove any moisture.

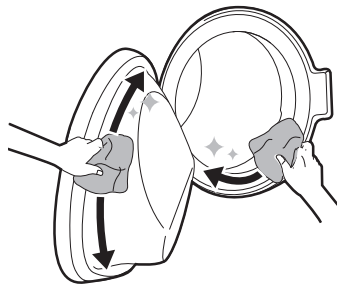

⚠ WARNING

- Leave the door open to dry inside of the appliance only if the children are supervised at home.

Cleaning the Exterior

Proper care of your appliance can extend the service life.

Exterior

- Immediately wipe off any spills.
- Wipe with a damp cloth and then again with a dry cloth ensuring there is no moisture in cabinet joints or crevices.
- Do not press on the surface or the display with sharp objects.

Door

- Wash with a damp cloth on the outside and inside and then dry with a soft cloth.

⚠ WARNING

- Do not attempt to separate any panels or disassemble the appliance. Do not apply any sharp objects to the control panel in order to operate the appliance.

Tub Clean

This is a special function to help clean the inside of the appliance by soaking, washing, rinsing and spinning.

Run this function **once a month** (or more often if needed) to reduce build-up of detergent and softener and other residue.

- If there is a bad smell or mildew inside the appliance, run this function **once a week for 3**

56 MAINTENANCE

weeks in addition to the regularly prompted intervals.

NOTE

- The **ECU** message will be displayed to alert to the recommendation of operating this function.

- 1 Remove any clothing or items from the appliance and close the door.
- 2 Open the dispenser drawer and add anti limescale powder to the main wash compartment.
 - Tablets can be placed directly into the drum as an alternative to powder.
- 3 Close the dispenser drawer slowly.
- 4 Turn on the power, and then press the **Tub Clean** button.
- 5 Press the **Start/Pause** button to start.
- 6 Leave the door open to dry the inside of the appliance completely.
 - When the inside of the appliance is not dried completely, it may cause a bad smell or mildew.

⚠ WARNING

- Leave the door open to dry inside of the appliance only if the children are supervised at home.

Cleaning the Water Inlet Filter

The water inlet filter collects lime or any sediment that may be in water that is supplied to the appliance. Clean the inlet filter every six months or

so, or more often if the water is very hard or contains traces of limescale.

- Turn off the water supply taps to the appliance if the appliance is to be left for a certain period of time (e.g. holiday), especially if there is no floor drain (gully) in the immediate vicinity.
- **IE** error message will be displayed on the control panel when the water is not entering the detergent drawer.

- 1 Turn off the power and the water tap and then unscrew the water inlet hose.

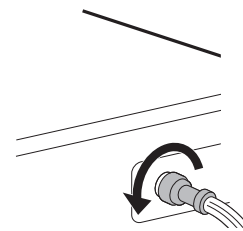

- 2 Remove the water inlet filter with small pliers and then clean the filter using a medium bristle tooth brush.

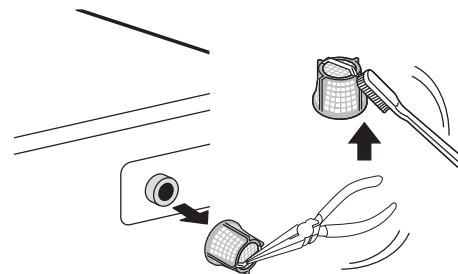

Cleaning the Drain Pump Filter and Performing an Emergency Water Evacuation

The drain filter collects threads and small objects that may have been accidentally left in the clothes. Make sure that the filter is clean every six months to ensure smooth running of your appliance. Allow the water to cool before cleaning the drain pump filter. Open the door in an emergency or perform an emergency water evacuation.

- 1 Unplug the appliance.

- 2 Open the cover cap and pull out the drain tube.

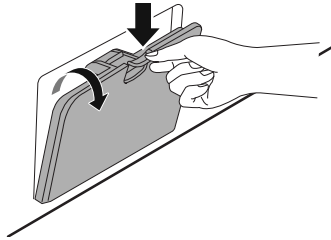

- 3 Remove the drain plug from the drain tube first ①, and then drain the water. Then slowly unscrew the drain pump filter ② to drain the remaining water and then proceed to remove any debris or objects from the filter.

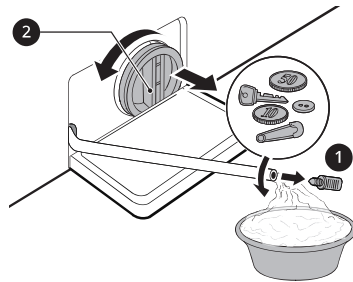

- 4 After cleaning the drain pump filter, carefully reinsert the filter and screw the drain cap back in clockwise carefully to avoid cross threading and leakage. Reinsert the plug back into the drain tube and place the tube into its holder.

- 5 Close the cover cap.

⚠ CAUTION

- Be careful when draining, as the water may be hot.
- Run the drum cleaning programme once a month (or more often, as needed) to remove excess detergent and other debris.

Cleaning the Dispenser Drawer

Detergent and fabric softener can build up in the dispenser drawer. Liquid detergents can remain

under the dispenser drawer and not dispense completely. Remove the drawer and inserts and check for build-up of cleaning products **once or twice a month**.

- 1 Remove the detergent dispenser drawer by pulling the drawer straight out until the drawer stops.
 - Then gently pull the drawer outward while pressing hard the disengage button.

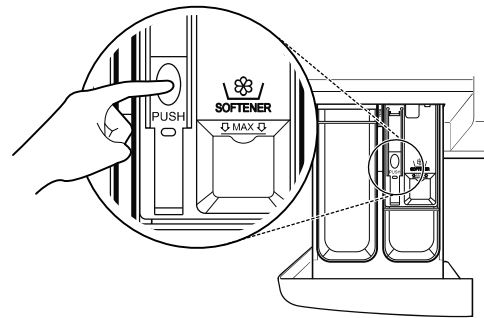

- 2 Remove the build-up of detergent and softener.
 - Rinse the drawer and the components of the drawer with warm water to remove the build-up from detergent and softener. Use only water to clean the dispenser drawer. Dry the drawer and the components of the drawer with a soft cloth or towel.
- 3 To clean the drawer opening, use a cloth or small, non-metal brush to clean the recess.
 - Remove all residue from the upper and lower parts of the recess.

- 4 Wipe any moisture off the recess with a soft cloth or towel.

- 5 Reassemble the components of the drawer to the proper compartments and insert the drawer.

58 MAINTENANCE

Dryer

⚠ WARNING

- Remove the power plug when you clean the appliance. Not removing the plug may result in electric shock.

Cleaning the Lint Filter

⚠ CAUTION

- Clean the lint filter in the proper way referring to the following instructions. Failure to do so, the lint that is accumulated on the heat exchanger may not be cleaned properly.

NOTE

- Unload the all of the laundries from the appliance before pull out the lint filter.
- After cleaning the lint filter insert them in a place. If the lint filter is not in the appliance, you can not operate the appliance.

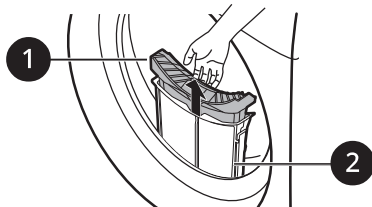

① Inner Filter

- Always clean the inner filter before and after use.

② Outer Filter

- Clean the outer filter after drying 10 times or when the lint is accumulated into the outer filter.
- A chime will sound after every 10 drying cycles and the  icon will blink.

Clean the inner filter

- Pull out the inner filter from the outer filter and then open the inner filter.

- Open the filter by unfolding it in the direction of the arrow.

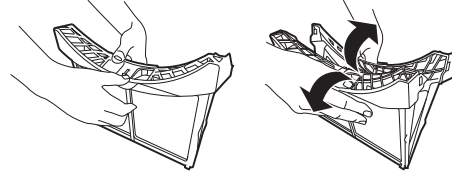

- Clean a large cluster of lint first, then clean the residual lint using vacuum cleaner or washing under running water.

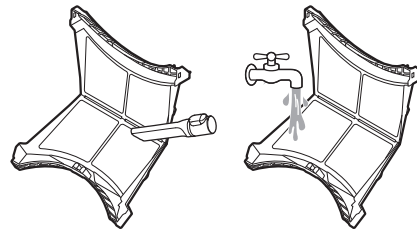

- Dry the filter completely if the filter is moist. Failure to do so, odour may occur in the appliance.

- After drying the inner filter completely, close the filter by pushing down its center.

- Ensure the left and right side of the inner filter is closed properly.

- Insert the inner filter into the outer filter.

Clean the outer filter

- Remove the dust or lint around the filter inlet.

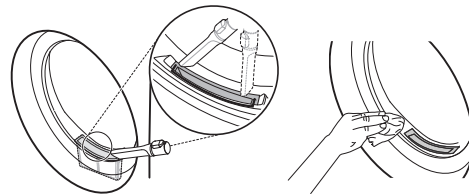

⚠ CAUTION

- When the lint drops into the filter inlet, it may cause degradation of drying performance and increase in drying time.

2 Pull out the outer filter.

3 Remove the inner filter.

4 Open the outer filter by unfolding in the direction of the arrow grasping the top edge of the outer filter.

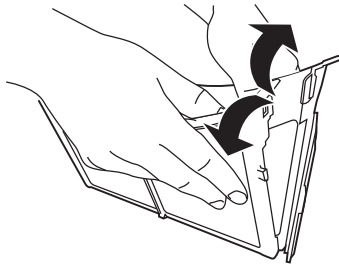

5 Clean the residual lint using vacuum cleaner or washing under running water.

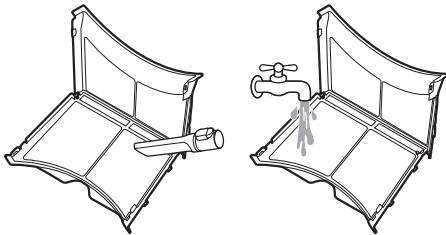

- Dry the filter completely if the filter is moist. Failure to do so, odour may occur in the appliance.

6 Close the outer filter while pushing the side **1** of the filter.

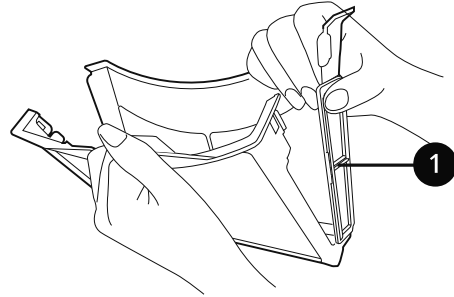

NOTE

- Ensure the side of the filter is closed properly. Failure to do so, any lint accumulated on the filter may get into the appliance and may cause degradation of the drying performance.

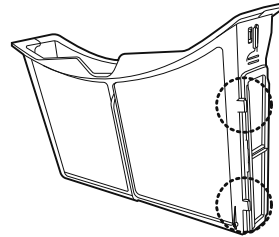

7 Close them, and reinsert the both lint filters.

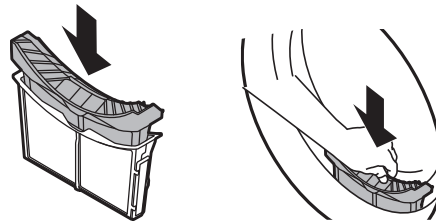

⚠ CAUTION

- Do not load or remove any clothes when the lint filter is not in a place. The clothes can drop into the filter inlet and it may cause the appliance to malfunction.

60 MAINTENANCE

Wiping the Moisture Sensor

This device senses the moisture level of the clothes during operation, which means it must be cleaned regularly to remove any build-up of lime scale on the surface of the sensor.

Wipe the sensors inside the drum.

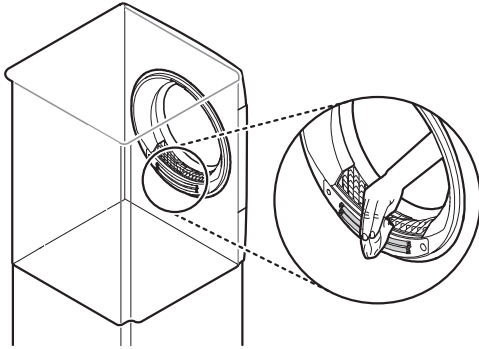

⚠ CAUTION

- Do not wipe the moisture sensor with abrasive materials. Always clean the sensor with a dry rough acrylic sponge.

Cleaning the Cool Air Inlet Grill

Vacuum the cool air inlet grill 3 - 4 times a year to make sure there is no build up of lint or dirt that may cause improper air flow. Always unplug the appliance from the mains power before cleaning or vacuuming.

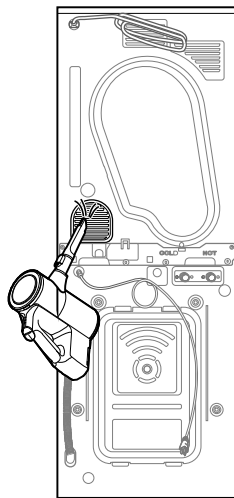

NOTE

- Warm air is expelled through the ventilation grill.
- Adequate room ventilation should be provided to avoid the contamination of air into the room from units burning other fuels, such as open fires.

Using Drum Clean Feature

With time and use, the appliance may form unpleasant odours that leave your clothes smelling after drying. Using this cleaning function periodically helps to reduce the unpleasant odours from the appliance.

⚠ CAUTION

- Remove all of the clothes from the appliance.

- Turn on the appliance.
- Press the **Drum Care** button.
- Hold the **Start/Pause** button.
 - This function operates for about 3 hours.
- Open the dryer's door to provide the appliance with enough air circulation for exhausting any remaining odours.

⚠ WARNING

- For safety reasons, do not allow children or animals to enter the appliance. It may cause damage or injury.

Using Condenser Clean Feature

The appliance washes lint, which builds up onto the surface of the condenser, automatically using water that is condensed from the clothes during

operation. However, you can clean the condenser manually if you want to clean it more often.

⚠ CAUTION

- Remove all of the clothes from the appliance.

- 1 Open the dryer's door and pull out both inner and outer filter.

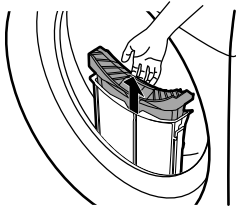

- 2 Pour 1 litre of clean water slowly into the entrance.

- Do not pour the water quickly as it will spill out.
- Pouring more than 1.5 litres of water into the compartment will cause water to leak back out.

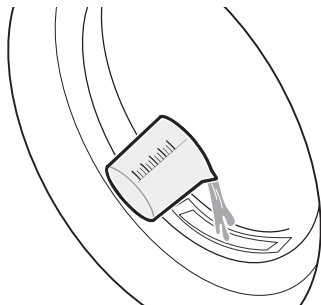

- 3 Reinsert both inner and outer filter and close the dryer's door.

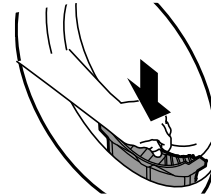

- 4 Turn on the appliance.

- 5 Press the **Condenser Care** button.

- 6 Hold the **Start/Pause** button to start the cleaning of the condenser.

- The cleaning of the condenser proceeds for 1 hour.

- 7 Open the dryer's door to provide the appliance with enough air circulation for more thorough drying of the tub after the cleaning has ended.

⚠ WARNING

- For safety reasons, do not allow children or animals to enter the appliance. It may cause damage or injury.

Information on LED Lighting

This product contains the light source of energy efficiency class G.

- The LED lighting automatically turns on and off in any of the following cases:
 - when opening and closing the door,
 - when pressing **Power** and **Start/Pause** Button.
- The LED lighting is not dimmable.
- The LED lighting does not contain mercury.
- Please see www.lg.com/global/recycling.

62 MAINTENANCE

NOTE

- This feature varies depending on the model purchased.
-

If the LED lighting is not working

Close the door and re-open, or press **Power** Button. If the LED lighting does not turn on, please contact the LG Electronics customer information centre. Do not attempt removal of the LED lighting.

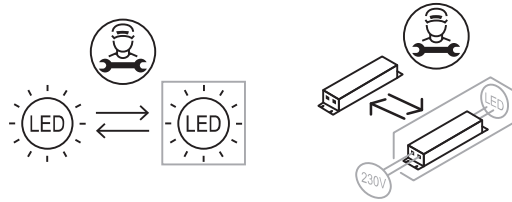

TROUBLESHOOTING

Operation of your appliance can lead to errors and malfunctions. The following tables contain possible causes and notes for resolving an error message or malfunction. It is recommended to read the tables carefully below in order to save your time and money that may cost for calling to LG Electronics service centre.

Washer

Error Messages

| Symptoms | Possible Cause & Solution |
|--|---|
| IE INLET ERROR | Water supply is not adequate in that location. Water does not enter appliance or it enters slowly. <ul style="list-style-type: none"> • Check another tap in the house. |
| | Water supply tap is not completely open. Water does not enter the appliance or it enters slowly. <ul style="list-style-type: none"> • Open fully tap. |
| | Water supply hose(s) are kinked. <ul style="list-style-type: none"> • Straighten hose or reinstall the water inlet hose |
| | The filter of the supply hose(s) are clogged. <ul style="list-style-type: none"> • Check and clean the inlet valve filter after turning off the taps and removing the hose connections to the washing machine. |
| UE UNBALANCE ERROR | The appliance has a system which detects and corrects the unbalance of the appliance. <ul style="list-style-type: none"> • The clothes may be too wet at the end of the cycle, rearrange the load to allow proper spinning. Close the door and press Start/Pause button. It may take a few moments before the appliance begins to spin. The door must be locked before spin can be achieved. |
| | Load is too small. This system may stop spinning or even interrupt the spin cycle altogether if individual heavy articles (e.g. bath mat, bath robe, etc.) are loaded. <ul style="list-style-type: none"> • Add 1 or 2 similar items or smaller articles of clothes to help balance the load. Close the door and press Start/Pause button. It may take a few moments before the appliance begins to spin. The door must be locked before spin can be achieved. |
| OE WATER OUTLET ERROR | Drain hose is kinked or clogged. Water in the appliance does not drain or drains slowly. <ul style="list-style-type: none"> • Clean and straighten the drain hose. |
| | The drain filter is clogged. <ul style="list-style-type: none"> • Check and clean the drain filter. |

64 TROUBLESHOOTING

| Symptoms | Possible Cause & Solution |
|--|---|
| dE 1/dE2 DOOR ERROR | <p>Door is open.</p> <ul style="list-style-type: none"> Close the door and make sure that nothing is caught under the door preventing it from closing completely. <p>Door sensor malfunctions.</p> <ul style="list-style-type: none"> Close the door. Please call LG service centre. You can find your local LG service centre phone number in the warranty card. |
| lE CONTROL ERROR | <p>This is a control error.</p> <ul style="list-style-type: none"> Unplug the power plug and call for service. |
| LE MOTOR LOCKED ERROR | <p>Over load in motor.</p> <ul style="list-style-type: none"> Let the appliance wait for 30 minutes until the motor is cooled down and then, restart the cycle. |
| FE OVERFLOW ERROR | <p>Water overfills due to a possible faulty water valve.</p> <ul style="list-style-type: none"> Close the water tap. Unplug the power plug. Call for service. |
| PE PRESSURE SENSOR ERROR | <p>Water level sensor malfunctions.</p> <ul style="list-style-type: none"> Close the water tap. Unplug the power plug. Call for service. |
| ∩S VIBRATION SENSOR ERROR | <p>Vibration sensor malfunctions.</p> <ul style="list-style-type: none"> Call for service. |
| FF FROZEN FAILURE | <p>Is supply/drain hose or drain pump frozen?</p> <ul style="list-style-type: none"> Supply warm water into the drum in order to unfreeze the drain hose and the drain pump. Cover the supply hose with wet and warm towel. |
| RE WATER LEAKAGE | <p>Water leaks.</p> <ul style="list-style-type: none"> Call for service. |
| PF POWER FAILURE | <p>Power failure or inadequate electrical service may have occurred during operation.</p> <ul style="list-style-type: none"> Press the Start/Pause button to restart the cycle. |

Noises You Might Hear

| Symptoms | Possible Cause & Solution |
|------------------------------------|---|
| Rattling and clanking noise | <p>Foreign objects, such as keys, coins, or safety pins may be in the drum.</p> <ul style="list-style-type: none"> Stop the appliance, check the drum for foreign objects. If the noise continues after the appliance is restarted, call for service. |
| Thumping sound | <p>Heavy clothes may produce a thumping sound. This is usually normal.</p> <ul style="list-style-type: none"> If the sound continues, the appliance is probably out of balance. Stop and redistribute the clothes. |

| Symptoms | Possible Cause & Solution |
|------------------------|---|
| Thumping sound | <p>The clothes may be out of balance.</p> <ul style="list-style-type: none"> Pause the programme and redistribute the clothes after the door unlocks. |
| Vibrating noise | <p>Package materials are not removed.</p> <ul style="list-style-type: none"> Remove package materials. |
| | <p>The clothes may be unevenly distributed in the drum.</p> <ul style="list-style-type: none"> Pause the programme and redistribute the clothes after the door unlocks. |
| | <p>Not all levelling feet are resting firmly and evenly on the floor.</p> <ul style="list-style-type: none"> See the Levelling the Appliance instruction to adjust the levelling of the appliance. |
| | <p>Floor not rigid enough.</p> <ul style="list-style-type: none"> Check if the floor is solid and does not flex. See the Installation Place Requirements to select the proper location. |

Operation

| Symptoms | Possible Cause & Solution |
|------------------------------------|--|
| Water is leaking. | <p>House drain pipes are clogged.</p> <ul style="list-style-type: none"> Unclog waste pipes. Contact plumber if necessary. |
| | <p>Leakage is caused by improper installation of drain hose or clogged drain hose.</p> <ul style="list-style-type: none"> Clean and straighten the drain hose. Check and clean the drain filter regularly. |
| | <p>Drain pump filter cap is not fitted correctly.</p> <ul style="list-style-type: none"> Refit the drain pump filter. |
| Appliance does not operate. | <p>Control panel has powered off due to inactivity.</p> <ul style="list-style-type: none"> This is normal. Press the Power button to turn the appliance on. |
| | <p>Appliance is unplugged.</p> <ul style="list-style-type: none"> Make sure that the cord is plugged securely into a working outlet. |
| | <p>Water supply is turned off.</p> <ul style="list-style-type: none"> Turn the water supply tap completely. |
| | <p>Controls are not set properly.</p> <ul style="list-style-type: none"> Make sure that the programme is correctly set. Close the door and press the Start/Pause button. |
| | <p>Door is open.</p> <ul style="list-style-type: none"> Close the door and make sure that nothing is caught under the door preventing it from closing completely. |

66 TROUBLESHOOTING

| Symptoms | Possible Cause & Solution |
|---|--|
| Appliance does not operate. | Circuit breaker/fuse is tripped/blown. <ul style="list-style-type: none"> Check house circuit breakers/fuses. Replace fuses or reset breaker. The appliance should be on a dedicated branch circuit. The appliance will resume the programme where it stopped once power is restored. |
| | Control needs to be reset. <ul style="list-style-type: none"> Press the Power button, then reselect the desired programme and press the Start/Pause button. |
| | Start/Pause was not pressed after a programme was set. <ul style="list-style-type: none"> Press the Power button, then reselect the desired programme and press the Start/Pause button. The appliance is turned off if the Start/Pause button is not pressed within a certain time. |
| | Extremely low water pressure. <ul style="list-style-type: none"> Check another tap in the house to make sure that household water pressure is adequate. |
| | Appliance is heating the water or making steam. <ul style="list-style-type: none"> The drum may stop operating temporarily during certain cycles, while water is safely heated to a set temperature. |
| Buttons may not function properly. | The Child Lock option is activated. <ul style="list-style-type: none"> Deactivate the Child Lock option if necessary. |
| Door does not open. | The door cannot be opened for safety reasons once the appliance starts. <ul style="list-style-type: none"> This is normal. You can safely open the door after  turns off. |
| Appliance is not filling properly. | Inlet filter clogged. <ul style="list-style-type: none"> Make sure the inlet filters on the fill valves are not clogged. |
| | Inlet hoses may be kinked. <ul style="list-style-type: none"> Check that inlet hoses are not kinked or clogged. |
| | Insufficient water supply. <ul style="list-style-type: none"> Make sure that both hot and cold water taps are turned on all the way. |
| | Hot and cold supply hoses are reversed. <ul style="list-style-type: none"> Check supply hose connections. |
| Appliance does not drain water. | Kinked drain hose. <ul style="list-style-type: none"> Ensure that the drain hose is not kinked. |
| | Drain located higher than 1.2 m above the floor. <ul style="list-style-type: none"> Make sure that the drain hose is no higher than 1.2 m above the bottom of the appliance. |
| Detergent is not dispensed incompletely or not dispensed at all. | Too much detergent is used. <ul style="list-style-type: none"> Follow the guidelines provided by the detergent manufacturer. |

| Symptoms | Possible Cause & Solution |
|---|--|
| Detergent is not dispensed incompletely or not dispensed at all. | <p>Drain Pump Filter may be blocked.</p> <ul style="list-style-type: none"> • Clean the Drain filter. |
| Cycle time is longer than usual. | <p>The load is too small.</p> <ul style="list-style-type: none"> • Add more items to allow the appliance to balance the loads. |
| | <p>Heavy articles are mixed with lighter items.</p> <ul style="list-style-type: none"> • Always try to wash articles with similar weight in order to allow the appliance to evenly distribute the weight of the load for spinning. |
| | <p>The load is out of balance.</p> <ul style="list-style-type: none"> • Manually redistribute the load if articles have become tangled. |
| Cycle end is delayed. | <p>Unbalance is detected or suds removing programme is on.</p> <ul style="list-style-type: none"> • This is normal. The time remaining shown on the display is only an estimated duration. Actual time may vary. |

68 TROUBLESHOOTING

Performance

| Symptoms | Possible Cause & Solution |
|---------------------------|--|
| Poor stain removal | <p>Previously set stains.</p> <ul style="list-style-type: none"> Articles that have been previously washed may have stains which have been set. These stains may be difficult to remove and may require hand washing or pre-treating to aid in stain removal. |
| Staining | <p>Bleach or softener is dispensed too soon.</p> <ul style="list-style-type: none"> Dispenser compartment is overfilled. It makes bleach or softer dispensed rapidly. Always measure bleach or softener to prevent overfilling. Close the detergent dispenser slowly. |
| | <p>Bleach or softener was added directly to the clothes in the drum.</p> <ul style="list-style-type: none"> Always use the detergent dispenser to ensure that bleach or softener is properly dispensed at the right time in the programme. |
| | <p>Clothes were not properly sorted.</p> <ul style="list-style-type: none"> Always wash dark colours separately from light colours and whites to prevent discoloration. Never wash heavily soiled items with lightly soiled items. |
| Wrinkling | <p>Appliance is not unloaded promptly.</p> <ul style="list-style-type: none"> Always remove items from the appliance as soon as the programme is complete. |
| | <p>Appliance is overloaded.</p> <ul style="list-style-type: none"> The appliance can be fully loaded, but the drum should not be tightly packed with items. The door of the appliance should be closed easily. |
| | <p>Hot and cold water supply hoses are reversed.</p> <ul style="list-style-type: none"> Hot water rinse can set wrinkles in garments. Check the supply hose connections. |
| | <p>Spin speed may be too high.</p> <ul style="list-style-type: none"> Set the spin speed to suit the garment type. |

Odour

| Symptoms | Possible Cause & Solution |
|-------------------------------------|--|
| Musty or mildewy odour in appliance | Inside of drum is not cleaned properly. <ul style="list-style-type: none"> Run the Tub Clean function regularly. |
| | Odours can occur if the drain hose is not properly installed, causing siphoning (water flowing back inside of the appliance). <ul style="list-style-type: none"> When installing the drain hose, make sure that it does not get kinked or blocked. |
| | If the detergent dispenser is not cleaned regularly, odours can occur from mold or foreign substances. <ul style="list-style-type: none"> Remove and clean the detergent dispenser, especially the top and bottom of the dispenser's opening. |

ENGLISH

Customer Care and Service

Contact an LG Electronics customer information centre.

- To find an LG Electronics authorised service personnel, visit our website at www.lg.com and follow the instructions found there.
- Self-repair is not recommended as it could further damage the device and void the guarantee.
- Spare parts referenced in Regulation 2019/2023 are available for a minimum duration of 10 years.

70 TROUBLESHOOTING

Dryer

Error Messages

| Symptoms | Possible Cause & Solution |
|----------------------------------|--|
| dE 1 / dE2 DOOR ERROR | <p>The door has been opened while the appliance is in operation or the appliance is being operated without the door being closed properly.</p> <ul style="list-style-type: none"> • Close the door completely. • If dE 1 / dE2 is not released, call for service. |
| dE4 DOOR ERROR | <p>Door switch detection is not working properly.</p> <ul style="list-style-type: none"> • Unplug the power plug and call for service. |
| tE 1 / tE2 TEMPERATURE ERROR | <p>Temperature Sensor has malfunctioned.</p> <ul style="list-style-type: none"> • Unplug the power plug and call for service. |
| F1 TEMPERATURE ERROR | <p>The temperature inside the drum has risen suddenly.</p> <ul style="list-style-type: none"> • Unplug the power plug and call for service. |
| LE 1 MOTOR LOCKED ERROR | <p>The motor has stopped suddenly.</p> <ul style="list-style-type: none"> • Check if the amount of clothes exceeds the maximum load capacity. • Unplug the power plug and call for service. |
| LE2 / AE COMPRESSOR ERROR | <p>The compressor has stopped suddenly.</p> <ul style="list-style-type: none"> • Unplug the power plug and call for service. |
| OE DRAIN PUMP ERROR | <p>The drain pump motor has malfunctioned.</p> <ul style="list-style-type: none"> • Unplug the power plug and call for service. <p>The surrounding temperature for installation is below zero.</p> <ul style="list-style-type: none"> • The recommended surrounding temperature for installation is 5 - 35 °C. |
| drn DRAIN WATER FAILURE ERROR | <p>The drain hose is not connected properly.</p> <ul style="list-style-type: none"> • Connect the drain hose properly. • Check if the drain hose is free of clogs or kinks and is not pinched behind or under the dryer. • If the message keeps appearing, unplug the power cord and call for service. |
| IF NONE LINT FILTER ERROR | <p>The lint filter is not in the appliance.</p> <ul style="list-style-type: none"> • Insert the lint filter. |
| P5 POWER SUPPLY ERROR | <p>Power cord is connected incorrectly.</p> <ul style="list-style-type: none"> • Check the connection of the power cord. • If the message keeps appearing, unplug the power cord and call for service. |

| Symptoms | Possible Cause & Solution |
|-------------|---|
| [] <-> End | <p>Indicates that the dryer is paused or the dryer's drum rotates periodically.</p> <ul style="list-style-type: none"> • Turn off the appliance and unload the all of the laundries from the appliance. |

Operation

| Symptoms | Possible Cause & Solution |
|---|---|
| Appliance will not turn on. | <p>Power cord is not properly plugged in.</p> <ul style="list-style-type: none"> • Make sure that the power plug is securely plugged into a grounded outlet matching the appliance's rating plate. |
| | <p>House fuse is blown, circuit breaker has tripped, or power outage has occurred.</p> <ul style="list-style-type: none"> • Reset circuit breaker or replace fuse. Do not increase fuse capacity. If the problem is a circuit overload, have it corrected by a qualified electrician. |
| Appliance does not heat. | <p>House fuse is blown, circuit breaker has tripped, or power outage has occurred.</p> <ul style="list-style-type: none"> • Reset circuit breaker or replace fuse. Do not increase fuse capacity. If the problem is a circuit overload, have it corrected by a qualified electrician. |
| | <p>Selected cycle does not use heat.</p> <ul style="list-style-type: none"> • Some cycles default to unheated or air drying. Select a cycle that allows heated drying. |
| Water leaks. | <p>The optional drain hose is not connected correctly.</p> <ul style="list-style-type: none"> • Connect the optional drain hose correctly. |
| | <p>The door is closed while clothes or foreign substance is caught in the door.</p> <ul style="list-style-type: none"> • Check if clothes or foreign substance is caught in the door before using the appliance. If water leaks continuously, contact the LG Electronics Customer Information Centre. |
| Appliance runs and pauses by itself after the drying cycle finishes. | <p>This is how the anti crease option works.</p> <ul style="list-style-type: none"> • Make sure that the anti crease option has been set. The option is designed to prevent creases that are formed when the clothes are not unloaded promptly after the drying cycle. When the option is set, the appliance runs for 10 seconds and pauses for 5 minutes. The option is works for up to 2 hours. |

72 TROUBLESHOOTING

Performance

| Symptoms | Possible Cause & Solution |
|--|---|
| <p>Clothes take too long to dry.</p> | <p>Load is not properly sorted.</p> <ul style="list-style-type: none"> Separate heavy items from lightweight items. Larger and heavier items take longer to dry. Light items in a load with heavy items can fool the sensor because the light items dry faster. |
| | <p>Large load of heavy fabrics.</p> <ul style="list-style-type: none"> Heavy fabrics take longer to dry because they tend to retain more moisture. To help reduce and maintain more consistent drying times for large and heavy fabrics, separate these items into smaller loads of a consistent size. |
| | <p>Appliance controls are not set properly.</p> <ul style="list-style-type: none"> Use the appropriate control settings for the type of load you are drying. Some loads may require an adjustment of the dry level setting for proper drying. |
| | <p>Lint filter needs to be cleaned.</p> <ul style="list-style-type: none"> Remove the lint from the lint filter after every cycle. With the lint removed, hold the lint filter up to a light to see if it is dirty or clogged. With some loads that produce high amounts of lint, such as new bath towels, it may be necessary to pause the cycle and clean the filter during the cycle. |
| | <p>House fuse is blown, circuit breaker has tripped, or power outage has occurred.</p> <ul style="list-style-type: none"> Reset circuit breaker or replace fuse. Do not increase fuse capacity. If the problem is a circuit overload, have it corrected by a qualified electrician. |
| | <p>Appliance is overloaded.</p> <ul style="list-style-type: none"> Divide extra large loads into smaller loads for better drying performance and efficiency. |
| | <p>Dryer is a heat-pump model.</p> <ul style="list-style-type: none"> Heat-pump dryer models can take longer to dry clothes. However, compared to a conventional dryer, where the heater uses much more energy than the drum motor, a heat-pump dryer uses a more efficient heat exchanger and will generally use less energy overall, even during long cycles. |
| <p>Drying time is not consistent.</p> | <p>Heat settings, load size, or dampness of clothing is not consistent.</p> <ul style="list-style-type: none"> The drying time for a load will vary depending on the type of heat used (electric), the size of the load, the type of fabrics, the wetness of the clothes, and lint filter. Even an unbalanced load in the appliance can cause poor spinning, resulting in wetter clothes which will take longer to dry. |
| <p>Greasy or dirty spots are left on clothes.</p> | <p>Fabric softener is used incorrectly.</p> <ul style="list-style-type: none"> When washing clothes that are to be dried in the appliance, use the correct amount of fabric softener as recommended by the manufacturer of the fabric softener. |

| Symptoms | Possible Cause & Solution |
|---|--|
| Greasy or dirty spots are left on clothes. | Clean and dirty clothes are being dried together. <ul style="list-style-type: none"> Use the appliance to dry only clean items. Soil from dirty clothes can transfer to the clean clothes in the same or later loads. |
| | Clothes were not properly cleaned or rinsed before being placed in the appliance. <ul style="list-style-type: none"> Stains on dried clothes could be stains that were not removed during the washing process. Make sure that clothes are being completely cleaned or rinsed according to the instructions for your washing machine and detergent. Some difficult soils may require pre-treating prior to washing. |
| Clothes are wrinkled. | Clothes have dried too long (overdried). <ul style="list-style-type: none"> Over drying a load of clothes can lead to wrinkled clothes. Try a shorter drying time. |
| | Clothes have been left in the appliance for too long after cycle ends. <ul style="list-style-type: none"> Use the Anti Crease option. |
| Clothes are shrinking. | Garment care instructions are not being followed. <ul style="list-style-type: none"> To avoid shrinking your clothes, always consult and follow fabric care instructions. Some fabrics will naturally shrink when washed. Other fabrics can be washed but will shrink when dried in the appliance. Use a low or no heat setting. |
| Lint is left on clothes. | Lint filter has not been cleaned properly. <ul style="list-style-type: none"> Remove the lint from the lint filter after every cycle. With the lint removed, hold the lint filter up to a light to see if it is dirty or clogged. If it looks dirty, follow the cleaning instructions. With some loads that produce high amounts of lint, it may be necessary to clean the lint filter during the cycle. |
| | Clothes have not been sorted properly. <ul style="list-style-type: none"> Some fabrics are lint producers (i.e., a fuzzy white cotton towel) and should be dried separately from clothes that are lint trappers (i.e., a pair of black linen pants). |
| | Appliance is overloaded. <ul style="list-style-type: none"> Divide extra large loads into smaller loads for drying. |
| | Tissue, paper, etc., has been left in pockets. <ul style="list-style-type: none"> Check pockets thoroughly before drying clothes. |
| Excess static in clothes after drying. | Clothes have dried for too long (overdried). <ul style="list-style-type: none"> Overdrying a load of clothes can cause a buildup of static electricity. Adjust settings and use a shorter drying time. |
| | Drying synthetics, permanent press, or synthetic blends. <ul style="list-style-type: none"> These fabrics are naturally more prone to static buildup. Try using fabric softener, or use shorter Timed Drying time settings. |

74 TROUBLESHOOTING

| Symptoms | Possible Cause & Solution |
|---|---|
| Clothes have damp spots after a Dry programme. | <p>Very large load or very small load. Single large item such as a blanket or comforter.</p> <ul style="list-style-type: none"> • If items are too tightly packed or too sparse the sensor may have trouble reading the dryness level of the load. Use a Timed Drying programme for very small loads. • Large, bulky items such as blankets or comforters can sometimes wrap themselves into a tight ball of fabric. The outside layers will dry and register on the sensors, while the inner core remains damp. When drying a single bulky item, it may help to pause the cycle once or twice and rearrange the item to unwrap and expose any damp areas. • To dry a few remaining damp items from a very large load or a few damp spots on a large item after a Dry programme has completed, empty the lint filter, then set a Timed Drying programme to finish drying the item(s). |

Odours

| Symptoms | Possible Cause & Solution |
|---|--|
| The appliance has an unpleasant odour. | <p>Are you using the appliance for the first time?</p> <ul style="list-style-type: none"> • The odour is caused by the rubber material inside the appliance. The odour normal when the appliance is new and disappears after you run several cycles. |
| | <p>Do you smell an odour during use?</p> <ul style="list-style-type: none"> • Do not exceed the manufacturer's recommended amount of detergent when washing clothes. Excess detergent can build up on clothing and cause odours. • Leaving clothes in the washer or dryer after the cycle ends can lead to odours. Unload clothing promptly when the cycle ends. • For ventless models, leave the dryer door open after drying, or use the magnetic door stop (on some models) to keep the door slightly ajar. • If the odour is coming from the washer, follow the instructions in the product manual to clean the washer tub/drum. • Keep both lint filters clean. Clogged or dirty lint filters can cause odours. After cleaning the lint filter, allow it to dry completely before using it. • Periodically run the Drum Care and Condenser Care cycles following the instructions in the MAINTENANCE section. |

Common

Wi-Fi

| Symptoms | Possible Cause & Solution |
|--|--|
| <p>Your home appliance and smartphone are not connected to the Wi-Fi network.</p> | <p>The password for the Wi-Fi that you are trying to connect to is incorrect.</p> <ul style="list-style-type: none"> Find the Wi-Fi network connected to your smartphone and remove it, then register your appliance on LG ThinQ. |
| | <p>Mobile data for your smartphone is turned on.</p> <ul style="list-style-type: none"> Turn off the Mobile data of your smartphone and register the appliance using the Wi-Fi network. |
| | <p>The wireless network name (SSID) is set incorrectly.</p> <ul style="list-style-type: none"> The wireless network name (SSID) should be a combination of English letters and numbers. (Do not use special characters). |
| | <p>The router frequency is not 2.4 GHz.</p> <ul style="list-style-type: none"> Only a 2.4 GHz router frequency is supported. Set the wireless router to 2.4 GHz and connect the appliance to the wireless router. To check the router frequency, check with your internet service provider or the router manufacturer. |
| | <p>The distance between the appliance and the router is too far.</p> <ul style="list-style-type: none"> If the distance between the appliance and the router is too far, the signal may be weak and the connection may not be configured correctly. Move the location of the router so that it is closer to the appliance. |

ENGLISH

76 APPENDIX

APPENDIX

Product Fiche

Commission Delegated Regulation (EU) No 392/2012

Asterisk(s) means model variant and can be varied from (0-9), (A-Z) or blank space.

| LG | WT1210***** |
|---|----------------------------------|
| Rated capacity in kg of cotton laundry for the standard cotton programme at full load | 10 kg |
| Dryer type | Condenser Household Tumble Dryer |
| Energy efficiency class on a scale from D (least efficient) to A+++ (most efficient). | A+++ |
| Weighted annual energy consumption (AEC) kWh per year (kWh/year)*1 | 211 |
| Automatic tumble drier | Yes |
| Awarded an "EU Ecolabel award" under regulation (EC) No 66/2010 | No |
| Energy consumption of the standard cotton programme at full load (E _{dry}) (kWh) | 1.79 |
| Energy consumption of the standard cotton programme at partial load (E _{dry1/2}) (kWh) | 0.92 |
| Power consumption of the off-mode for the standard cotton programme at full load (P _o) (W) | 0.49 |
| Power consumption of the left-on mode for the standard cotton programme at full load (P _l) (W) | 0.49 |
| Duration of the left-on mode (T _l) (min) | 10 |
| The Cotton  → Cupboard → Energy used at full and partial load is the standard drying programme to which the information in the label and the fiche relates, that this programme is suitable for drying normal wet cotton laundry and that it is the most efficient programme in terms of energy consumption for cotton. | |
| The weighted programme time (T _l) of the standard cotton programme at full and partial load (min) | 220 |
| The programme time of the standard cotton programme at full load (T _{dry}) (min) | 299 |
| The programme time of the standard cotton programme at partial load (T _{dry1/2}) (min) | 160 |

| LG | WT1210***** |
|---|-------------|
| Condensation efficiency class X on a scale from G (least efficient) to A (most efficient) | A |
| Average condensation efficiency C_{dry} of the standard cotton programme at full load (%) | 91 |
| Average condensation efficiency $C_{dry1/2}$ of the standard cotton programme at partial load (%) | 91 |
| The weighted condensation efficiency (C_t) for the standard cotton programme at full and partial load (%) | 91 |
| The sound power level in dB(A) | 62 |
| Free-Standing | |

*1 Based on 160 standard drying cycles for cotton programmes at full and partial load, and the consumption of the low-power modes. Actual energy consumption will depend on how the appliance is used.

Memo

Memo

Memo

Memo

Memo

Memo

