



User Guide

Quality, Design and Innovation





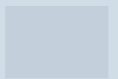















[home.liebherr.com/fridge-manuals](http://home.liebherr.com/fridge-manuals)







# LIEBHERR



# Contents

|   |  |          |
|---|--|----------|
| <b>1</b>  | <b>Appliance at a glance.....</b>            | <b>3</b> |
| 1.1   | Scope of delivery.....                       | 3        |
| 1.2   | Overview of the appliance and equipment..... | 3        |
| 1.3   | Appliance range of use.....                  | 3        |
| 1.4   | Conformity.....                              | 4        |
| 1.5   | EPREL database.....                          | 4        |
| <b>2</b>  | <b>General safety instructions.....</b>      | <b>4</b> |
| <b>3</b>  | <b>Putting into operation.....</b>           | <b>5</b> |
| 3.1   | Switching on appliance.....                  | 5        |
| 3.2   | Inserting the components.....                | 6        |
| <b>4</b>  | <b>Foods management.....</b>                 | <b>6</b> |
| 4.1   | Storing food.....                            | 6        |
| 4.2   | Storage times.....                           | 7        |
| <b>5</b>  | <b>Saving energy.....</b>                    | <b>7</b> |
| <b>6</b>  | <b>Controls.....</b>                         | <b>7</b> |
| 6.1   | Controls and displays.....                   | 7        |
| 6.1.1   | Status display.....                          | 7        |
| 6.1.2   | Navigation.....                              | 7        |
| 6.1.3   | Operating structure.....                     | 7        |
| 6.1.4   | Display symbols.....                         | 8        |
| 6.2   | Control concept.....                         | 8        |
| 6.2.1   | Activating/deactivating the function.....    | 8        |
| 6.2.2   | Selecting function value.....                | 8        |
| 6.2.3   | Activating/deactivating settings.....        | 8        |
| 6.2.4   | Selecting the setting value.....             | 9        |
| 6.2.5   | Go to the Customer menu.....                 | 9        |
| 6.3   | Functions.....                               | 9        |
|   | Temperature.....                             | 9        |
|  | SuperFrost.....                              | 9        |
|  | PartyMode.....                               | 10       |
|  | E-Saver.....                                 | 10       |
|  | IceMaker*.....                               | 10       |
|  | MaxIce*.....                                 | 10       |
| 6.4   | Settings.....                                | 10       |
|  | Connecting to the WLAN.....                  | 10       |
|  | Entry lock.....                              | 11       |
|  | Display brightness.....                      | 11       |
|  | Door alarm.....                              | 11       |
|  | Temperature unit.....                        | 11       |
|  | Info.....                                    | 11       |
|  | SabbathMode.....                             | 11       |
|  | TubeClean*.....                              | 12       |
|  | Ice cubes*.....                              | 12       |
|  | Reminder.....                                | 12       |

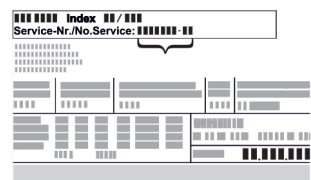
|   |   |           |
|---|---|-----------|
|  | Reset.....  | 12        |
|  | Turn off appliance.....   | 12        |
| 6.5   | Fault messages.....   | 12        |
| 6.5.1   | Warnings.....   | 12        |
| 6.5.2   | Message.....  | 13        |
| 6.5.3   | DemoMode.....   | 13        |
| <b>7</b>  | <b>Features.....</b>  | <b>13</b> |
| 7.1   | Drawers.....  | 13        |
| 7.2   | Pull-out board with IceTower*.....                                    | 14        |
| 7.3   | Glass shelves.....  | 15        |
| 7.4   | EasyTwist-Ice*.....   | 15        |
| 7.5   | IceMaker*.....  | 16        |
| 7.6   | VarioSpace.....   | 16        |
| 7.7   | Accessories.....  | 16        |
| <b>8</b>  | <b>Maintenance.....</b>   | <b>17</b> |
| 8.1   | Disassembling / assembling pull-out systems.....                      | 17        |
| 8.2   | Drawer on moulded rib.....  | 17        |
| 8.3   | IceTower*.....  | 17        |
| 8.4   | Defrosting the appliance.....   | 18        |
| 8.5   | Cleaning the appliance.....   | 18        |
| <b>9</b>  | <b>Customer help.....</b>   | <b>20</b> |
| 9.1   | Technical specifications.....   | 20        |
| 9.2   | Operating noises.....   | 20        |
| 9.3   | Technical fault.....  | 21        |
| 9.4   | Customer Services.....  | 22        |
| 9.5   | Model plate.....  | 22        |
| <b>10</b>   | <b>Shutting down.....</b>   | <b>22</b> |
| <b>11</b>   | <b>Disposal.....</b>  | <b>22</b> |
| 11.1  | Preparing appliance for disposal.....                                 | 22        |
| 11.2  | Disposing of the appliance in an environmentally friendly manner..... | 22        |

The manufacturer is continually working on the further development of all types and models. Please be aware that we reserve the right to make changes to the shape, equipment and technology.

| Symbol  | Explanation  |
|---|--|
|  | <p><b>Read instructions</b></p> <p>Please read the information in these instructions carefully to understand all of the benefits of your new appliance.</p>  |
|  | <p><b>Full instructions on the internet</b></p> <p>You can find detailed instructions on the internet using the QR code on the front of these instruction or by entering the service number at <a href="http://home.liebherr.com/fridge-manuals">home.liebherr.com/fridge-manuals</a>.</p> <p>The service number can be found on the serial tag:</p> <div style="text-align: center;">  </div> <p style="text-align: right;"><i>Fig. Example illustration</i></p> |
|  | <p><b>Check appliance</b></p> <p>Check all parts for transport damage. If you have any complaints, please contact your agent or customer service.</p>  |

| Symbol   | Explanation   |
|--|---|
|  | <b>Differences</b><br>These instructions apply to a range of models, so differences are possible. Sections that apply to certain models only are marked with an asterisk (*). |
|  | <b>Instructions and results</b><br>Instructions are marked with a ▶.<br>Results are marked with a ▷.  |
|  | <b>Videos</b><br>Videos about the appliances are available on the YouTube channels of Liebherr-Hausgeräte.  |

These operating instructions apply to:

|                  |                             |
|------------------|-----------------------------|
| FN d/e/f         | 42/46/50/52...              |
| FN c/d           | 66/70/72...                 |
| FN sf e          | 5227                        |
| SFN (bd/sd/sf) e | 52...                       |
| GNeu             | 1460-e                      |
| LTGN-234         |                             |
| GN               | 4Z2fa4/4Z6fa5/5Z0fa6/5Z2fa7 |

### Note

If your appliance has an N in its appliance designation, it is a NoFrost appliance.

## 1 Appliance at a glance

### 1.1 Scope of delivery

Check all parts for damage during transport. If you have any complaints, please contact your retailer or Customer Services (see 9.4 Customer Services).

Your new appliance comes with the following parts:

- Standalone appliance
- Features (depending on the model)
- Installation materials (depending on the model)
- "Quick Start Guide"
- "Installation Guide"
- Service Brochure

### 1.2 Overview of the appliance and equipment

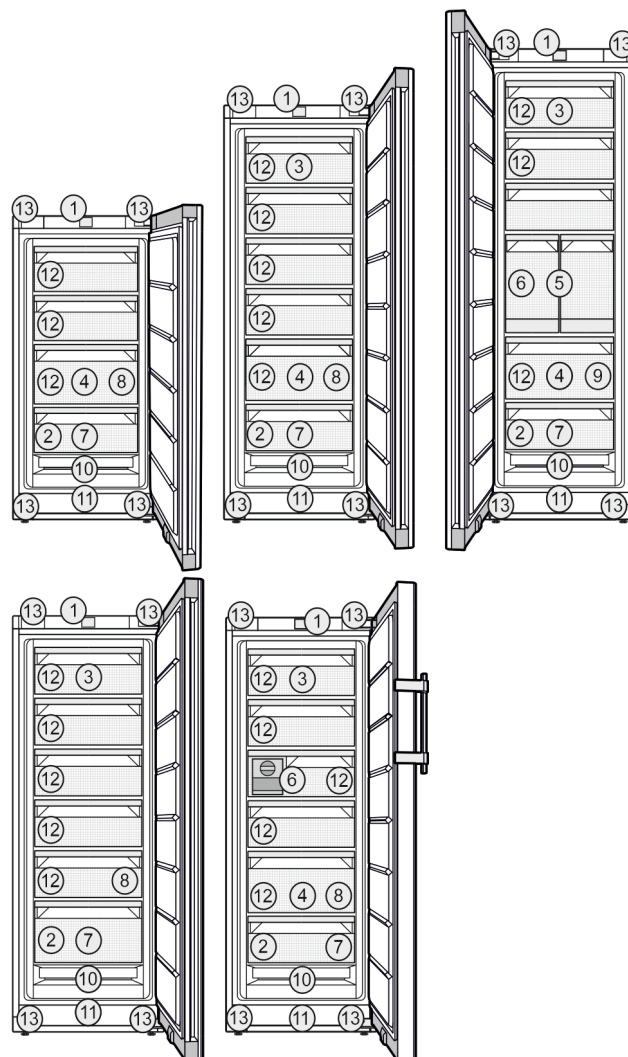

Fig. 1 Example illustration

#### Equipment

- |  |   |
|--|---|
| (1) Controls                                 | (8) Ice cube tray*  |
| (2) Type plate                               | (9) Ice cube scoop*   |
| (3) Tilting drawer*                          | (10) NoFrost  |
| (4) SpaceBox*                                | (11) Ventilation slit   |
| (5) IceTower*                                | (12) VarioSpace   |
| (6) IceMaker* / EasyTwist-Ice*               | (13) Adjustable feet (front), transport castors (rear), transport handles at the top (rear) and at the bottom (front) |
| (7) Freezer tray*, cold storage accumulator* |   |

### Note

- ▶ Shelves, drawers and baskets are arranged for optimum energy efficiency when the appliance is delivered. Changing how the shelves, for example, are inserted in the fridge compartment does not have any impact on energy consumption.

### 1.3 Appliance range of use

#### Intended use

# General safety instructions

The appliance is only suitable for cooling food products in a domestic or household-like environment. This includes, for example, use:

- in staff kitchens, bed and breakfast establishments,
- by guests in country houses, hotels, motels and other accommodation,
- for catering and similar services in the wholesale trade.

The appliance is not suitable as a built-in unit.

All other types of use are not permitted.

## Foreseeable misuse

The following applications are expressly forbidden:

- Storing and refrigerating medicines, blood plasma, laboratory preparations or similar substances and products based on the Medical Device Directive 2007/47/EC
- Use in areas at risk of explosions

Misusing the appliance may lead to damage to the goods stored or they may spoil.

## Climate classifications

Depending on the climate classification the appliance is designed to operate in restricted ambient temperatures. The climate classification applying to your appliance is printed on the rating plate.

## Note

► Keep to the specified ambient temperatures in order to guarantee that the appliance works properly.

| Climate classification | for ambient temperatures |
|------------------------|--------------------------|
| SN, N                  | to 32 °C                 |
| ST                     | to 38 °C                 |
| T                      | to 43 °C                 |

If your appliance has a fixed water connection, then the appliance is guaranteed to function correctly down to a lower ambient temperature of 0 °C.\*

If your appliance does not have a fixed water connection, then the appliance is guaranteed to function correctly down to a lower ambient temperature of -15 °C.\*

## 1.4 Conformity

The refrigerant circuit has been tested for leaks. The appliance complies with the applicable safety regulations and with the corresponding directives.

The full text of the EU Declaration of Conformity is available on the following website: [www.Liebherr.com](http://www.Liebherr.com)

## 1.5 EPREL database

Details about energy labelling and ecodesign requirements will be available on the European product database (EPREL) from 1st March 2021. You can access the product database at the following link: <https://eprel.ec.europa.eu/> You will be asked to enter the model ID. You can find the model ID on the nameplate.

## 2 General safety instructions

Please keep these operating instructions in a safe place so you can refer back to them at any time.

If you pass the appliance on, please hand these operating instructions to the next user.

Read these operating instructions carefully before use to ensure safe and correct use of the appliance. Follow the instructions, safety instructions and warning messages included at all times. They are important for ensuring you can operate and install the appliance safely and without any problems.

### Danger for the user:

- This device can be used by children and people with impaired physical, sensory or mental abilities or with a lack of experience and knowledge provided that they are supervised or have received instruction in the safe use of this device, and about the resulting hazards. Children must not play with this appliance. Cleaning and user maintenance work must not be carried out by children without adult supervision. Children aged between 3 and 8 are allowed to load and unload the appliance. Children below the age of 3 must be kept away from the appliance unless they are under continuous adult supervision.
- The socket must be easily accessible so that the appliance can be disconnected quickly from the electricity in an emergency. It must not be located in the area behind the appliance.
- When disconnecting the appliance from the supply, always take hold of the plug. Do not pull the cable.
- In the event of a fault pull out the mains plug or deactivate the fuse.
- Do not damage the mains power cable. Do not operate the appliance with a defective mains power cable.
- Only customer service or other specially trained staff may repair or perform other operations on the appliance.

- Only assemble, connect and dispose of the appliance according to the instructions.
- The manufacturer is not liable for damage caused by a faulty fixed water connection.\*

## Fire hazard:

- The coolant used (information on the model plate) is ecofriendly but also flammable. Any leaking coolant may ignite.
  - Do not damage the refrigerant circuit pipes.
  - Do not handle ignition sources inside the appliance.
  - Do not use electrical appliances inside the appliance (e.g. steam cleaners, heaters, ice cream makers, etc.).
  - If the refrigerant leaks: remove any naked flames or ignition sources from the vicinity of the leakage point. Properly air the room. Inform customer services.
- Do not store explosives or sprays using combustible propellants such as butane, propane, pentane, etc. in the appliance. To identify these spray cans, look for the list of contents printed on the can, or a flame symbol. Gases possibly escaping may ignite due to electrical components.
- Keep burning candles, lamps and other items with naked flames away from the appliance so that they do not set the appliance on fire.
- Please be sure to store alcoholic drinks or other packaging containing alcohol in tightly closed containers. Any alcohol that leaks out may be ignited by electrical components.

## Danger of tipping and falling:

- Do not misuse the plinth, drawers, doors etc. as a step or for support. This applies particularly to children.

## Danger of food poisoning:

- Do not consume food which has been stored too long.

## Danger of frostbite, numbness and pain:

- Avoid prolonged skin contact with cold surfaces or refrigerated/frozen goods or take protective measures, e.g wear gloves.

## Danger of injury and damage:

- Hot steam can lead to injury. Do not use electrical heating or steam cleaning equipment, open flames or defrosting sprays to defrost.
- Do not use sharp implements to remove the ice.

## Risk of crushing:

- Do not hold the hinge when opening and closing the door. Fingers may get caught.

## Symbols on the appliance:



This symbol may be located on the compressor. It relates to the oil in the compressor and makes reference to the risk that: Swallowing or inhaling can be fatal. This advice is only relevant to recycling. There is no danger in normal operation.



This symbol is located on the compressor and indicates the danger of flammable materials. Do not remove the sticker.



This or a similar sticker may be located on the rear of the appliance. It refers to the foam-padded panels in the door and/or the housing. This advice is only relevant to recycling. Do not remove the sticker.

## Please note the warning messages and other specific advice in the other chapters:

|  |         |   |
|--|---------|---|
|  | DANGER  | indicates an immediately hazardous situation which will lead to death or serious injuries if it is not avoided. |
|  | WARNING | indicates a hazardous situation which may lead to death or serious injuries if it is not avoided.               |
|  | CAUTION | indicates a hazardous situation which may lead to minor or moderate injuries if it is not avoided.              |
|  | NOTICE  | indicates a hazardous situation which may lead to damage to property if it is not avoided.                      |
|  | Note    | indicates useful instructions and tips.   |

## 3 Putting into operation

### 3.1 Switching on appliance

Ensure that the following conditions are met:

- Appliance is set up and connected according to installation instructions.
- All adhesive strips, adhesive and protective films as well as transport safety devices in and on the appliance are removed.
- All marketing leaflets are removed from the drawers.

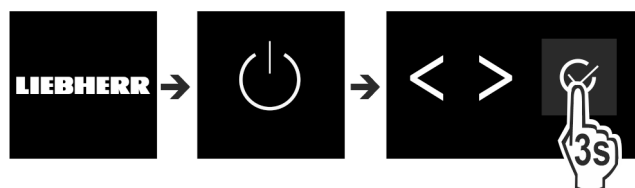

Fig. 2

- Switch on the appliance using the control panel next to the display.

# Foods management

▷ The status display appears.

## The appliance starts in DemoMode:

If the appliance starts in DemoMode, you can deactivate DemoMode within the next 5 minutes.

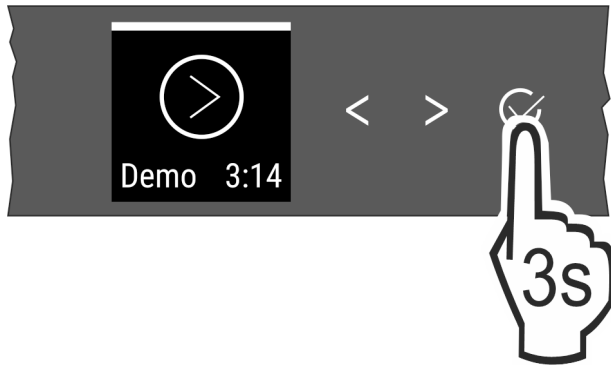

Fig. 3

- ▶ Press Confirm next to the display for 3 seconds.
- ▷ DemoMode is deactivated.

### Note

The manufacturer recommends:

- ▶ **Store frozen foods** at -18 °C or colder.

## 3.2 Inserting the components

- ▶ Insert the supplied components to make the most of your appliance.
- ▶ Purchase and install the SmartDevice Box (see [smartdevice.liebherr.com](http://smartdevice.liebherr.com)).
- ▶ Install the SmartDevice app (see [apps.home.liebherr.com](http://apps.home.liebherr.com)).

### Note

You can purchase accessories from the [Liebherr household appliance store](http://Liebherr household appliance store) ([home.liebherr.com](http://home.liebherr.com)).

# 4 Foods management

## 4.1 Storing food



### WARNING

Risk of fire

- ▶ Do not use any electrical appliances in the food area of the appliance unless recommended by the manufacturer.

### Note

The energy consumption increases and the cooling power goes down if ventilation is not sufficient.

- ▶ Always keep air slots clear.

When storing food, always observe the following:

- Air vents on the inside rear wall are unobstructed.
- Air vents on the fan are unobstructed.
- Food is in sealed packaging.
- Raw meat and fish are in clean, sealed containers to prevent them coming into contact with or dripping onto other foods.
- Foods are not stored too closely together, as the air needs to circulate.

### Note

Failure to follow these guidelines can lead to food perishing.

### 4.1.1 Freezer compartment

This provides a dry, frosty storage climate at -18 °C. A frosty climate is great for storing frozen food and frozen goods for several months, making ice cubes and freezing fresh food.

#### Freezing food

You can freeze as many kilograms of fresh food within 24 hours as indicated on the nameplate (see 9.5 Model plate) under "freezing capacity ... kg/24h".

So that the food is rapidly frozen through to the core, keep to the following quantities per pack:

- Fruit, vegetables up to 1 kg
- Meat up to 2.5 kg

Before freezing goods, please make sure of the following:

- SuperFrost is activated (see 6.3 Functions) when the amount of food to freeze exceeds approx. 2 kg.
- With a small amount of frozen goods: SuperFrost is activated approx. 6 hours prior.
- With the maximum amount of frozen goods: SuperFrost is activated approx. 24 hours prior.

#### Arrange your food as follows:



### CAUTION

Risk of injury from glass fragments!

Drink bottles and cans may explode if frozen. This applies particularly to carbonated drinks.

- ▶ Only freeze drink bottles and cans when using the *bottle timer* function.

With a small amount of frozen goods:

- ▶ Place packaged groceries in the top drawer.
- ▶ If possible, place groceries at the back of the drawer near the rear wall.

With a maximum amount of frozen goods:

- ▶ Distribute packaged groceries across all drawers, but do not place any groceries in the bottom drawer.
- ▶ If possible, place groceries at the back of the drawer near the rear wall.

With a maximum amount of frozen goods:

- ▶ Once SuperFrost deactivates automatically, place food into the drawer.

#### Defrost the food

- In the fridge
- In the microwave
- In the stove/oven
- At room temperature



### WARNING

Risk of food poisoning!

- ▶ Do not re-freeze thawed food.

- ▶ Only take out the food you need at the time.
- ▶ Cook defrosted food as soon as possible.

#### Freezer tray\*

Use the freezer tray for berries, herbs, vegetables and other small goods without them freezing together in the process. The food keeps its shape and is easier to separate into portions later on.

You can also store the freezer packs in the freezer tray to save space.\*

- ▶ Spread food, unsealed, at a good distance apart, over the whole surface of the freezer tray.

## 4.2 Storage times

Refer to the specified storage times as a guide.

In the case of foods with a minimum shelf life, the date indicated on the packaging still applies.

| Recommended storage period for various types of food |           |                |
|--|-----------|----------------|
| Ice cream  | at -18 °C | 2 to 6 months  |
| Sausages, ham  | at -18 °C | 2 to 3 months  |
| Bread, baked goods                                   | at -18 °C | 2 to 6 months  |
| Game, pork   | at -18 °C | 6 to 9 months  |
| Fatty fish   | at -18 °C | 2 to 6 months  |
| Lean fish  | at -18 °C | 6 to 8 months  |
| Cheese   | at -18 °C | 2 to 6 months  |
| Poultry, beef  | at -18 °C | 6 to 12 months |
| Vegetables, fruit                                    | at -18 °C | 6 to 12 months |

## 5 Saving energy

- Pay attention to good ventilation. Do not cover ventilation holes or grids.
- Always keep the fan air slits clear.
- Do not install the appliance in direct sunlight, next to an oven, radiator or similar.
- Energy consumption depends on the installation conditions, e.g. the ambient temperature (see 1.3 Appliance range of use) . A warmer ambient temperature can increase the energy consumption.
- Open the appliance for as short a time as possible.
- The lower the temperature is set the higher the energy consumption.
- Keep all food properly packed and covered. This prevents frost from forming.
- Inserting warm food: allow to cool down to room temperature first.

## 6 Controls

### 6.1 Controls and displays

The display provides a quick overview of the temperature setting and the status of functions and settings. You can control the functions and settings either by deactivating/activating them or by selecting a value.

#### 6.1.1 Status display



Fig. 4

(1) Temperature display

The Status display shows the set temperature and is the home display. From there, you can navigate to the options and settings.

#### 6.1.2 Navigation

Navigate in the menu to access the individual functions. An audible signal sounds after confirming a function or

setting. If no selection is made after 10 seconds the display switches to the Status display.

The appliance is operated with the buttons next to the display.



Fig. 5

(1) Navigation arrow left/right (2) Confirm

#### Navigation arrow left/right Fig. 5 (1):

- Navigating in the menu. After the last menu page, it goes back to the first one.

#### Confirm Fig. 5 (2):

- Activating/deactivating a function.
- Open a submenu.
- Confirm a selection. After confirmation the display switches back to the menu.

#### Back to Status display: in the fastest manner:

- Close and open the door.
- or wait 10 seconds. The display switches to the Status display.

### 6.1.3 Operating structure

The controls are explained by a template. The display changes depending on the function or settings.

#### Menus without a submenu

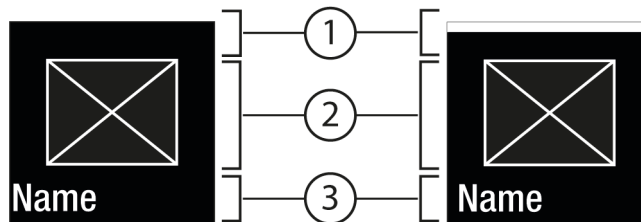

Fig. 6

(1) Status deactivated / status activated white bar in the top area

(2) Symbol or activated value

(3) Menu: Function name or menu: Setting name

# Controls

## Menus with a submenu

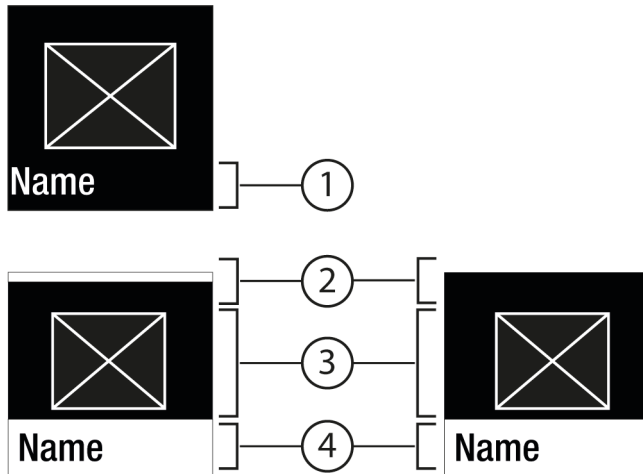

Fig. 7

- (1) Menu: Function name or menu: Setting name
- (2) Status
- (3) Symbol or activated value
- (4) Submenu: function name or submenu: Setting name

(2) off / on

You can navigation as follows:

- Press the left/right Fig. 5 (1) arrow to navigate.
- Press Confirm Fig. 5 (2) to open the submenu Fig. 7 (4).
  - Press the left/right Fig. 5 (1) arrow to navigate.
  - Set a new value: Press Confirm Fig. 5 (2) to select an active value Fig. 6 (1).
  - Back to the menu: Press Confirm Fig. 5 (2) to select the active value Fig. 6 (2).

### 6.1.4 Display symbols

Display symbols provide information on the current appliance status:

| Symbol | Appliance status  |
|--------|---|
|        | <b>Standby</b><br>The appliance or temperature zone is switched off.                                |
|        | <b>Flashing number</b><br>Appliance is working. Temperature flashes until the set value is reached. |
|        | <b>Flashing symbol</b><br>Appliance is working. Setting is made.                                    |
|        | <b>Bar grows steadily</b><br>Function is activated.   |

## 6.2 Control concept

### 6.2.1 Activating/deactivating the function

You can activate/deactivate the following functions:

| Symbol | Function                |
|--------|-------------------------|
|        | SuperFrost <sup>x</sup> |

| Symbol | Function                          |
|--------|-----------------------------------|
|        | IceMaker and MaxIce <sup>**</sup> |
|        | PartyMode <sup>x</sup>            |
|        | E-Saver                           |

<sup>x</sup> When function is on, the appliance works harder. This means appliance noise when operating may be louder for a short while, and more energy will be consumed.

- ▶ Press the navigation arrows Fig. 5 (1) repeatedly until the function is displayed.
- ▶ Press Confirm Fig. 5 (2).
- ▷ You hear the confirmation tone.
- ▷ Status appears in the menu.
- ▷ Function is on/off.

### 6.2.2 Selecting function value

With the following functions you can set a value in the submenu:

| Symbol | Function                    |
|--------|-----------------------------|
|        | Setting the temperature     |
|        | Switch the appliance on/off |

- ▶ Tap the navigation arrows Fig. 5 (1) repeatedly until the function is displayed.
- ▶ Press Confirm Fig. 5 (2).
- ▶ Select the setting value with the navigation arrows Fig. 5 (1).

#### Setting the temperature

- ▶ Press Confirm Fig. 5 (2).
- ▷ You hear the confirmation tone.
- ▷ Status: On Fig. 6 (1) appears briefly in the submenu Fig. 7 (4).
- ▷ Display switches back to the menu.

### 6.2.3 Activating/deactivating settings

You can activate/deactivate the following settings:

| Symbol | Setting                  |
|--------|--------------------------|
|        | WiFi <sup>1</sup>        |
|        | Entry lock <sup>2</sup>  |
|        | SabbathMode <sup>2</sup> |
|        | Reminders <sup>1</sup>   |
|        | Reset <sup>2</sup>       |
|        | Off <sup>2</sup>         |

- ▶ Tap the navigation arrows Fig. 5 (1) repeatedly until the settings appear.
- ▶ Press Confirm Fig. 5 (2).
- ▶ Tap the navigation arrows Fig. 5 (1) repeatedly until the desired setting is displayed.

## <sup>1</sup> Activate setting (shortpress)



- ▶ Press Confirm Fig. 5 (2).
- ▷ You hear the confirmation tone.
- ▷ Status appears in the menu.
- ▷ Setting is on / off.

## <sup>2</sup> Activate setting (longpress)

- ▶ To Confirm Fig. 5 (2), press for 3 seconds.
- ▷ You hear the confirmation tone.
- ▷ Status appears in the menu.
- ▷ Display changes.

### 6.2.4 Selecting the setting value



With the following settings you can set a value in the submenu:



| Symbol   | Settings   |
|--|------------|
|  | Brightness |
|  | Door alarm |
|  | Temp. unit |

- ▶ Tap the navigation arrows Fig. 5 (1) repeatedly until settings  appears.
- ▶ Press Confirm Fig. 5 (2).
- ▶ Tap the navigation arrows Fig. 5 (1) repeatedly until the desired setting is displayed.
- ▶ Press Confirm Fig. 5 (2).
- ▶ Select the setting value with the navigation arrows Fig. 5 (1).
- ▶ Press Confirm Fig. 5 (2).
- ▷ You hear the confirmation tone.
- ▷ Status appears briefly in the submenu.
- ▷ Display switches back to the menu.

### 6.2.5 Go to the Customer menu

You can see the following settings in the Customer menu:

| Symbol   | Function                |
|--|-------------------------|
|  * | TubeClean <sup>2*</sup> |
|  * | Ice cubes <sup>1*</sup> |
|    | Software                |

- ▶ Press the navigation arrows Fig. 5 (1) repeatedly until the settings  appear.
- ▶ Press Confirm Fig. 5 (2).
- ▶ Press the navigation arrows Fig. 5 (1) repeatedly until the appliance information  appears in the display.
- ▶ Press Confirm Fig. 5 (2).
- ▶ Enter the numerical code 151.
- ▷ The customer menu appears.
- ▶ Press the navigation arrows Fig. 5 (1) repeatedly in the customer menu until the desired setting appears.

#### <sup>1</sup> Select the value

- ▶ Press Confirm Fig. 5 (2).
- ▷ You hear the confirmation tone.
- ▷ Status appears briefly in the display.
- ▷ Display switches back to the menu.

#### <sup>2</sup> Activate the setting

- ▶ To Confirm Fig. 5 (2), press for 3 seconds.



- ▷ You hear the confirmation tone.
- ▷ Status appears on the display.
- ▷ The symbol flashes as long as the appliance is working.

## 6.3 Functions

### Temperature

The temperature depends on the following factors:

- The amount of times the door is opened
- How long the door is open for
- The room temperature of the installation site
- The type, temperature and amount of food

| Freezer compartment  | Recommended setting |
|--|---------------------|
|  -18 °C | -18 °C              |
|  -18 °C |                     |

#### Setting the temperature

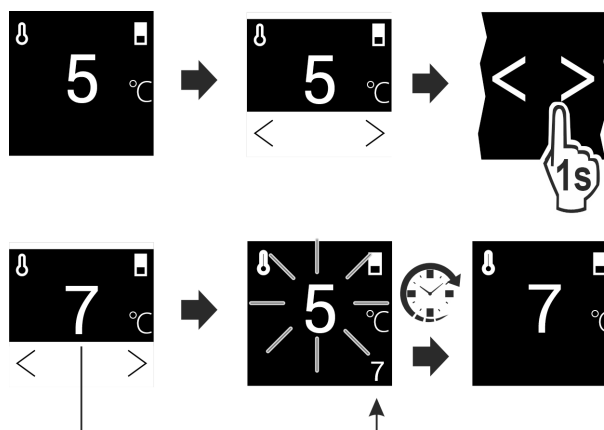

Fig. 8

- ▶ Set the value. (see 6.2 Control concept) .
- ▷ Set temperature is shown at the bottom right of the display.

### SuperFrost

This function selects the lowest freezing temperature. This gives you colder storage temperatures.

Use:

- For storing more than 2 kg fresh food every day.
- Freezing fresh food quickly to the core.
- Increasing the cold reserves in the stored goods before defrosting the appliance.

#### Activating/deactivating the function

- With a small amount to freeze:
  - ▶ Activate 6 hours before use.
- With a maximum amount to freeze:
  - ▶ Activate 24 hours before use.
  - ▶ Activating/deactivating (see 6.2 Control concept) .

The function automatically turns off. The appliance goes back to normal mode. The temperature adjusts itself to the set level.

# Controls



## PartyMode

This option offers an assortment of special functions and settings that are useful if you are having a party.

The following functions are on:

- SuperFrost
- IceMaker and MaxIce\*

All the functions can be adjusted flexibly and separately. Changes are discarded when the function turns off.

### Activating/deactivating the function

- ▶ Activating/deactivating (see 6.2 Control concept) .
- ▷ On: All functions are activated at the same time.
- ▷ Deactivated: Previously set temperatures are restored.

After 24 hours the function turns off automatically.



## E-Saver

This function reduces energy consumption. If you activate this function, the cooling temperature increases.

| Temperature zone | Recommended setting (see Temperature) | Temperature when E-Saver activated |
|------------------|---------------------------------------|------------------------------------|
| -18 °C           | -18 °C                                | -16 °C                             |

Use:

- Save energy.

### Activating/deactivating the function

- ▶ Activating/deactivating (see 6.2 Control concept) .
- ▷ Activated: Higher temperatures are set in all temperature zones.
- ▷ Deactivated: Previously set temperatures are restored.



## IceMaker\*

This function creates ice cubes.\*

Use:\*

- Producing ice cubes

The ice cube size can be set with the **ice cube** function. (see Ice cubes\*) \*

You can increase the number of ice cubes produced with the **MaxIce** function. (see MaxIce\*) \*

The lines can be cleaned with the **TubeClean** function. (see TubeClean\*) \*

### Activating the function\*

Ensure that the following conditions are met:

- The water supply is established at the fixed water connection. See installation instructions.\*
- IceMaker is put into operation. (see 7.5 IceMaker\*)
- ▶ Activate the function. (see 6.2 Control concept)
- ▷ It can take up to 24 hours for the first ice cubes to be made.

### Deactivating the function\*

- ▶ Deactivate the function. (see 6.2 Control concept)
- ▷ If ice cubes are currently being made, the system completes the process. After that, the IceMaker switches off.



## MaxIce\*

Using the MaxIce function, ice cubes can quickly be produced at 1.5 kg / 24 h.\*

Use:\*

- To make a lot of ice cubes very quickly.

### Activating/deactivating the function\*

- ▶ Activating/deactivating (see 6.2 Control concept) .

## 6.4 Settings



### Connecting to the WLAN

This setting connects the appliance to the internet. The connection is managed in the SmartDevice-Box. You can use the SmartDevice-App to add your appliance to a SmartHome-System. Use the SmartDevice-App or other compatible partner networks to enjoy advanced options and settings.

#### Note

The SmartDevice-Box is available from the [Liebherr Domestic Appliances Shop \(https://home.liebherr.com/shop/de/deu/smartdevicebox.html\)](https://home.liebherr.com/shop/de/deu/smartdevicebox.html).

You can find more information about the availability, prerequisites and the individual options on the Internet under <https://smartdevice.liebherr.com/install>.

Use:

- Manage the appliance with the SmartDevice-App or a compatible partner network.
- Enjoy advanced functions and settings.
- Check the current status of the appliance in the SmartDevice-App.

- The SmartDevice Box is purchased and installed (see <https://smartdevice.liebherr.com/install>).
- The SmartDevice app is installed (see <https://apps.home.liebherr.com/>).

### Setting up the connection

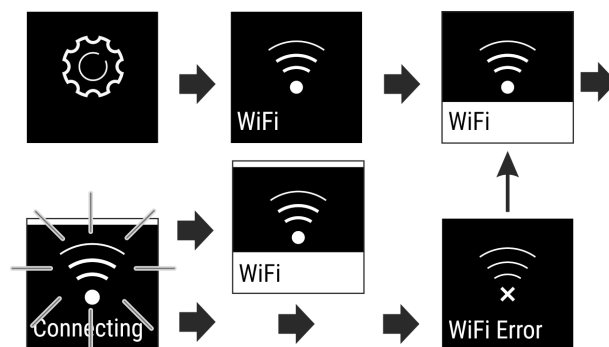

Fig. 9

- ▶ Activating the setting (see 6.2 Control concept) .
- ▷ The connection is set up: Status: on Fig. 6 (1) and WiFi connecting appears. The symbol flashes.
- ▷ The connection is set up: Status: on Fig. 6 (1) appears.
- ▷ The connection failed: Status and Connect appears. The symbol appears permanently.

### Disconnecting the appliance

- ▶ Deactivate the setting (see 6.2 Control concept) .

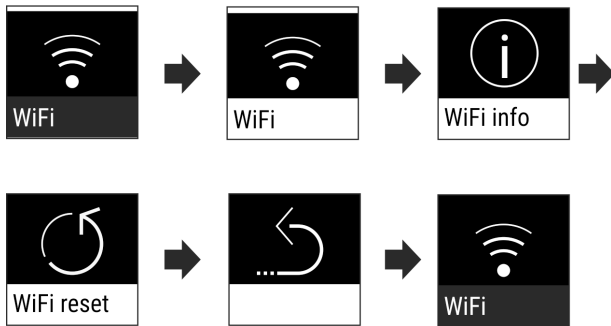



Fig. 10

There is no connection: The symbol  is displayed constantly.

## Restoring the connection

▶ Restore settings (see 6.2 Control concept) .

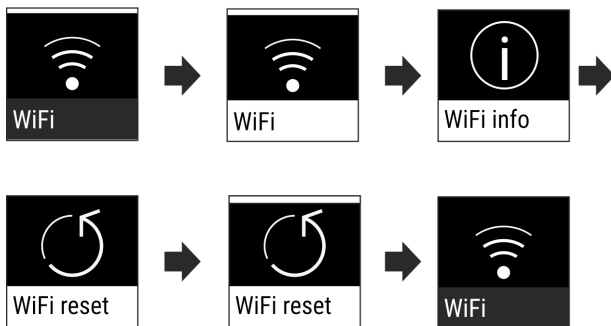

Fig. 11

▶ Connection and other settings are restored to factory settings.

## Entry lock

This setting prevents unintentional use of the appliance, e.g. by children.

Use:

- Avoid settings being changed unintentionally.
- Avoid the appliance being switched off unintentionally.
- Avoid the temperature being changed unintentionally.

## Activating/deactivating settings

▶ Activating/deactivating. (see 6.2 Control concept)



## Display brightness

Set the brightness level of the display.

You can set the following brightness levels:

- 40%
- 60%
- 80%
- 100%

## Choose the setting

▶ Set the level (see 6.2 Control concept) .

## Door alarm

Set the time before the door alarm (see Close the door) sounds.

The options are as follows:

- 1 min
- 2 min
- 3 min
- Off

## Choose the setting

▶ Set the time (see 6.5 Fault messages) .

## Temperature unit

This setting enables you to switch between Celsius and Fahrenheit as the temperature unit.

## Selecting the setting value

▶ Set the value (see 6.2 Control concept) .

## Info

This setting allows the appliance information to be read out as well as access to the customer menu.

It provides the following information:

- Model name
- Index
- Serial number
- Service number

## Show appliance data

- ▶ Tap the navigation arrows *Fig. 5 (1)* repeatedly until the  settings appear.
- ▶ Press Confirm *Fig. 5 (2)*.
- ▶ Tap the navigation arrows *Fig. 5 (1)* repeatedly until the information is displayed.
- ▶ Read the appliance info.

## SabbathMode

This setting meets the religious requirements on the Sabbath and Jewish festivals. Turn on SabbathMode to switch off certain controls. This means you can use the appliance without anyone changing the settings.

You can find a list of Star-K-certified appliances at [www.star-k.org/appliances](http://www.star-k.org/appliances).

This appliance has certification from the "Institute for Science and Halacha".

## WARNING

Danger of food poisoning.

If there is a power cut while the appliance is in SabbathMode, this message is not saved. Once power is restored, the appliance continues in SabbathMode. When this mode is over no message about the power cut is displayed on the temperature display.

If there was a power cut during SabbathMode:

- ▶ Check the food for quality. Do not eat the food if it has thawed.

What the appliance does in SabbathMode:

- The Status display continuously shows SabbathMode.

# Controls

- The display is locked for all functions apart from deactivating SabbathMode.
- Any functions/settings that are already on, remain active.
- The display stays bright when the door is closed.
- Reminders are disabled. The set time intervals are also paused. This function is disabled in SabbathMode.
- Reminders and warnings are not displayed. There are no acoustic signals, and the display does not show warnings or settings such as temperature alarm or door alarm.
- The IceMaker is out of use.\*
- The defrost cycle only works for the specified time without taking account of fridge use.
- After a power cut the appliance automatically returns to SabbathMode.

## Activating/deactivating SabbathMode

- ▶ To activate the function, click the arrows next to the display until you see Settings  in the menu and then confirm. The menu changes to show the available settings.
- ▶ Click the arrows next to the display until you see SabbathMode (Menora) appear. Confirm the symbol.
- ▷ A white bar appears in the top part of the display.
- ▷ SabbathMode is activated.

To deactivate this function, press the button for confirmation next to the display for 3 seconds.

SabbathMode is deactivated.



## TubeClean\*

This setting cleans the IceMaker pipes.\*

Ensure that the following conditions are met:\*

- IceMaker cleaning is ready (see 8.5.6 Cleaning the IceMaker\*).

## Activating the setting\*

- ▶ Activate the setting in the Customer menu (see 6.2 Control concept).
- ▷ The rinse process is ready (max. 60 min.): Symbol flashes.
- ▷ Water pipes are rinsed: Symbol flashes.
- ▷ Rinsing process is complete: Function turns off automatically.



## Ice cubes\*

Set the ice cube size.\*

## Choose the setting\*

- ▶ Set the size in the Customer menu (see 6.2 Control concept).



## Reminder

Reminders are given out acoustically by a beep and visually by a symbol in the display. The signal gets louder until the alert stops.

## Activating the setting

- ▶ Activating/deactivating (see 6.2 Control concept).



## Reset

This function resets all settings to the factory settings. All settings that you have made thus far will be reset to their original values.

## Activating the setting

- ▶ Activate (see 6.2 Control concept).



## Turn off appliance

This setting turns off the whole appliance.

## Switching off the entire appliance

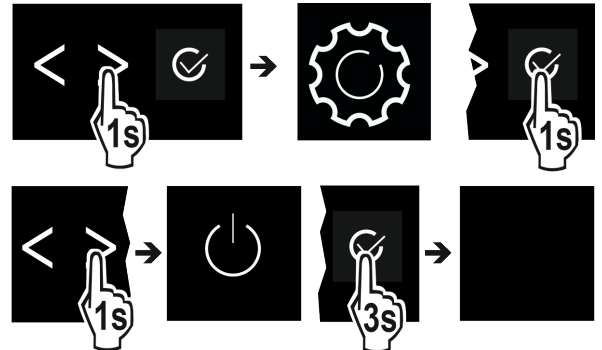

Fig. 12

- ▶ Turning off the IceMaker.\*
- ▶ Activating/deactivating (see 6.2 Control concept).
- ▷ Off: Display goes black.

## 6.5 Fault messages

Fault messages appear in the display. There are two categories of fault message:

| Category | Meaning  |
|----------|--|
| Message  | Reminder of general procedures. You can carry out these procedures to eliminate the message.   |
| Warning  | Appears when there are malfunctions. A signal sounds in addition to the display. The signal becomes louder until you acknowledge by tapping the display. You can eliminate simple defects yourself. For more serious defects, you must contact customer service. |

### 6.5.1 Warnings



#### Close the door

This message appears if the door is open for too long.

You can set how long it takes for this message to appear.

- ▶ Stop alarm: Confirm the message.

-or-

- ▶ Close the door.



#### Power cut

This message appears if the freezer temperature increased due to a power cut. After the power is restored, the appliance continues to work at the set temperature.

- ▶ Stop alarm: Confirm the message.
- ▷ Temperature alert appears (see Temperature alarm).



#### Temperature alarm

This message appears if the temperature does not match the set temperature.

Variations in temperature could be because:

- Hot, fresh food was inserted.
- Too much warm room air flowed in when rearranging and removing food.

- The power was cut off for a while.
- The appliance is faulty.

When the fault is eliminated the appliance continues to work at the set temperature.

- ▶ Confirm the display.
- ▷ The highest temperature is shown.
- ▶ Confirm display again.
- ▷ The status display is displayed.
- ▷ The current temperature is shown.



## Error

This message appears if there is a fault with the appliance. An appliance component indicates a fault.

- ▶ Open the door.
- ▶ Note down the fault code.
- ▶ Confirm the message.
- ▷ The signal tone stops.
- ▷ The status display appears.
- ▶ Close the door.
- ▶ Contact customer service. (see 9.4 Customer Services)

## 6.5.2 Message



### Insert IceMaker drawer\*

This message appears if the IceMaker drawer is open.

- ▶ Push in the IceMaker drawer.
- ▷ The message disappears.
- ▷ The IceMaker produces ice cubes.

## 6.5.3 DemoMode

If "D" appears on the display, demo mode is on. This option is designed for retailers, as it turns off all the cooling functions.

### Stopping DemoMode

If you see the following running in the display:

- ▶ Confirm the display within the countdown.
- ▷ DemoMode is off.
- If the timer is not running:
- ▶ Unplug the appliance.
- ▶ Plug the appliance in again.
- ▷ DemoMode is off.

# 7 Features

## 7.1 Drawers

You can remove the drawers for cleaning.

You can remove the drawers to use VarioSpace.

The way to remove/insert the drawers varies depending on the pull-out system. Your appliance can contain various pull-out systems.

### Note

The energy consumption increases and the cooling power goes down if ventilation is not sufficient.

- ▶ Leave the bottom drawer in the appliance!
- ▶ Always leave the fan air vents clear on the back wall!

### 7.1.1 Top tilting drawer\*

When you pull out the top drawer, it tilts forward. This gives you a better view into the drawer. The function depends on the height of the appliance.

### Removing drawer

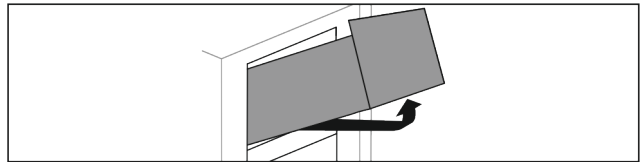

Fig. 13

- ▶ Pull out drawer as far as it will go.
- ▶ Lift drawer at the front.
- ▶ Lift drawer from below.
- ▶ Remove drawer to the front.

### Inserting drawer

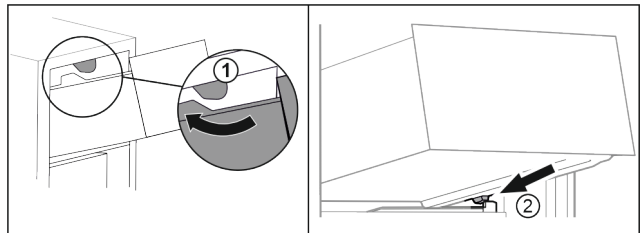

Fig. 14

- ▶ Guide drawer around the upper stoppers. Fig. 14 (1)
- ▶ Place drawer at an angle behind the lower stoppers onto moulded rib. Fig. 14 (2)
- ▶ Lower drawer.
- ▶ Slide to the back.

### 7.1.2 Drawer on moulded rib

The drawer runs directly on the moulded rib. There are no rails.

### Removing drawer

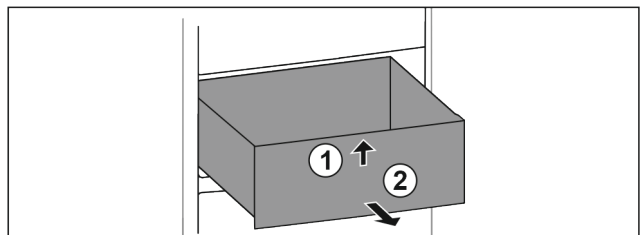

Fig. 15

- ▶ Pull out drawer as far as it will go.
- ▶ Lift up drawer at the front. Fig. 15 (1)
- ▶ Remove drawer to the front. Fig. 15 (2)

### Inserting drawer

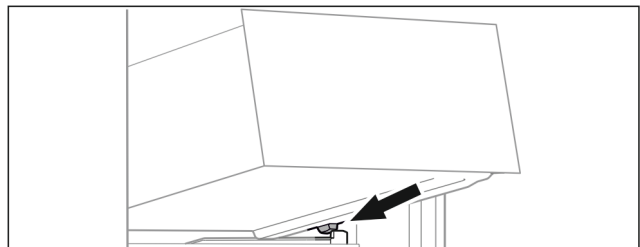

Fig. 16

- ▶ Place drawer at an angle behind the stoppers on the moulded rib. (see Fig. 1204)
- ▶ Lower drawer.
- ▶ Slide in drawer to the back.

# Features

## 7.2 Pull-out board with IceTower\*

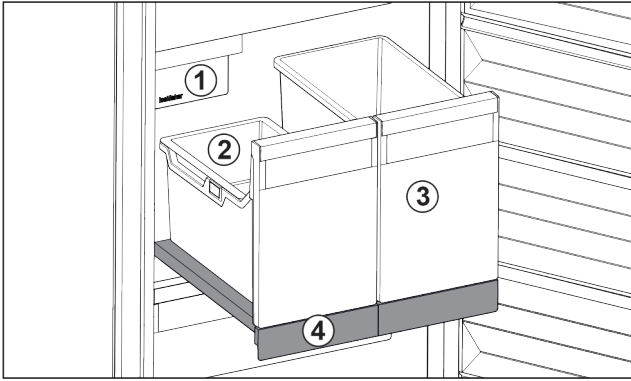

Fig. 17 Pull-out board with IceTower

- (1) IceMaker
- (2) Hang-on tray for ice cubes
- (3) Container for pizza or alcoholic beverages, for example
- (4) Pull-out board

There are two high (IceTower) containers on the pull-out board. Ice cubes from the IceMaker are collected and stored in the Fig. 17 (2) container. The container Fig. 17 (3) is suitable for storing tall foodstuffs or beverages such as pizzas or alcoholic drinks.

The pull-out board with IceTower is mounted on a glass shelf with pull-out rails. You can dismantle the pull-out board for cleaning.

### 7.2.1 Dismantling the pull-out board with IceTower

#### Removing the container

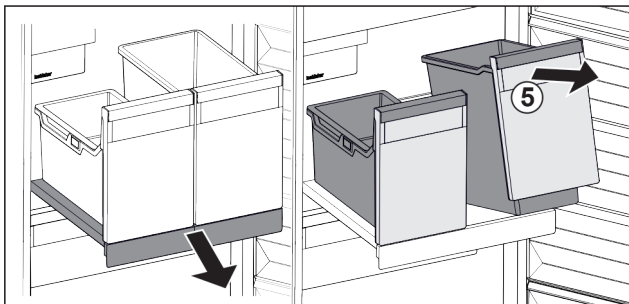

Fig. 18

- ▶ Pull out the pull-out board.
- ▶ Lift the container Fig. 18 (5) at the front.
- ▶ Remove the container.

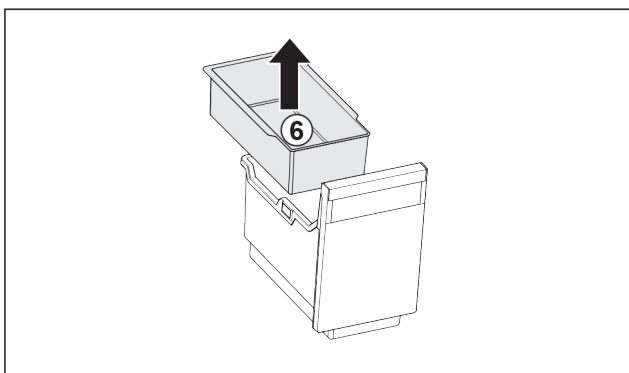

Fig. 19

- ▶ Remove the hang-on tray Fig. 19 (6).
- ▶ If there are ice cubes in the hang-on tray: Empty the hang-on tray.
- ▷ The container and hang-on tray have been removed and you can clean them. (see 8.5.4 Clean the components)

#### Removing the pull-out board

Ensure that the following conditions are met:

- ❑ Containers have been removed. (see 7.2.1.1 Removing the container)

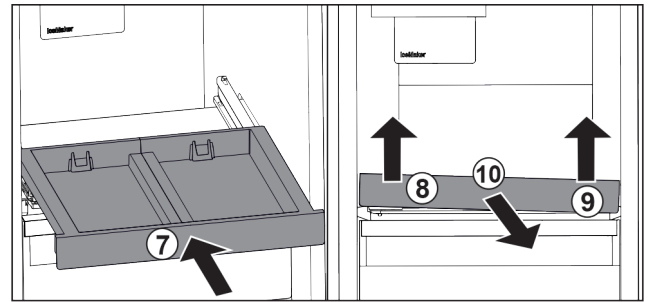

Fig. 20

- ▶ Slide in the pull-out board. Fig. 20 (7)
- ▶ Lift the pull-out board on the front left. Fig. 20 (8)
- ▶ Lift the pull-out board on the front right. Fig. 20 (9)
- ▷ Pull-out board is detached from the attachment at the front.
- ▶ Take out the pull-out board to the front. Fig. 20 (10)
- ▷ The pull-out board has been removed and you can clean it. (see 8.5.4 Clean the components)

#### Removing the glass shelf from under the pull-out board

(see 7.3 Glass shelves)

### 7.2.2 Inserting the pull-out board with IceTower

#### Inserting the glass shelf from under the pull-out board

(see 7.3 Glass shelves)

#### Inserting the pull-out board

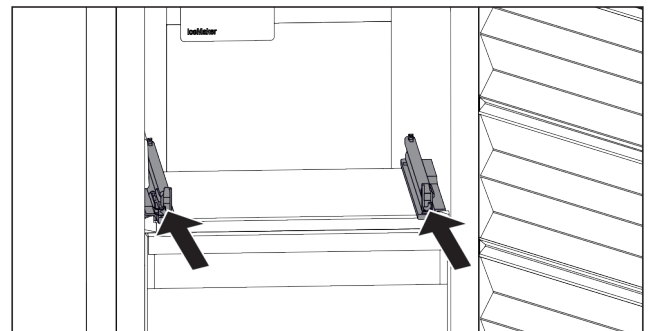

Fig. 21

- ▶ Slide the rails in.

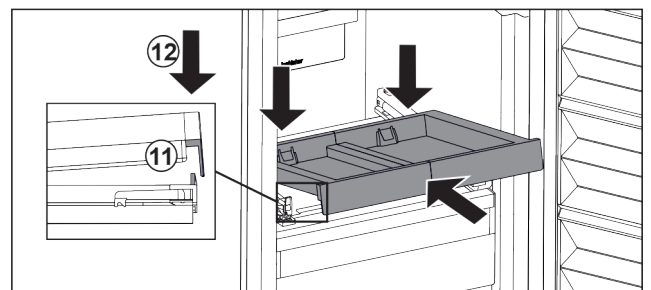

Fig. 22

- ▶ Place the pull-out board in at an angle behind the front lug.
- ▶ Slide in at an angle. Make sure that the stop is behind the lug on both sides. Fig. 22 (11)
- ▶ Lower the pull-out board at the front. Fig. 22 (12)

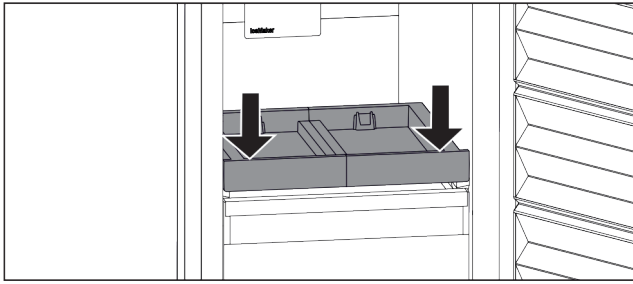

Fig. 23

- ▶ Push the pull-out board down at the front.
- ▷ Pull-out board clicks into place.

### Inserting the container

Ensure that the following conditions are met:

- The pull-out board is inserted. (see 7.2.2.2 Inserting the pull-out board)

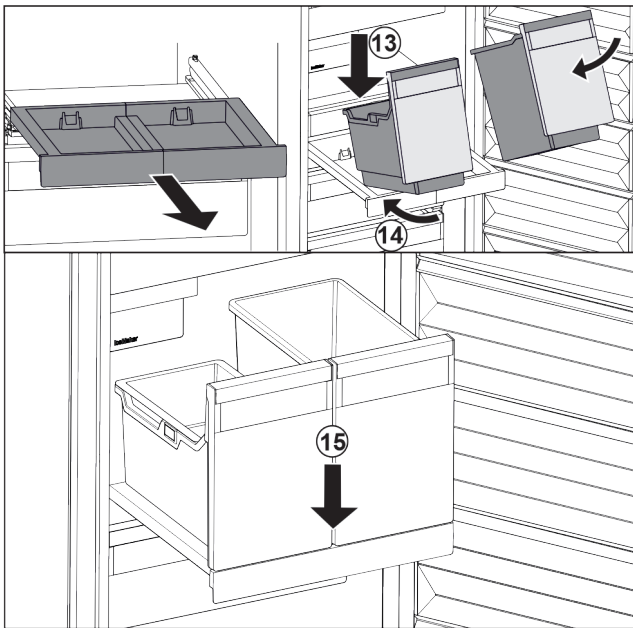

Fig. 24

- ▶ Pull out the pull-out board.
- ▶ Hold the pull-out board with one hand.

### Note

The containers are shaped in a way that they cannot be interchanged.

- ▶ Place the container at an angle on the pull-out board. Fig. 24 (13)
- ▶ Slide the container to the back at an angle. Fig. 24 (14)
- ▶ Place container in the front. Fig. 24 (15)

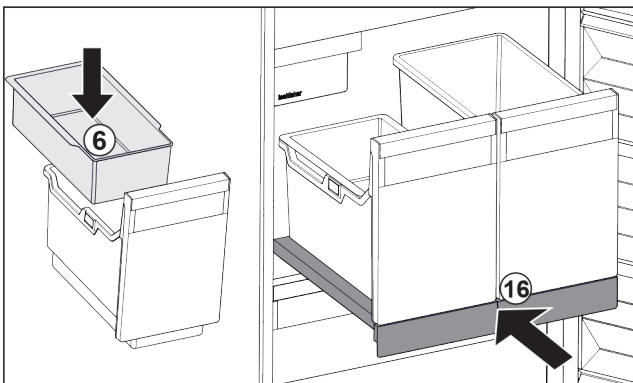

Fig. 25

- ▶ Insert hang-on tray Fig. 25 (6) for ice cubes.

- ▶ Slide in the pull-out board with (IceTower) container. Fig. 25 (16)
- ▷ Pull-out shelf with IceTower is fully inserted.

## 7.3 Glass shelves

### NOTICE

Impermissible removal of the glass panel above the IceTower!\*

Damage to the IceMaker. The IceMaker is attached to the glass panel above the IceTower.

- ▶ Do not remove the glass panel above the IceTower.

You can remove the glass shelves under the drawers for cleaning.

You can remove the glass shelves under the drawers to use VarioSpace.

### 7.3.1 Removing / inserting the glass shelf

Make sure that the following requirements are fulfilled:

- Glass shelf under the drawer: The drawer has been removed. (see 7.1 Drawers)
- Pull-out board under IceTower: IceTower has been removed. (see 7.2 Pull-out board with IceTower\*) \*

#### Removing glass shelf

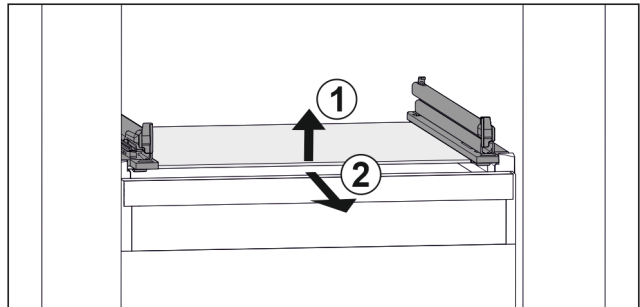

Fig. 26 Example illustration of glass shelf

- ▶ Lift glass shelf at the front. Fig. 26 (1)
- ▶ Take out glass shelf to the front. Fig. 26 (2)

#### Inserting glass shelf

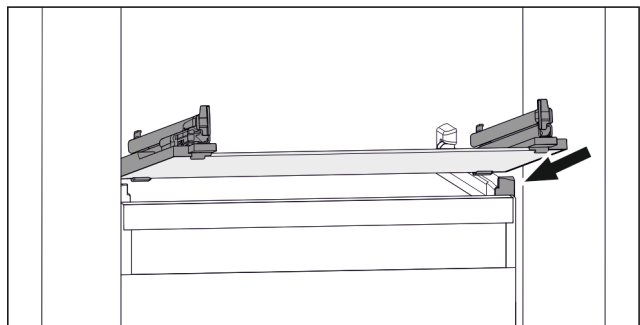

Fig. 27 Example illustration of glass shelf

- ▶ Position glass shelf at an angle behind the stoppers. (see Fig. 1215)
- ▶ Lower glass shelf.
- ▶ Slide in glass shelf to the back.

## 7.4 EasyTwist-Ice\*

The EasyTwist-Ice produces ice cubes when the water tank is inserted.

The EasyTwist-Ice is solely intended for the production of ice cubes for in standard household amounts.

### Note

Do not change the position of the EasyTwist-Ice.

# Features

Ensure that the following conditions are met:

- The EasyTwist-Ice has been cleaned (see 8.5.5 Cleaning the EasyTwist-Ice\*)
- The water tank has been cleaned.
- The EasyTwist-Ice drawer is fully inserted.

## 7.4.1 Filling the water tank



### WARNING

Impure water!  
Poisoning.

- ▶ Only fill with potable water.

### NOTICE

Sugar-content liquids!  
Damage to EasyTwist-Ice.

- ▶ Only fill with cold drinking water.

### Note

Using filtered, decarbonised water ensures the best-tasting drinking water for your ice cubes.

This water quality can be achieved using a table water filter of the kind available in trade retail outlets.

- ▶ Always fill the water tank only with filtered, decarbonised drinking water.

The EasyTwist-Ice is supplied with water from the water tank.

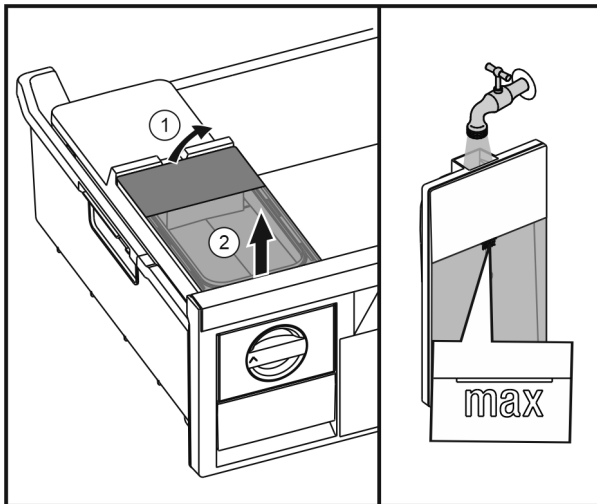

Fig. 28

- ▶ Lift up the water tank at the rear Fig. 28 (1) and remove to the top Fig. 28 (2).
- ▶ Fill with drinking water up to the marking.
- ▶ Insert the water tank by reversing the steps described above.

## 7.4.2 Producing ice cubes

The production volume depends on the freezer temperature. The colder the temperature, the more ice cubes that can be produced in a certain period.

Maximum capacity of the ice cube drawer – 40 cubes (2x ice cube production).

Time required for ice cube production – at least 5 hours.

### Releasing the ice cubes

- ▶ Turn the knob to the right up to its stop limit.
- ▶ If necessary, repeat this step several times and turn the knob a little more.

## 7.5 IceMaker\*

The IceMaker will produce ice cubes for household use only.

Ensure that the following conditions are met:

- IceMaker is cleaned (see 8 Maintenance) .
- IceMaker drawer is fully inserted.

### 7.5.1 Producing ice cubes

The volume depends on the freezing temperature. The colder the temperature, the more ice cubes the system can produce in a certain time period.

After the IceMaker is turned on for the first time, it can take up to 24 hours for the first ice cubes to be made.

- ▶ Activate the IceMaker function (see 6.2 Control concept) .
- ▶ To make a high number of ice cubes: Activate the MaxIce function (see 6.2 Control concept) .
- ▶ Distribute the ice cubes evenly in the drawer to increase the capacity.
- ▶ Closing the drawer: IceMaker starts making ice cubes again automatically.

### Note

When a certain level is reached in the IceMaker drawer, it stops producing ice cubes. The IceMaker does not fill the drawer all the way to the top.

## 7.6 VarioSpace

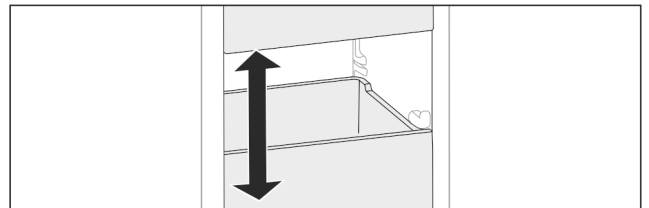

Fig. 29

You can remove drawers and glass panels from your appliance. This provides more room for large food items such as poultry, joints of meat, large game, and tall baked products. You can then freeze these items whole for later preparation.

- ▶ Note the weight limits on the drawers and glass panels (see 9.1 Technical specifications) .

## 7.7 Accessories

### 7.7.1 Freezer pack\*

Freezer packs prevent the temperature rising too quickly should there be a power cut.

The freezer packs are in the drawer.

You can store the freezer packs in the freezer tray.\*

### Using the freezer pack

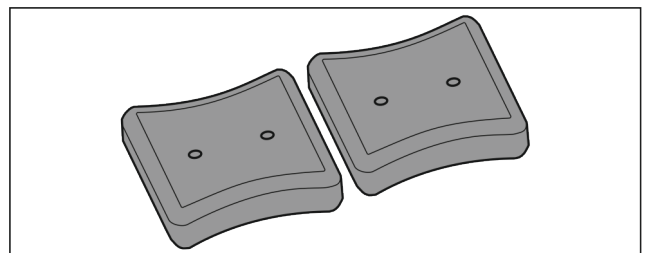

Fig. 30

When the freezer packs are fully frozen:

- ▶ Place on the frozen goods in the top, front part of the freezer.

## 8 Maintenance

### 8.1 Disassembling / assembling pull-out systems

You can disassemble some of the pull-out systems for cleaning. Your appliance can contain various pull-out systems.

The following pull-out systems can be disassembled or cannot be disassembled:

| Pull-out system        | can be disassembled / cannot be disassembled        |
|------------------------|---|
| Top drawer*<br>tilting | cannot be disassembled*                             |
| Drawer on moulded rib  | can be disassembled (see 8.2 Drawer on moulded rib) |
| IceTower*              | can be disassembled (see 8.3 IceTower*) *           |

### 8.2 Drawer on moulded rib

#### 8.2.1 Disassembling pull-out system

Make sure the following prerequisites are met:

- Drawer has been removed. (see 7.1.2 Drawer on moulded rib)

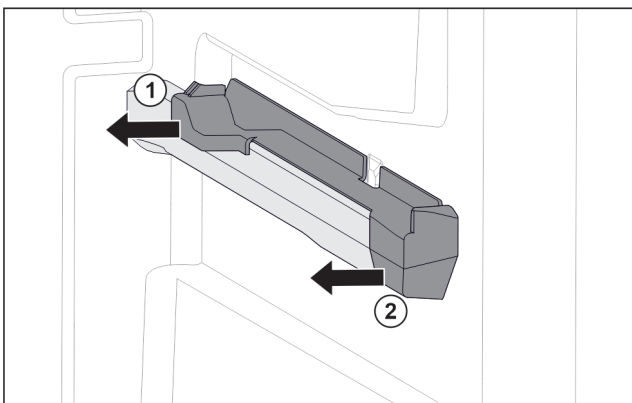

Fig. 31 Attachment on the right moulded rib

- ▶ Grab attachment at the back from below.
- ▶ Pull off attachment at the back sideways. Fig. 31 (1)
- ▶ Pull off attachment at the front sideways. Fig. 31 (2)

#### 8.2.2 Installing pull-out system

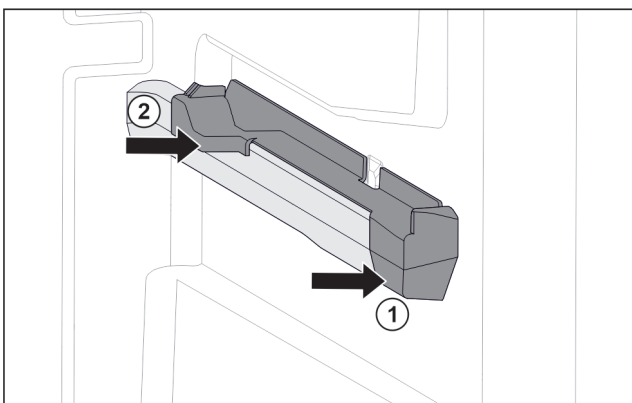

Fig. 32 Attachment on the right moulded rib

- ▶ Position attachment on moulded rib at the front. Fig. 32 (1)

- ▶ Press on attachment at the back. Fig. 32 (2)

### 8.3 IceTower\*

#### 8.3.1 Disassembling pull-out system

Make sure the following prerequisites are met:

- IceTower has been removed. (see 7.2 Pull-out board with IceTower\*)
- Glass shelf has been removed. (see 7.3 Glass shelves)
- ▶ Place pull-out board on a table.
- ▶ You are able to remove the rails more easily from the glass shelf.

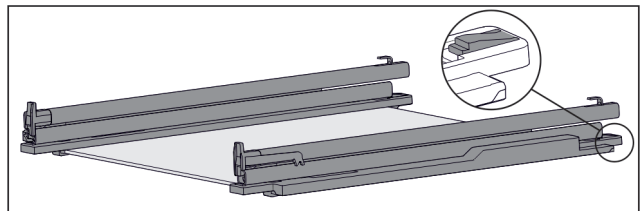

Fig. 33 Glass shelf with rails and retaining parts

- ▶ Press down retaining part at the rear (see Fig. 1221) and at the same time push the rail back.

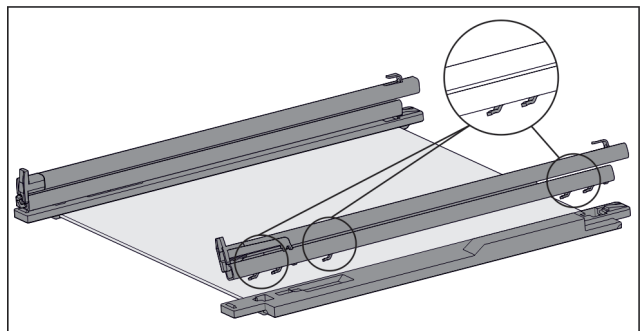

Fig. 34 Glass shelf with rails and retaining parts

- ▶ The rail hooks are released from the retaining part.
- ▶ Remove rail from retaining part.

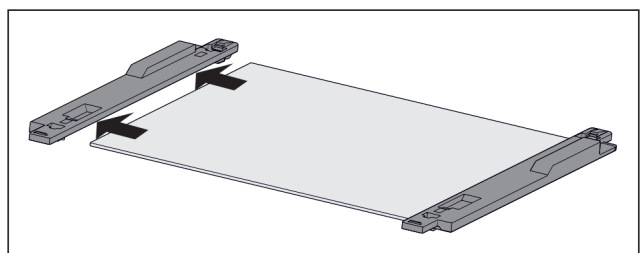

Fig. 35 Glass shelf with retaining part

- ▶ Remove retaining part from glass shelf sideways.

#### 8.3.2 Installing pull-out system

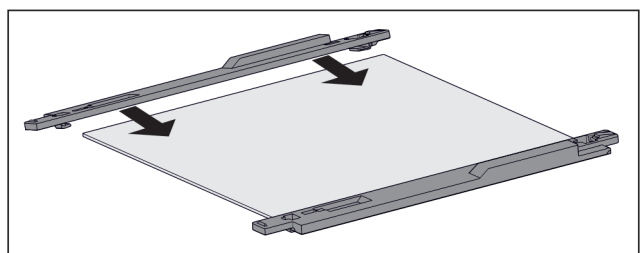

Fig. 36 Glass shelf with retaining part

- ▶ Fit retaining part on glass shelf.
- ▶ Push retaining part onto glass shelf as far as it will go.

# Maintenance

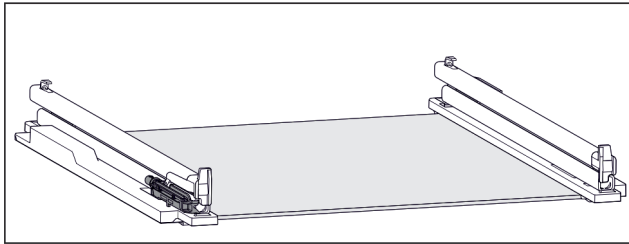

Fig. 37 Damping mechanism

The damping mechanism is attached to the left rail. (see Fig. 1225) There is no damping mechanism attached to the right rail.

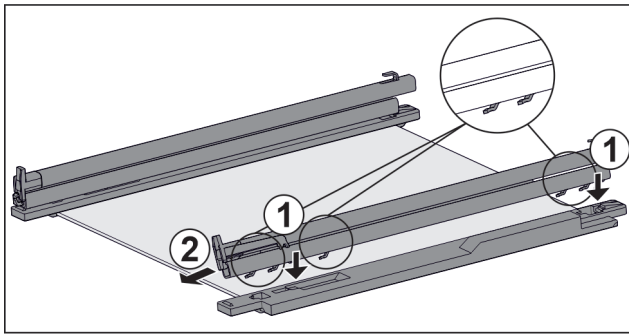

Fig. 38 Glass shelf with rails and retaining parts

Install rail **with** damping mechanism:

- ▶ Place rail hooks onto the openings of the **left** retaining part. Fig. 38 (1)
- ▶ Push rail forwards. Fig. 38 (2)
- ▷ Rail latches in audibly.

Install rail **without** damping mechanism:

- ▶ Place rail hooks onto the openings of the **right** retaining part. Fig. 38 (1)
- ▶ Push rail forwards. Fig. 38 (2)
- ▷ Rail latches in audibly.

## 8.4 Defrosting the appliance

### 8.4.1 Defrosting with NoFrost

Defrosting is performed automatically with the NoFrost system. The moisture is deposited on the evaporator, is periodically defrosted and evaporates.

The appliance does not need to be defrosted.

#### Note

Water droplets may collect on the bottom of the appliance. When you take the appliance out of operation:

- ▶ Place a towel in front of the appliance to catch any drops of water that may run out. (see 10 Shutting down)

## 8.5 Cleaning the appliance

### 8.5.1 Ready



#### WARNING

Danger of electric shock!

- ▶ Remove the refrigerator connector or interrupt the power supply.



#### WARNING

Risk of fire

- ▶ Do not damage the refrigeration circuit.

- ▶ Empty the appliance.

- ▶ Remove mains connector.

### 8.5.2 Clean the housing

#### NOTICE

Improper cleaning!

Damage to the appliance.

- ▶ Only use soft cleaning cloths and ph-neutral all-purpose cleaners.
- ▶ Do not use abrasive sponges or steel wool which may cause scratches.
- ▶ Do not use any sharp or abrasive cleaning agents, nor any that contain sand, chloride or acid.



#### WARNING

Risk of injury and damage as a result of hot steam!

Hot steam can lead to burns and can damage the surfaces.

- ▶ Do not use any steam cleaners!

- ▶ Wipe the housing down with soft, clean cloth. If very dirty, use lukewarm water with a neutral cleaner. Glass surfaces can also be cleaned with glass cleaner.

### 8.5.3 Cleaning the interior

#### NOTICE

Improper cleaning!

Damage to the appliance.

- ▶ Only use soft cleaning cloths and ph-neutral all-purpose cleaners.
- ▶ Do not use abrasive sponges or steel wool which may cause scratches.
- ▶ Do not use any sharp or abrasive cleaning agents, nor any that contain sand, chloride or acid.

- ▶ Plastic surfaces: clean by hand with a soft clean cloth, lukewarm water and a little detergent.

- ▶ Metal surfaces: clean by hand with a soft clean cloth, lukewarm water and a little detergent.

### 8.5.4 Clean the components

#### NOTICE

Improper cleaning!

Damage to the appliance.

- ▶ Only use soft cleaning cloths and ph-neutral all-purpose cleaners.
- ▶ Do not use abrasive sponges or steel wool which may cause scratches.
- ▶ Do not use any sharp or abrasive cleaning agents, nor any that contain sand, chloride or acid.

Clean with a soft, clean cloth, lukewarm water and some detergent:

- IceTower pull-out board\*

- Drawer

Please note: Do not remove the magnet on the drawer.

The magnet ensures the functionality of the IceMaker.\*

- Freezer tray\*

Wash in the dishwasher up to 60 °C:

- Ice cube tray\*

- Ice cube scoop\*

- ▶ To disassemble components: see the relevant section.

- ▶ Clean the components.

### 8.5.5 Cleaning the EasyTwist-Ice\*

Cleaning is required in the following cases:

- Initial operation

- Disuse for more than 48 hours
- The appliance requires cleaning.

**In the case of initial operation, longer periods of disuse or the appliance requiring cleaning**

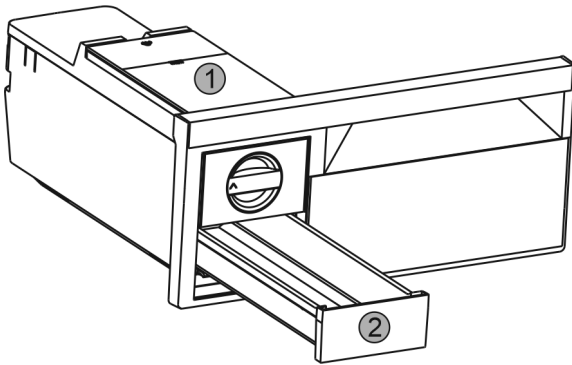

Fig. 39

- ▶ Take out the water tank Fig. 39 (1) and ice cube drawer Fig. 39 (2).
- ▶ Take out the freezer drawer with EasyTwist-Ice.

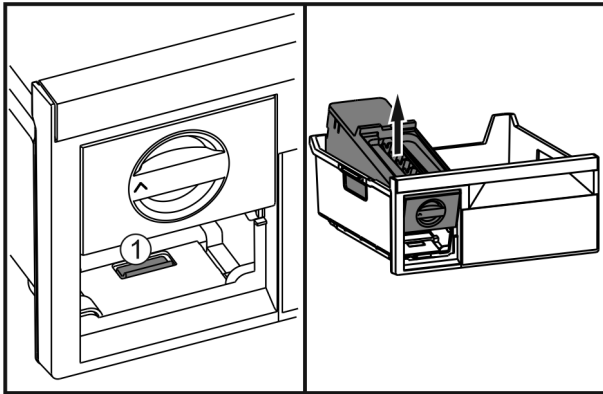

Fig. 40

- ▶ Press the lug Fig. 40 (1), lift up the EasyTwist-Ice at the rear and take it out of the freezer drawer.

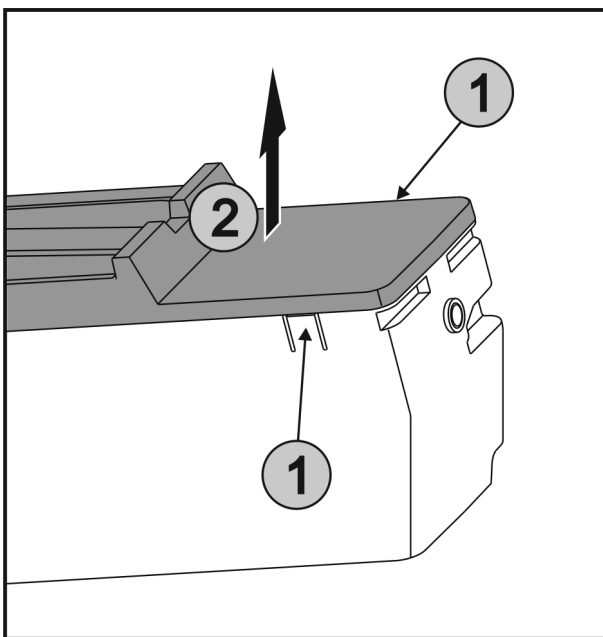

Fig. 41

- ▶ Press the lugs Fig. 41 (1) on both sides of the EasyTwist-Ice simultaneously and take off the lid Fig. 41 (2) to the top.

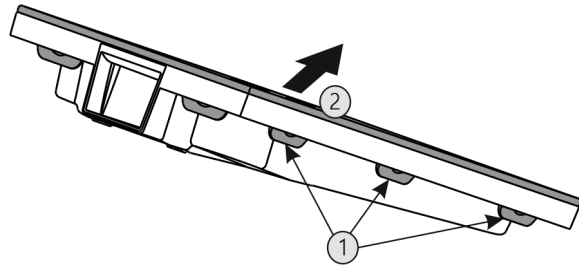

Fig. 42

- ▶ Press all lugs Fig. 42 (1) in succession and remove the lid Fig. 42 (2).
- ▶ Clean the ice cube drawer, water tank and EasyTwist-Ice with warm water and a little detergent.
- ▶ Assemble the EasyTwist-Ice.

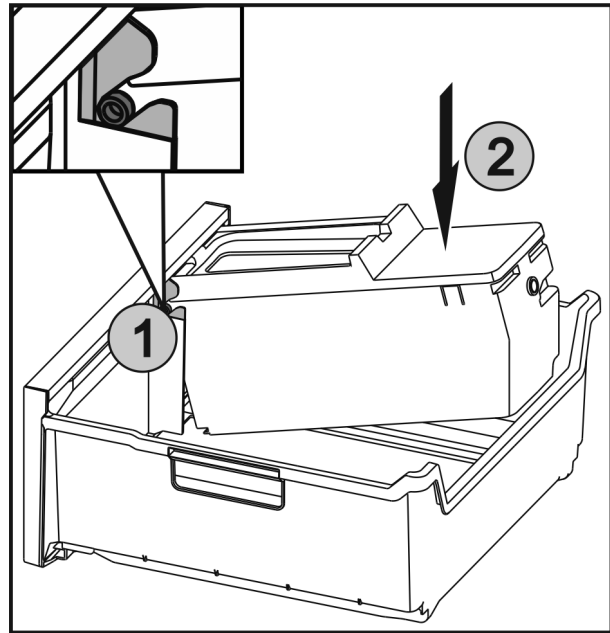

Fig. 43

- ▶ Push the axles Fig. 43 (1) on the EasyTwist-Ice into the guides and push the rear side Fig. 43 (2) until the lugs engage.
- ▶ Push in the EasyTwist-Ice drawer.



## WARNING

Impure water!  
Poisoning.

- ▶ Only fill with potable water.

- ▶ Fill the water tank with water and insert it. (see 7.4.1 Filling the water tank)

With non-filtered water:

- ▶ Dispose of any ice cubes that were made within 24 hours of the first ice cubes that were produced.

With filtered water:

- ▶ Dispose of any ice cubes that were made within 48 hours of the first ice cubes that were produced.

## 8.5.6 Cleaning the IceMaker\*

There are various options for cleaning the IceMaker.

Cleaning is required in the following cases:

- Initial operation
- If out of use for more than 5 days.\*

Ensure that the following conditions are met:

- IceMaker drawer is emptied.

# Customer help

- IceMaker drawer is in place.
- The IceMaker is activated. (see 6.2 Control concept)

## First use or after a long period of non-use

Clean the IceMaker with the TubeClean function.

- ▶ Place a 1.5 l empty container (max. height 10 cm) into the drawer under the IceMaker.
- ▶ Activate the TubeClean function. (see 6.2 Control concept)
- ▷ The rinse process is prepared (max. 60 min.): Symbol flashes.
- ▷ Water pipes are rinsed: Symbol flashes.
- ▷ Rinsing process is complete: Function turns off automatically.
- ▶ Remove the IceMaker drawer and remove the container.
- ▶ Clean the IceMaker drawer with warm water and a little detergent.
- ▶ Push the IceMaker drawer in.
- ▷ The system starts making ice cubes automatically.
- ▶ Dispose of any ice cubes that were made 24 hours after the first ice cubes.

## If cleaning is required

Clean the IceMaker by hand.

- ▶ Remove the IceMaker drawer and clean with warm water and a little detergent.
- ▶ Push the IceMaker drawer in.
- ▷ The system starts making ice cubes automatically.

## 8.5.7 After cleaning

- ▶ Wipe the appliance and the components dry.
- ▶ Connect and switch on the appliance.
- ▶ Activate SuperFrost (see 6.3 Functions) .  
The temperature is cold enough:
- ▶ Place the food inside.
- ▶ Repeat cleaning regularly.

# 9 Customer help

## 9.1 Technical specifications

| Temperature range |                  |
|-------------------|------------------|
| Freeze            | -28 °C to -15 °C |

| Maximum freezer quantity / 24 hrs |  |
|-----------------------------------|--|
| Freezer compartment               | See the type plate under "Freezer goods ... /24 hours" |

| Maximum component capacity |  |  |  |
|----------------------------|--|--|--|
| Features                   | Appliance width 550 mm (see installation instructions, appliance dimensions) | Appliance width 600 mm (see installation instructions, appliance dimensions) | Appliance width 700 mm (see installation instructions, appliance dimensions) |
| Drawer on moulded rib      | 14 kg  | 19 kg  | 19 kg  |
| Bottom drawer              | --   | 11 kg  | 19 kg  |
| Top tilting drawer*        | --*  | 19 kg*   | 19 kg*   |

| Ice cube production with IceMaker*     |  |
|--|--|
| Ice cube production / 24 h             | At a temperature of -18 °C: 0.8 kg of ice cubes  |
| Maximum ice cube production / 24 hours | With the MaxIce function on: 1.2 kg of ice cubes |

| Ice cube production with EasyTwist-Ice* |               |
|---|---------------|
| Time required at -18 °C                 | approx. 5.5 h |
| Time required with SuperFrost activated | approx. 3 h   |

## 9.2 Operating noises

The appliance makes different noises when it is on.

- At **higher temperatures** the appliance uses less energy but works for longer. It is **quieter**.
- At **lower temperatures** the food is cooled faster. It is **louder**.

Examples:

- Functions on (see 6.3 Functions)
- Fan running
- Food recently added
- High ambient temperature
- Door open for a while

| Noise                  | Possible cause  | Type of noise          |
|------------------------|---|------------------------|
| Bubbling and splashing | Coolant flowing into the cooling circuit.                           | Normal operating noise |
| Hissing                | Coolant sprays into the cooling circuit.                            | Normal operating noise |
| Humming                | The appliance is cooling. The volume depends on the cooling output. | Normal operating noise |
| Humming and rustling   | The fan is running.   | Normal operating noise |
| Clicking               | Components are switched on and off.                                 | Normal switching noise |
| Rattling or humming    | Valves or flaps are working.  | Normal switching noise |

| Noise     | Possible cause                         | Type of noise   | Lifting  |
|-----------|--|-----------------|--|
| Vibration | Improper setup                         | Defective noise | Level the appliance using the adjustable feet.           |
| Rattling  | Components, items inside the appliance | Defective noise | Secure components. Leave enough space between the items. |

## 9.3 Technical fault

Your appliance is designed and built to ensure it works reliably and has a long service life. In the unlikely event that a fault occurs during operation, please check whether it is due to an operating error. If so, you will be charged for the

callout and repair costs even if it falls within the warranty period.

You can fix the following faults yourself.

### 9.3.1 Appliance function

| Defect  | Cause   | Remedy   |
|---|---|--|
| <b>The appliance is not working.</b>  | → The appliance is not switched on.   | ▶ Switch the appliance on.   |
|   | → The power plug is not properly plugged into the socket.                               | ▶ Check the power plug.  |
|   | → There is something wrong with the power outlet fuse.                                  | ▶ Check the fuse.  |
|   | → Power cut   | ▶ Keep the appliance closed.<br>▶ Protecting food: Lay freezer packs on top of the food or use another freezer if the power is off for a prolonged period.<br>▶ Do not re-freeze defrosted food, |
|   | → The appliance plug does not fit the appliance properly.                               | ▶ Check the appliance plug.  |
| <b>Temperature is not cold enough.</b>  | → The appliance door is not closed properly.  | ▶ Close the appliance door.  |
|   | → Not enough ventilation.   | ▶ Keep ventilation grille clear, and clean it.   |
|   | → The ambient temperature is too high.  | ▶ Solution: (see 1.3 Appliance range of use) .   |
|   | → The appliance was opened too many times or for too long.                              | ▶ Wait to see if the required temperature corrects itself. If not, contact Customer Service (see 9.4 Customer Services) .  |
|   | → Too much fresh food was placed inside without SuperFrost.                             | ▶ Solution: (see SuperFrost)   |
|   | → The temperature is set incorrectly.   | ▶ Turn down the temperature and check after 24 hours.  |
|   | → The appliance is too close to a heat source (oven, radiator, etc).                    | ▶ Move the appliance or the heat source.   |
| <b>The door seal is defective or needs to be replaced for another reason.</b> | → The door seal can be replaced. It can be replaced without the need for special tools. | ▶ Contact Customer Services (see 9.4 Customer Services) .  |
| <b>The appliance builds up too much ice or condensation.</b>                  | → The door seal may have slipped out of its groove.                                     | ▶ Check that the door seal is well fitted in the groove.   |
| <b>The appliance is hot to touch on the outside*.</b>                         | → The heat of the refrigeration circuit is used to avoid condensation.                  | ▶ This is normal.  |

### 9.3.2 Features

| Defect   | Cause   | Remedy  |
|--|---|---|
| <b>You cannot activate the IceMaker.*</b>        | → The appliance and therefore the IceMaker are not connected. | ▶ Connect the appliance (see the Installation Guide). |
| <b>The IceMaker is not producing ice cubes.*</b> | → The IceMaker is not on.                                     | ▶ Activate the IceMaker.                              |
|  | → The drawer of the IceMakers is not connected properly.      | ▶ Push the drawer in correctly.                       |
|  | → The water connection is not open.                           | ▶ Open the water connection.*                         |

# Shutting down

## 9.4 Customer Services

First check if you can fix the error yourself (see 9 Customer help) . If you can't, contact Customer Services.

Please refer to the enclosed "Liebherr-Service" brochure for the address.



### WARNING

Unprofessional repair!  
Injuries.

- ▶ Have any repairs and action - not expressly specified - on the appliance and mains cable carried out by service personnel only. (see 8 Maintenance)
- ▶ A damaged mains cable may only be replaced by the manufacturer, the manufacturer's Customer Service or a similarly qualified person.
- ▶ In the case of appliances with an IEC connector, the change may be made by the customer.

### 9.4.1 Contact Customer Services

Make sure you have the following appliance data at the ready:

- Appliance name (model and index)
- Service no. (Service)
- Serial no. (S no.)

- ▶ Look up the appliance information on the display (see Info) .

-or-

- ▶ Referring to appliance info on the nameplate (see 9.5 Model plate) .

- ▶ Note down the appliance information.
- ▶ Notify Customer Services of the following: Give us the appliance data.
- ▷ This will help us to provide you with a faster, more accurate service.
- ▶ Follow any further instructions given by Customer Services.

## 9.5 Model plate

The model plate is behind the drawers on the inside of the appliance.

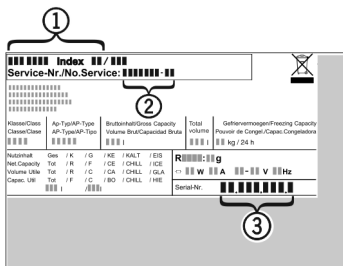

Fig. 44

- (1) Appliance description      (3) Serial no.
- (2) Service no.
- ▶ Note the data on the model plate.

## 10 Shutting down

- ▶ Empty the appliance.
- ▶ Turn off the IceMaker.\*
- ▶ Turn off the appliance (see 6.4 Settings) .
- ▶ Remove mains connector.
- ▶ Remove appliance connector if required: Remove and move from left to right at the same time.
- ▶ Place a towel in front of the appliance to catch any drops of water that may run out.
- ▶ Clean the appliance (see 8.5 Cleaning the appliance) .

- ▶ Leave the door open to avoid bad smells building up.

## 11 Disposal

### 11.1 Preparing appliance for disposal



Li-Ion

Liebherr uses batteries in some of its appliances. In the EU, for environmental reasons, legislation obliges the end user to remove these batteries before disposing of old appliances. If your appliance contains batteries, a corresponding notice is attached.

Lamps

If you can remove the lamps yourself without destroying them, also remove these before disposal.

- ▶ Take the appliance out of operation.
- ▶ Appliances with batteries: remove the batteries. For description, see **Maintenance** chapter.
- ▶ If possible: remove lamps without destroying them.

### 11.2 Disposing of the appliance in an environmentally friendly manner



The appliance still contains valuable materials and must be disposed of separately from unsorted municipal waste.



Li-Ion



Li-Ion

Dispose of batteries separately from the old appliance. To do this, you can return the batteries free of charge to retailers as well as recycling centres and collection centres for recyclable materials.

Lamps

Dispose of removed lamps via the respective collection systems.

For Germany:

You can dispose of the appliance free of charge via the class 1 collection containers at the local recycling and recyclable material collection centres. When purchasing a new fridge/freezer, if the sales area > 400 m<sup>2</sup>, retailers will also take back the old appliance free of charge.



### WARNING

Leaking coolant and oil!  
Fire. The coolant contained in the appliance is eco-friendly, but also flammable. The oil contained in the appliance is flammable. Escaping coolant and oil can ignite if the concentration is high enough and in contact with an external heat source.

- ▶ Do not damage the pipelines of the coolant circuit and the compressor.

- ▶ Transport the appliance without damaging it.
- ▶ Dispose of batteries, lamps and the appliance according to the above specifications.





[home.liebherr.com/fridge-manuals](https://home.liebherr.com/fridge-manuals)

**EN** freezer

Issue date: 20221024

**Part number index: 7088347-00**

Liebherr-Hausgeräte Ochsenhausen GmbH  
Memminger Straße 77-79  
88416 Ochsenhausen  
Deutschland

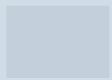

User Guide

Quality, Design and Innovation

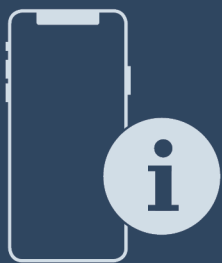



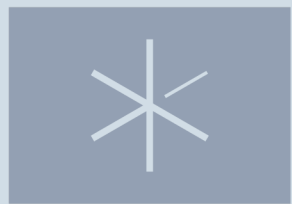
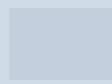













[home.liebherr.com/fridge-manuals](http://home.liebherr.com/fridge-manuals)





# LIEBHERR



# Contents

|   |   |          |
|---|---|----------|
| <b>1</b>  | <b>Appliance at a glance.....</b>           | <b>3</b> |
| 1.1   | Scope of delivery.....                      | 3        |
| 1.2   | Overview of the appliance and features..... | 3        |
| 1.3   | Appliance range of use.....                 | 3        |
| 1.4   | Conformity.....                             | 4        |
| 1.5   | EPREL database.....                         | 4        |
| <b>2</b>  | <b>General safety instructions.....</b>     | <b>4</b> |
| <b>3</b>  | <b>Putting into operation.....</b>          | <b>5</b> |
| 3.1   | Switching on appliance.....                 | 5        |
| 3.2   | Inserting the components.....               | 6        |
| <b>4</b>  | <b>Foods management.....</b>                | <b>6</b> |
| 4.1   | Storing food.....                           | 6        |
| 4.2   | Storage times.....                          | 6        |
| <b>5</b>  | <b>Saving energy.....</b>                   | <b>6</b> |
| <b>6</b>  | <b>Controls.....</b>                        | <b>6</b> |
| 6.1   | Controls and displays.....                  | 6        |
| 6.1.1   | Status display.....                         | 7        |
| 6.1.2   | Navigation.....                             | 7        |
| 6.1.3   | Operating structure.....                    | 7        |
| 6.1.4   | Display symbols.....                        | 7        |
| 6.2   | Control concept.....                        | 7        |
| 6.2.1   | Activating/deactivating the function.....   | 7        |
| 6.2.2   | Selecting function value.....               | 8        |
| 6.2.3   | Activating/deactivating settings.....       | 8        |
| 6.2.4   | Selecting the setting value.....            | 8        |
| 6.2.5   | Go to the Customer menu.....                | 8        |
| 6.3   | Functions.....                              | 9        |
|   | Turn off appliance.....                     | 9        |
|  | Connecting to the WLAN.....                 | 9        |
|  | Temperature.....                            | 9        |
|  | Temperature unit.....                       | 10       |
|  | SuperCool.....                              | 10       |
|  | PowerCool.....                              | 10       |
|  | PartyMode*.....                             | 10       |
|  | HolidayMode.....                            | 10       |
|  | SabbathMode.....                            | 10       |
|  | E-Saver.....                                | 11       |
|  | CleaningMode.....                           | 11       |
|  | Display brightness.....                     | 11       |
|  | Door alarm.....                             | 11       |
|  | Entry lock.....                             | 11       |
|  | Info.....                                   | 11       |
|  | Reminder.....                               | 12       |

|   |   |           |
|---|---|-----------|
|  | Reset.....  | 12        |
| 6.4   | Fault messages.....   | 12        |
| 6.4.1   | Warnings.....   | 12        |
| 6.4.2   | DemoMode.....   | 12        |
| <b>7</b>  | <b>Features.....</b>  | <b>12</b> |
| 7.1   | Door rack.....  | 12        |
| 7.2   | Shelves.....  | 12        |
| 7.3   | Dividing shelf*.....  | 13        |
| 7.4   | VarioSafe*.....   | 13        |
| 7.5   | Drawers.....  | 14        |
| 7.6   | EasyFresh-Safe cover.....   | 14        |
| 7.7   | Adjusting the moisture levels.....                                    | 15        |
| 7.8   | Pull-out board with bottle basket*.....                               | 15        |
| 7.9   | Glass shelves.....  | 16        |
| 7.10  | Accessories.....  | 16        |
| <b>8</b>  | <b>Maintenance.....</b>   | <b>16</b> |
| 8.1   | FreshAir carbon filter.....   | 16        |
| 8.2   | Disassembling / assembling pull-out systems.....                      | 17        |
| 8.3   | Defrosting the appliance.....   | 17        |
| 8.4   | Cleaning the appliance.....   | 17        |
| <b>9</b>  | <b>Customer help.....</b>   | <b>18</b> |
| 9.1   | Technical specifications.....   | 18        |
| 9.2   | Operating noises.....   | 18        |
| 9.3   | Technical fault.....  | 18        |
| 9.4   | Customer Services.....  | 19        |
| 9.5   | Model plate.....  | 20        |
| <b>10</b>   | <b>Shutting down.....</b>   | <b>20</b> |
| <b>11</b>   | <b>Disposal.....</b>  | <b>20</b> |
| 11.1  | Preparing appliance for disposal.....                                 | 20        |
| 11.2  | Disposing of the appliance in an environmentally friendly manner..... | 20        |

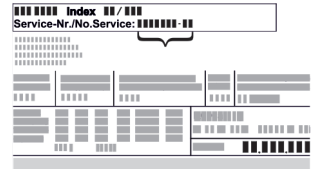
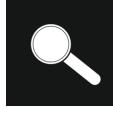
The manufacturer is continually working on the further development of all types and models. Please be aware that we reserve the right to make changes to the shape, equipment and technology.

| Symbol  | Explanation   |
|---|---|
|  | <b>Read instructions</b><br>Please read the information in these instructions carefully to understand all of the benefits of your new appliance.  |
|  | <b>Full instructions on the internet</b><br>You can find detailed instructions on the internet using the QR code on the front of these instruction or by entering the service number at <a href="http://home.liebherr.com/fridge-manuals">home.liebherr.com/fridge-manuals</a> .<br>The service number can be found on the serial tag:<br><br><i>Fig. Example illustration</i> |
|  | <b>Check appliance</b><br>Check all parts for transport damage. If you have any complaints, please contact your agent or customer service.  |

| Symbol   | Explanation   |
|--|---|
|  | <b>Differences</b><br>These instructions apply to a range of models, so differences are possible. Sections that apply to certain models only are marked with an asterisk (*). |
|  | <b>Instructions and results</b><br>Instructions are marked with a ▶.<br>Results are marked with a ▷.  |
|  | <b>Videos</b><br>Videos about the appliances are available on the YouTube channels of Liebherr-Hausgeräte.  |

These operating instructions apply to:

|          |                        |
|----------|------------------------|
| R(D) ... | 42../ 46../ 50../ 52.. |
| Kf/ Ksfe | 46../ 52..             |
| SR ...   | 52..                   |

## 1 Appliance at a glance

### 1.1 Scope of delivery

Check all parts for damage during transport. If you have any complaints, please contact your retailer or Customer Services (see 9.4 Customer Services).

Your new appliance comes with the following parts:

- Standalone appliance
- Features (depending on the model)
- Installation materials (depending on the model)
- "Quick Start Guide"
- "Installation Guide"
- Service Brochure

### 1.2 Overview of the appliance and features

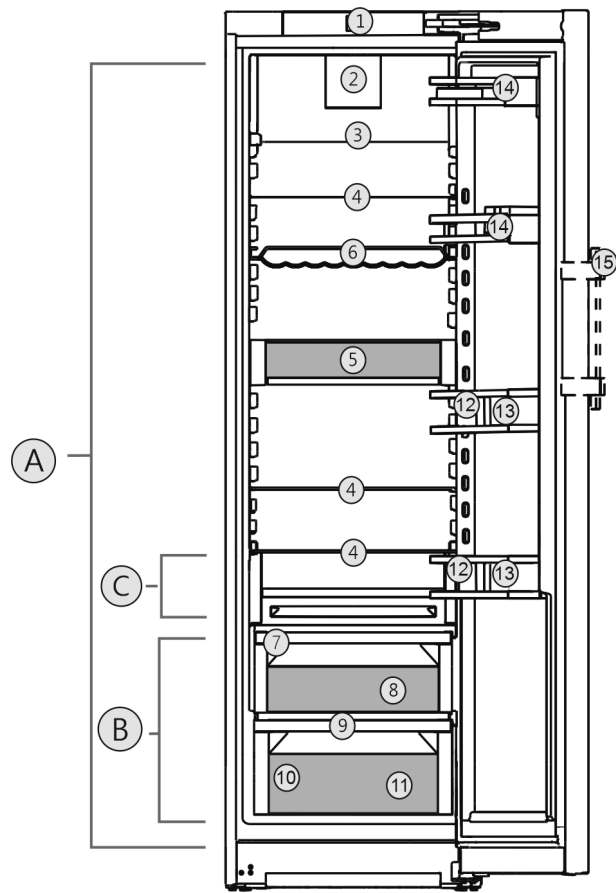

Fig. 1 Example illustration

#### Temperature range

- (A) Fridge compartment      (B) EasyFresh  
(C) Coldest zone

#### Features

- |   |                        |
|---|------------------------|
| (1) Controls                                    | (9) Outlet             |
| (2) Fan with FreshAir activated charcoal filter | (10) Serial tag        |
| (3) Separable storage shelf*                    | (11) Vegetable drawer* |
| (4) Storage shelf                               | (12) Bottle rack*      |
| (5) VarioSafe*                                  | (13) Bottle holder     |
| (6) Bottle shelf*                               | (14) Can rack          |
| (7) EasyFresh safe cover                        | (15) Lever handle*     |
| (8) EasyFresh safe                              |                        |

#### Note

- ▶ Shelves, drawers and baskets are arranged for optimum energy efficiency when the appliance is delivered. Changing how the shelves, for example, are inserted in the fridge compartment does not have any impact on energy consumption.

### 1.3 Appliance range of use

#### Intended use

The appliance is only suitable for cooling food products in a domestic or household-like environment. This includes, for example, use:

- in staff kitchens, bed and breakfast establishments,

# General safety instructions

- by guests in country houses, hotels, motels and other accommodation,
- for catering and similar services in the wholesale trade.

The appliance is not suitable for freezing food;

The appliance is not suitable as a built-in unit.

All other types of use are not permitted.

## Foreseeable misuse

The following applications are expressly forbidden:

- Storing and refrigerating medicines, blood plasma, laboratory preparations or similar substances and products based on the Medical Device Directive 2007/47/EC
- Use in areas at risk of explosions

Misusing the appliance may lead to damage to the goods stored or they may spoil.

## Climate classifications

Depending on the climate classification the appliance is designed to operate in restricted ambient temperatures. The climate classification applying to your appliance is printed on the rating plate.

### Note

► Keep to the specified ambient temperatures in order to guarantee that the appliance works properly.

| Climate classification | for ambient temperatures of |
|------------------------|-----------------------------|
| SN                     | 10 °C to 32 °C              |
| N                      | 16 °C to 32 °C              |
| ST                     | 16 °C to 38 °C              |
| T                      | 16 °C to 43 °C              |

## 1.4 Conformity

The refrigerant circuit has been tested for leaks. The appliance complies with the applicable safety regulations and with the corresponding directives.

The full text of the EU Declaration of Conformity is available on the following website: [www.Liebherr.com](http://www.Liebherr.com)

## 1.5 EPREL database

Details about energy labelling and ecodesign requirements will be available on the European product database (EPREL) from 1st March 2021. You can access the product database at the following link: <https://eprel.ec.europa.eu/> You will be asked to enter the model ID. You can find the model ID on the nameplate.

# 2 General safety instructions

Please keep these operating instructions in a safe place so you can refer back to them at any time.

If you pass the appliance on, please hand these operating instructions to the next user.

Read these operating instructions carefully before use to ensure safe and correct use of the appliance. Follow the instructions, safety instructions and warning messages included at all times. They are important for ensuring you can operate and install the appliance safely and without any problems.

### Danger for the user:

- This device can be used by children and people with impaired physical, sensory or mental abilities or with a lack of experience and knowledge provided that they are supervised or have received instruction in the safe use of this device, and about the resulting hazards. Children must not play with this appliance. Cleaning and user maintenance work must not be carried out by children without adult supervision. Children aged between 3 and 8 are allowed to load and unload the appliance. Children below the age of 3 must be kept away from the appliance unless they are under continuous adult supervision.
- The socket must be easily accessible so that the appliance can be disconnected quickly from the electricity in an emergency. It must not be located in the area behind the appliance.
- When disconnecting the appliance from the supply, always take hold of the plug. Do not pull the cable.
- In the event of a fault pull out the mains plug or deactivate the fuse.
- Do not damage the mains power cable. Do not operate the appliance with a defective mains power cable.
- Only customer service or other specially trained staff may repair or perform other operations on the appliance.
- Only assemble, connect and dispose of the appliance according to the instructions.

### Fire hazard:

- The coolant used (information on the model plate) is ecofriendly but also flammable. Any leaking coolant may ignite.
  - Do not damage the refrigerant circuit pipes.

- Do not handle ignition sources inside the appliance.
- Do not use electrical appliances inside the appliance (e.g. steam cleaners, heaters, ice cream makers, etc.).
- If the refrigerant leaks: remove any naked flames or ignition sources from the vicinity of the leakage point. Properly air the room. Inform customer services.
- Do not store explosives or sprays using combustible propellants such as butane, propane, pentane, etc. in the appliance. To identify these spray cans, look for the list of contents printed on the can, or a flame symbol. Gases possibly escaping may ignite due to electrical components.
- Keep burning candles, lamps and other items with naked flames away from the appliance so that they do not set the appliance on fire.
- Please be sure to store alcoholic drinks or other packaging containing alcohol in tightly closed containers. Any alcohol that leaks out may be ignited by electrical components.

### Danger of tipping and falling:

- Do not misuse the plinth, drawers, doors etc. as a step or for support. This applies particularly to children.

### Danger of food poisoning:

- Do not consume food which has been stored too long.

### Danger of frostbite, numbness and pain:

- Avoid prolonged skin contact with cold surfaces or refrigerated/frozen goods or take protective measures, e.g wear gloves.

### Danger of injury and damage:

- Hot steam can lead to injury. Do not use electrical heating or steam cleaning equipment, open flames or defrosting sprays to defrost.
- Do not use sharp implements to remove the ice.

### Risk of crushing:

- Do not hold the hinge when opening and closing the door. Fingers may get caught.

### Symbols on the appliance:



This symbol may be located on the compressor. It relates to the oil in the compressor and makes reference to the risk that: Swallowing or inhaling can be fatal. This advice is only relevant to recycling. There is no danger in normal operation.



This symbol is located on the compressor and indicates the danger of flammable materials. Do not remove the sticker.



This or a similar sticker may be located on the rear of the appliance. It refers to the foam-padded panels in the door and/or the housing. This advice is only relevant to recycling. Do not remove the sticker.

### Please note the warning messages and other specific advice in the other chapters:

|  |         |   |
|--|---------|---|
|  | DANGER  | indicates an immediately hazardous situation which will lead to death or serious injuries if it is not avoided. |
|  | WARNING | indicates a hazardous situation which may lead to death or serious injuries if it is not avoided.               |
|  | CAUTION | indicates a hazardous situation which may lead to minor or moderate injuries if it is not avoided.              |
|  | NOTICE  | indicates a hazardous situation which may lead to damage to property if it is not avoided.                      |
|  | Note    | indicates useful instructions and tips.   |

## 3 Putting into operation

### 3.1 Switching on appliance

Ensure that the following conditions are met:

- Appliance is set up and connected according to installation instructions.
- All adhesive strips, adhesive and protective films as well as transport safety devices in and on the appliance are removed.
- All marketing leaflets are removed from the drawers.

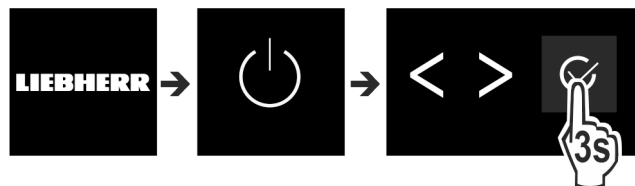

Fig. 2

- ▶ Switch on the appliance using the control panel next to the display.
- ▷ The status display appears.

#### The appliance starts in DemoMode:

If the appliance starts in DemoMode, you can deactivate DemoMode within the next 5 minutes.

# Foods management

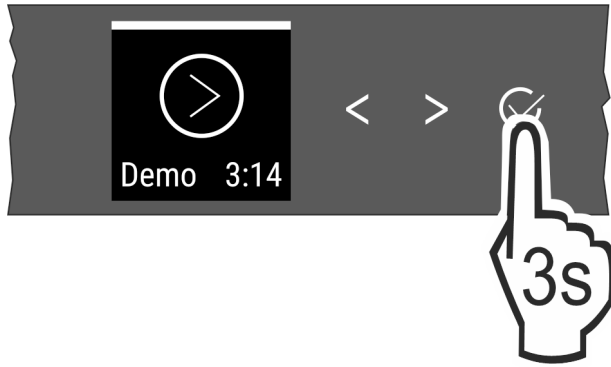

Fig. 3

- ▶ Press Confirm next to the display for 3 seconds.
- ▷ DemoMode is deactivated.

## Note

The manufacturer recommends:

- ▶ Place the food inside: Wait for around 6 hours until the set temperature is reached.

## 3.2 Inserting the components

- ▶ Insert the supplied components to make the most of your appliance.
- ▶ Purchase and install the SmartDevice Box (see [smartdevice.liebherr.com](http://smartdevice.liebherr.com)).
- ▶ Install the SmartDevice app (see [apps.home.liebherr.com](http://apps.home.liebherr.com)).

## Note

You can purchase accessories from the [Liebherr household appliance store](http://Liebherr household appliance store) ([home.liebherr.com](http://home.liebherr.com)).

## 4 Foods management

### 4.1 Storing food



#### WARNING

Risk of fire

- ▶ Do not use any electrical appliances in the food area of the appliance unless recommended by the manufacturer.

## Note

The energy consumption increases and the cooling power goes down if ventilation is not sufficient.

- ▶ Always keep air slots clear.

When storing food, always observe the following:

- Air vents on the inside rear wall are unobstructed.
- Air vents on the fan are unobstructed.
- Food is in sealed packaging.
- Foods that easily absorb or give off smell or taste are stored in sealed containers or covered.
- Raw meat and fish are in clean, sealed containers to prevent them coming into contact with or dripping onto other foods.
- Liquids are in sealed containers.
- Foods are not stored too closely together, as the air needs to circulate.

## Note

Failure to follow these guidelines can lead to food perishing.

### 4.1.1 Fridge section

The natural air circulation creates a range of temperatures.

#### Arrange your food as follows:

- ▶ In the top section and in the door: butter and cheese, preserves and tubes.
- ▶ In the coldest zone *Fig. 1 (C)*: Perishable foods such as ready-to-eat meals, meat and sausages
- ▶ On the bottom shelf: Raw meat and fish

### 4.1.2 EasyFresh-Safe

This compartment is great for non-packaged foods, such as fruit and vegetables.

The air moisture in the compartment depends on the moisture content of the items being stored and the number of times the door is opened. You can adjust the air moisture.

#### Arrange your food as follows:

- ▶ Store your loose fruit and vegetables.
- ▶ Excessive air moisture: Regulate the air humidity (see 7.7 Adjusting the moisture levels).

## 4.2 Storage times

Refer to the specified storage times as a guide.

In the case of foods with a minimum shelf life, the date indicated on the packaging still applies.

### 4.2.1 Fridge section

Always follow the best-before date stated on the packaging.

## 5 Saving energy

- Pay attention to good ventilation. Do not cover ventilation holes or grids.
- Always keep the fan air slits clear.
- Do not install the appliance in direct sunlight, next to an oven, radiator or similar.
- Energy consumption depends on the installation conditions, e.g. the ambient temperature (see 1.3 Appliance range of use). A warmer ambient temperature can increase the energy consumption.
- Open the appliance for as short a time as possible.
- The lower the temperature is set the higher the energy consumption.
- Sort your food: [home.liebherr.com/food](http://home.liebherr.com/food).
- Keep all food properly packed and covered. This prevents frost from forming.
- Only take food out for as long as necessary so that it doesn't warm up too much.
- Inserting warm food: allow to cool down to room temperature first.
- For longer periods of absence, use HolidayMode (see HolidayMode).

## 6 Controls

### 6.1 Controls and displays

The display provides a quick overview of the temperature setting and the status of functions and settings. You can control the functions and settings either by deactivating/activating them or by selecting a value.

## 6.1.1 Status display

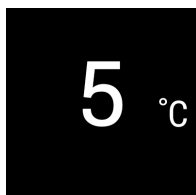

Fig. 4

- (1) Temperature display of the fridge section

The Status display shows the set temperature and is the home display. From there, you can navigate to the options and settings.

## 6.1.2 Navigation

Navigate in the menu to access the individual functions. An audible signal sounds after confirming a function or setting. If no selection is made after 10 seconds the display switches to the Status display.

The appliance is operated with the buttons next to the display.



Fig. 5

- (1) Navigation arrow left/ right (2) Confirm

### Navigation arrow left/right Fig. 5 (1):

- Navigating in the menu. After the last menu page, it goes back to the first one.

### Confirm Fig. 5 (2):

- Activating/deactivating a function.
- Open a submenu.
- Confirm a selection. After confirmation the display switches back to the menu.

### Back to Status display: in the fastest manner:

- Close and open the door.
- or wait 10 seconds. The display switches to the Status display.

## 6.1.3 Operating structure

The controls are explained by a template. The display changes depending on the function or settings.

### Menu without a submenu

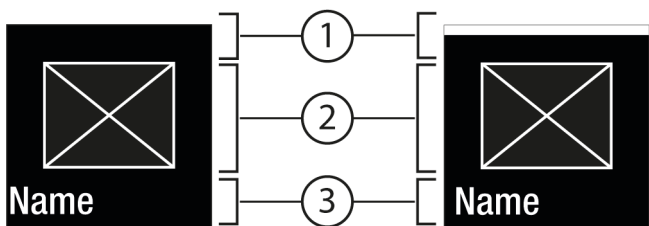

Fig. 6

- (1) Status deactivated / status activated white bar in the top area  
 (2) Symbol or activated value  
 (3) Menu: Function name or menu: Setting name

### Menu with a submenu

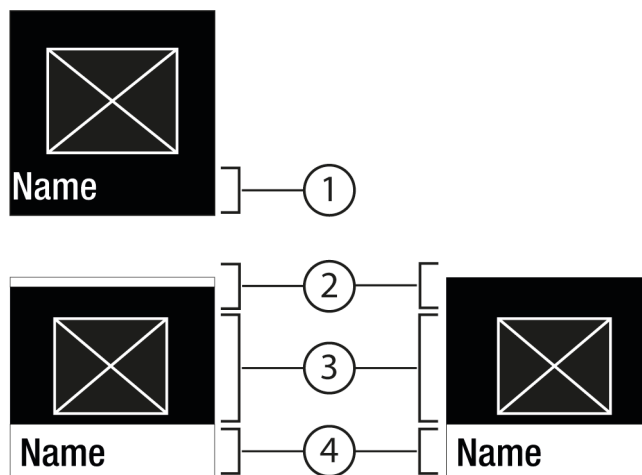

Fig. 7

- (1) Menu: Function name or menu: Setting name  
 (2) Status  
 (3) Symbol or activated value  
 (4) Submenu: function name or submenu: Setting name

(2) off / on

You can navigation as follows:

- Press the left/right Fig. 5 (1) arrow to navigate.
- Press Confirm Fig. 5 (2) to open the submenu Fig. 7 (4).
  - Press the left/right Fig. 5 (1) arrow to navigate.
  - Set a new value: Press Confirm Fig. 5 (2) to select an active value Fig. 6 (1).
  - Back to the menu: Press Confirm Fig. 5 (2) to select the active value Fig. 6 (2).

## 6.1.4 Display symbols

Display symbols provide information on the current appliance status:

| Symbol | Appliance status  |
|--------|---|
|        | <b>Standby</b><br>The appliance or temperature zone is switched off.                                |
|        | <b>Flashing number</b><br>Appliance is working. Temperature flashes until the set value is reached. |
|        | <b>Flashing symbol</b><br>Appliance is working. Setting is made.                                    |
|        | <b>Bar grows steadily</b><br>Function is activated.   |





## 6.2 Control concept

### 6.2.1 Activating/deactivating the function

You can activate/deactivate the following functions:

| Symbol | Function   |
|--------|------------|
|        | SuperCool* |

# Controls

| Symbol  | Function                |
|---|-------------------------|
|  | PowerCool <sup>x</sup>  |
|  | PartyMode <sup>x*</sup> |
|  | HolidayMode             |
|  | E-Saver                 |

<sup>x</sup> When function is on, the appliance works harder. This means appliance noise when operating may be louder for a short while, and more energy will be consumed.

- ▶ Press the navigation arrows *Fig. 5 (1)* repeatedly until the function is displayed.
- ▶ Press Confirm *Fig. 5 (2)*.
- ▷ You hear the confirmation tone.
- ▷ Status appears in the menu.
- ▷ Function is on/off.

## 6.2.2 Selecting function value

With the following functions you can set a value in the submenu:

| Symbol   | Function                    |
|--|-----------------------------|
|  | Setting the temperature     |
|  | Switch the appliance on/off |







- ▶ Tap the navigation arrows *Fig. 5 (1)* repeatedly until the function is displayed.
- ▶ Press Confirm *Fig. 5 (2)*.
- ▶ Select the setting value with the navigation arrows *Fig. 5 (1)*.

### Setting the temperature

- ▶ Press Confirm *Fig. 5 (2)*.
- ▷ You hear the confirmation tone.
- ▷ Status: On *Fig. 6 (1)* appears briefly in the submenu *Fig. 7 (4)*.
- ▷ Display switches back to the menu.

## 6.2.3 Activating/deactivating settings

You can activate/deactivate the following settings:

| Symbol  | Setting                    |
|---|----------------------------|
|  | WiFi <sup>1</sup>          |
|  | Entry lock <sup>2</sup>    |
|  | SabbathMode <sup>2</sup>   |
|  | Cleaning Mode <sup>2</sup> |
|  | Reminders <sup>1</sup>     |
|  | Reset <sup>2</sup>         |

| Symbol  | Setting                 |
|---|-------------------------|
|  | Switch off <sup>2</sup> |

- ▶ Tap the navigation arrows *Fig. 5 (1)* repeatedly until the  settings appear.
- ▶ Press Confirm *Fig. 5 (2)*.
- ▶ Tap the navigation arrows *Fig. 5 (1)* repeatedly until the desired setting is displayed.

### <sup>1</sup> Activate setting (shortpress)



- ▶ Press Confirm *Fig. 5 (2)*.
- ▷ You hear the confirmation tone.
- ▷ Status appears in the menu.
- ▷ Setting is on / off.

### <sup>2</sup> Activate setting (longpress)

- ▶ To Confirm *Fig. 5 (2)*, press for 3 seconds.
- ▷ You hear the confirmation tone.
- ▷ Status appears in the menu.
- ▷ Display changes.

## 6.2.4 Selecting the setting value

With the following settings you can set a value in the submenu:



| Symbol  | Settings   |
|---|------------|
|    | Brightness |
|   | Door alarm |
|  | Temp. unit |

- ▶ Tap the navigation arrows *Fig. 5 (1)* repeatedly until settings  appears.
- ▶ Press Confirm *Fig. 5 (2)*.
- ▶ Tap the navigation arrows *Fig. 5 (1)* repeatedly until the desired setting is displayed.
- ▶ Press Confirm *Fig. 5 (2)*.
- ▶ Select the setting value with the navigation arrows *Fig. 5 (1)*.
- ▶ Press Confirm *Fig. 5 (2)*.
- ▷ You hear the confirmation tone.
- ▷ Status appears briefly in the submenu.
- ▷ Display switches back to the menu.

## 6.2.5 Go to the Customer menu

You can see the following settings in the Customer menu:

| Symbol  | Function |
|---|----------|
|  | Software |

- ▶ Press the navigation arrows *Fig. 5 (1)* repeatedly until the settings  appear.
- ▶ Press Confirm *Fig. 5 (2)*.
- ▶ Press the navigation arrows *Fig. 5 (1)* repeatedly until the appliance information  appears in the display.
- ▶ Press Confirm *Fig. 5 (2)*.
- ▶ Enter the numerical code 151.
- ▷ The customer menu appears.
- ▶ Press the navigation arrows *Fig. 5 (1)* repeatedly in the customer menu until the desired setting appears.

### <sup>1</sup> Select the value

- ▶ Press Confirm *Fig. 5 (2)*.

- ▷ You hear the confirmation tone.
- ▷ Status appears briefly in the display.
- ▷ Display switches back to the menu.

## <sup>2</sup> Activate the setting

- ▶ To Confirm Fig. 5 (2), press for 3 seconds.
- ▷ You hear the confirmation tone.
- ▷ Status appears on the display.
- ▷ The symbol flashes as long as the appliance is working.

## 6.3 Functions

### Turn off appliance

This setting turns off the whole appliance.

#### Switching off the entire appliance

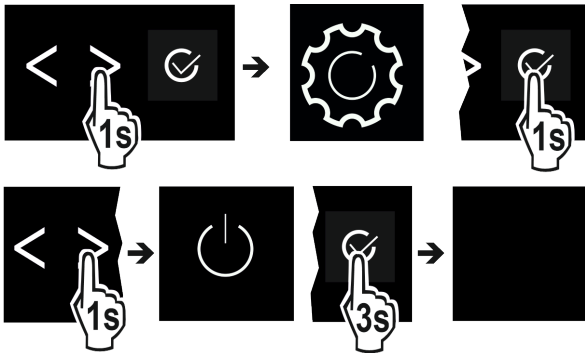

Fig. 8

- ▶ Activating/deactivating (see 6.2 Control concept).
- ▷ Off: Display goes black.

### Connecting to the WLAN

This setting connects the appliance to the internet. The connection is managed in the SmartDevice-Box. You can use the SmartDevice-App to add your appliance to a SmartHome-System. Use the SmartDevice-App or other compatible partner networks to enjoy advanced options and settings.

#### Note

The SmartDevice-Box is available from the [Liebherr Domestic Appliances Shop \(https://home.liebherr.com/shop/de/deu/smartdevicebox.html\)](https://home.liebherr.com/shop/de/deu/smartdevicebox.html).

You can find more information about the availability, prerequisites and the individual options on the Internet under <https://smartdevice.liebherr.com/install>.

#### Use:

- Manage the appliance with the SmartDevice-App or a compatible partner network.
- Enjoy advanced functions and settings.
- Check the current status of the appliance in the SmartDevice-App.

- The SmartDevice Box is purchased and installed (see <https://smartdevice.liebherr.com/install>).
- The SmartDevice app is installed (see <https://apps.home.liebherr.com/>).

### Setting up the connection

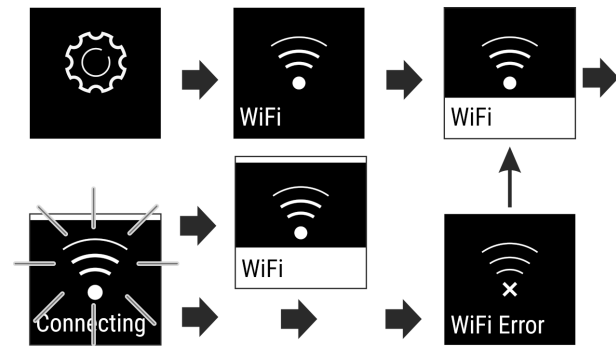

Fig. 9

- ▶ Activating the setting (see 6.2 Control concept).
- ▷ The connection is set up: Status: on Fig. 6 (1) and WiFi connecting appears. The symbol flashes.
- ▷ The connection is set up: Status: on Fig. 6 (1) appears.
- ▷ The connection failed: Status and Connect appears. The symbol appears permanently.

### Disconnecting the appliance

- ▶ Deactivate the setting (see 6.2 Control concept).

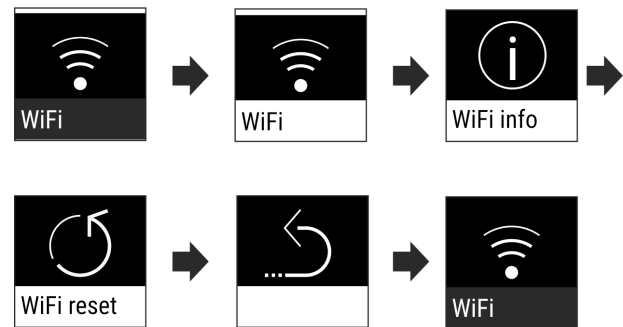



Fig. 10

- ▷ There is no connection: The symbol  is displayed constantly.

### Restoring the connection

- ▶ Restore settings (see 6.2 Control concept).

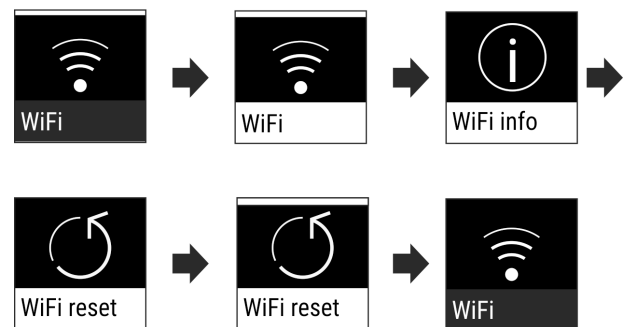

Fig. 11

- ▷ Connection and other settings are restored to factory settings.

### Temperature

The temperature depends on the following factors:

- The amount of times the door is opened
- How long the door is open for
- The room temperature of the installation site
- The type, temperature and amount of food

# Controls

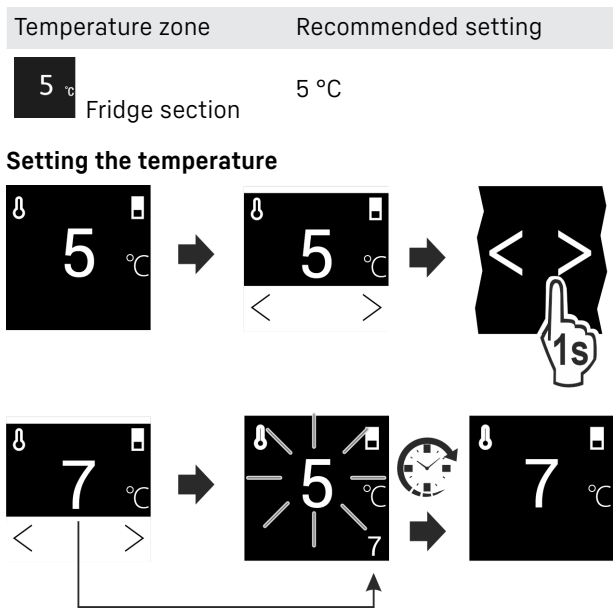

Fig. 12

- ▶ Set the value. (see 6.2 Control concept).
- ▷ Set temperature is shown at the bottom right of the display.

## Temperature unit

This setting enables you to switch between Celsius and Fahrenheit as the temperature unit.

### Selecting the setting value

- ▶ Set the value (see 6.2 Control concept).

## SuperCool

This function selects the lowest cooling temperature. This gives you colder storage temperatures.

This function is relevant to the fridge section Fig. 1 (A)

Use:

- Cool large amounts of food quickly.

### Activating/deactivating the function

- ▶ Using the fridge section: activate the function when you add the goods.
- ▶ Activating/deactivating (see 6.2 Control concept).

The function automatically turns off. The appliance goes back to normal mode. The temperature adjusts itself to the set level.

## PowerCool

This function provides the perfect blanket temperature to cool your food.

This function refers to the fridge section Fig. 1 (A).

Use:

- At higher room temperatures (from approx. 35 °C)
- When humidity is high e.g. on summer days
- When storing moist goods, to avoid condensation building up inside

### Activating/deactivating the function

- ▶ Activating/deactivating (see 6.2 Control concept).

### Note

The fan can run even when function is deactivated. This ensures optimal temperature distribution in the appliance.

- ▷ Function activated: Energy consumption of the appliance is slightly increased.

## PartyMode\*

This option offers an assortment of special functions and settings that are useful if you are having a party.

The following functions are on:

- SuperCool

All the functions can be adjusted flexibly and separately. Changes are discarded when the function turns off.

### Activating/deactivating the function

- ▶ Activating/deactivating (see 6.2 Control concept).
  - ▷ On: All functions are activated at the same time.
  - ▷ Deactivated: Previously set temperatures are restored.
- After 24 hours the function turns off automatically.

## HolidayMode

This function minimises the energy consumption during an extended absence. The temperature of the refrigerator compartment is set to 15 °C and this is displayed on the status screen when the temperature has been reached.

Use:

- Save energy if you plan to be away for a while.
- Avoid coming home to bad smells and mould.

### Activating/deactivating the function

- ▶ Empty everything from the fridge section.
- ▶ Activating/deactivating (see 6.2 Control concept).
- ▷ On: Fridge temperature is raised.
- ▷ Off: the previously set temperature is restored.

## SabbathMode

This setting meets the religious requirements on the Sabbath and Jewish festivals. Turn on SabbathMode to switch off certain controls. This means you can use the appliance without anyone changing the settings.

You can find a list of Star-K-certified appliances at [www.star-k.org/appliances](http://www.star-k.org/appliances).

This appliance has certification from the "Institute for Science and Halacha".

## WARNING

Danger of food poisoning.

If there is a power cut while the appliance is in SabbathMode, this message is not saved. Once power is restored, the appliance continues in SabbathMode. When this mode is over no message about the power cut is displayed on the temperature display.

If there was a power cut during SabbathMode:

- ▶ Check the food for quality. Do not eat the food if it has thawed.

What the appliance does in SabbathMode:

- The Status display continuously shows SabbathMode.
- The display is locked for all functions apart from deactivating SabbathMode.

- Any functions/settings that are already on, remain active.
- The display stays bright when the door is closed.
- Reminders are disabled. The set time intervals are also paused. This function is disabled in SabbathMode.
- Reminders and warnings are not displayed. There are no acoustic signals, and the display does not show warnings or settings such as temperature alarm or door alarm.
- The internal light is off.
- The defrost cycle only works for the specified time without taking account of fridge use.
- After a power cut the appliance automatically returns to SabbathMode.

## Activating/deactivating SabbathMode

- ▶ To activate the function, click the arrows next to the display until you see Settings  in the menu and then confirm. The menu changes to show the available settings.
- ▶ Click the arrows next to the display until you see SabbathMode (Menora) appear. Confirm the symbol.
- ▷ A white bar appears in the top part of the display.
- ▷ SabbathMode is activated.

To deactivate this function, press the button for confirmation next to the display for 3 seconds.

SabbathMode is deactivated.

## E-Saver

This function reduces energy consumption. If you activate this function, the cooling temperature increases.

| Temperature zone  | Recommended setting (see Temperature) | Temperature when E-Saver activated |
|---|---------------------------------------|------------------------------------|
|  Fridge compartment | 5 °C                                  | 7 °C                               |

Use:

- Save energy.

## Activating/deactivating the function

- ▶ Activating/deactivating (see 6.2 Control concept).
- ▷ Activated: Higher temperatures are set in all temperature zones.
- ▷ Deactivated: Previously set temperatures are restored.

## CleaningMode

Use this setting to easily clean the appliance.

This setting refers to the fridge section *Fig. 1 (A)*.

Use:

- Clean the fridge section by hand.

What happens on the appliance when this setting is on:

- The fridge section is switched off.
- The internal light is on.
- Reminders and warnings are not shown. There is no acoustic signal.

## Activating/deactivating settings

- ▶ Activating/deactivating the setting (see 6.2 Control concept).
- ▷ On: fridge section is off. Light stays on.
- ▷ Off: preset temperature is restored.

After 60 min the setting turns off automatically. The appliance then continues running in normal mode.



## Display brightness

Set the brightness level of the display.

You can set the following brightness levels:

- 40%
- 60%
- 80%
- 100%

## Choose the setting

- ▶ Set the level (see 6.2 Control concept).



## Door alarm

Set the time before the door alarm (see Close the door) sounds.

The options are as follows:

- 1 min
- 2 min
- 3 min
- Off

## Choose the setting

- ▶ Set the time (see 6.4 Fault messages).



## Entry lock

This setting prevents unintentional use of the appliance, e.g. by children.

Use:

- Avoid settings being changed unintentionally.
- Avoid the appliance being switched off unintentionally.
- Avoid the temperature being changed unintentionally.

## Activating/deactivating settings

- ▶ Activating/deactivating. (see 6.2 Control concept)



## Info

This setting allows the appliance information to be read out as well as access to the customer menu.

It provides the following information:

- Model name
- Index
- Serial number
- Service number

## Show appliance data

- ▶ Tap the navigation arrows *Fig. 5 (1)* repeatedly until the  settings appear.
- ▶ Press Confirm *Fig. 5 (2)*.
- ▶ Tap the navigation arrows *Fig. 5 (1)* repeatedly until the information is displayed.
- ▶ Read the appliance info.

# Features



## Reminder

Reminders are given out acoustically by a beep and visually by a symbol in the display. The signal gets louder until the alert stops.



## Replace FreshAir active carbon filter

This message appears when the air filter needs replacing.

- ▶ Change the air filter every six months.
- ▶ Confirm the message with OK.
- ▷ The service interval resets.
- ▷ The air filter guarantees the air quality in the fridge.

### Activating the setting

- ▶ Activating/deactivating (see 6.2 Control concept) .



## Reset

This function resets all settings to the factory settings. All settings that you have made thus far will be reset to their original values.

### Activating the setting

- ▶ Activate (see 6.2 Control concept) .

## 6.4 Fault messages

Fault messages appear in the display. There are two categories of fault message:

| Category | Meaning  |
|----------|--|
| Message  | Reminder of general procedures. You can carry out these procedures to eliminate the message.   |
| Warning  | Appears when there are malfunctions. A signal sounds in addition to the display. The signal becomes louder until you acknowledge by tapping the display. You can eliminate simple defects yourself. For more serious defects, you must contact customer service. |

### 6.4.1 Warnings



#### Close the door

This message appears if the door is open for too long.

You can set how long it takes for this message to appear .

- ▶ Stop alarm: Confirm the message.

-or-

- ▶ Close the door.



#### Error

This message appears if there is a fault with the appliance. An appliance component indicates a fault.

- ▶ Open the door.
- ▶ Note down the fault code.
- ▶ Confirm the message.
- ▷ The signal tone stops.
- ▷ The status display appears.
- ▶ Close the door.
- ▶ Contact customer service. (see 9.4 Customer Services)

### 6.4.2 DemoMode

If "D" appears on the display, demo mode is on. This option is designed for retailers, as it turns off all the cooling functions.

### Stopping DemoMode

If you see the following running in the display:

- ▶ Confirm the display within the countdown.
- ▷ DemoMode is off.
- If the timer is not running:
- ▶ Unplug the appliance.
- ▶ Plug the appliance in again.
- ▷ DemoMode is off.

## 7 Features

### 7.1 Door rack

#### 7.1.1 Move/remove the door rack

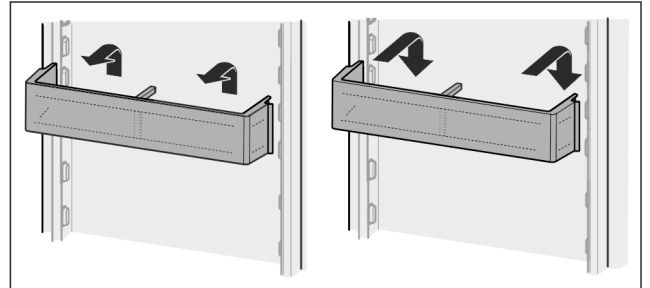

Fig. 13

- ▶ Slide the rack upwards.
- ▶ Pull forwards.
- ▶ Re-insert it in reverse order.

#### 7.1.2 Disassembling the door rack

The door rack can be taken apart for cleaning.

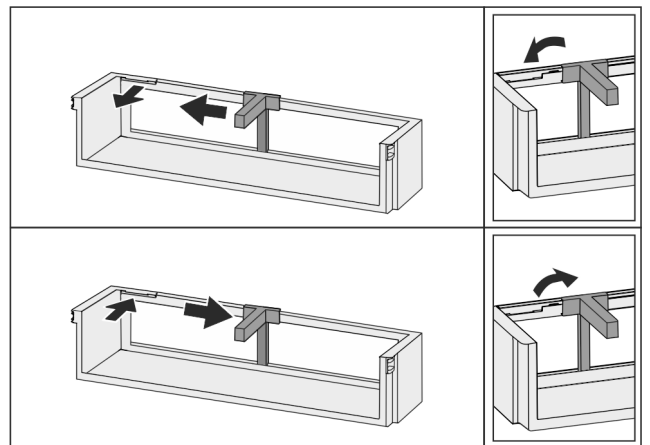

Fig. 14

- ▶ Disassemble the door rack.

## 7.2 Shelves

### 7.2.1 Adjusting/removing the shelves

The shelves are prevented from being pulled out accidentally by pull out stops.

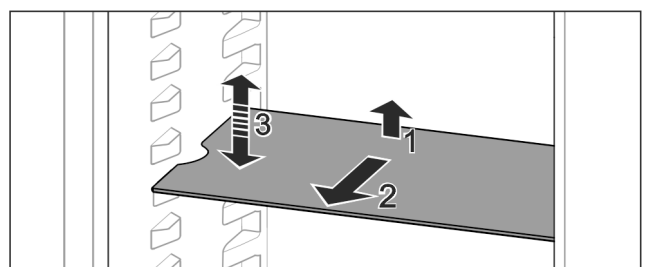

Fig. 15

- ▶ Lift the shelf and pull forward.
- ▷ Line up the side runner.
- ▶ Adjust the height of the shelf: Lift or lower it to the desired height and slide it in.

-or-

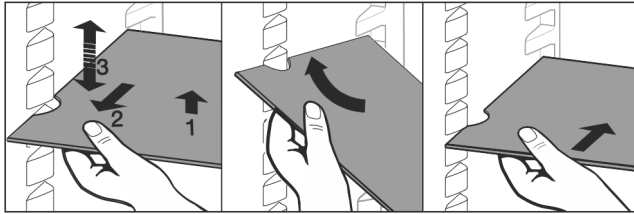

Fig. 16

- ▶ Remove the shelf completely: Pull it out to the front.
  - ▶ Easier removal: Set the shelf at an angle.
  - ▶ Insert the shelf again: Slide it in all the way.
  - ▷ The pull-out stoppers point downwards.
  - ▷ The pull-out stoppers are behind the front support.
- You can also remove the shelf above the EasyFresh compartments.

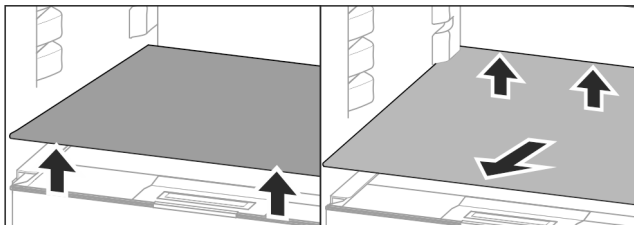

Fig. 17

Removing the shelf:

- ▶ Lift the shelf at the front and back.
- ▶ Pull it out towards you.

Do not store any goods on the compartment cover below!

Inserting the shelf:

- ▶ Place the shelf at an angle, sloping down towards the back.
- ▷ The pull-out stoppers point downwards.
- ▶ Slide the shelf into place.

## 7.2.2 Dismantling the shelves

The shelves can be dismantled for cleaning.

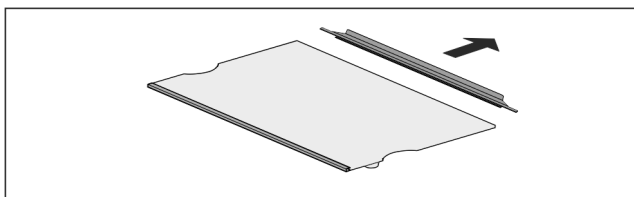

Fig. 18

- ▶ Dismantling the shelf.

## 7.3 Dividing shelf\*

### 7.3.1 Using the dividing shelf

The shelves are prevented from being pulled out accidentally by pull out stops.

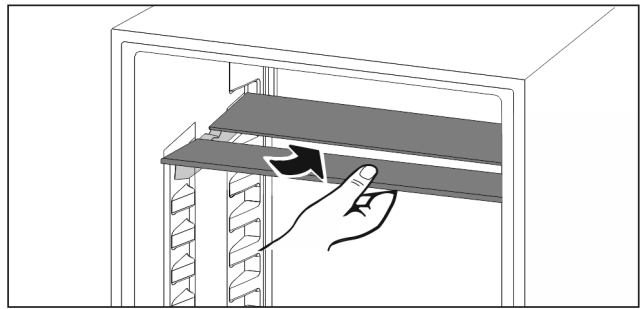

Fig. 19

- ▶ Push the dividing shelf underneath as shown.

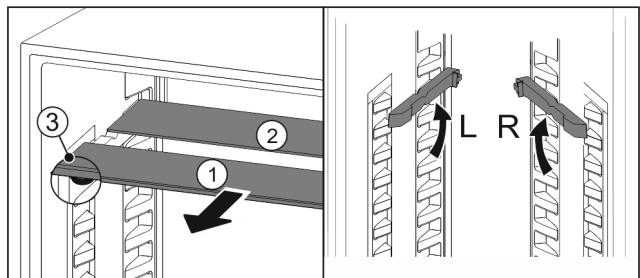

Fig. 20

### Adjusting the height:

- ▶ Pull the glass panels out Fig. 20 (1) from the front, one at a time.
- ▶ Release the support rails and click in at the height you want.
- ▶ Slide in the glass panels one at a time.
- ▷ Flat pull-out stoppers at the front, right behind the support rails.
- ▷ High pull-out stoppers at the back.

### Using both shelves:

- ▶ Hold the glass panel with one hand and pull it to the front.
- ▷ The glass panel Fig. 20 (1) and trim strip are at the front.
- ▷ The stops Fig. 20 (3) point down.

## 7.4 VarioSafe\*

The VarioSafe provides space for compact foodstuffs and packages, pots and glasses.

### 7.4.1 Using the VarioSafe

You can remove the drawer and slide it back in at 2 different heights. This is handy for storing taller items in the drawer.

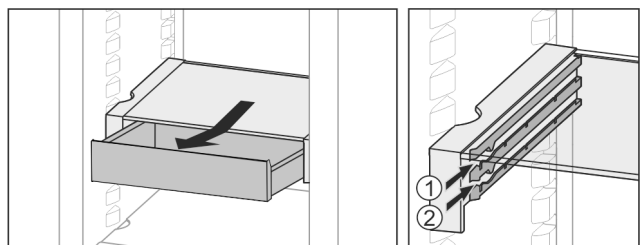

Fig. 21

- ▶ Remove the drawer.
- ▶ Slide back at the height you want Fig. 21 (1) or Fig. 21 (2).

### 7.4.2 Repositioning the VarioSafe

You can shift the height of the entire VarioSafe.

# Features

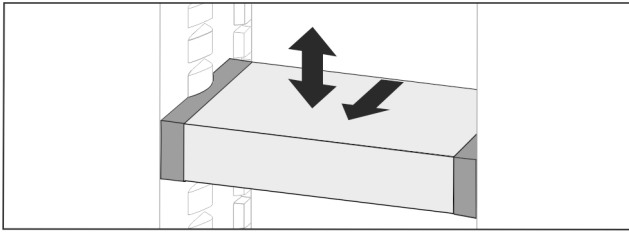

Fig. 22

- ▶ Pull forwards.
- ▷ Line up the side runner.
- ▶ Lift or lower to the height you want.
- ▶ Slide to the rear.

## 7.4.3 Removing the entire VarioSafe

You can remove VarioSafe as a whole unit.

- ▶ Pull forwards.
- ▷ Line up the side runner.

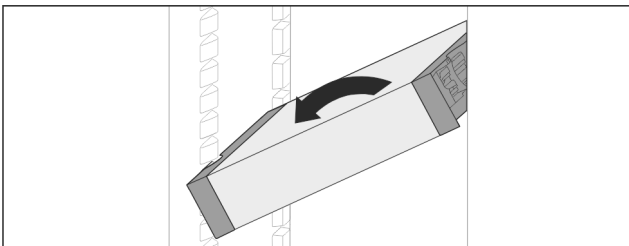

Fig. 23

- ▶ Tip to the side and pull towards you.

## 7.4.4 Disassembling the VarioSafe

You can take the VarioSafe apart for cleaning.

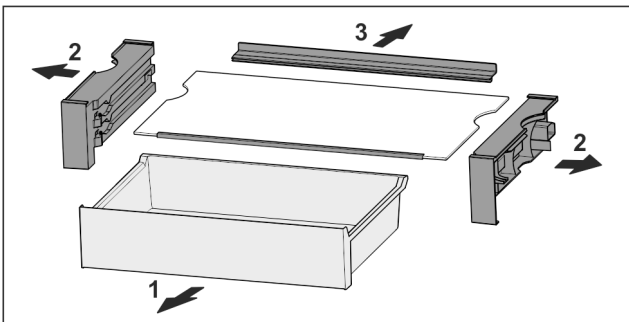

Fig. 24

- ▶ Disassembling the VarioSafe

## 7.5 Drawers

You can remove the drawers for cleaning.

The way to remove/insert the drawers varies depending on the pull-out system. Your appliance can contain various pull-out systems.

### Note

The energy consumption increases and the cooling power goes down if ventilation is not sufficient.

- ▶ Always leave the fan air vents clear on the back wall!

## 7.5.1 Drawer on rails

### Removing drawer

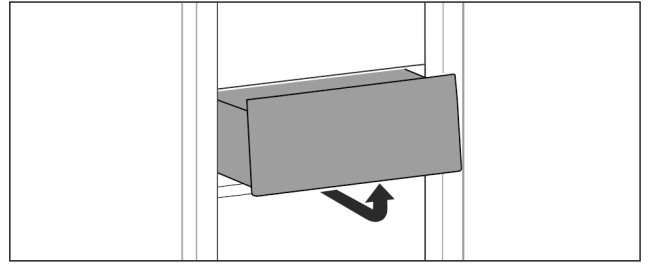

Fig. 25

- ▶ Remove drawer as shown in the illustration.

### Inserting drawer

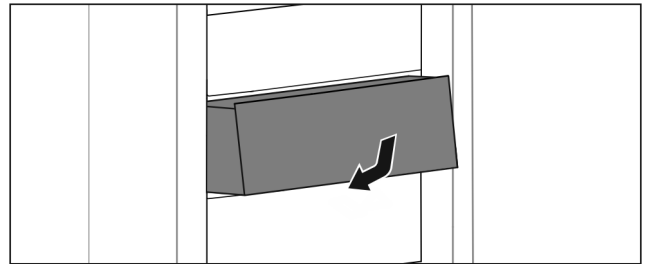

Fig. 26

- ▶ Insert drawer as shown in the illustration.

## 7.6 EasyFresh-Safe cover

You can remove the compartment cover for cleaning.

### 7.6.1 Removing the compartment cover

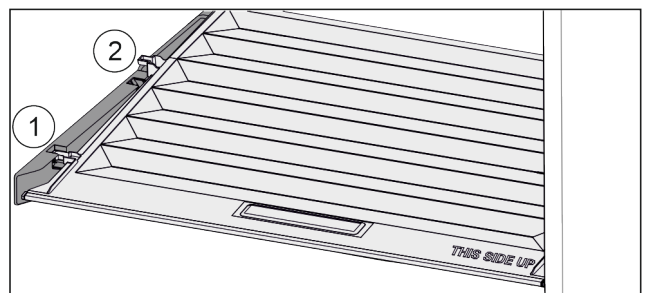

Fig. 27

When the drawers are removed:

- ▶ Pull the lid up at the front to the opening in the retaining parts Fig. 27 (1).
- ▶ Lift from the back and pull it up and out Fig. 27 (2).

### 7.6.2 Inserting the compartment cover

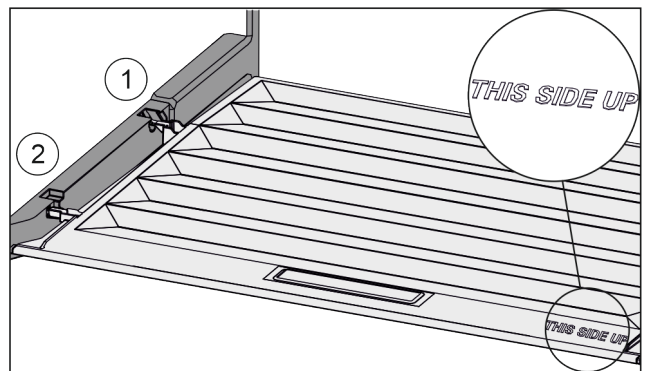

Fig. 28

If the text THIS SIDE UP points upwards:

- ▶ Insert the lip of the cover over the opening of the rear bracket *Fig. 28 (1)* and click into place *Fig. 28 (2)*.
- ▶ Position the cover where you want it (see 7.7 Adjusting the moisture levels).

## 7.7 Adjusting the moisture levels

You can adjust the moisture in the drawer yourself by adjusting the compartment cover.

The compartment lid is attached to the drawer and can be hidden by a shelf or additional drawers.

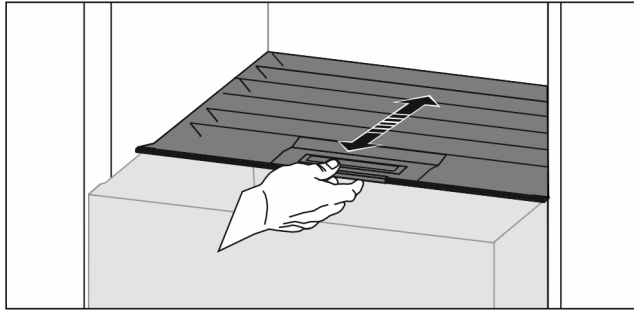

*Fig. 29*

### Low air humidity

- ▶ Open the drawer.
- ▶ Slide the compartment cover forwards.
- ▷ With the drawer closed: Gap between the cover and the compartment.
- ▷ The air moisture in the Safe decreases.

### High air moisture

- ▶ Open the drawer.
- ▶ Slide the cover back.
- ▷ With the drawer closed: The cover seals the compartment.
- ▷ The air moisture in the Safe increases.
- If there is too much moisture in the compartment:
- ▶ Choose the setting "low air moisture".

-or-

- ▶ Remove any excess moisture with a cloth.

## 7.8 Pull-out board with bottle basket\*

Removable bottle baskets on the pull-out board offer plenty of space to store bottles. You can remove the bottle baskets to make room for a drinks crate in the pull-out board.

### 7.8.1 Using the bottle basket

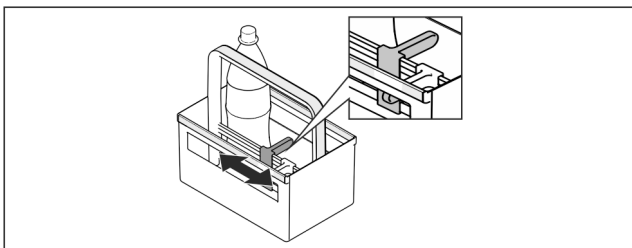

*Fig. 30*

- ▶ Slide the bottle rack at the edges.
- ▷ The bottles are prevented from falling over.

### 7.8.2 Disassembling the pull-out board

The pull-out board is mounted on a glass panel with pull-out rails.

You can dismantle the pull-out board for cleaning.

#### Removing the pull-out board

- ▶ Remove the bottle baskets.

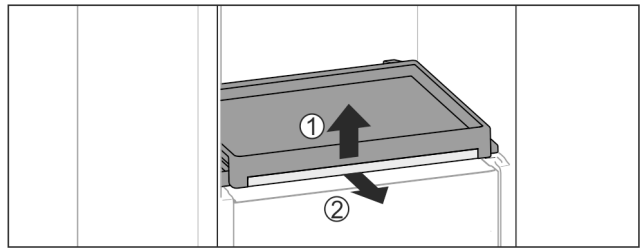

*Fig. 31*

- ▶ To remove the pull-out board with glass panel: Gently lift the glass panel at the front *Fig. 31 (1)* and pull out to the front *Fig. 31 (2)*.

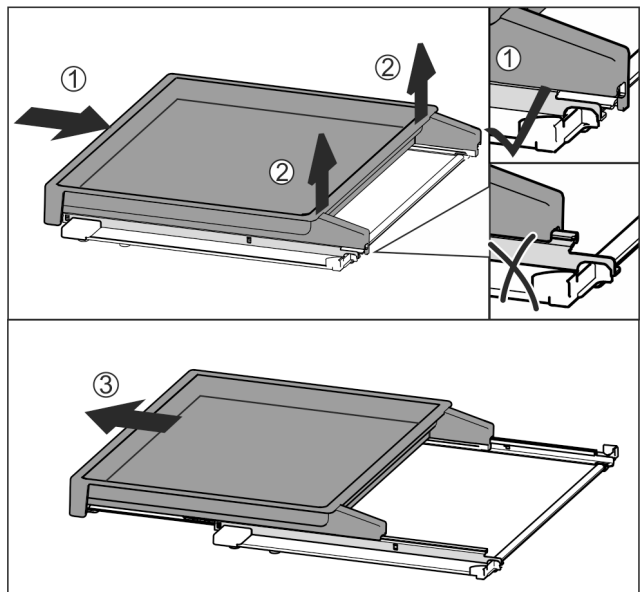

*Fig. 32*

- ▶ Slide the pull-out board all the way in *Fig. 32 (1)*.
- ▶ Release the clips at the back *Fig. 32 (2)*.
- ▶ Remove the pull-out board from the front *Fig. 32 (3)*.

#### Inserting the pull-out board

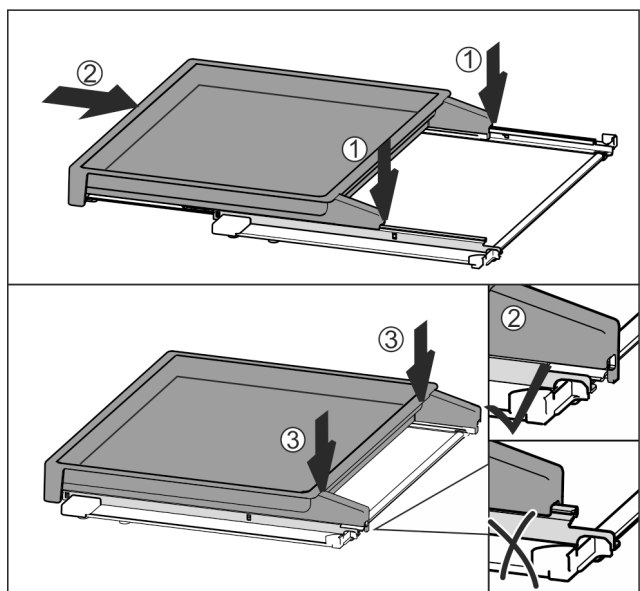

*Fig. 33*

- ▶ Place centrally on the rails *Fig. 33 (1)*.
- ▶ Slide the pull-out board all the way in *Fig. 33 (2)*.
- ▶ Press down at the back until it clicks into place *Fig. 33 (3)*.
- ▶ To insert the pull-out board with glass panel: Slide to the rear.

# Maintenance

## 7.9 Glass shelves

You can remove the glass shelves under the drawers for cleaning.

### 7.9.1 Removing / inserting the glass shelf

Make sure that the following requirements are fulfilled:

- ❑ Glass shelf under the drawer: The drawer has been removed. (see 7.5 Drawers)
- ❑ Pull-out board under the bottle basket: Bottle basket has been removed. (see 7.8 Pull-out board with bottle basket\*) \*

#### Removing glass shelf

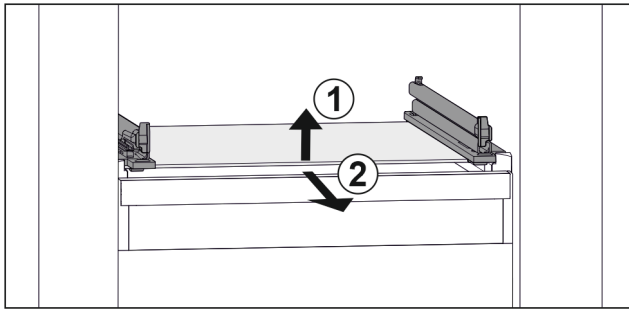

Fig. 34 Example illustration of glass shelf

- ▶ Lift glass shelf at the front. Fig. 34 (1)
- ▶ Take out glass shelf to the front. Fig. 34 (2)

#### Inserting glass shelf

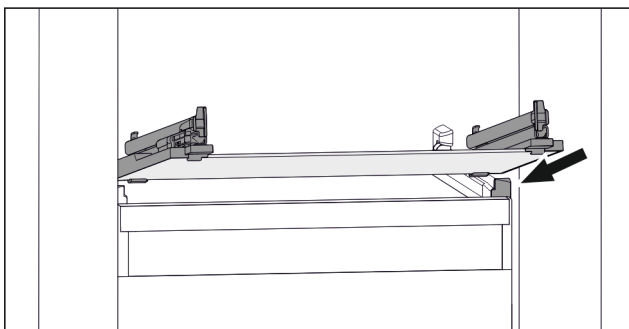

Fig. 35 Example illustration of glass shelf

- ▶ Position glass shelf at an angle behind the stoppers. (see Fig. 917)
- ▶ Lower glass shelf.
- ▶ Slide in glass shelf to the back.

## 7.10 Accessories

### 7.10.1 Bottle holder

#### Using the bottle holder

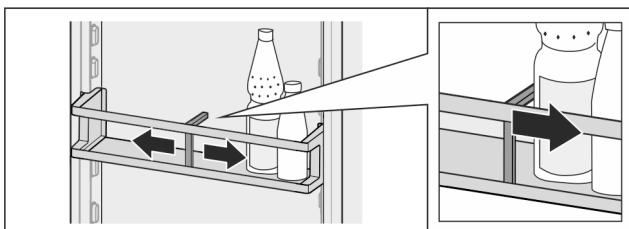

Fig. 36

- ▶ Push the bottle holder onto the bottles.
- ▷ The bottles are prevented from falling over.

#### Removing the bottle holder

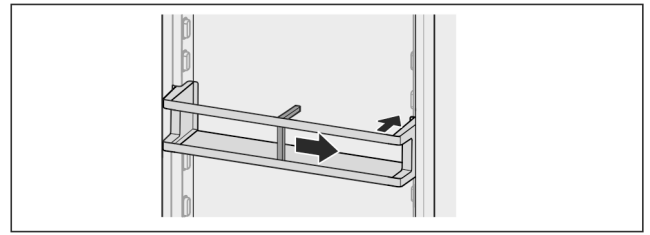

Fig. 37

- ▶ Move the bottle holder all the way to the right.
- ▶ Push the bottle holder to the back to remove.

## 8 Maintenance

### 8.1 FreshAir carbon filter

The FreshAir carbon filter is in the compartment above the fan.

It guarantees the best air quality.

- ❑ Replace the carbon filter every 6 months.  
With the *Reminder* setting on, a message on the display prompts you to replace it.
- ❑ The carbon filter can be disposed of with the regular household waste.

#### Note

You can purchase the FreshAir carbon filter from the [Liebherr household appliance store](http://home.liebherr.com) (home.liebherr.com).

#### 8.1.1 Removing the FreshAir carbon filter

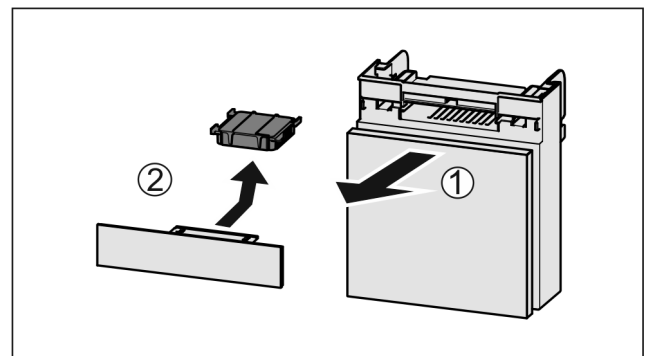

Fig. 38

- ▶ Pull out the compartment Fig. 38 (1).
- ▶ Remove the carbon filter Fig. 38 (2).

#### 8.1.2 Inserting the FreshAir carbon filter

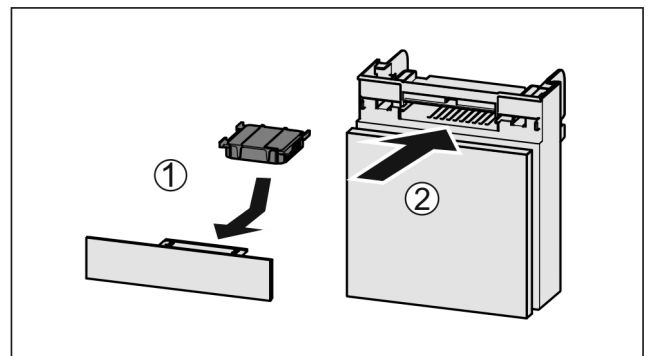

Fig. 39

- ▶ Insert the carbon filter as shown in the diagram Fig. 39 (1).
- ▷ The carbon filter clicks into place.

If the carbon filter is pointing downwards:

- ▶ Push the compartment in *Fig. 39 (2)*.
- ▷ The carbon filter is now ready for use.

## 8.2 Disassembling / assembling pull-out systems

### 8.2.1 Notes on disassembly

You can disassemble some of the pull-out systems for cleaning. Your appliance can contain a variety of pull-out systems.

The following pull-out systems can be disassembled or cannot be disassembled:

| Pull-out system                    | can be disassembled / cannot be disassembled                         |
|------------------------------------|--|
| Drawer on rails                    | cannot be disassembled   |
| Pull-out board with bottle basket* | can be disassembled (see 8.2.2 Pull-out board with bottle basket*) * |

### 8.2.2 Pull-out board with bottle basket\*

#### Disassembling pull-out system

Make sure the following prerequisites are met:

- Bottle basket has been removed. (see 7.8 Pull-out board with bottle basket\*)
- Glass shelf has been removed. (see 7.9 Glass shelves)

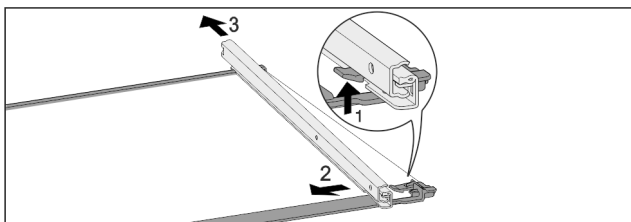

*Fig. 40 Glass shelf with rails*

- ▶ Push up front click-in hooks. *Fig. 40 (1)*
- ▶ Move the pull-out rails to the side *Fig. 40 (2)* and to the rear *Fig. 40 (3)*.

#### Installing pull-out system

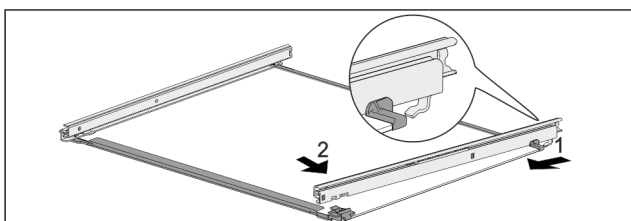

*Fig. 41 Glass shelf with rails*

- ▶ Hook in rail at the back. *Fig. 41 (1)*
- ▶ Hook in rail at the front. *Fig. 41 (2)*

## 8.3 Defrosting the appliance



### WARNING

Improper defrosting of the appliance!  
Injuries and damage.

- ▶ Do not use mechanical equipment or other methods to speed up the defrosting process other than those recommended by the manufacturer.
- ▶ Do not use electrical heating or steam-cleaning appliances, naked flames or defroster sprays to defrost.
- ▶ Do not use sharp objects to remove ice.

Defrosting is performed automatically. The water from the thawing process drains through the outlet and evaporates.

Water drops or a thin layer of frost or ice can form on the back wall; this is a completely normal part of the appliance's function. This must not be removed.

A layer of frost or ice can form briefly due to the energy-optimised control of the device.

- ▶ Clean the drain opening regularly (see 8.4 Cleaning the appliance).

## 8.4 Cleaning the appliance

### 8.4.1 Ready



### WARNING

Danger of electric shock!

- ▶ Remove the refrigerator connector or interrupt the power supply.



### WARNING

Risk of fire

- ▶ Do not damage the refrigeration circuit.

- ▶ Empty the appliance.
- ▶ Remove mains connector.

-or-

- ▶ Activate CleaningMode. (see CleaningMode)

### 8.4.2 Clean the housing

#### NOTICE

Improper cleaning!  
Damage to the appliance.

- ▶ Only use soft cleaning cloths and ph-neutral all-purpose cleaners.
- ▶ Do not use abrasive sponges or steel wool which may cause scratches.
- ▶ Do not use any sharp or abrasive cleaning agents, nor any that contain sand, chloride or acid.



### WARNING

Risk of injury and damage as a result of hot steam!  
Hot steam can lead to burns and can damage the surfaces.

- ▶ Do not use any steam cleaners!

- ▶ Wipe the housing down with soft, clean cloth. If very dirty, use lukewarm water with a neutral cleaner. Glass surfaces can also be cleaned with glass cleaner.

### 8.4.3 Cleaning the interior

#### NOTICE

Improper cleaning!  
Damage to the appliance.

- ▶ Only use soft cleaning cloths and ph-neutral all-purpose cleaners.
- ▶ Do not use abrasive sponges or steel wool which may cause scratches.
- ▶ Do not use any sharp or abrasive cleaning agents, nor any that contain sand, chloride or acid.

- ▶ Plastic surfaces: clean by hand with a soft clean cloth, lukewarm water and a little detergent.
- ▶ Metal surfaces: clean by hand with a soft clean cloth, lukewarm water and a little detergent.
- ▶ Drain outlet *Fig. 1 (9)*: remove any deposits with a thin item such as a cotton bud.

# Customer help

## 8.4.4 Clean the components

### NOTICE

Improper cleaning!

Damage to the appliance.

- ▶ Only use soft cleaning cloths and ph-neutral all-purpose cleaners.
- ▶ Do not use abrasive sponges or steel wool which may cause scratches.
- ▶ Do not use any sharp or abrasive cleaning agents, nor any that contain sand, chloride or acid.

**Clean with a soft, clean cloth, lukewarm water and some detergent:**

- Door rack
- Shelf
- Dividing shelf\*
- VarioSafe\*
- Bottle basket and pull-out panel\*
- EasyFresh-Safe cover
- Drawer

**Wash in the dishwasher up to 60 °C:**

- Bottle rack
- Holder of the dividing shelf\*
- ▶ To disassemble components: see the relevant section.
- ▶ Clean the components.

## 8.4.5 After cleaning

- ▶ Wipe the appliance and the components dry.
- ▶ Connect and switch on the appliance. The temperature is cold enough:
- ▶ Place the food inside.
- ▶ Repeat cleaning regularly.

# 9 Customer help

## 9.1 Technical specifications

| Temperature range |              |
|-------------------|--------------|
| Cooling           | 2 °C to 9 °C |

| Maximum component capacity |  |  |  |
|----------------------------|--|--|--|
| Features                   | Appliance width 550 mm (see installation instructions, appliance dimensions) | Appliance width 600 mm (see installation instructions, appliance dimensions) | Appliance width 700 mm (see installation instructions, appliance dimensions) |
| Pull-out board*            | 20 kg*   | 20 kg*   | 20 kg*   |

| Lighting   |              |
|--|--------------|
| Class <sup>1</sup>   | Light source |
| This product contains a light source that meets energy efficiency rating G | LED          |

<sup>1</sup> The appliance may contain light sources with different energy efficiency classes. The lowest energy efficiency class is indicated.

## 9.2 Operating noises

The appliance makes different noises when it is on.

- At **higher temperatures** the appliance uses less energy but works for longer. It is **quieter**.
- At **lower temperatures** the food is cooled faster. It is **louder**.

Examples:

- Functions on (see 6.3 Functions)
- Fan running
- Food recently added
- High ambient temperature
- Door open for a while

| Noise                  | Possible cause  | Type of noise          |
|------------------------|---|------------------------|
| Bubbling and splashing | Coolant flowing into the cooling circuit.                           | Normal operating noise |
| Hissing                | Coolant sprays into the cooling circuit.                            | Normal operating noise |
| Humming                | The appliance is cooling. The volume depends on the cooling output. | Normal operating noise |
| Suction noises         | Soft-closing door is being opened and closed.                       | Normal operating noise |
| Humming and rustling   | The fan is running.   | Normal operating noise |
| Clicking               | Components are switched on and off.                                 | Normal switching noise |
| Rattling humming or    | Valves or flaps are working.  | Normal switching noise |
| Faint knocking         | The valve is active.  | Normal operating noise |
| Humming or buzzing     | The valve is active.  | Normal operating noise |

| Noise     | Possible cause                         | Type of noise   | Lifting  |
|-----------|--|-----------------|--|
| Vibration | Improper setup                         | Defective noise | Level the appliance using the adjustable feet.           |
| Rattling  | Components, items inside the appliance | Defective noise | Secure components. Leave enough space between the items. |

## 9.3 Technical fault

Your appliance is designed and built to ensure it works reliably and has a long service life. In the unlikely event that a fault occurs during operation, please check whether it is due to an operating error. If so, you will be charged for the callout and repair costs even if it falls within the warranty period.

You can fix the following faults yourself.

## 9.3.1 Appliance function

| Defect  | Cause   | Remedy   |
|---|---|--|
| <b>The appliance is not working.</b>  | → The appliance is not switched on.   | ▶ Switch the appliance on.   |
|   | → The power plug is not properly plugged into the socket.                               | ▶ Check the power plug.  |
|   | → There is something wrong with the power outlet fuse.                                  | ▶ Check the fuse.  |
|   | → Power cut   | ▶ Keep the appliance closed.<br>▶ Protecting food: Lay freezer packs on top of the food or use another freezer if the power is off for a prolonged period.<br>▶ Do not re-freeze defrosted food, |
|   | → The appliance plug does not fit the appliance properly.                               | ▶ Check the appliance plug.  |
| <b>Temperature is not cold enough.</b>  | → The appliance door is not closed properly.  | ▶ Close the appliance door.  |
|   | → Not enough ventilation.   | ▶ Keep ventilation grille clear, and clean it.   |
|   | → The ambient temperature is too high.  | ▶ Solution: (see 1.3 Appliance range of use) .   |
|   | → The appliance was opened too many times or for too long.                              | ▶ Wait to see if the required temperature corrects itself. If not, contact Customer Service (see 9.4 Customer Services) .  |
|   | → The temperature is set incorrectly.   | ▶ Turn down the temperature and check after 24 hours.  |
|   | → The appliance is too close to a heat source (oven, radiator, etc).                    | ▶ Move the appliance or the heat source.   |
| <b>The door seal is defective or needs to be replaced for another reason.</b> | → The door seal can be replaced. It can be replaced without the need for special tools. | ▶ Contact Customer Services (see 9.4 Customer Services) .  |
| <b>The appliance builds up too much ice or condensation.</b>                  | → The door seal may have slipped out of its groove.                                     | ▶ Check that the door seal is well fitted in the groove.   |
| <b>The appliance is hot to touch on the outside*.</b>                         | → The heat of the refrigeration circuit is used to avoid condensation.                  | ▶ This is normal.  |

## 9.3.2 Features

| Defect                                      | Cause   | Remedy  |
|---|---|---|
| <b>The internal light does not come on.</b> | → The appliance is not switched on.                       | ▶ Switch the appliance on.  |
|   | → The door was open for longer than 15 minutes.           | ▶ Interior lighting turns off automatically after approx. 15 min. with the door open. |
|   | → The LED interior light is faulty or the lid is damaged. | ▶ Contact customer service (see 9.4 Customer Services) .                              |

## 9.4 Customer Services

First check if you can fix the error yourself (see 9 Customer help) . If you can't, contact Customer Services.

Please refer to the enclosed "Liebherr-Service" brochure for the address.

# Shutting down



## WARNING

Unprofessional repair!  
Injuries.

- ▶ Have any repairs and action - not expressly specified - on the appliance and mains cable carried out by service personnel only. (see 8 Maintenance)
- ▶ A damaged mains cable may only be replaced by the manufacturer, the manufacturer's Customer Service or a similarly qualified person.
- ▶ In the case of appliances with an IEC connector, the change may be made by the customer.

### 9.4.1 Contact Customer Services

Make sure you have the following appliance data at the ready:

- Appliance name (model and index)
  - Service no. (Service)
  - Serial no. (S no.)
  - ▶ Look up the appliance information on the display (see Info).
- or-**
- ▶ Referring to appliance info on the nameplate (see 9.5 Model plate).
  - ▶ Note down the appliance information.
  - ▶ Notify Customer Services of the following: Give us the appliance data.
  - ▷ This will help us to provide you with a faster, more accurate service.
  - ▶ Follow any further instructions given by Customer Services.

### 9.5 Model plate

The model plate is behind the drawers on the inside of the appliance.

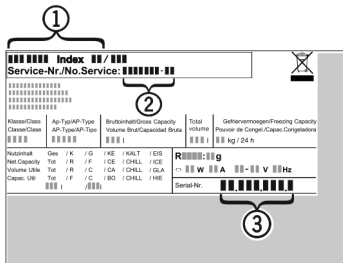

Fig. 42

- (1) Appliance description      (3) Serial no.
- (2) Service no.
- ▶ Note the data on the model plate.

## 10 Shutting down

- ▶ Empty the appliance.
- ▶ Turn off the appliance.
- ▶ Remove mains connector.
- ▶ Remove appliance connector if required: Remove and move from left to right at the same time.
- ▶ Clean the appliance (see 8.4 Cleaning the appliance).
- ▶ Leave the door open to avoid bad smells building up.

## 11 Disposal

### 11.1 Preparing appliance for disposal



**Li-Ion**

Liebherr uses batteries in some of its appliances. In the EU, for environmental reasons, legislation obliges the end user to remove these batteries before disposing of old appliances. If your appliance contains batteries, a corresponding notice is attached.

**Lamps** If you can remove the lamps yourself without destroying them, also remove these before disposal.

- ▶ Take the appliance out of operation.
- ▶ Appliances with batteries: remove the batteries. For description, see **Maintenance** chapter.
- ▶ If possible: remove lamps without destroying them.

### 11.2 Disposing of the appliance in an environmentally friendly manner



The appliance still contains valuable materials and must be disposed of separately from unsorted municipal waste.



**Li-Ion**



**Li-Ion**

Dispose of batteries separately from the old appliance. To do this, you can return the batteries free of charge to retailers as well as recycling centres and collection centres for recyclable materials.

**Lamps** Dispose of removed lamps via the respective collection systems.

For Germany: You can dispose of the appliance free of charge via the class 1 collection containers at the local recycling and recyclable material collection centres. When purchasing a new fridge/freezer, if the sales area > 400 m<sup>2</sup>, retailers will also take back the old appliance free of charge.



## WARNING

Leaking coolant and oil!  
Fire. The coolant contained in the appliance is eco-friendly, but also flammable. The oil contained in the appliance is flammable. Escaping coolant and oil can ignite if the concentration is high enough and in contact with an external heat source.

- ▶ Do not damage the pipelines of the coolant circuit and the compressor.

- ▶ Transport the appliance without damaging it.
- ▶ Dispose of batteries, lamps and the appliance according to the above specifications.





[home.liebherr.com/fridge-manuals](https://home.liebherr.com/fridge-manuals)

**EN** fridge

Issue date: 20221206

**Part number index: 7080430-02**

Liebherr-Hausgeräte Marica EOOD  
Bezirk Plovdiv  
4202 Radinovo  
Bulgarien