

User Manual

# GETTING STARTED? EASY.



ZDH87A2PW

EN User Manual  
Tumble Dryer

# ZANUSSI

## VISIT OUR WEBSITE TO:

---



Get usage advice, brochures, trouble shooter, service and repair information:  
[www.zanussi.com/support](http://www.zanussi.com/support)

### SAFETY INFORMATION

---

Before beginning the installation and use of this appliance, carefully read the supplied instructions. The manufacturer is not responsible for any injuries or damage that are the result of incorrect installation or usage. Always keep the instructions in a safe and accessible location for future reference.



- Read the supplied instructions.



**Warning:** Risk of fire / Flammable materials.

The appliance contains flammable gas, propane (R290), a gas with a high level of environmental compatibility. Keep fire and ignition sources away from the appliance. Be careful not to cause damage to the refrigerant circuit containing propane.

### CHILDREN AND VULNERABLE PEOPLE SAFETY



**WARNING!**

Risk of suffocation, injury or permanent disability.

- This appliance can be used by children aged from 8 years and above and persons with reduced physical, sensory or mental capabilities or lack of experience and knowledge if they have been given supervision or instruction concerning the use of the appliance in a safe way and understand the hazards involved.
- Children between 3 and 8 years of age and persons with very extensive and complex disabilities shall be kept away from the appliance unless continuously supervised.
- Children of less than 3 years of age should be kept away from the appliance unless continuously supervised.
- Do not let children play with the appliance.
- Keep all packaging away from children and dispose of it appropriately.
- Keep detergents away from children.

- Keep children and pets away from the appliance when the door is open.
- If the appliance has a child safety device, it should be activated.
- Children shall not carry out cleaning and user maintenance of the appliance without supervision.

## **GENERAL SAFETY**

- Do not change the specification of this appliance.
- If the tumble dryer is put on top of a washing machine, use the stacking kit. The stacking kit, available from your authorized vendor, can be used only with the appliance specified in the instructions supplied with the accessory. Read it carefully before installation (refer to the Installation leaflet).
- The appliance can be installed as freestanding or below a kitchen counter with correct space (refer to the Installation leaflet).
- Do not install the appliance behind a lockable door, a sliding door or a door with a hinge on the opposite side, that would prevent the appliance door from being fully open.
- The ventilation opening in the base must not be covered by a carpet, mat, or any floor covering.
- **WARNING:** The appliance must not be supplied through an external switching device, such as a timer, or connected to a circuit that is regularly switched on and off by a utility.
- Connect the mains plug to the mains socket only at the end of the installation process. Make sure that the mains plug is accessible after installation.
- Ensure good air ventilation in the room where the appliance is installed to avoid the backflow of unwanted gases into the room from appliances burning gas or other fuels, including open fires.
- **WARNING:** Do not install the appliance in an environment with no air exchange.

The appliance contains flammable gas, propane (R290), a gas with a high level of environmental compatibility. Keep fire and ignition sources away from the appliance. Be careful not to cause damage to the refrigerant circuit containing propane.

- **WARNING:** In the appliance enclosure or in the built-in structure, keep ventilation opening clear of obstruction.
- **WARNING:** Do not damage the refrigerant circuit.
- If the mains power supply cable is damaged, it must be replaced by the manufacturer, its Authorised Service Centre or similarly qualified persons to avoid an electrical hazard.
- Do not exceed the maximum load of 8 kg (refer to the "Programme chart" chapter).
- Do not use the appliance if items have been soiled with industrial chemicals.
- Wipe away lint or packaging debris that has accumulated around the appliance.
- Do not run the appliance without a filter. Clean the lint filter before or after each use.
- Do not dry unwashed items in the tumble dryer.
- Items that have been soiled with substances such as cooking oil, acetone, alcohol, petrol, kerosene, spot removers, turpentine, waxes and wax removers should be washed in hot water with an extra amount of detergent before being dried in the tumble dryer.
- Items such as foam rubber (latex foam), shower caps, waterproof textiles, rubber backed articles and clothes or pillows fitted with foam rubber pads should not be dried in the tumble dryer.
- Fabric softeners, or similar products, should only be used as specified by the product manufacturer's instructions.
- Remove all objects from items that could be a source of fire ignition such as lighters or matches.
- **WARNING:** Never stop a tumble dryer before the end of the drying cycle unless all items are quickly removed and spread out so that the heat is dissipated.
- Before any maintenance operation, deactivate the appliance and disconnect the mains plug from the socket.

# SAFETY INSTRUCTIONS

## INSTALLATION



Warning: Risk of fire / Flammable materials.

- Remove all the packaging.
- Do not install or use a damaged appliance.
- Follow the installation instructions supplied with the appliance.
- Do not install the appliance in an environment with no air exchange

The appliance contains flammable gas, propane (R290), a gas with a high level of environmental compatibility. Keep fire and ignition sources away from the appliance. Be careful not to cause damage to the refrigerant circuit containing propane.

- Always take care when moving the appliance as it is heavy. Always use safety gloves and enclosed footwear.
- Do not install or use the appliance where the temperature can be lower than 5°C or higher than 35°C.
- The floor area on which the appliance is to be installed must be flat, stable, heat resistant and clean.
- Make sure that there is air circulation between the appliance and the floor.
- Always keep the appliance vertical when it is being moved.
- The rear surface of the appliance must be put against a wall.
- When the appliance is in its permanent position, check if it is levelled correctly with the aid of a spirit level. If it is not, adjust the feet accordingly.

## ELECTRICAL CONNECTION



**WARNING!** Risk of fire and electric shock.

- Connect the mains plug to the mains socket only at the end of the installation. Make sure that there is access to the mains plug after the installation.
- **WARNING:** This appliance is designed to be installed / connected to a grounding connection in the building.
- Make sure that the parameters on the rating plate are compatible with the electrical ratings of the mains power supply.
- Always use a correctly installed shockproof socket.
- Do not use multi-plug adapters and extension cables.

- Do not pull the mains cable to disconnect the appliance. Always pull the mains plug.
- Do not touch the mains cable or the mains plug with wet hands.

## USE



**WARNING!** Risk of injury, electric shock, fire, burns or damage to the appliance.



Warning: Risk of fire / Flammable materials. The appliance contains flammable gas, propane (R290), a gas with a high level of environmental compatibility. Keep fire and ignition sources away from the appliance. Be careful not to cause damage to the refrigerant circuit containing propane.

- This appliance is for household (indoors) use only.
- Do not dry damaged (torn, frayed) items that contain padding or fillings.
- If laundry has been washed with a stain remover, carry out an additional rinse cycle before starting a drying cycle.
- Dry only fabrics that are suitable to dry in the appliance. Follow the cleaning instruction on the item label.
- Do not drink or prepare food with the condensed water/distilled water. It can cause health problems to people and pets.
- Do not sit or stand on the open door of the appliance.
- Do not dry dripping wet clothes in the appliance.

## CARE AND CLEANING



**WARNING!** Risk of injury or damage to the appliance.



Warning: Risk of fire / Flammable materials. The appliance contains flammable gas, propane (R290), a gas with a high level of environmental compatibility. Keep fire and ignition sources away from the appliance. Be careful not to cause damage to the refrigerant circuit containing propane.

- Do not use water spray and steam to clean the appliance.
- Clean the appliance with a moist soft cloth. Use only neutral detergents. Do not use abrasive products, abrasive cleaning pads, solvents or metal objects.

- Be careful when you clean the appliance to prevent damage to the cooling system.

## COMPRESSOR



**WARNING!** Risk of damage to the appliance.

- The compressor and its system in the tumble dryer is filled with a special agent which is free from fluoro-chloro-hydrocarbons. This system must stay tight. The damage of the system can cause a leakage.

## SERVICE

- To repair the appliance contact the Authorised Service Centre.
- Use original spare parts only.
- Concerning the lamp(s) inside this product and spare part lamps sold separately: These lamps are intended to withstand extreme physical conditions in household appliances, such as temperature, vibration, humidity, or are intended to signal information about the operational status of the appliance. They are not intended to be used in other applications and are not suitable for household room illumination.

## DISPOSAL



**WARNING!** Risk of injury or suffocation.



Warning: Risk of fire / Risk of material damage and damage to the appliance.

- Disconnect the appliance from the mains electrical and water supplies.
- Cut off the mains electrical cable close to the appliance and dispose of it.
- The appliance contains flammable gas (R290). Contact your municipal authority for information on how to discard the appliance correctly.
- Remove the door catch to prevent children or pets from becoming trapped in the drum.
- Dispose of the appliance in accordance with local requirements for the disposal of Waste Electrical and Electronic Equipment (WEEE).

# EASY START

## PRODUCT DESCRIPTION

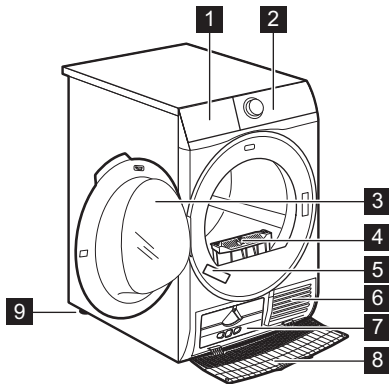

- 1 Water container
- 2 Control panel
- 3 Appliance door
- 4 Filter
- 5 Rating plate
- 6 Airflow slots
- 7 Heat Exchanger lid
- 8 Heat Exchanger cover
- 9 Adjustable feet



For ease of loading laundry or ease of installation the door is reversible. (see separate leaflet).

## CONTROL PANEL

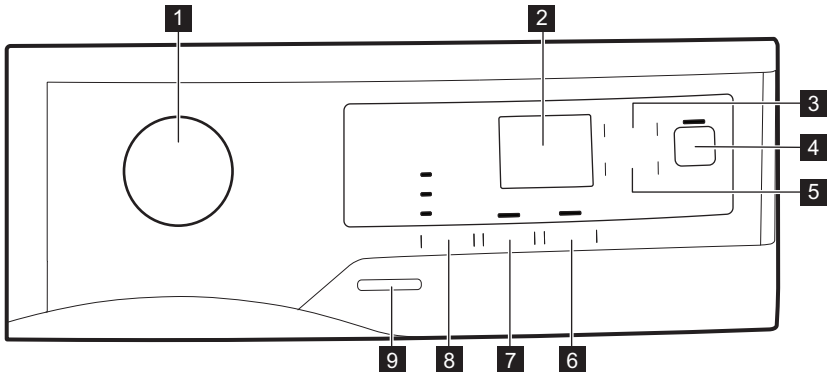

- 1 Programme knob and ● RESET switch
- 2 Display
- 3 Time Dry touch button
- 4 Start/Pause touch button
- 5 Delay Start touch button
- 6 Long Anticrease touch button
- 7 Reverse Plus touch button
- 8 Dryness Level touch button
- 9 On/Off button







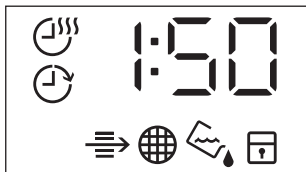

































Press the touch buttons with your finger in the area with the symbol or name of the option. Do not wear gloves when you operate the control panel. Make sure that the control panel is always clean and dry.

## Display



Symbol on the display	Symbol description
	time drying option on
	delay start option on
	indicator: <i>check Heat Exchanger</i>
	indicator: <i>clean filter</i>
	indicator: <i>drain the water container</i>
	child lock on
	wrong selection or knob is in the ● "Reset" position
2 : 0 0	programme duration
: 1 0 - 2 : 0 0	time Drying duration
1 h - 2 0 h	delay start duration

# PROGRAMME TABLE

Programme	Load <sup>1)</sup>	Properties / Fabric type <sup>2)</sup>	
 <sup>3)</sup> Cottons <b>Eco</b>	<b>8 kg</b>	Cycle to be used to dry cotton with "cotton cupboard" dryness level, with maximum energy saving.	/   
Cottons	<b>8 kg</b>	Cycle defined to dry cottons items of different size / different weaving altogether.	/   
Synthetics	<b>3,5 kg</b>	Synthetic and mixed fabrics.	/    
Delicates	<b>4 kg</b>	Delicate fabrics such as viscose, rayon, acrylic, and their blends.	/    
Wool	<b>1 kg</b>	Woollen fabrics. Gentle drying of washable woollens. Remove items immediately when the programme is completed.	
Time Dry	<b>5 kg</b>	With this programme you can use the Time Dry option and set the programme duration. Drying time should be adequate to the load, e.g. 2h for 5 kg of cotton.	/    
Refresh	<b>1kg</b>	Refreshing textiles that were in storage.	
Easy Iron	<b>1 kg (or 5 shirts)</b>	Easy care fabrics for which a minimum of ironing is necessary. The drying results can be different from one type of fabric to another. Shake the items before putting them in the appliance. When the programme has ended, immediately remove the items and put them on a hanger.	/    
Sportswear	<b>2 kg</b>	Sportswear, thin and light fabrics, microfiber, polyester.	/    
Denim	<b>4 kg</b>	Leisure clothing such as jeans, sweat-shirts of different material thicknesses (e.g. at the neck, cuffs and seams).	/    
Bed Linen	<b>3kg</b>	Bed linen such as single and double sheets, pillowcases, duvet cover.	/    
Mix EasyDry	<b>3kg</b>	Cotton and synthetic fabrics. Low temperature programme. Delicate programme with warm air.	/    

1) The maximum weight refers to dry items.



2) For fabric mark meaning see chapter *HINTS AND TIPS: Preparing the laundry*.

3) The  Cottons Cupboard Dry ECO programme is the "Standard cotton programme" according to UK Ecodesign and Energy Labelling Regulations. It is suitable for drying normal wet cotton laundry and it is the most efficient programme in terms of energy consumption for drying wet cotton laundry.

# OPTIONS

## DRYNESS LEVEL

This function helps to increase dryness of the laundry. There are 3 options:

-  Extra Dry
-  Cupboard Dry
-  Iron Dry

## REVERSE PLUS

Increase drum reversing frequency to reduce items twisting and entanglement. To increase uniformity of drying result and help reduce creases. Recommended for large or long items (e.g. sheets, trousers, long dresses)"

## LONG ANTICREASE

Extends the anti-crease phase by 60 minutes at the end of the drying cycle. This function reduces creases. The laundry can be removed during the anti-crease phase.

## TIME DRY

You can set the programme duration, from a minimum of 10 minutes to a maximum of 2 hours. The required duration is related to the quantity of laundry in the appliance.



We recommend that you set a short duration for small quantities of laundry or for only one item.





## TIME DRYING RECOMMENDATION

10 - 20 min	action of cool air only (no heater).
20 - 40 min	additional drying to improve dryness after previous drying cycle.
>40 min	full drying of the small laundry loads up to 4 kg, well spun (>1200 rpm).

## TIME DRY ON WOOL PROGRAMME

Option suitable for Wool programme to adjust final dryness level.

## OPTIONS TABLE

Programmes <sup>1)</sup>	Dryness Level			Reverse Plus	Long Anti-crease	Time Dry
						
 Cottons <b>Eco</b>		▪			▪	
Cottons	▪	▪	▪	▪	▪	
Synthetics	▪	▪	▪	▪	▪	
Delicates		▪			▪	
Wool						▪ <sup>2)</sup>
Time Dry					▪	▪
Refresh					▪	
Easy Iron			▪		▪	
Sportwear		▪			▪	
Denim	▪	▪		▪	▪	

Programmes <sup>1)</sup>	Dryness Level	Reverse Plus	Long Anti-crease	Time Dry
Bed Linen	■		■	
Mix EasyDry	■		■	

1) Together with the programme you can set 1 or more options. To activate or deactivate them, press the related touch button.

2) See chapter OPTIONS: Time Drying on Wool programme

## SETTINGS

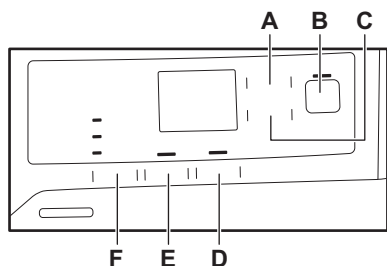

- A. Time Dry touch button
- B. Start/Pause touch button
- C. Delay Start touch button
- D. Long Anticrease touch button
- E. Reverse Plus touch button
- F. Dryness Level touch button

### CHILD LOCK FUNCTION

This option prevents children playing with the appliance while a programme is operating. The touch buttons are locked.

Only the on/off button is unlocked.

#### Activating the child lock option:

1. Press the on/off button to activate the appliance.
2. Press and hold touch button (D) for a few seconds.

The child lock indicator comes on.

- i** It is possible to deactivate the child lock option while a programme operates. Press and hold the same touch buttons until the child lock indicator goes off. The Child Lock function isn't available for 8 s after switching on the appliance.

### ADJUSTMENT OF REMAINING LAUNDRY MOISTURE

- i** Every time you enter in the "Adjustment of remaining laundry moisture" mode, previously set degree of remaining moisture will change into next value (e.g. previously set - 2 - will change into - 1 -).

To change the default degree of remaining moisture:

1. Press the on/off button to activate the appliance.
2. Use the programme knob to set any programme.
3. Wait approximately 8 seconds.
4. Press and hold buttons (F) and (E) at the same time.

One of these indicators comes on:

- - 0 - the maximum dryness
  - - 1 - the more dry laundry
  - - 2 - the standard dry laundry
5. Press and hold buttons (F) and (E) again until the indicator of the correct level comes on.

- i** If the display returns to the normal mode (the time of the selected programme from step 2. will be displayed), while setting the degree of remaining moisture, press and hold buttons (F) and (E) once again to enter to the "Adjustment of remaining laundry moisture" mode (previously set degree of remaining moisture will change into next value).

6. After 5 s the display returns to normal mode.

## WATER CONTAINER INDICATOR

By default, the water container indicator is on. It comes on when the programme is completed or when it is necessary to empty the water container.

- i** If a draining kit is installed (additional accessory), the appliance automatically drains the water from the water container. In this case we recommend that you deactivate the indicator of the water container.

### Deactivating the water container indicator:

1. Press the on/off button to activate the appliance.

## BEFORE FIRST USE

- i** Rear drum locks are removed automatically when dryer is activated for the first time. Possible to hear some noise.

- i** It is highly recommended to start any programme for the first time without the load for a few seconds to ensure that the rear drum locks are removed properly.

### To unlock the rear drum locks:

1. Switch on the appliance.
2. Set any programme.
3. Press the Start/Pause button.

Drum starts to rotate. Rear drum locks are automatically deactivated.

- i** If the drum still does not rotate, please release the rear drum locks manually (to do that, please use provided key).

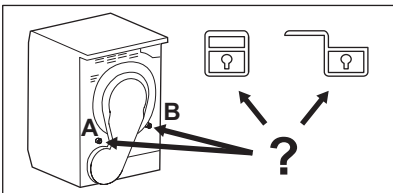

2. Wait approximately 8 seconds.
3. Press and hold touch buttons (E) and (D) at the same time.

The display shows one of these 2 configurations:

- The display shows "Off". After 5 s the display returns to normal mode.
- The display shows "On". After 5 s the display returns to normal mode.

## BUZZER ON/OFF

To deactivate or activate the acoustic signals, press and hold for approximately 2 seconds touch buttons (A) and (C) at the same time.

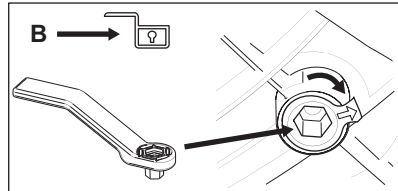
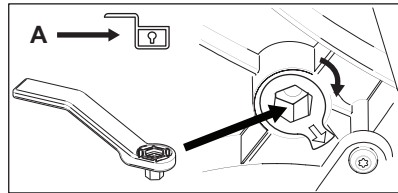

### Before you use the appliance to dry items:

- Clean the tumble dryer drum with a moist cloth.
- Start a 1 hour programme with moist laundry.

- i** At the beginning of the drying cycle (first 3-5 min) there could be a slightly higher sound level. This is due to the compressor starting up. This is normal for compressor powered appliances such as refrigerators and freezers.

## UNUSUAL SMELL

The appliance is tightly packed.

After product unpacking you can feel an unusual smell. This is normal for brand new products.

Appliance is built of several different types of material which all together can generate unusual smell.

Over usage time, after few drying cycles unusual smell gradually disappears.

## NOISES



Different noises may be heard at different times during the drying cycle. They are perfectly normal operating sounds.

### Working compressor.

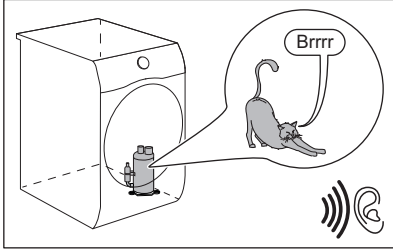

### Rotating drum.

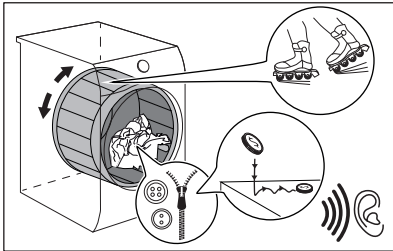

### Working fans.

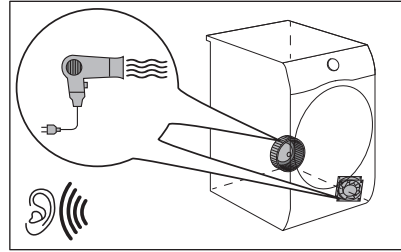

### Working pump and transferring condensation to the tank.

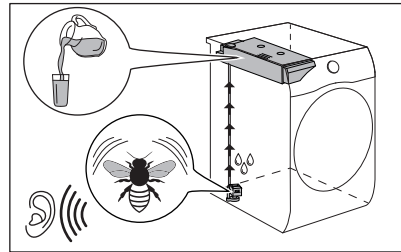

## DAILY USE

### START A PROGRAMME WITHOUT DELAY START

1. Prepare the laundry and load the appliance.

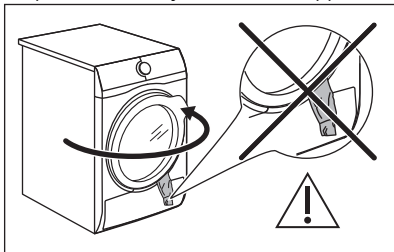

**CAUTION!** Make sure that when you close the door, the laundry does not get caught between the appliance door and the rubber seal.

2. Press the on/off button to activate the appliance.

3. Set the correct programme and options for the type of load.

The display shows the programme duration.



Real drying time will depend on type of the load (quantity and composition), the room temperature and the humidity of your laundry after spin drying phase.

4. Press the Start/Pause touch button.

The programme starts.

### STARTING THE PROGRAMME WITH DELAY START

1. Set the correct programme and options for the type of load.
2. Press the delay start button again and again until the display shows the delay time you want to set.



You can delay the start of a programme from a minimum of 1 hour to a maximum of 20 hours.

3. Press the Start/Pause touch button.

**The display shows the countdown of the delay start.**

When the countdown is completed, the programme starts.

**CHANGE A PROGRAMME**

1. Press the on/off button to deactivate appliance
2. Press the on/off button to activate the appliance.
3. Set the programme.

**Alternatively:**

1. Rotate the selector knob to the ● "Reset" position.
2. Wait for 1 second. The display shows — — —.
3. Set the programme.

**AT THE END OF THE PROGRAMME**

When the programme is completed:

- An intermittent acoustic signal operates.
- The display shows :
- The indicators Filter and Tank comes on.
- The Start/Pause indicator is on.

The appliance continues to operate with the anti-crease phase for approximately 30 minutes or more if Long Anticrease option was set (see chapter *Option - Long Anticrease* ).

The anti-crease phase reduces creasing.

You can remove the laundry before the anti-crease phase is completed. We recommend, for better

results, that you remove the laundry when the phase is almost completed or completed.

When the anti-crease phase is completed:

- The display still shows :
- The indicators Filter and Tank comes on.
- Start/Pause indicator goes off.

1. Press the on/off button to deactivate the appliance.
2. Open the appliance door.
3. Remove the laundry.
4. Close the appliance door.

Possible causes of unsatisfactory drying results:

- Inadequate default dryness level settings. See chapter *Adjustment of default dryness level*
- Room temperature is too low or too high. Optimal room temperature is between 18°-25°C.



**Always clean the filter and empty the water container when a programme is completed.**

**STAND-BY FUNCTION**

To reduce energy consumption, this function automatically deactivates the appliance:

- After 5 minutes if you do not start the programme.
- After 5 minutes from the end of the programme.



The time is reduced to 30 seconds if the selector knob is pointing to ● "Reset" position.

**HINTS AND TIPS**

**PREPARING THE LAUNDRY**



Very often the clothes after washing cycle are kneaded and tangled altogether.

Drying kneaded and tangled clothes is inefficient.

To assure proper air flow and even drying it is recommended to shake and load one by one the clothes to the tumble dryer.

To assure proper drying process:

- Close the zips.
- Close the fasteners of duvet covers.
- Do not dry ties or ribbons loose (e.g. apron ribbons). Tie them before you start a programme.
- Remove all items from pockets.

- Turn items with the internal layer made of cotton inside out. Cotton layer must be faced outwards.
- Always set the programme suitable for the type of laundry.
- Do not put light and dark colours together.
- Use suitable programme for cottons, jersey and knitwear to reduce shrinkage.
- Do not exceed the maximum load stated in the programmes chapter or shown on the display.
- Dry only the laundry that is suitable for tumble drying. Refer to the fabric label on the items.
- Do not dry large and small items together. Small items can be trapped inside the large items and remain wet.
- Shake the large clothes, fabrics before placing in the tumble dryer. It is to avoid moist places inside the fabric after the drying cycle.

Fabric label	Description
☐	Laundry is suitable for tumble drying.
☺	Laundry is suitable for tumble drying at higher temperatures.
☉	Laundry is suitable for tumble drying at low temperatures only.
☒	Laundry is not suitable for tumble drying.

## CARE AND CLEANING

### CLEANING THE FILTER



**CAUTION!** Avoid the use of water to clean the filter. Instead throw away lint in the dustbin ( avoid dispersion of plastic fiber in water ambient).



To achieve the best drying performances clean the filter regularly , clogged filter lead to longer cycles and energy consumption increase. Use your hand to clean the filter , and if necessary , a vacuum cleaner .

1.

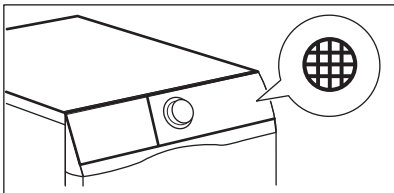

2.

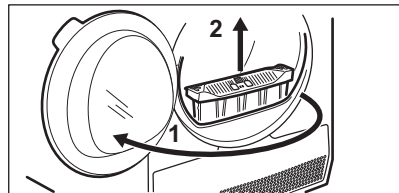

3.

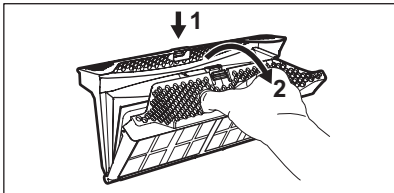

4.

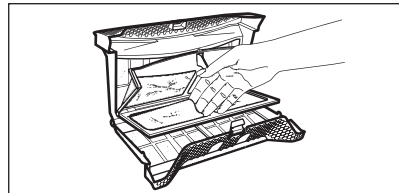

5. 1)

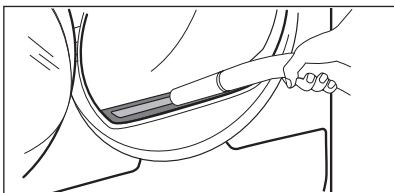

6.

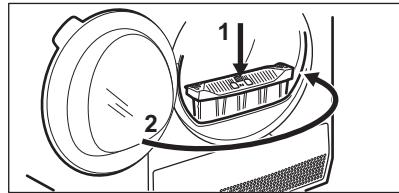

1) If necessary remove fluff from the filter socket and gasket. You can use a vacuum cleaner.

## EMPTYING THE WATER CONTAINER

1.

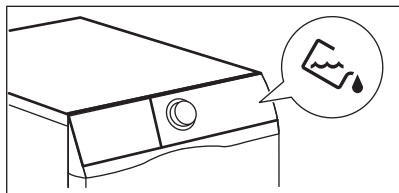

2.

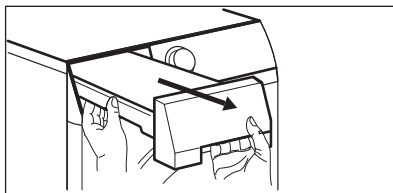

3.

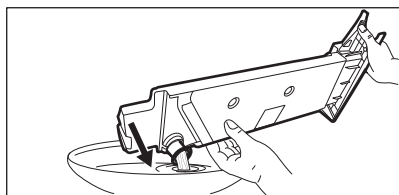

4.

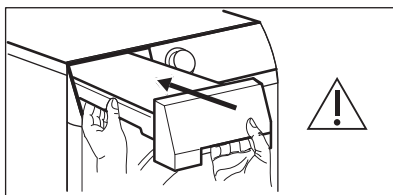

You can use the water from the water container as an alternative to distilled water (e.g. for steam ironing). Before you use the water, remove dirt residues with a filter.

## CLEANING THE HEAT EXCHANGER

1.

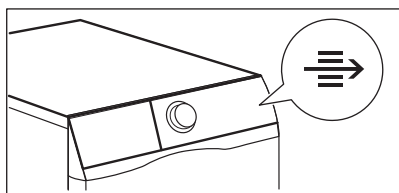

2.

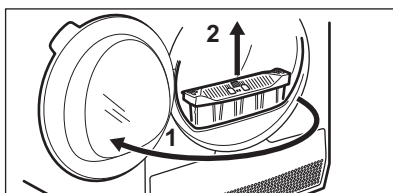

3.

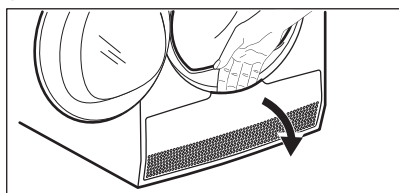

4.

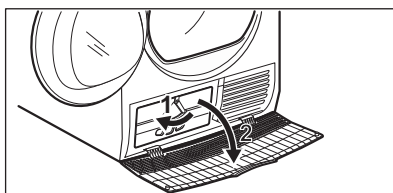

5.

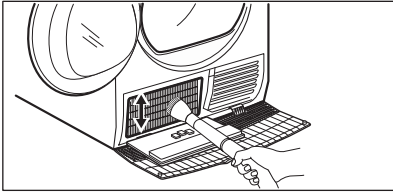

7.

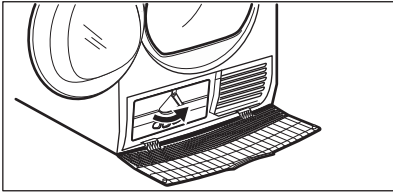

9.

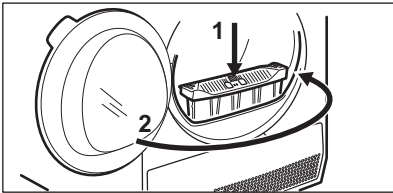

6.

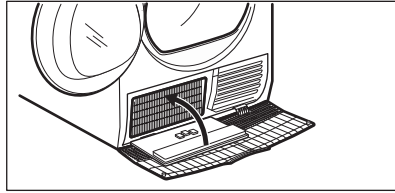

8.

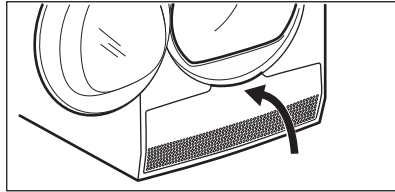

**CAUTION!** Do not touch the metal surface with bare hands. Risk of injury. Wear protective gloves. Clean carefully to avoid damaging the metal surface.

### CLEANING THE HUMIDITY SENSOR



**CAUTION!** Risk of humidity sensor damage. Do not use abrasive materials or steel wool to clean the sensor.

To assure best drying results the appliance is equipped with metal humidity sensor. It is placed on the inner side of the door area.

Over usage time the surface of the sensor may get dirty what deteriorates the drying performance.

We recommend to clean the sensor at least 3 or 4 times or if you observe the drop of drying performance.

To clean you can use harder side of dish-washing sponge and bit of vinegar or dish soap.

To clean the sensor:

1. Open the loading door.
2. Clean the surfaces of the humidity sensor wiping off the metal surface several times.

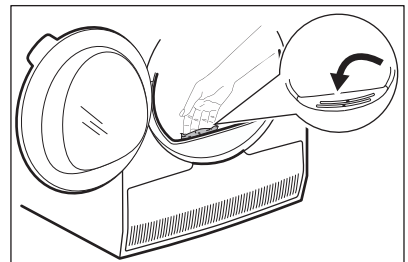

### CLEANING THE DRUM



**WARNING!** Disconnect the appliance before you clean it.

Use a standard neutral soap detergent to clean the inner surface of the drum and drum lifters. Dry the cleaned surfaces with a soft cloth.



**CAUTION!** Do not use abrasive materials or steel wool to clean the drum.

## CLEANING THE CONTROL PANEL AND HOUSING

Use a standard neutral soap detergent to clean the control panel and housing.

Use a moist cloth to clean. Dry the cleaned surfaces with a soft cloth.



**CAUTION!** Do not use furniture cleaning agents or cleaning agents which can cause corrosion.

## CLEANING THE AIRFLOW SLOTS

Use a vacuum cleaner to remove fluff from the airflow slots.

## TROUBLESHOOTING

---



**WARNING!** Refer to Safety chapters.

### ERROR CODES

The appliance does not start or it stops during operation.

First try to find a solution to the problem (refer to the table). If the problem persists, contact the Authorised Service Centre.



**WARNING!** Deactivate the appliance before carrying out any check.

**In case of major problems, the acoustic signals operate, the display shows an error code and the Start/Pause button may flash continuously:**

Error code	Possible cause	Remedy
<b>E5A</b>	Appliance motor overloaded. Too much laundry or entrap in the drum.	The programme was not completed. Remove the laundry from the drum, set the programme and restart the cycle.
<b>E97</b>	Internal fail. No communication between electronic elements of the appliance.	The programme was not finished properly or the appliance stopped too early. Switch the appliance off and on again. If the error code appears again, contact the Authorised Service Centre.
<b>EH0</b>	The mains supply is unstable.	When the appliance is showing <b>EH0</b> , please wait until main supply is stable than press start. If the appliance pause the cycle without any indication then press the cycle start. If the warning will occur check the power cord / socket integrity or main supply.

If the display shows other error codes, deactivate and activate the appliance. If the problem continues, contact the Authorised Service Centre.

In case of different problem with the tumble dryer check the table below for possible solutions.

## TROUBLESHOOTING

Problem	Possible solution
You cannot activate the appliance.	Make sure that the mains plug is connected to the mains socket.
	Check fuse in fuse box (domestic installation).
The drum does not rotate.	Release the rear drum locks manually (see chapter <i>Before First Use</i> ).
The programme does not start.	Press Start/Pause.
	Make sure that the appliance door is closed.
The appliance door does not close.	Make sure that the installation of the filter is correct.
	Make sure that the laundry is not caught between the appliance door and the rubber seal.
The appliance stops during operation.	Make sure that the water container is empty. Press Start/Pause to start the programme again.
	Load is too small, increase the load or use the Time Dry programme.
The cycle time is too long or unsatisfactory drying result. <sup>1)</sup>	Make sure that the weight of the laundry is suitable for the duration of the programme.
	Make sure that the filter is clean.
	The laundry is too wet. Spin the laundry in the washing machine again.
	Ensure that the room temperature is higher than +5°C and lower than +35°C. Optimal room temperature is 18°C to 25°C.
	Set the Time Dry or the Extra Dry programme. <sup>2)</sup>
The display shows — — —.	If you want to set a new programme, deactivate and activate the appliance.
	Make sure that the options are suitable for the programme.

1) After maximum 5 hours, the programme ends automatically.

2) It can happen that some area remains humid when drying big items (e.g. bed sheets).

### If the drying results are not satisfactory

- The set programme was incorrect.
- The filter is clogged.
- The Heat Exchanger is clogged.
- There was too much laundry in the appliance.
- The drum is dirty.
- Incorrect setting of the conductivity sensor ( See chapter "*Settings - Adjustment of the*

*remaining laundry moisture degree* " for better setting).

- The airflow slots are clogged.
- Room temperature is too low or too high ( optimal room temperature 18°C to 25°C )

## TECHNICAL DATA

Height x Width x Depth	850 x 596 x 638 mm (maximal 662 mm)
Max. depth with the appliance door open	1107 mm
Max. width with the appliance door open	958 mm
Adjustable height	850 mm (+ 15 mm - feet regulation)
Drum volume	118 l
Maximum load volume	<b>8 kg</b>
Voltage	230-240 V
Frequency	50 Hz
Sound power level	66 dB
Necessary fuse	13 A
Total power	800 W
Energy efficiency class	<b>A++</b>
Energy consumption on the standard cotton programme with the full load. <sup>1)</sup>	<b>1,93 kWh</b>
Energy consumption on the standard cotton programme with the partial load. <sup>2)</sup>	<b>1,08 kWh</b>
Annual energy consumption <sup>3)</sup>	234,7 kWh
Left-on mode power absorption <sup>4)</sup>	0,50 W
Off mode power absorption <sup>4)</sup>	0,50 W
Type of use	Household
Allowed ambient temperature	+ 5°C to + 35°C
Level of protection against ingress of solid particles and moisture ensured by the protective cover, except where the low voltage equipment has no protection against moisture	<b>IPX4</b>
Gas designation	R290
Weight	0,140 kg

**1)** With reference to BS EN 61121. 8 kg of cotton centrifuged at 1000 rpm.

**2)** With reference to BS EN 61121. 4 kg of cotton centrifuged at 1000 rpm.

**3)** Energy consumption per year in kWh, based on 160 drying cycles of the standard cotton programme at full and partial load, and the consumption of the low-power modes. Actual energy consumption per cycle will depend on how the appliance is used (according to UK Ecodesign and Energy Labelling Regulations).

**4)** With reference to BS EN 61121.

The information given in the chart above is compliant with the UK Ecodesign and Energy Labelling Regulations.

## CONSUMPTION DATA

Programme	Spun at / residual humidity	Drying time <sup>1)</sup>	Energy consumption <sup>2)</sup>
Cottons <b>Eco</b> 8 kg			
Cupboard Dry	1400 rpm / 50%	145 min.	1,59 kWh
	1000 rpm / 60%	178 min.	1,93 kWh
Cottons 8 kg			
Iron Dry	1400 rpm / 50%	110 min.	1,18 kWh
	1000 rpm / 60%	140 min.	1,45 kWh
Cottons <b>Eco</b> 4 kg			
Cupboard Dry	1400 rpm / 50%	89 min.	0,90 kWh
	1000 rpm / 60%	104 min.	1,08 kWh
Synthetics 3,5 kg			
Cupboard Dry	1200 rpm / 40%	62 min.	0,59 kWh
	800 rpm / 50%	81 min.	0,79 kWh

1) For partial loads, the cycle time is shorter and appliance uses less energy.

2) Improper ambient temperature and/or poorly centrifuged laundry can prolong cycle time and increase the energy consumption.

## QUICK GUIDE

### DAILY USE

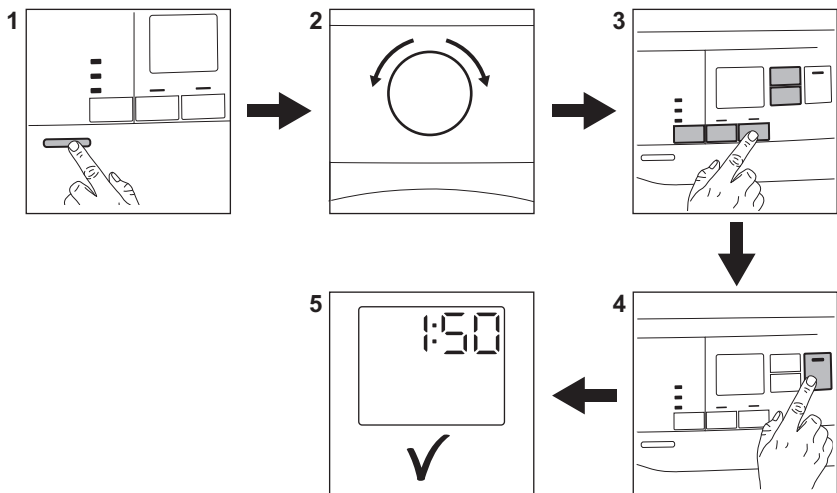





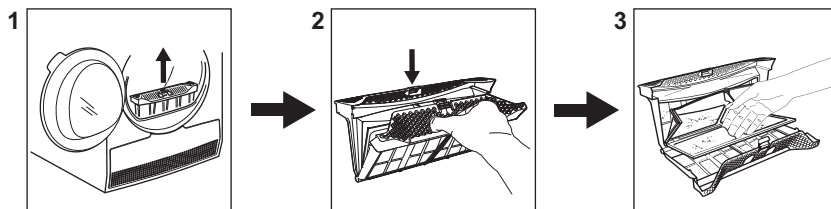









1. Push the On/Off button to turn on the appliance.
2. Use the programme dial to set the programme.
3. Together with the programme you can set 1 or more special options. To activate or deactivate an option touch the relevant button.
4. To start the programme, Touch the **Start/ Pause** button.
5. The appliance starts.





## CLEANING THE FILTER



At the end of each cycle the filter symbol  appears on the display and you must clean the filter.

## PROGRAMME TABLE

Programme	Load <sup>1)</sup>	Properties / Fabric type <sup>2)</sup>	
 <sup>3)</sup> Cottons <b>Eco</b>	<b>8 kg</b>	Cycle to be used to dry cotton with "cotton cupboard" dryness level, with maximum energy saving.	/  
Cottons	<b>8 kg</b>	Cycle defined to dry cottons items of different size / different weaving altogether.	/  
Synthetics	<b>3,5 kg</b>	Synthetic and mixed fabrics.	/   
Delicates	<b>4 kg</b>	Delicate fabrics such as viscose, rayon, acrylic, and their blends.	/   
Wool	<b>1 kg</b>	Woollen fabrics. Gentle drying of washable woollens. Remove items immediately when the programme is completed.	
Time Dry	<b>5 kg</b>	With this programme you can use the Time Dry option and set the programme duration. Drying time should be adequate to the load, e.g. 2h for 5 kg of cotton.	/   
Refresh	<b>1kg</b>	Refreshing textiles that were in storage.	

Programme	Load <sup>1)</sup>	Properties / Fabric type <sup>2)</sup>	
Easy Iron	<b>1 kg (or 5 shirts)</b>	Easy care fabrics for which a minimum of ironing is necessary. The drying results can be different from one type of fabric to another. Shake the items before putting them in the appliance. When the programme has ended, immediately remove the items and put them on a hanger.	/ 
Sportswear	<b>2 kg</b>	Sportswear, thin and light fabrics, microfiber, polyester.	/ 
Denim	<b>4 kg</b>	Leisure clothing such as jeans, sweat-shirts of different material thicknesses (e.g. at the neck, cuffs and seams).	/ 
Bed Linen	<b>3kg</b>	Bed linen such as single and double sheets, pillowcases, duvet cover.	/ 
Mix EasyDry	<b>3kg</b>	Cotton and synthetic fabrics. Low temperature programme. Delicate programme with warm air.	/ 

1) The maximum weight refers to dry items.

2) For fabric mark meaning see chapter *HINTS AND TIPS: Preparing the laundry*.

3) The  Cottons Cupboard Dry ECO programme is the "Standard cotton programme" according to UK Ecodesign and Energy Labelling Regulations. It is suitable for drying normal wet cotton laundry and it is the most efficient programme in terms of energy consumption for drying wet cotton laundry.

## PRODUCT INFORMATION SHEET ACCORDING TO UK ECODESIGN AND ENERGY LABELLING REGULATIONS

Product Information Sheet	
Trade Mark	ZANUSSI
Model	ZDH87A2PW PNC916098959
Rated capacity in kg	8
Air vented or condenser tumble dryer	Condenser
Energy efficiency class	A++
Energy consumption in kWh per year, based on 160 drying cycles of the standard cotton programme at full and partial load, and the consumption of the low-power modes. Actual energy consumption per cycle will depend on how the appliance is used.	234,7
Automatic tumble drier or non-automatic tumble drier	Automatic
Energy consumption of the standard cotton programme at full load in kWh	1,93

Energy consumption of the standard cotton programme at partial load in kWh	1,08
Power consumption of the off-mode in W	0,50
Power consumption in left-on mode in W	0,50
Duration of the left on mode in minutes	10
The 'standard cotton programme' used at full and partial load is the standard drying programme to which the information in the label and the fiche relates, this programme is suitable for drying normal wet cotton laundry and it is the most efficient programme in terms of energy consumption for cotton.	
Weighted programme time of the 'standard cotton programme at full and partial load' in minutes	136
Programme time of the 'standard cotton programme at full load' in minutes	178
Programme time of the 'standard cotton programme at partial load' in minutes	104
Condensation efficiency class on a scale from G (least efficient) to A (most efficient)	B
Average condensation efficiency of the standard cotton programme at full load as a percentage	81
Average condensation efficiency of the standard cotton programme at partial load as a percentage	81
Weighted condensation efficiency for the 'standard cotton programme at full and partial load'	81
Sound power level in dB	66
Built in appliance Y/N	No

The information given in the chart above is compliant with the UK Ecodesign and Energy Labelling Regulations.

## ENVIRONMENTAL CONCERNS

Recycle materials with the symbol . Put the packaging in relevant containers to recycle it. Help protect the environment and human health by recycling waste of electrical and electronic appliances. Do not dispose of appliances marked

with the symbol  with the household waste. Return the product to your local recycling facility or contact your municipal office.







[WWW.ZANUSSI.COM/SHOP](http://WWW.ZANUSSI.COM/SHOP)



UK  
CA

136981951-A-302021