



Monodraught are the recognised market leaders in ultra-low carbon, low energy solutions for Natural Ventilation, Natural Cooling and Natural Lighting.

WINDCATCHER®, **SUNPIPE®** and **COOL-PHASE®** brands are synonymous with quality and innovation (ISO9001 & 14001) and are supported by our market leading design service.

Air-Precision is an addition to Monodraught's portfolio including grilles, diffusers, external louvres and volume control dampers.

PRODUCT RANGE OF GRILLES, DIFFUSERS, LOUVRES AND DAMPERS

We are supporting this range with:

- £1 million of fast moving stock
- Bespoke manufacture with any standard RAL colour within 5 days
- 15 dedicated selection experts
- Designed with industry leading software
- Belimo actuators used throughout
- AA5 anodisation (ISO7599) utilised
- Market leading quality fully supported by a **10 year guarantee**

We are confident that we can beat any quotation you have by 10% so please contact us on **01494897700** or email us on air-precision@monodraught.com

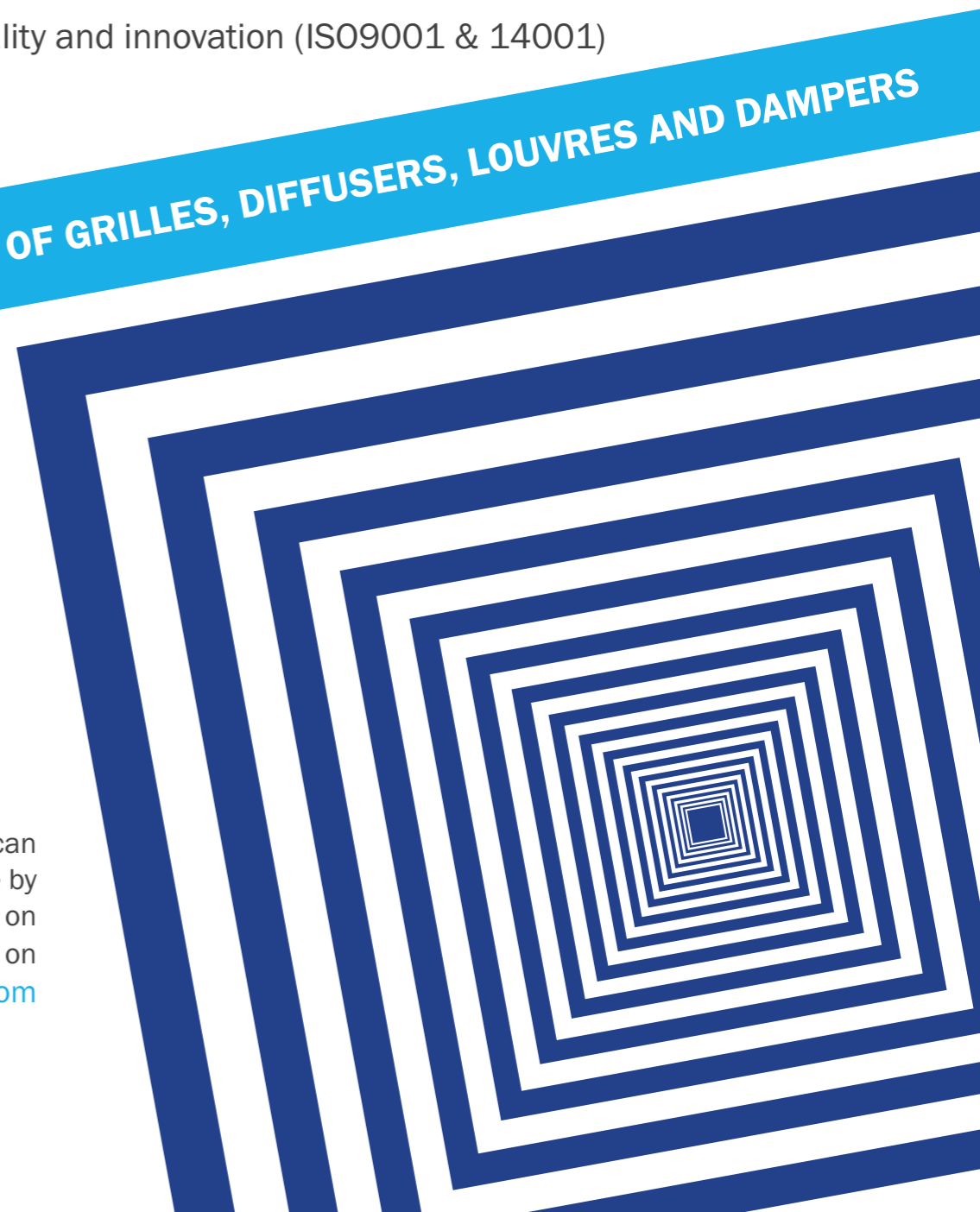

Non Vision Grilles - NV



Block line of sight into private areas: Giving adequate ventilation in areas where privacy must be maintained can be a challenge. NV1-3 non vision grilles have a special chevron blade arrangement, completely blocking line sight through the grilles.

Sight Blocking: The special chevron blade shape used on NV1, NV2 and NV3 grilles allows blades to interlock, completely blocking line of sight from any angle. NV4 grilles utilise a different, non chevron blade needed for the slimline construction. As a result, a very narrow line of sight can be obtained by looking up at the grille from directly below.

Aesthetics: Form, however, is just as important as function, and NV grilles have been designed to look as good as possible. NV1-3 grilles use the same style frames as the wider range of Air-Precision grilles for continuity across a range of grille types.

Materials:

- Extruded aluminium throughout

Construction:

- Frame held together using punched steel corners

Free Area:

- NV1 - NV3: Approx 38%
- NV4: Approx 30%

Mass/m² face area:

- NV1: 12.5 kg
- NV2: 15 kg
- NV3: 23 kg
- NV4: 11 kg

Options

Size:

- Minimum: 100 mm x 100 mm
- Maximum: 2900 mm x 2900 mm

Series:

- NV1: Standard flanged non-vision grille
- NV2: As NV1 but with spare backing frame for fitting into doors. Please state if deeper frame is required for doors up to 78 mm thick.
- NV3: Double layered grille for dark-rooms
- NV4: Slimline surface with a non chevron blade. Designed to suit fire doors. Please note: A very narrow sight line can be gained through NV4 grilles if looked at from directly below.

Series:

- NV1

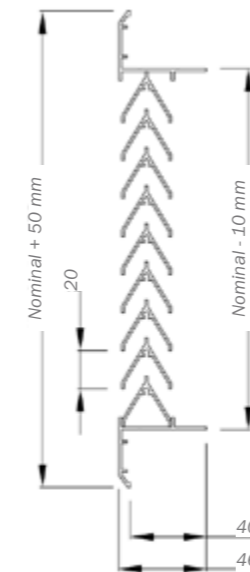

- NV2

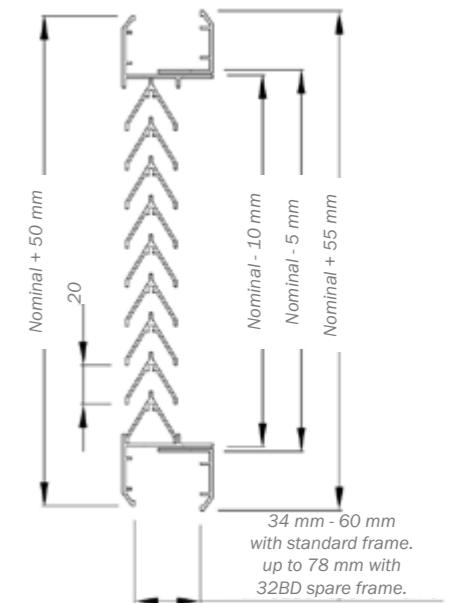

- NV3

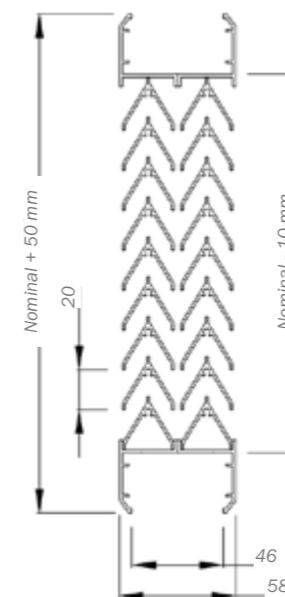

- NV4

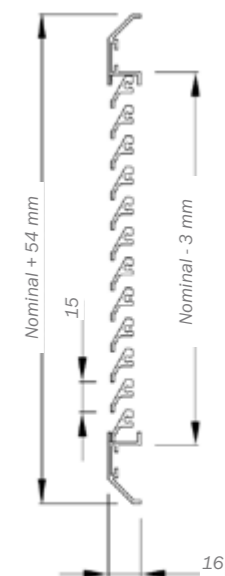

Non Vision Grilles - NV

Nominal Sizes Available

| H | WIDTH | | | | | | | | | | | | | | | | | | | |
|------|-------|-----|-----|-----|-----|-----|-----|-----|-----|-----|-----|-----|-----|-----|-----|-----|-----|-----|------|--|
| | 100 | 150 | 200 | 250 | 300 | 350 | 400 | 450 | 500 | 550 | 600 | 650 | 700 | 750 | 800 | 850 | 900 | 950 | 1000 | |
| 100 | | | | | | | | | | | | | | | | | | | | |
| 150 | | | | | | | | | | | | | | | | | | | | |
| 200 | | | | | | | | | | | | | | | | | | | | |
| 250 | | | | | | | | | | | | | | | | | | | | |
| 300 | | | | | | | | | | | | | | | | | | | | |
| 350 | | | | | | | | | | | | | | | | | | | | |
| 400 | | | | | | | | | | | | | | | | | | | | |
| 450 | | | | | | | | | | | | | | | | | | | | |
| 500 | | | | | | | | | | | | | | | | | | | | |
| 550 | | | | | | | | | | | | | | | | | | | | |
| 600 | | | | | | | | | | | | | | | | | | | | |
| 650 | | | | | | | | | | | | | | | | | | | | |
| 700 | | | | | | | | | | | | | | | | | | | | |
| 750 | | | | | | | | | | | | | | | | | | | | |
| 800 | | | | | | | | | | | | | | | | | | | | |
| 850 | | | | | | | | | | | | | | | | | | | | |
| 900 | | | | | | | | | | | | | | | | | | | | |
| 950 | | | | | | | | | | | | | | | | | | | | |
| 1000 | | | | | | | | | | | | | | | | | | | | |

Fixings:

FH Countersunk fixing holes:

For extremely simple fitting, countersunk fixing holes can be punched into the outer frame.

Self tapping screws in the same finish as the grilles are provided as standard.

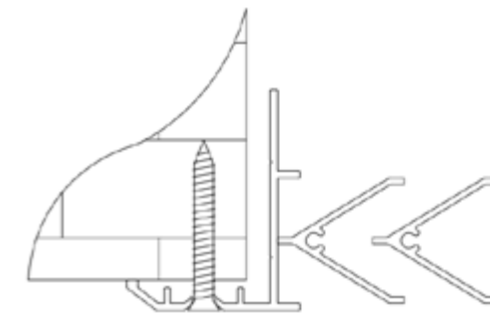

PC Push-in-clips:

These sprung clips are compressed when the grille is pushed into place. The outward force provided then holds the grille securely in place.

This fixing method is not suitable for use in ceilings.

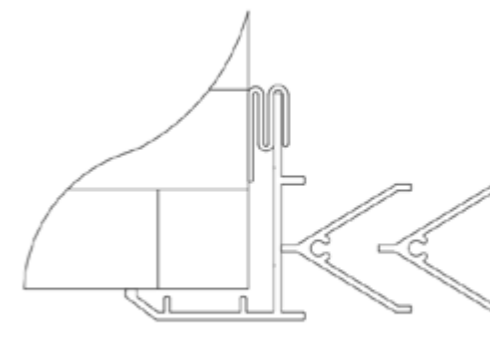

Non Vision Grilles - NV

Core Type:

- **Fixed**
- **RC Removable Core:**
Enabling the core to be removed entirely from the frame allows maximum entry space into ductwork behind. Held within its own frame, the core comes out in one whole unit for maximum ease. Colour matched bolts are fitted as standard.



- **HC Hinged Core:**
Held within its own frame as with the removable option, a silver piano hinge is fitted to one side of the internal frame. Able to swing out to 180°, access through hinged grilles is comparable to their fully removable cousins. Cam fasteners are fitted as standard, bolts will be fitted upon specification.



Frame Type:

- **NV1-3: 37 mm bevelled**

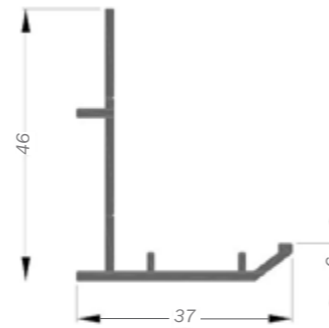

- **NV4: Slimline surface mounted**

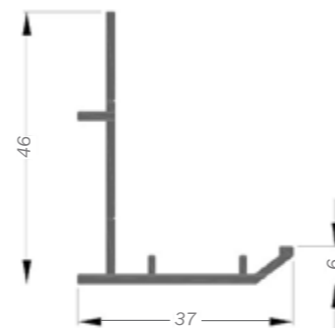

Finish:

- SAA: Satin anodised frame, mill finish core (standard)
- RAL: Polyester powder coated to RAL
- BS: Polyester powder coated to BS





Non Vision Grilles - NV

Selection data

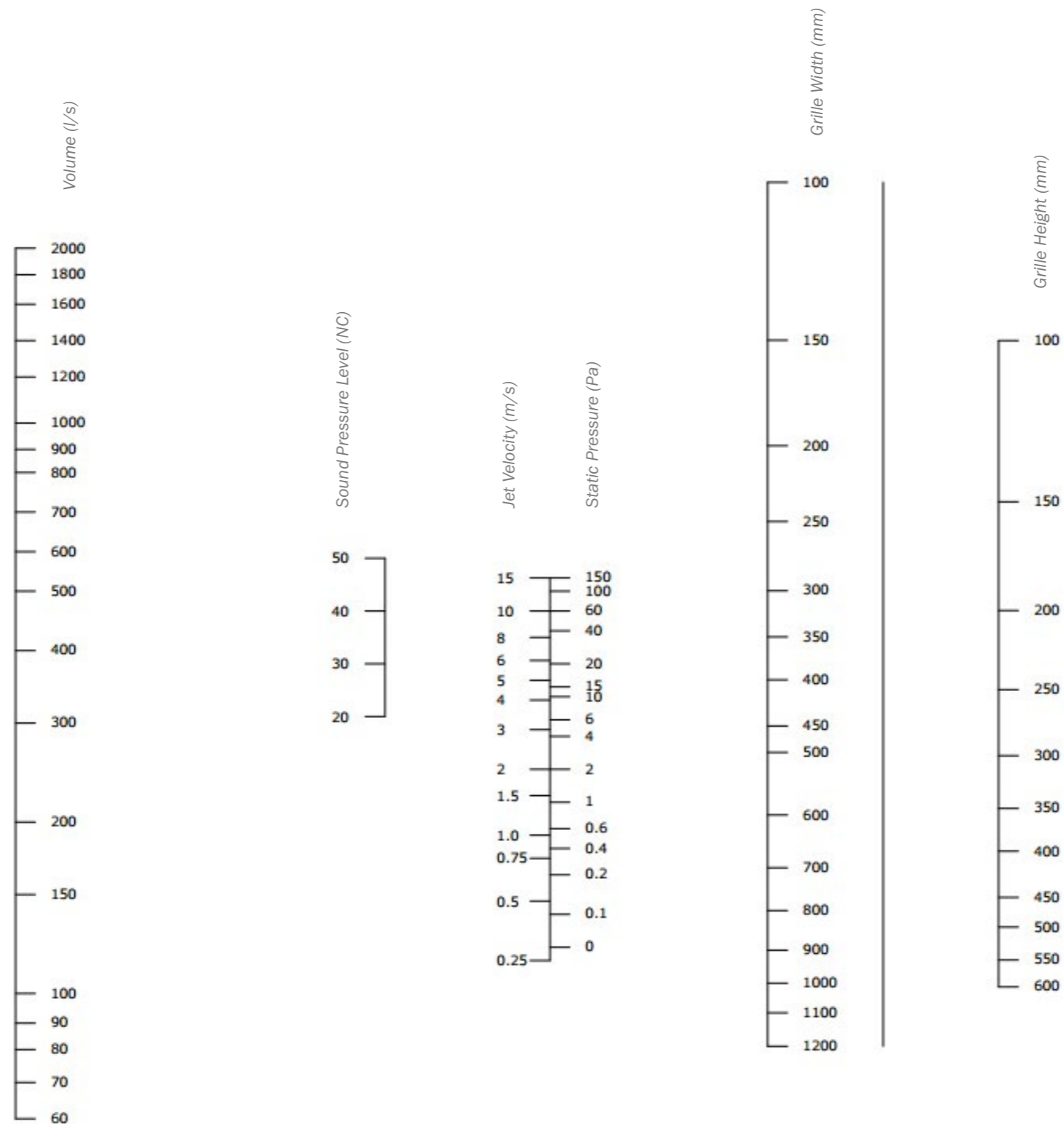
NV1 and NV2 Only



 Halifax House, High Wycombe
Buckinghamshire, HP12 3SE

 +44 01494 897700

 +44 01494 532465

 www.monodraught.com

 info@monodraught.com

 Monodraught Ltd

 @MonodraughtLtd

 Monodraught Ltd

 **Monodraught**[®]
engineering delivered. naturally

