



Monodraught are the recognised market leaders in ultra-low carbon, low energy solutions for Natural Ventilation, Natural Cooling and Natural Lighting.

WINDCATCHER[®], **SUNPIPE**[®] and **COOL-PHASE**[®] brands are synonymous with quality and innovation (ISO9001 & 14001) and are supported by our market leading design service.

Air-Precision is an addition to Monodraught's portfolio including grilles, diffusers, external louvres and volume control dampers.

PRODUCT RANGE OF GRILLES, DIFFUSERS, LOUVRES AND DAMPERS

We are supporting this range with:

- £1 million of fast moving stock
- Bespoke manufacture with any standard RAL colour within 5 days
- 15 dedicated selection experts
- Designed with industry leading software
- Belimo actuators used throughout
- AA5 anodisation (ISO7599) utilised
- Market leading quality fully supported by a **10 year guarantee**

We are confident that we can beat any quotation you have by 10% so please contact us on **01494897700** or email us on air-precision@monodraught.com

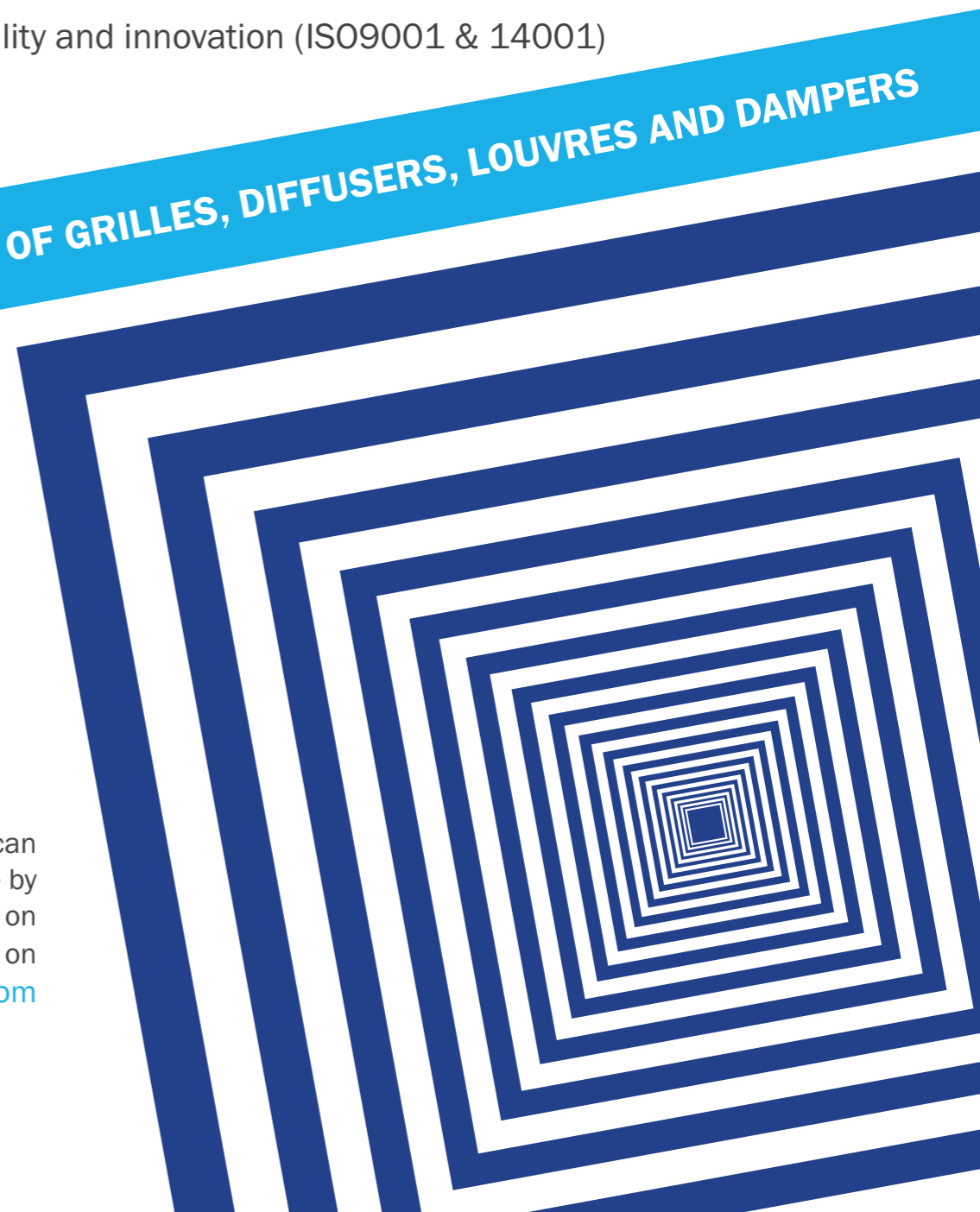

Perforated Plate Grilles - PPG



Perforated plate grilles are designed to integrate with the wider range Monodraught grilles by being offered with 30 mm flat or 37 mm bevelled flanges.

Just like laminar flow panels, they provide a stable throw of air, creating a clean area when used for supply.

Tamper resistant: The absence of any blades and the 3 mm hole diameter guards against any tampering with the grille. Perfect for areas where children are present.

Throw: As standard Series PPG grilles provide a long linear throw, such as that used in clean rooms. However, optional deflector plates set out of site behind the perforated plate, enable 1 way, 2 way opposite and corner, 3 way and 4 way blows to be created.

Material:

- Perforated steel plate.
- 3 mm holes, staggered 5 mm pitch, 0.7 mm thickness.
- Extruded aluminium frame.

Construction:

- Shaped perforated plate.
- Frame held together using punched in steel corners.

Sizes:

- Minimum size single unit 100 mm x 50 mm
- Maximum size single unit 2400 mm x 1200 mm

Free area:

- 46%.

Mass/M sq face area:

- 16.5 kg.

Mass/M sq face are inc OBD:

- 24.5 kg

Frame Type:

- Standard:

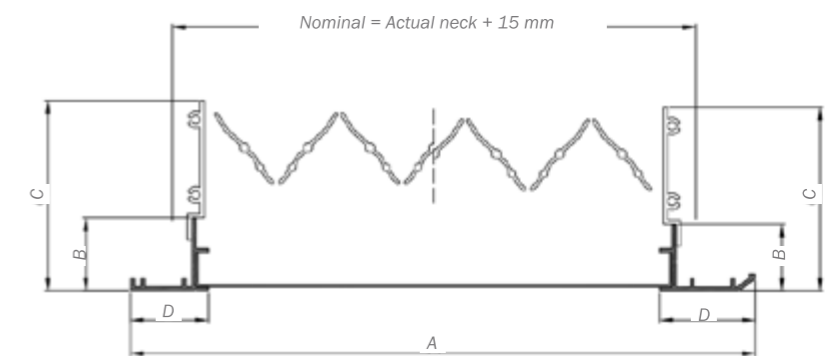

30 mm Flat Flange (optional)	
A	Nominal + 30 mm
B	28 mm
C	72 mm
D	30 mm

37 mm Bevelled Flange (standard)	
A	Nominal + 45 mm
B	25 mm
C	70 mm
D	37 mm

Perforated Plate Grilles - PPG

Core Type:

- **Fixed**
- **Removable Core:**
Enabling the core to be removed entirely from the frame allows maximum entry space into ductwork behind.
Held within its own frame, the core comes out in one whole unit for maximum ease.
Colour match bolts are fitted as standard.

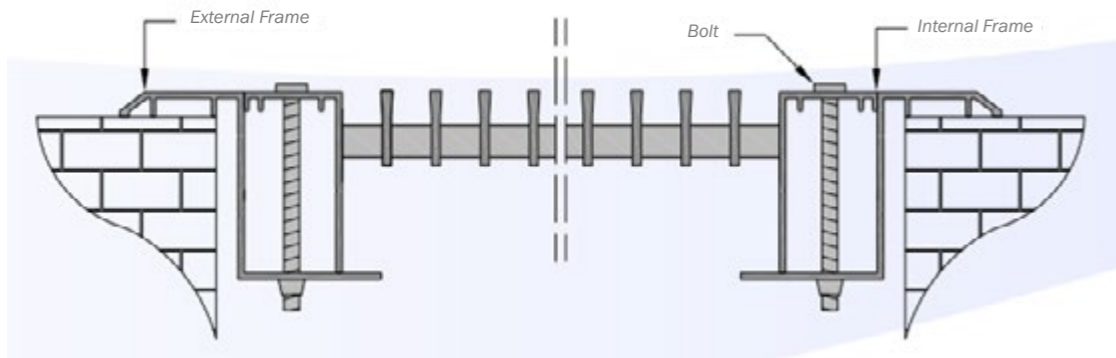

- **Hinged Core:**
Held within its own frame as with the removable option, a silver piano hinge is fitted to one side of the internal frame.
Able to swing out to 180°, access through hinged grilles is comparable to their fully removable cousins.
Cam fasteners are fitted as standard, bolts will be fitted upon specification.

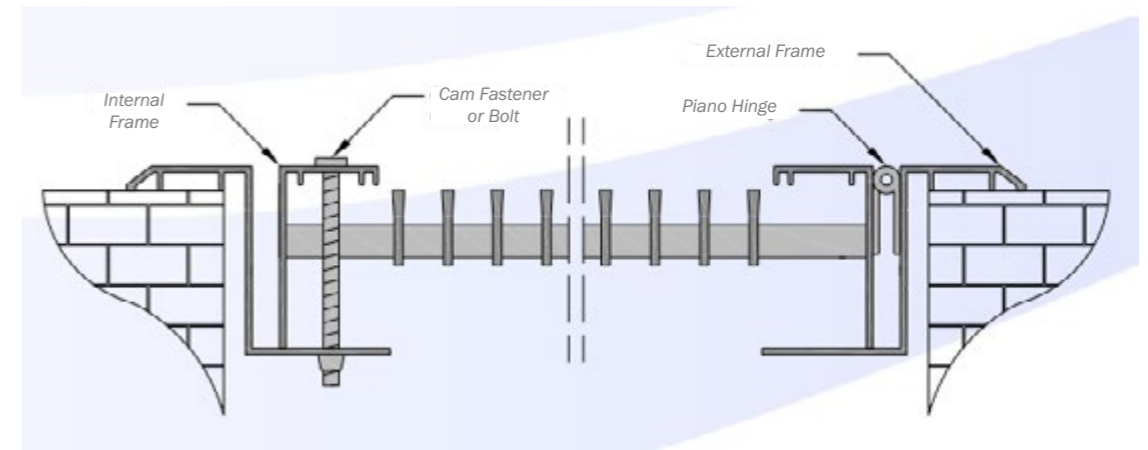

Fixings:

FH Countersunk fixing holes:

Countersunk fixing holes in the grille frame are the easiest fitting method. Screws in the same finish are supplied with the grille.

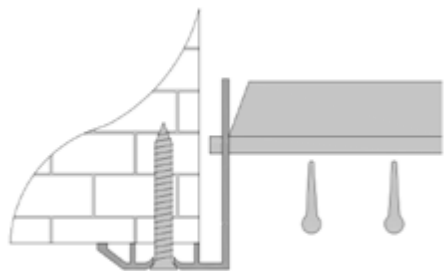

CF Concealed fixings:

Consisting of L brackets with threaded ports, one L bracket is fixed into the ductwork or plenum, the other is riveted to the rear of the grille frame. Supplied bolts are then used to hold the grille into the supporting structure.

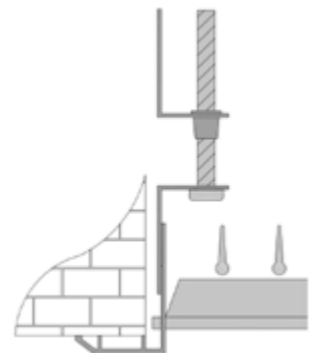

PC Push-in-clips:

These sprung clips are compressed when the grille is pushed into place. The outward force provided then holds the grille securely in place.

This fixing method is not suitable for use in ceilings.

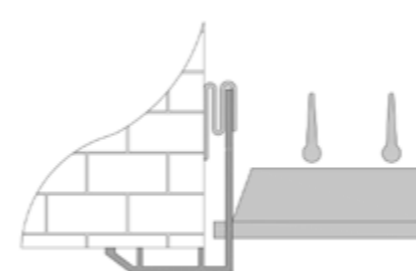

GB Goalpost brackets:

Enables the grille's removal by accessing bolts through the face.

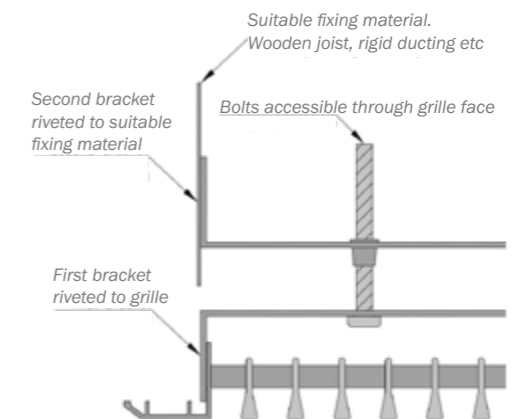

Perforated Plate Grilles - PPG

Selection data

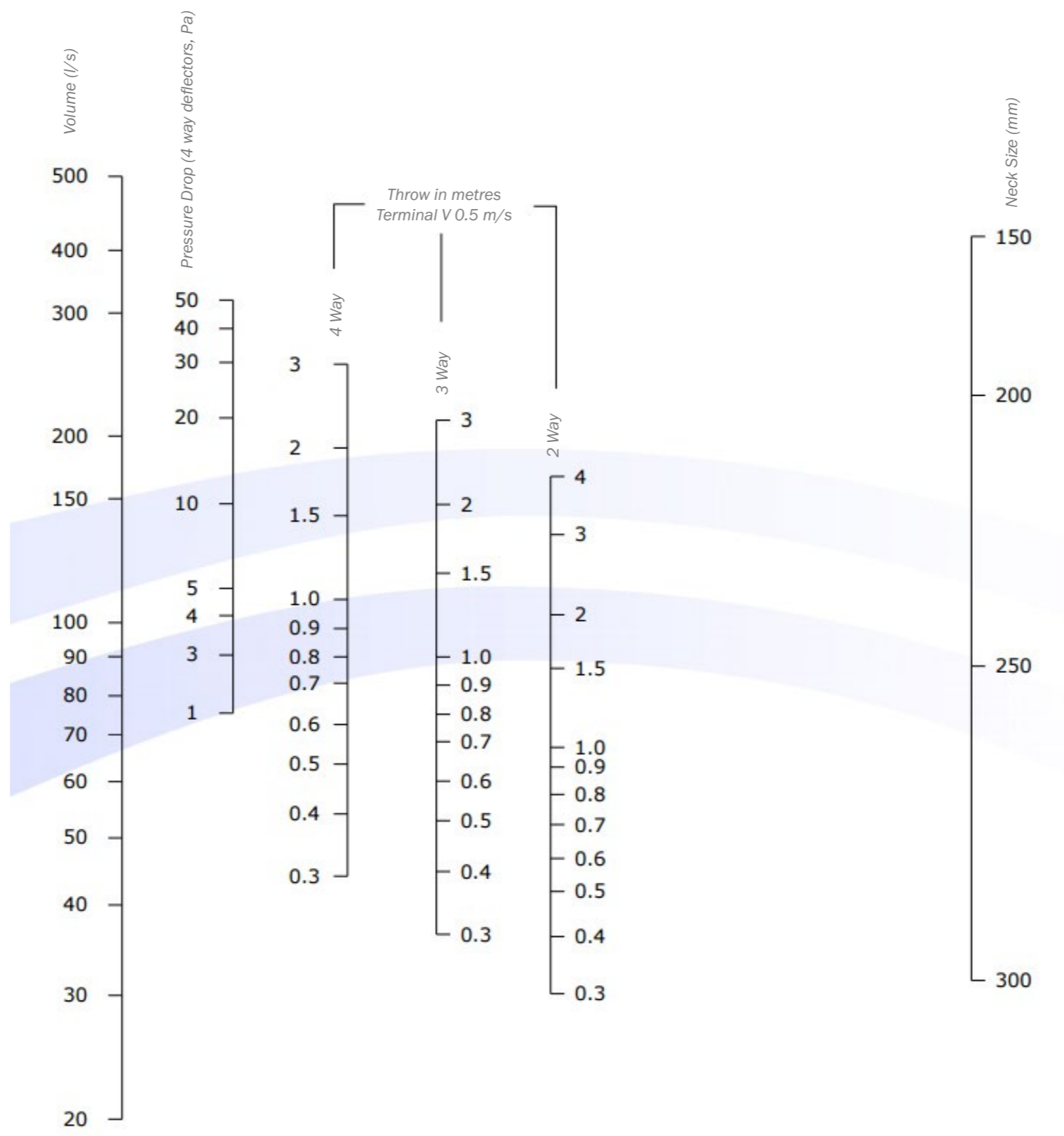

Grilles Options

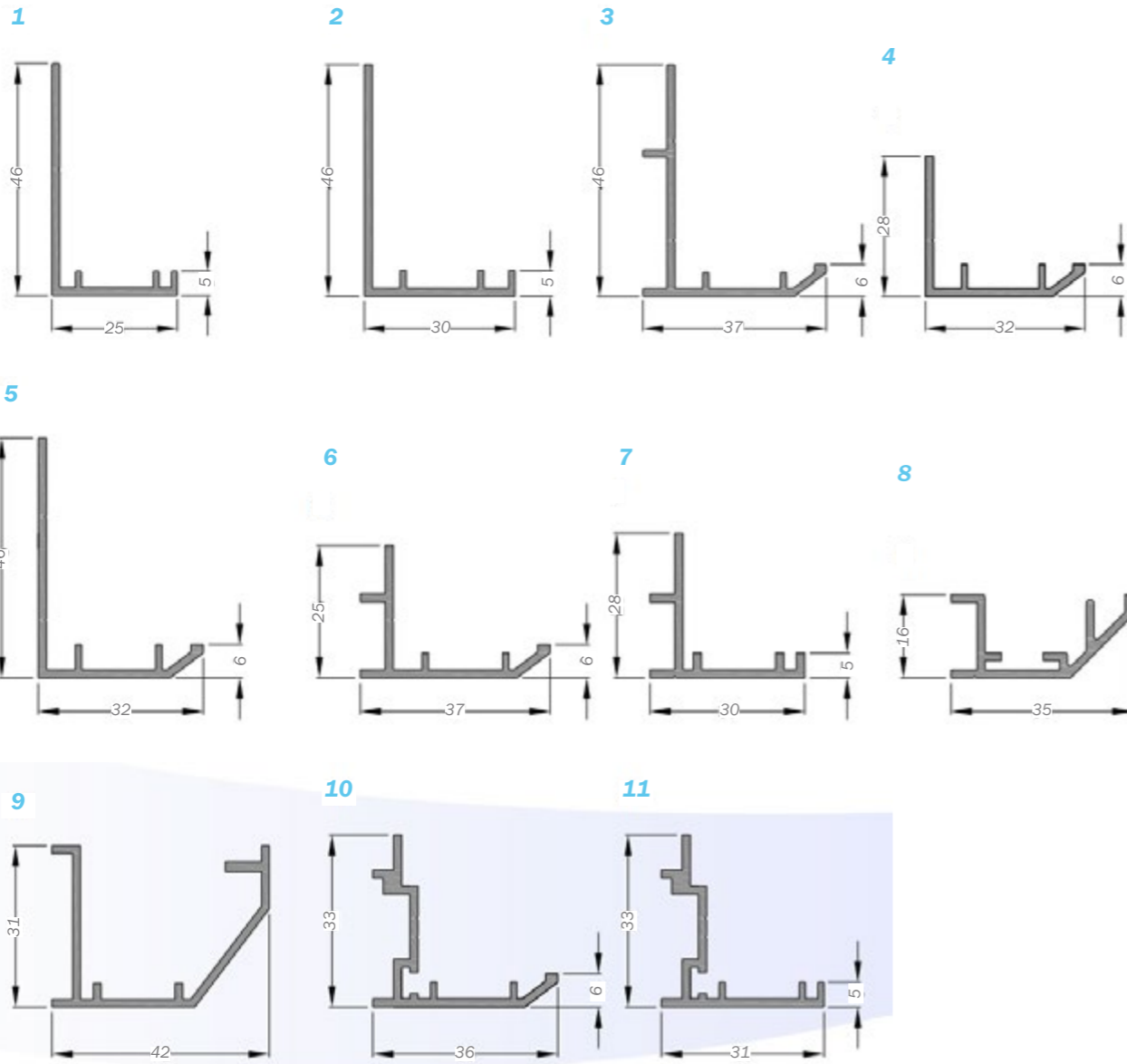



		Frame Types										
		1	2	3	4	5	6	7	8	9	10	11
Grille Series	FB	✓	1 Way	✓	STD	✓	✗	✗	✗	✓	✗	✗
	ECG	✗	✗	✓	✗	✗	STD	✓	✓	✓	✗	✗
	NV	✗	✗	NV1-3	✗	✗	✗	✗	NV4	✓	✗	✗
	CB	✓	✓	✓	STD	✓	✗	✗	✗	✓	✗	✗
	LG	✓	✓	✓	✓	✓	✗	✗	✗	✓	STD	✓
	LGFR	✓	✓	✓	✗	STD	✗	✗	✗	✗	✗	✗
	CFLG	N/A										
	SDG	N/A										
	PSG	N/A										
	LFP	✗	✗	✓	✗	✗	✓	✓	✗	✗	✗	✗
PPG	✗	✗	✓	✗	✗	STD	✓	✓	✓	✗	✗	✗

- 1. 25 mm Large Flat
- 2. 30 mm Flat
- 3. NV Angle
- 4. 32 mm Small Bevelled
- 5. 32 mm Large Bevelled
- 6. 37 mm ECG
- 7. 30 mm ECG
- 8. Slimline Surface Mounted
- 9. Large Surface Mounted
- 10. 36 mm Bevelled LG
- 11. 31 mm Flat LG

		Grille Series										
Core type		FB	ECG	NV	CB	LG	LGFR	CFLG	RGS	PSG	LFP	PPG
Hinged Core		✓	✓	✓	✓	✓	✗	N/A	N/A	N/A	✓	✓
Removable Core		✓	✓	✓	✓	✓	✗				✓	✓

 Halifax House, High Wycombe
Buckinghamshire, HP12 3SE

 +44 01494 897700

 +44 01494 532465

 www.monodraught.com

 info@monodraught.com

 Monodraught Ltd

 @MonodraughtLtd

 Monodraught Ltd

 **Monodraught**[®]
engineering delivered. naturally

