



**Monodraught** are the recognised market leaders in ultra-low carbon, low energy solutions for Natural Ventilation, Natural Cooling and Natural Lighting.

**WINDCATCHER**<sup>®</sup>, **SUNPIPE**<sup>®</sup> and **COOL-PHASE**<sup>®</sup> brands are synonymous with quality and innovation (ISO9001 & 14001) and are supported by our market leading design service.

**Air-Precision** is an addition to Monodraught's portfolio including grilles, diffusers, external louvres and volume control dampers.

**PRODUCT RANGE OF GRILLES, DIFFUSERS, LOUVRES AND DAMPERS**

#### We are supporting this range with:

- £1 million of fast moving stock
- Bespoke manufacture with any standard RAL colour within 5 days
- 15 dedicated selection experts
- Designed with industry leading software
- Belimo actuators used throughout
- AA5 anodisation (ISO7599) utilised
- Market leading quality fully supported by a **10 year guarantee**

We are confident that we can beat any quotation you have by 10% so please contact us on **01494897700** or email us on [air-precision@monodraught.com](mailto:air-precision@monodraught.com)

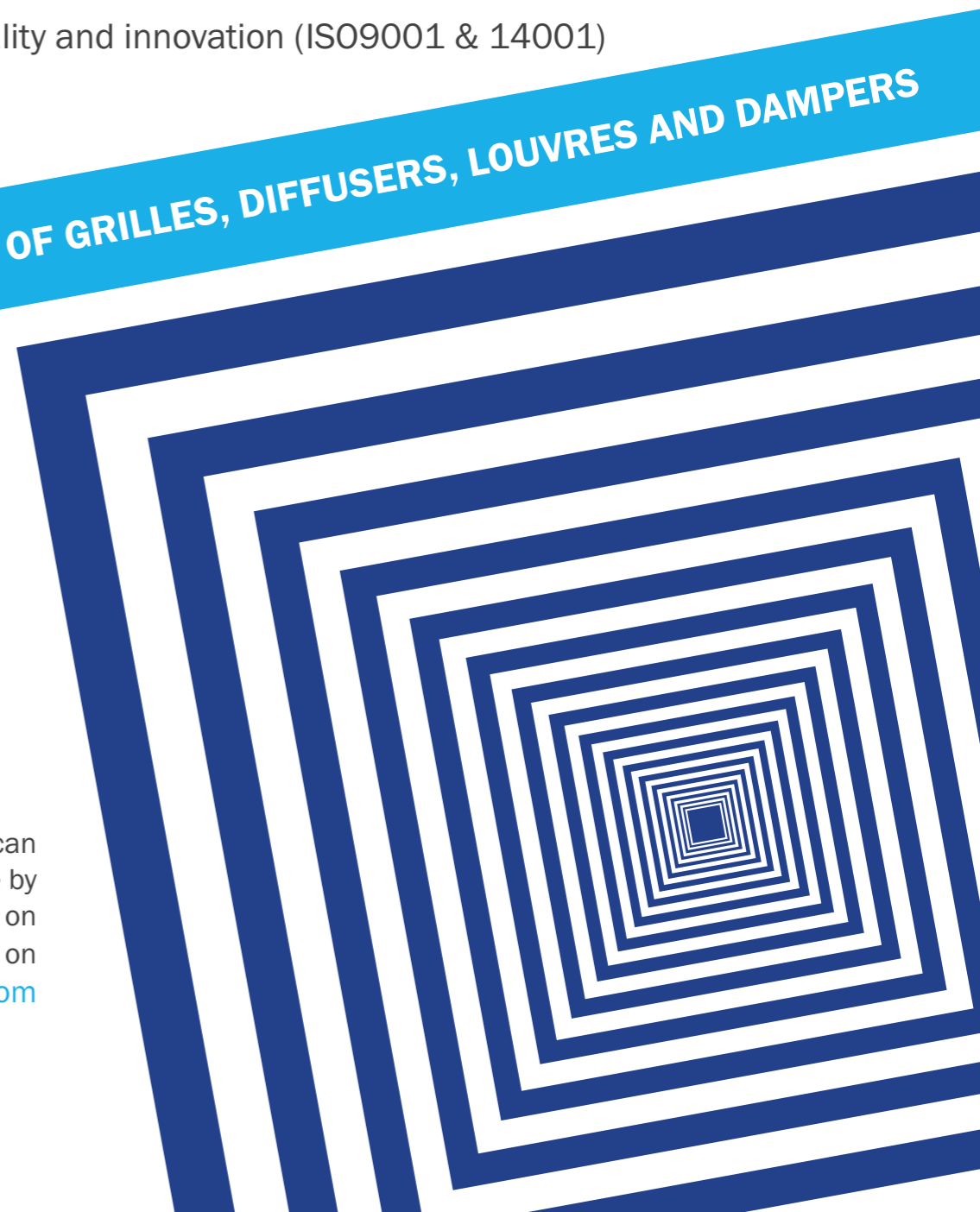

# Swirl Adjustable Diffusers - SWA



Series SW swirl diffusers are very effective supply units, designed to be mounted into a lay-in grid system.

SWA adjustable blade swirls have a fascia formed from a single sheet of steel, but also use individually adjustable blades mounted on moulded plastic holders to allow throw adjustment.

These can be factory fitted with plenum boxes, which also have a range of options including acoustic/thermal lining and spigot mounted single blade volume control dampers.

## Materials:

- Steel fascia and blades
- Moulded plastic blade mounts

## Blades:

- Black, individually adjustable

## Overall Size:

- 595 mm x 595 mm

## Core Diameters:

- 12, 24 and 36 Slots variants

## Mass / Unit:

- 3.5 kg

## Technical Drawings:

- SWA 12 Slot

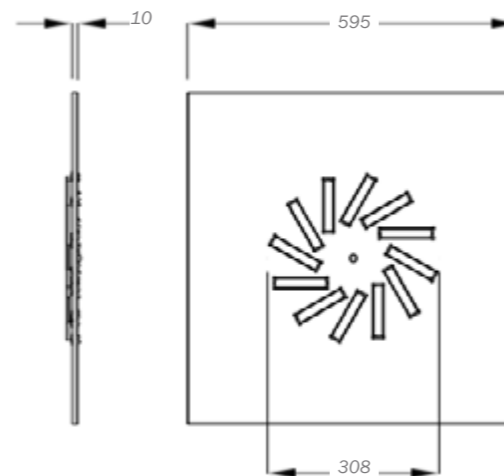

- SWA 24 Slot

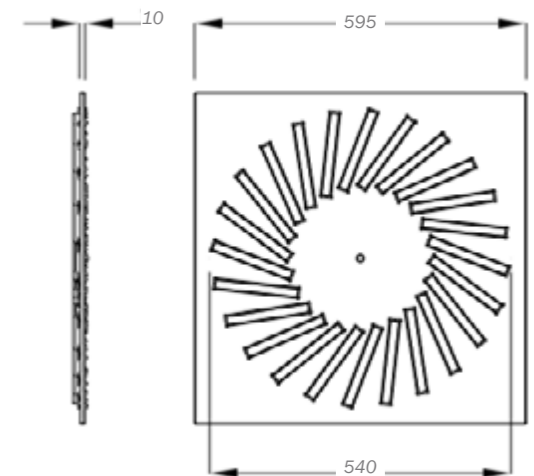

- SWA 36 Slot

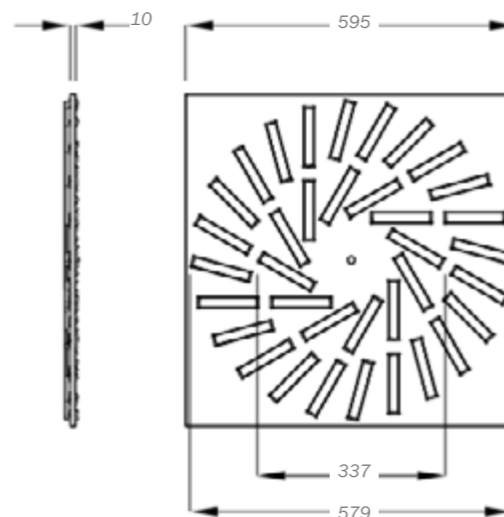

# Swirl Adjustable Diffusers - SWA

## Plenums:

Swirl diffusers are normally supplied factory fitted with plenum boxes to facilitate connection to ductwork.

Boxes are fitted with an internal runner holding a nutsert, a long bolt (supplied by Monodraught) is fitted through a hole in the centre of the swirl diffuser, and screwed into the nutsert.

By tightening the bolt, the swirl is pulled up securely to the box.

Plenums are available with the following range of options:

- Series SBD single blade volume control dampers mounted in the box spigot
- Internal acoustic lining
- Matt black internals





## Finish:

- RAL: Polyester powder coated to RAL
- BS: Polyester powder coated to BS



 Halifax House, High Wycombe  
Buckinghamshire, HP12 3SE

 +44 01494 897700

 +44 01494 532465

 [www.monodraught.com](http://www.monodraught.com)

 [info@monodraught.com](mailto:info@monodraught.com)

 Monodraught Ltd

 @MonodraughtLtd

 Monodraught Ltd

 **Monodraught**<sup>®</sup>  
*engineering delivered. naturally*

