

**drive**

**DeVilbiss**  
HEALTHCARE

Patient lift

**Samsoft Mini**

# USER MANUAL



CE

More informations :



# USER AND MAINTENANCE GUIDE FOR *Samssoft Mini* PATIENT LIFT

## *Samssoft Mini* patient lift

### CONTENTS

I - WARNINGS.....	2
II - SYMBOLS AND EXPLANATION.....	2
III - TECHNICAL SPECIFICATIONS.....	3
3.1 <i>Samssoft Mini</i> .....	3
3.2 Lifting assembly .....	4
IV - INTENDED USE.....	4
V - ASSEMBLY PRINCIPLE.....	4
5.1 General terminology.....	4
5.2 Unpacking.....	5
5.3 Assembly.....	5
5.4 Folding.....	6
VI - USING <i>Samssoft Mini</i> .....	6
6.1 Commissioning.....	7
6.2 Charging.....	7
6.3 Possible problems.....	7
6.4 Battery pack.....	7
VII - TRANSFERRING A PATIENT.....	7
7.1 Base spacing.....	7
7.2 Transferring the patient from a bed to an armchair.....	7
7.3 Transferring the patient from an armchair to a bed.....	7
7.4 Transferring a patient lying on the floor.....	8
7.5 Moving.....	8
VIII - STRAP RANGE FOR <i>Samssoft Mini</i> AND STRAP MAINTENANCE.....	8
8.1 Controls.....	8
8.2 Cleaning.....	8
IX - <i>Samssoft Mini</i> MAINTENANCE.....	8
9.1 Cleaning.....	8
9.2 Disinfecting.....	8
9.3 Daily maintenance.....	8
9.4 Routine maintenance.....	8
9.5 Preventive maintenance.....	9
X - SHIPPING, STORAGE AND DISPOSAL.....	9
XI - WARRANTY CONDITIONS AND RESPONSIBILITIES.....	10
XII - BEFORE CONTACTING Drive DeVilbiss Healthcare France CUSTOMER SERVICE.....	11
XIII - SERVICE BOOK.....	12

 **CAREFULLY READ THIS USING GUIDE BEFORE USER'S THIS DEVICE.**

- Only use the slings provided by Drive DeVilbiss Healthcare France.
- Maximum patient weight: 150 Kg.
- Carefully read the user guide before using this device.
- This device should be used by skilled and experienced staff.
- Never use a defective patient lift.
- Annual preventive maintenance is compulsory and should be performed according to § 9.5.

### I - AVERTISSEMENTS

The renter must inform and show the user how to handle the patient lift stating the precautions and the risks related to inappropriate use. Pinching areas should be explained in details.

The renter should ensure the user perfectly understood the safety instructions.

When mounting and using the device, it is recommended to have the hands away from the pinching areas.

When the patient lift is exposed to heat source (sun rays through a window or radiator) for a long time, ensure there is no burn risk before using the patient lift.

The device should be used in a sufficiently clear place so that manoeuvres are not disturbed. Since the slings are not fireproof, it is forbidden to use the device near flames and to smoke.







Do not use or store the patient lift in a humid area or near water splashing (rain, shower, etc.).

In very particular use situations, the patient lift operation can be disturbed by radio and electromagnetic waves (proximity of radio-telephone antenna, etc.). In case of dysfunction, do not use the patient lift. Its operation can interfere with sensitive electronic devices. In this case, do not use the patient lift.

Because of the component weight and dimensions, there are hazards during dismantling and reassembling, so it is highly recommended being assisted and minding the pinching areas.

Any serious incident related to this device shall be reported to the manufacturer and the competent authority of the Member State in which the user and/or the patient is located.

### II - SYMBOLS AND EXPLANATIONS

	Maximum user weight
	Caution: hazard!
	Carefully read the user manual
	Device compliant to directive 93/42/CEE
	Patient lift manufacturer
	Serial number
	This device is submitted to directive 2002/96/EC relative to waste electric and electronic equipment (WEEE) and it was marketed after 13.08.15.

# USER AND MAINTENANCE GUIDE FOR *Samssoft Mini* PATIENT LIFT

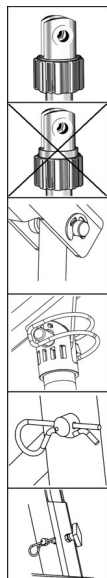

- Check the red emergency lowering ring is in the up position.
- Check the elastic ring is correctly engaged in the groove of the axle.
- Check the spring pin is correctly oriented on either side of the lug and correctly closed.
- Check the beta pin in the lower part of the mast is correctly positioned.
- Check the wing knob is correctly screwed in.

Mechanical cylinder rod disengagement (red ring)	
Battery power supply	2 x 4.5Ah, 12V (included in the battery pack)
External battery charger	
Battery charge indicator	LED
Buttons	Emergency stop and emergency lowering
Cycle number as for patient lift autonomy (lifting/lowering) with an average weight of 100 Kg, with new charged batteries.	80 cycles
EC marking date	2015
Complies with ISO 10535 standard	

## LABEL OF IDENTIFICATION

The label of identification is stuck on the crossbar.

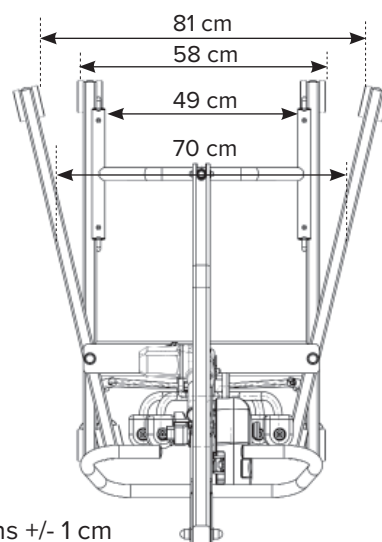
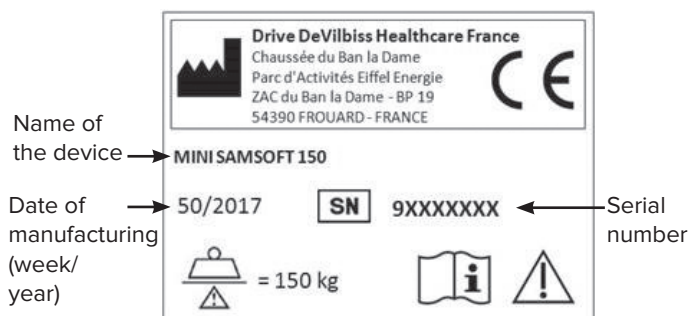

Dimensions +/- 1 cm

## III - SPECIFICATIONS

### 3.1) *Samssoft Mini*

Dimensions (folded)	110 x 58 x 43,5 cm
Dimensions (unfolded)	109 x 58 x 113 cm
Lifting capacity	150 kg
Inner feet spacing	49 cm min. to 81 cm max.
Turning diameter	117 cm
Base height	9 cm
Lifting time	44 s (empty)
Patient lift weight	35 kg
Lifetime	10 000 cycles at 150 kg
Front wheels	dia. 7,5 x 6 cm without brake
Rear wheels	dia. 7,5 x 6 cm with brake
Structure	Steel
Coating	Epoxy RAL 7005 - 7004 - 8000N
Electric cylinder (lifting)	24VCC 8000N

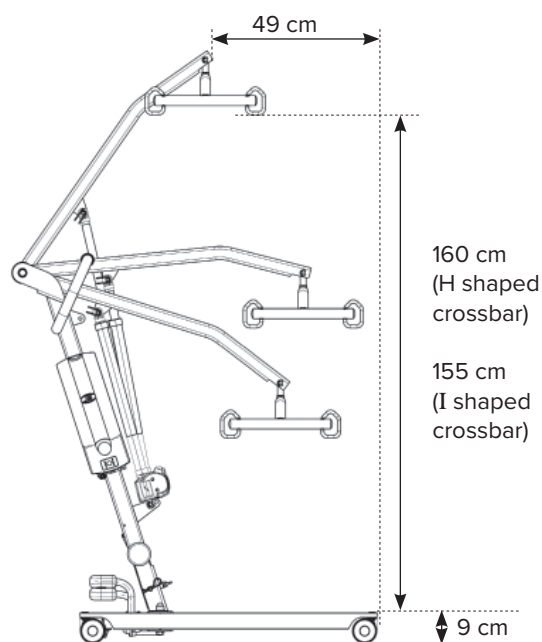

# USER AND MAINTENANCE GUIDE FOR *Samsoft Mini* PATIENT LIFT

**⚠ Important:** the patient lift should be used with slings (safety members) provided by Drive DeVilbiss Healthcare France exclusively

Driven operating force:

- with one finger: < 5N
- with one hand: < 105 N
- with one foot: < 300 N

## 2. Lifting assembly

**Autonomous box :** (control box + battery pack)

Dimensions	L=272 l= 120 h=90 mm
Weight	4,8 Kg
Protection	Current limiter
Output voltage	24 V continuous
Output current	8,5 A max.
Output number	1
Battery capacity	4.5 Ah
Battery voltage	2 batteries 12 V
Autonomy	around 80 cycles
Charging time	8 h
Emergency stop push-button mergency lowering button (1) (2) (photo n°2, page 5) Charged/discharged battery indicator	
Protection	IP 54

**Actuator or cylinder:**

Power supply	24 V DC
Max. center to center distance	895 mm
Max. stroke	300 mm
Max. thrust force	8000 N
Lifting time	38 s (empty) 54 s (with the patient in)
No-load speed	26 mm /s
On-load speed	19 mm /s
Weight	3,5 kg
Protection	IPX4
Mechanical decoupling/Safety nut	
Sound level	≤ 60 dB

**Chargeur de batterie externe :**

Power supply	230V AC 50-60 Hz
Output	24V continuous
Protection	IP20

(We reserve the right to change these specifications without notice).

## IV - UTILISATION PRÉVUE

● This transfer device is intended to transfer mobility-impaired patients; it can be used with a wheelchair, a shower seat, a bed, or a toilet seat.

**Not suitable for children under 12 year-old, for patients with mental disorders, and for patients whose morphology is incompatible with this kind of transfer device**

**⚠ ● *Samsoft Mini* should be used indoors exclusively on a flat and adherent floor; it should be handled by a competent caregiver trained for using this kind of devices.**

## V - ASSEMBLY PRINCIPLE

### 5.1) General terminology

- 1 - Mast
- 2 - Base
- 3 - Cross bar
- 4 - Boom
- 5 - Lifting cylinder
- 6 - Remote control
- 7 - Controle box
- 8 - Battery pack
- 9 - Side rails spacing pedal
- 10 - Side rails

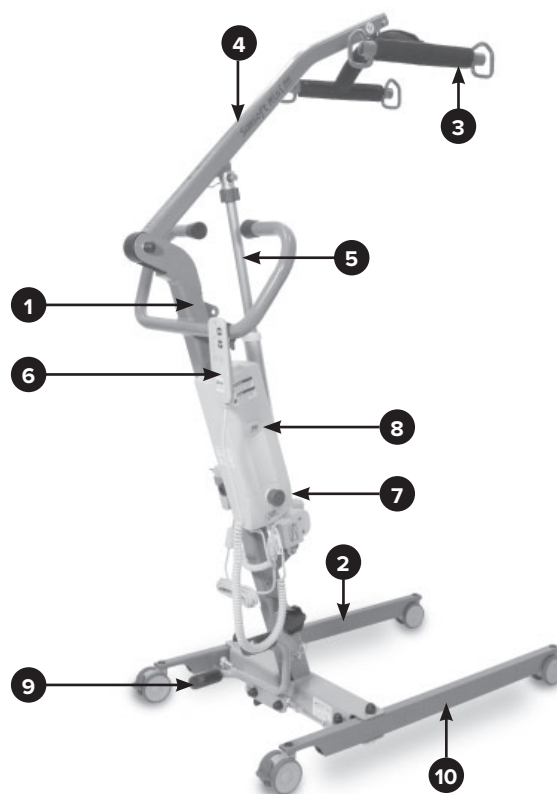

# USER AND MAINTENANCE GUIDE FOR *Samssoft Mini* PATIENT LIFT

## 5.2) Unpacking

Check all the device elements have not been damaged during transport.

Check the accessories are present: the lifting assembly (box with battery pack, cylinder, remote control), battery charger, a user guide, and possibly a strap if it was ordered.

NB: Our device is mounted and tested in our manufacturing site, but its packaging requires it to be folded.

## 5.3) Assembly

### A- Provided parts:

1 - *Samssoft Mini* structure with lifting assembly: box (including battery pack) (photo # 2), cylinder and remote control, battery charger,

2 - *Samssoft Mini* user' guide,

3 - Possibly one strap if it was ordered.

### B - Structure installation:

1 - Remove the structure from the box (possibly by cutting the box angles), lay the structure on a flat floor, and then lock the brakes and wheels.

2 - In the lower part of the mast, after removing the pin (7) (photo # 4), remove mast safety shaft (11) (photo #5).

3 - Straighten up the mast, and then position the mast safety shaft (11) into the second hole (12) and reposition the pin (7) (photo #4). Tighten backlash screw (8) (black wing screw) (photo #4). Put the supply box on its support.

4 - Remove the pin which fixes the head of the jack to the mast (photo 8) then make revolve the mast and the cross-bar of the back of the device forwards (photo 7). Bring the head of the jack on the articulation of the arrow then put back the pin by watching that its ring of safety is closed well.

**⚠ Attention on the weight and on the dimensions of the set and at the risk of possible pinching out.**

5 - Check the box is correctly charged:

- Green: the batteries are totally charged
- Green/yellow: 3/4 charged batteries
- Yellow: 1/2 charged batteries.
- Yellow/red: the batteries are almost discharged, recharge them.
- Red: the batteries are discharged, they should be immediately charged otherwise their service life could be reduced.

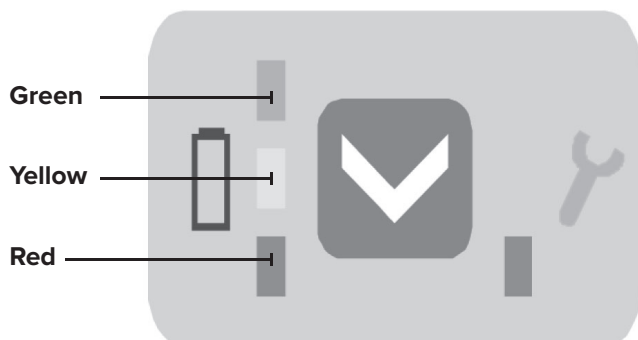

- If the red indicator is lit up (under the small key), the device requires special maintenance, please contact Drive DeVilbiss Healthcare France customer service.

**⚠ CAUTION: before using the device, make sure all the shafts, screws, and pins handled during the installation are perfectly engaged in their respective supports, and they are correctly locked.**

*Samssoft Mini* is operational only if the strap corresponding to this device is used, and only if the maximum 150 kg permissible load is respected.

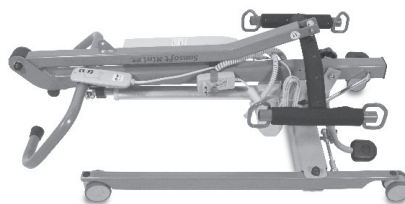

Photo #1 - *Samssoft Mini* when assembled and folded

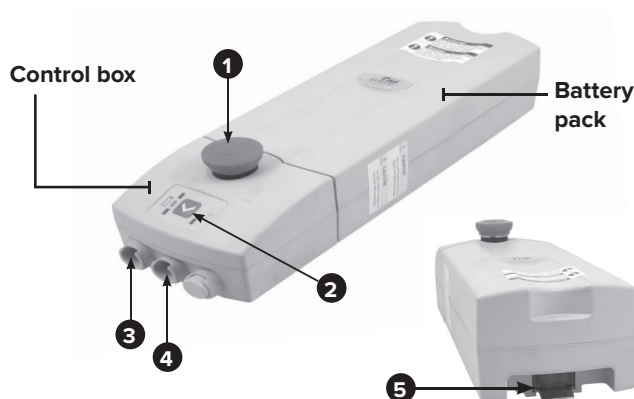

Photo #2 - Supply box (including battery pack)

- 1 - Emergency stop push-button
- 2 - Emergency lowering button
- 3 - Cylinder connection plug
- 4 - Cylinder connection remote control
- 5 - Battery pack unlocking knob

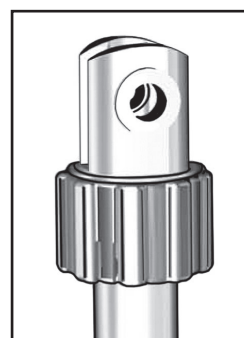

Photo #3

# USER AND MAINTENANCE GUIDE FOR *Samssoft Mini* PATIENT LIFT

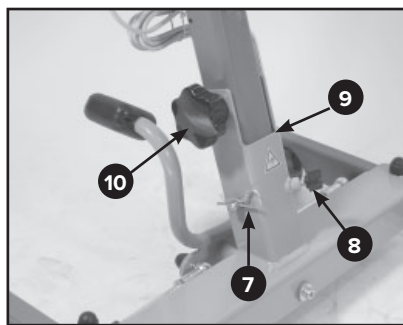

Photo #°4 - Safety pin

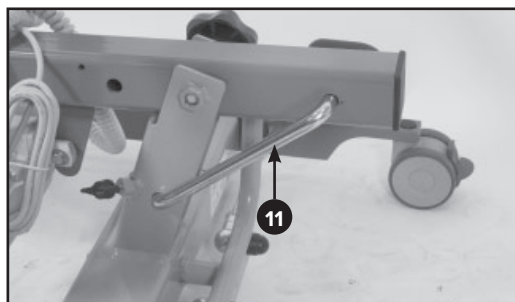

Photo #°5 - Mast safety shaft

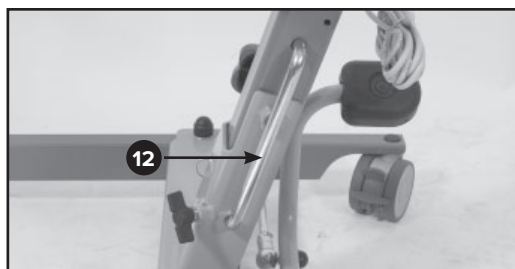

Photo #°6 - Position of the safety shaft when the mast is upright

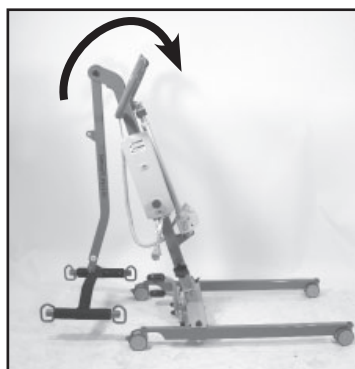

Photo #°7 - Unfolding the boom



Photo #°8 - Pin of the jack

## 5.4) Folding

The device should be folded to be transported. (Photo #°1).

The folding allows to store vertically the device and to transport him in complete safety. To fold up the device, make the operations described in the paragraph 4 but in the inverse order :

- Press on the remote control to lower the arrow up to the low point.
- Remove the jack of the arrow then hang on it on the mast.
- Make revolve the arrow towards the back of patient-lift.
- Fix the cross-bar to the mast.
- Remove the pin (7) and the mast safety shaft (11).
- Lower the assembly mast/boom/cross-bar onto the side rails.

**⚠ CAUTION: pinching risk (9 photo #4)**

- Reposition the mast safety shaft in its 1st position, and put its pin back.
- The device can be vertically transported or stored (photo #9).



Photo #°9

To facilitate the transport of Samssoft Mini, it is possible to defuse him in two parts by unscrewing completely the button (10) photo 4 and by removing the axis of safety (11) photo 5.

**⚠ Warning** Unscrew partially backlash screw (8) photo 4 before separating the mast of the rolling base. After reassembly, verify that all the elements of fixation and the pin of safety are firmly in place. Squeeze strongly the button (10). Weight of the rolling basis: 14 kg - weight of the mast, the arrow and the cross-bar: 21 kg and 17 kg without the pack batteries.



## VI - USING *Samssoft Mini*

**⚠ WARNING**  
*Samssoft Mini* should be used indoors exclusively on a flat and adherent floor; it should be handled by a competent caregiver trained for using this kind of devices.



# USER AND MAINTENANCE GUIDE FOR *Samssoft Mini* PATIENT LIFT

## 6.1) Commissioning

When all the connections are made:

- Use the patient lift with the remote control.
- Check the battery charge (see colour code in Chapt. III. 3 - B-5).
- The patient lift is ready to be used.

## 6.2) Charging

 **THE POWER UNIT SHOULD BE CHARGED EVERY NIGHT.**

 **IT SHOULD BE CHARGED IN A WELL-VENTILATED ROOM. CHECK THE POWER SUPPLY CORD CONDITION BEFORE PLUGGING IT.**

- To charge the battery, remove the battery charger from its support and plug it to the main power.  
When charging, the green indicator is blinking.
- When the indicator is steady green, charging is finished (see colour code in Chap. IV - B-5).
- The patient lift is ready to be used again.



Photo #10

## 6.3) Possible problems

- If the remote control cannot lower the patient, press the emergency-lowering button (2)(photo #2).
- If the indicator is steady red when lowering or lifting the patient, charge the device.
- Check the connections if the remote control or the cylinder does not work.

 **IN CASE OF PROBLEM WHEN LIFTING OR LOWE-RING A PATIENT, PRESS THE EMERGENCY STOP BUTTON (1) (photo # 2), AND THEN RELOAD IT BY PULLING IT.**

**IN CASE OF POWER SUPPLY PROBLEM, IT IS POSSIBLE TO MANUALLY LOWER OR LIFT THE BOOM BY PRESSING AND TURNING THE RED RING LOCATED AT THE END OF THE CYLINDER ROD (photo #3).**

**DO NOT FORGET TO REPOSITION IT.**

 **CAUTION: The cylinder should only be used discontinuously, that is to say: 2 minutes operating, and then 18 minutes resting. Do not exceed 2 minutes operating in continuous.**

Any duty cycle exceeding the above cycle can damage the lifting assembly (cylinder/control box). This damage is excluded from the warranty.

## 6.4) Battery pack

The 2 batteries included in the box of the battery pack do not require any special maintenance. Though, they should be regularly charged to maintain their service life (at least every 3 months). With a second battery pack (available on request), the device can work 24/24 hours.

## VII - TRANSFERRING A PATIENT

**Before positioning and transferring the patient, check that:**

- The patient's weight is compatible with the maximum permissible load of the patient lift (150 kg maximum).
- The batteries are charged and the patient lift is fully operational.
- The floor is flat and stable.
- The patient lift brakes are functional.
- Check the strap is compatible with SAMSOFT Mini (Drive DeVilbiss Healthcare France strap).
- Check the strap fasteners and the patient support elements are in perfect condition.
- In the maintenance book included in this manual, check regular maintenance is performed once a year at least.
- If the patient is agitated, an accompanying person should secure the patient's movement.

 **CAUTION: You should move the patient lift base apart to the maximum before lifting or moving the patient. Do not engage the wheel brakes. Do not keep on lifting or lowering the patient if the 4 wheels are not on the floor. The lifting task should be very progressive checking the patient is well positioned into the strap and there is no tipping risk due to excessive overhanging.**

## 7.1) Base spacing

Press the spacing pedal to open or close the *Samssoft Mini* base.

## 7.2) Transferring the patient from a bed to an armchair

- Position the patient on his/her side.
- Place the strap under the patient.
- Check the back part of the strap is correctly positioned (from shoulders to coccyx).
- Lay the patient on the back.
- Pass each leg support under each thigh.
- Position the patient lift at the patient's level.
- Hook each strap buckle **inside the crossbar hooks**.
- The patient can now be transferred from the bed to an armchair.

## 7.3) Transferring the patient from an armchair to a bed

- Lean the patient forward holding him/her.
- Slip the strap behind the patient's back up to the coccyx.
- Pass each leg support under each thigh.
- Position the patient lift at the patient's level.
- Hook each strap buckle inside the crossbar hooks.
- The patient can now be transferred from an armchair to a bed.

# USER AND MAINTENANCE GUIDE FOR *Samssoft Mini* PATIENT LIFT

## Particular points:

- When positioning the strap, check there is no fold at the leg level in order not to hurt the patient.
- Do not engage the device brakes when lifting so that the device can correctly position with regard to the patient.

 **CAUTION! WHEN LIFTING OR LOWERING A PATIENT, NEVER ENGAGE THE WHEEL BRAKES SO THAT THE DEVICE CAN BE CORRECTLY POSITIONED, IN LINE WITH THE PATIENT. IN CASE OF POWER SUPPLY PROBLEM, IT IS POSSIBLE TO MANUALLY LOWER OR LIFT THE BOOM BY PRESSING AND TURNING THE RED RING LOCATED AT THE END OF THE CYLINDER ROD.**

## 7.4) Transferring a patient lying on the floor

 **The patient's weight should not exceed 150 Kg** and the patient lift should be positioned so that the patient's head and trunk be located inside the side rails. Lift the patient very progressively ensuring he/she is well positioned on the straps.

## 7.5) Moving

Although this operation is strongly not recommended, it is possible to use the patient lift to move the hung patient on a very short distance (ex.: from the bed to the shower).

Use the handles to move and guide the patient lift. Another person should secure the patient.

-  ● **Do not push nor pull the straps or the crossbar to move the patient lift.**
- **Do not move a patient if agitated.**

## VIII - STRAP RANGE FOR *Samssoft Mini* AND MAINTENANCE

**Slings of transfer for bar of prehension in 4 points of attachment. Maxi load 250kg.**

 **Not to exceed the maximum load of raises patient.**

Bath net	Size M
Bath net	Size L
Comfort polyester	Size M
Comfort polyester	Size L
Comfort polyester	Size XL
Bath netted hammock	Size M
Bath netted hammock	Size XL
Toilet netted hammock	Size M
Toilet netted hammock	Size XL

## 8.1) Controls

(before any use, and to be performed by a competent staff)

Before any use, check the condition of the straps. no undone sewing, the upholstery and the straps should not be fringed, no tear and no wear sign (transparent upholstery weft).

## 8.2) Cleaning

(each time it is necessary, and to be performed by a competent staff)

- The polyester straps can be washed at 40°C at the maximum. For other straps, see the strap instructions.
- The straps should be disinfected with detergent solutions (see below Chap. IX-2).

## IX - *Samssoft Mini* MAINTENANCE

 **Disconnect the power supply cord and remove the battery pack before any maintenance operation.**

### 9.1) Cleaning

(every month or when necessary, and to be performed by a competent staff)

- Clean the patient lift with a soft cloth dampened with soapy solution, then rinse, and carefully dry.
- Do not use aggressive detergent; do not soak.

### 9.2) Disinfecting

(when necessary, and to be performed by a competent staff)

- Disinfecting is performed with detergents and disinfecting solutions sprayed on the external chair areas. It is a foaming solution that does not require rinsing, but only drying.

Our internal services use ANIOS solutions.

### 9.3) Daily maintenance

- Charge the battery pack every night.

### 9.4) Routine maintenance

(every month or when necessary, and to be performed by a competent staff)

The routine maintenance consists in checking the system functionality:

- With the bed positioned on a flat floor, check its 4 wheels are touching the floor.
- When the brakes are engaged, the patient lift should not be moved (flat and adhered floor).
- Operate the patient lift with nobody in, check the arm and the side rails move steadily with no noise.
- Control the handles located on the mast and check there is no play between the arm and the mast, and between the mast and the side rails.
- Check the plastic protective housings and casings are not broken or cracked, and all parts are present.
- Check the condition of the connecting cables: power supply cord, remote control and cylinder; if a cable shows a slight burn, wear, or impact sign, or if the wires are visible, immediately stop using the patient lift, and have the cables replaced by the engineering department.
- The slings should be checked at least once a month, or more regularly in case of intensive use, ensuring the seams are not



# USER AND MAINTENANCE GUIDE FOR *Samssoft Mini* PATIENT LIFT

undone, the upholstery and sling webbing is not visible, and there is no torn part.

Never use a defective sling.

 **The worn or malfunctioning parts should be replaced with original parts manufactured by Drive DeVilbiss Healthcare France.**

**Have some tries with a load before commissioning the patient lift again.**

## 9.5) Preventive maintenance

Every year or when necessary, and to be performed by a competent staff, according to paragraphs 9.5.1, 9.5.2, and 9.5.3 below.

- It is necessary to control the device every year.
- The battery pack should be changed about every 18 months depending on how it is used.
- The crossbar suspension axle should be imperatively checked yearly on each maintenance task.

The yearly maintenance should be performed by skilled technical staff experienced with electromechanical device maintenance. The maintenance tasks do not require particular tools; adequate tools should be used according to the best industry practices. Mechanical fastening, plays, and adjustments should be realised according to the best industry practices.

### 9.5.1) Mechanical control :

- Disassembly and systematic lubrication of the crossbar axle. In case of any wear sign, the axle should IMPERATIVELY be replaced.

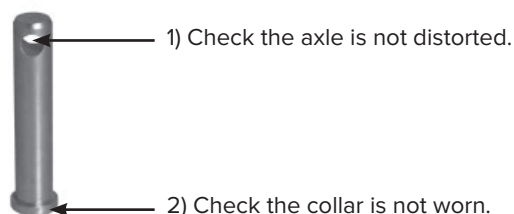

- Dismantling, cleaning, and lubrication of the front and rear casters.
- Control and lubrication after dismantling the mast and side rail pivots.
- Check the welding. Visual inspection.
- Check the alignments. Visual inspection.
- Control and lubrication of the cylinder fastenings.
- Check the tightening of all the parts.
- Dismantling, cleaning, and lubrication of the mast hinge.

Check the fastening, caster play, and brake performance. The mechanical parts that have cracks, wear signs or geometrical defects should be replaced with original components delivered by Drive DeVilbiss Healthcare France.

### 9.5.2) Electrical inspection :

- Check the remote control. Reminder: the remote control does not enter the warranty field.

- Check the charger.
- Check the remote control box and the cylinder.
- Check the lifting/lowering speed.
- Check the emergency stop and lowering.
- Condition of the electric cables (change the cables in case of doubt).

Replace the electric cables and/or the components to which they are connected if there are signs of wear, sheath cut, outlet damage or plastic and sheath darkening around the coupling area. Replace the electric cables and/or the components to which they are connected if there are signs of wear, sheath cut, outlet damage or plastic and sheath darkening around the coupling area.

**Note :** Never disassemble the protective housings of the cylinder, battery pack, remote control and control box, and battery charger.

### 9.5.3) Charging test:

- Charge the battery pack.
- Check the battery pack power and autonomy.
- Test the device when fully loaded (150 kg) and control the power cut threshold (230 kg +/- 10 kg).
- Tests.
- Battery pack should be changed every 18 months, depending on use.

### 9.5.5) Service book:

Every maintenance operation or intervention should be recorded in the service book attached to these instructions.

## X - SHIPPING, STORAGE, AND DISPOSAL

- The patient lift should be returned or transported in its original packaging.
- Before storing the patient lift, clean it totally and check its performance. Store the patient lift in a dry place away from dust and humidity. The batteries should be totally charged every 3 months.
- When commissioning, after storing, charge the battery pack, and check its performance before using it again.
- Storage temperature: between 0 and + 50°C Humidity between 10 and 80%
- Service temperature: between +10 and + 40°C Humidity between 30 and 80%

- The disposal of defective parts, packaging and battery pack should be performed by approved waste treatment centres.



- The involved system should not be disposed of with household waste, but should be sent to an appropriate waste collection point or to a distributor.
- A financial contribution is given for collecting, dismantling, and recycling the system in question.
- By respecting these instructions, you respect the environment and participate in protecting the natural resources and the human health.

## **XI - WARRANTY CONDITIONS AND RESPONSIBILITIES**

*Samssoft Mini* is warranted for 5 years as far as the structure, the cylinder and the control box are concerned, and in case of normal use according to the instructions given in this guide.

Negligence, handling errors and accidents are excluded from the warranty. The remote control is guaranteed for 3 months, and the battery pack is guaranteed for 6 months.

**Any modification or addition of accessories without Drive DeVilbiss healthcare France's written consent will de facto exclude the product from the warranty and from Drive DeVilbiss healthcare France liability. In particular, using straps that are not marketed by Drive DeVilbiss healthcare France for this patient lift will not entail our liability.**

The regular checks and inspections mentioned in the previous paragraph should be performed by a competent staff and recorded in the maintenance book. **Out of the warranty period, our liability will not be entailed if you do not respect these controls and inspections.**

**Only spare parts and components provided by Drive DeVilbiss Healthcare France can be used to repair the device.**

In case of unsolved technical problems, please contact the Customer Service:

Tél. : +33(0)3.83.495.451

Fax : +33(0)3.83.494.391

E-mail : sav@drivedevilbiss.fr

# USER AND MAINTENANCE GUIDE FOR *Samssoft Mini* PATIENT LIFT

## XII - BEFORE CONTACTING DRIVE DEVILBISS HEALTHCARE FRANCE CUSTOMER SERVICE

Calling the Customer Service can often be avoided!

If the patient lift does not perfectly works, please perform the following checks first:

PROBLEM	POSSIBLE CAUSE	REMEDY
<b>Nothing happens when one of the remote control keys is pressed.</b>	<ul style="list-style-type: none"> <li>▶ The remote control cord is not correctly plugged in its slot.</li> <li>▶ The remote control cable is cut.</li> <li>▶ The battery pack is not supplied</li> <li>▶ The battery pack is discharged.</li> <li>▶ The cylinder connection plug is not correctly plugged.</li> <li>▶ The cylinder power cord is cut</li> </ul>	<ul style="list-style-type: none"> <li>▶ Correctly insert the plug.</li> <li>▶ Replace the remote control.</li> <li>▶ Release the red push-button</li> <li>▶ Charge the battery pack.</li> <li>▶ Correctly insert the plug.</li> <li>▶ Replace the cylinder.</li> </ul>
<b>A cylinder produces abnormal noise.</b>	<ul style="list-style-type: none"> <li>▶ The duty cycle 2 min./18 min. was not respected.</li> <li>▶ The pinion or the nut supporting the lifting tube is damaged.</li> </ul>	<ul style="list-style-type: none"> <li>▶ Send the cylinder for an inspection to Drive DeVilbiss Healthcare France Customer Service.</li> <li>▶ Send the cylinder for an inspection to Drive DeVilbiss Healthcare France Customer Service</li> </ul>
<b>The cylinder works, but very slowly.</b>	<ul style="list-style-type: none"> <li>▶The power supply cord is not correctly connected.</li> <li>▶ There is no voltage on the mains outlet.</li> </ul>	<ul style="list-style-type: none"> <li>▶ Check the mains outlet connection.</li> <li>▶ Check the wall socket is a mains socket.</li> </ul>
<b>The batteries do not charge.</b>	<ul style="list-style-type: none"> <li>▶ The power supply cord is not correctly connected.</li> <li>▶ There is not voltage no the mains outlet.</li> </ul>	<ul style="list-style-type: none"> <li>▶ Check the mains outlet connection.</li> <li>▶ Check the wall socket is a mains socket.</li> </ul>
<b>The red indicator under the small key is on..</b>	<ul style="list-style-type: none"> <li>▶ The device requires special maintenance.</li> </ul>	<ul style="list-style-type: none"> <li>▶ Contact drive DeVilbiss Healthcare France Customer Service.</li> </ul>
<b>The yellow control box indicator lights up.</b>	<ul style="list-style-type: none"> <li>▶ The battery pack is half charged.</li> </ul>	<ul style="list-style-type: none"> <li>▶ Plan to charge the battery pack.</li> </ul>
<b>No control box indicator lights up.</b>	<ul style="list-style-type: none"> <li>▶The battery pack is out of order.</li> </ul>	<ul style="list-style-type: none"> <li>▶ Change the battery pack.</li> </ul>
<b>The red control box indicator lights up.</b>	<ul style="list-style-type: none"> <li>▶The battery pack is discharged.</li> </ul>	<ul style="list-style-type: none"> <li>▶ Immediately charge the battery pack.</li> </ul>
<b>The red emergency lowering ring turns on the cylinder rod.</b>	<ul style="list-style-type: none"> <li>▶The cylinder rod is disengaged.</li> </ul>	<ul style="list-style-type: none"> <li>▶ Push the ring upwards.</li> </ul>

# USER AND MAINTENANCE GUIDE FOR *Samssoft Mini* PATIENT LIFT

## XIII - SERVICE BOOK

DEVICE SERIAL NUMBER : .....

COMPAGNY : .....

This document should be photocopied and delivered to the technician every time the patient lift is maintained.  
In case of incident, the liability can only be determined if all the sheets of this book are completed

DATE	Intervention nature: Check, inspection, quotation, repairing, etc.	Intervention description	Technician's name and position

Ref. M54068500 - 03/2019 - Rév. 2

Cachet

 **Drive DeVilbiss Healthcare France**

Chaussée du Ban la Dame - Parc d'activités Eiffel Energie  
ZAC du Ban la Dame - BP 19 - 54390 FROUARD - FRANCE  
Tél. +33(0)3 83 495 495 - Fax +33(0)3 83 495 496