

CleanSwitch opbouwdoos

Montage-instructie

Algemeen

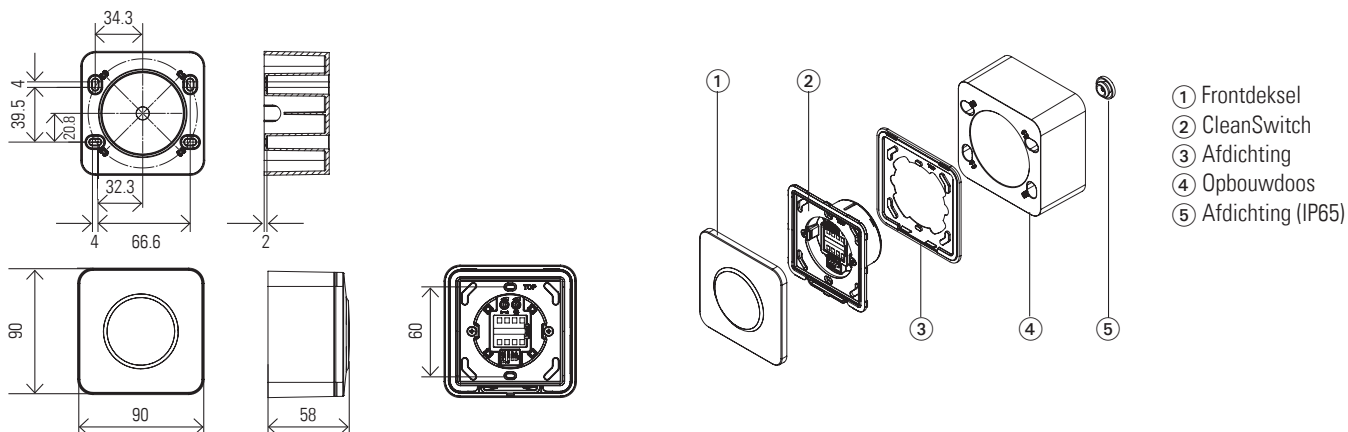

1 Montage

1 Gewenste IP-bescherming en kabelpositionering

IP65

of

IP54

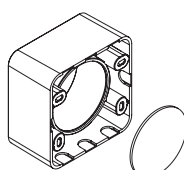
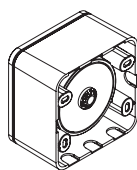

Deksel uitbreken

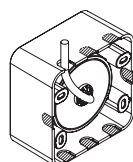

Uitbreekvenster met tang uitbreken volgens de gewenste kabelpositionering

2

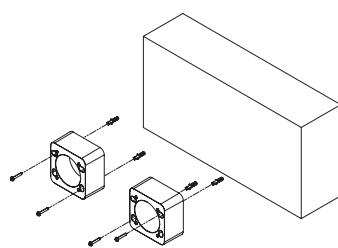

Opbouwdoos diagonaal met 2 schroeven bevestigen

3

IP65

of

IP54

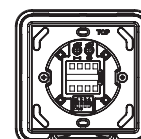
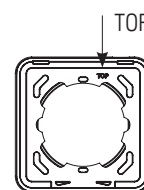
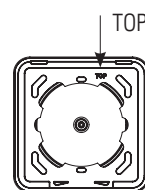

4

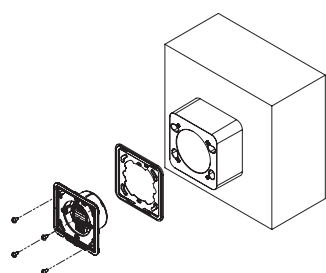

Afdichting zoals gemarkeerd op opbouwdoos inleggen

5

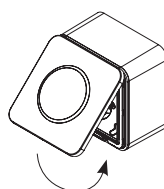

Deksel boven inhangen

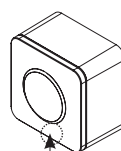

Indrukken tot de klik!

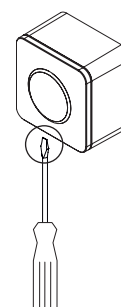

Demontage

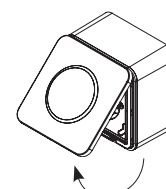

2 Contact

Optex Technologies BV, Henricuskade 17, 2497 NB The Hague, The Netherlands, www.optex.eu, +31-70 419 41 00, info@optex.eu

Made in China / Designed in Switzerland