



OA-FLEX AIR T



COMPLIED STANDARDS AND EXTRACT FROM EC DECLARATION OF CONFORMITY

EN 16005:2012/AC:2015 Chapter 4.6.8 and Annex C
 EN 61496-3:2001 clause 4. 3. 5 and 5. 4. 7. 3
 DIN 18650-1:2010 Chapter 5.7.4 ESPE
 EN 12978:2003 +A1:2009
 EN ISO 13849-1:2015
 EN ISO 13849-2:2012
 EN 61000-6-2:2005/AC:2005
 EN 61000-6-3:2007 +A1:2011/AC:2012
 Machinery Directive 2006/42/EC
 EMC Directive 2014/30/EU

Notified Body 0044 : TÜV NORD CERT GmbH, Langemarckstr. 20, 45141, Essen, Germany

A. Maekawa
 General Manager
 OPTEX CO., LTD.
 Quality Control Dept.

5923781 MAY 2017
 NI-0066-3
 Original instructions

MANUFACTURER'S STATEMENT

Read this operation manual carefully before use to ensure proper operation of this product. Failure to read this operation manual may cause improper operation and may result in serious injury or death of a person. The meanings of the symbols are as follows.

	WARNING	Disregard of warning may cause the improper operation causing death or serious injury of a person.
	CAUTION	Disregard of caution may cause the improper operation causing injury of a person or damage to objects.
	NOTE	Special attention is required to the section of this symbol.
		It is required to check the operation manual if this symbol is shown on the product.

- NOTE**
- This product is a non-contact switch intended for header mount or wall mount for use on an automatic sliding door. Do not use for any other applications.
 - When setting the sensor's detection area, make sure that there is no traffic around the installation site.
 - Before turning the power ON, check the wiring to prevent damage or malfunction of equipment connected to the product.
 - Only use the product as specified in the operation manual provided.
 - Be sure to install and adjust the sensor in accordance with the local laws and standards of the country in which the product is installed.
 - Before leaving the installation site make sure that the product is operating properly and instruct the building owner/operator on proper operation of the door and the product.
 - The product settings can only be changed by an installer or service engineer. When changed, the changed settings and the date shall be registered in the maintenance logbook accompanying the door.

	WARNING	Do not wash, disassemble, rebuild or repair the sensor, otherwise it may cause electric shock or breakdown of the equipment.
Danger of electric shock.		

- NOTE** The following conditions are not suitable for sensor installation :
- Fog or exhaust emission around the door.
 - Moving objects or objects that emit light near the detection field.
 - Highly reflecting floor or highly reflecting objects around the door.
 - Wet floor.
 - Grating floor.

WORKING PRINCIPLE

This sensor is designed to detect a hand approaching to a touchless plate as a knowing act activation device. Please make sure to understand the following working principle. If FLEX EYE mode is enabled (Dipswitch 14 is set to "ON"), this sensor an activation output when both FLEX EYE and 2nd to 4th row of detection area detect some objects. FLEX EYE means an area for the hand detection.

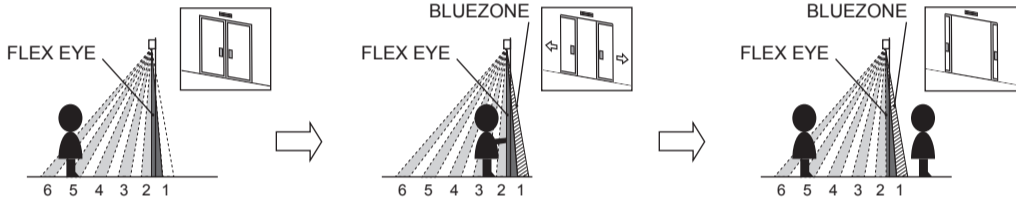

- NOTE** Safety output is designed to be used on door system that enables only while the door is open. BLUEZONE is only activated while Activation output is emitted. When no detection, BLUEZONE is deactivated. When FLEX EYE is enabled (Dipswitch 14 is set to "ON"), detection area (of 2nd to 6th row) is safety output area.

SPECIFICATIONS

Model	: OA-FLEX AIR T	Safety output	: Opto coupler (NPN)
Cover color	: Silver / Black	Voltage / 5 to 50VDC	
Mounting height	: 2.0m(6'7") to 2.5m(8'2")(*1)	Current / 100mA Max.	
Detection area	: See DETECTION AREA	(Resistance load)	
Detection method	: Active infrared reflection(*2)	Dark current / 600nA Max.	
Area angle adjustment : Depth	: -8° to +8°	Operating temperature: -20 to +55°C (-4 to 131°F)	
	Width : ±7°	Operating humidity : < 80%	
FLEX EYE	: (2 clicks with 3.5° every click-Left/Right)	Noise level : < 70dBA	
angle adjustment	: Depth : -14° to +2°	Output hold time : Approx. 0.5sec.	
	Width : ±42°	Response time : < 0.3sec.	
	: (7 clicks with 6° every click-Left/Right)	IP rate : IP54	
Power supply (*3)	: 12 to 24VAC ±10% (50 / 60Hz)	Category : 2 (EN ISO 13849-1:2015)	
	12 to 30VDC ±10%	Performance level : d (EN ISO 13849-1:2015)	
Power consumption	: < 2.5W (< 6VA at AC)	ESPE : Type2	
Operation indicator	: See Operation indicator table	Weight : 230g (8.1oz)	
Safety input	: Opto coupler	Accessories	: 1 Operation manual
	Voltage / 5 to 30VDC		: 2 Mounting screws
	Current / 6mA Max. (30VDC)		: 1 Mounting template
Activation output	: Form A relay		: 1 Area adjustment tool
	50V 0.3A Max. (Resistance load)		: 1 Cable 3m(9'10")
			: (8 × 0.22mm ² AWG24) (*4)

Operation indicator table

Status	Operation indicator color	1sec.	1sec.
Set-up	Yellow Blinking	█	█
Stand-by (Installation mode)	Yellow	█	█
Stand-by (Operation mode)	Green	█	█
BLUEZONE (1st row) detection (*5)	Blue	█	█
2nd row detection	Red Blinking	█	█
3rd row detection	Red	█	█
4th-6th row detection	Orange	█	█
FLEX EYE detection	Fast Purple Blinking	█	█
FLEX EYE & 2nd-4th row detection	Purple	█	█
Signal saturation	Slow Green Blinking	█	█
Signal saturation (FLEX EYE)	Slow Purple Blinking	█	█
Sensor failure	Fast Green Blinking	█	█
Setting error	Red & Green Blinking	█	█

- NOTE** The specifications herein are subject to change without prior notice due to improvements.
- *1 : Installation height up to 3.0m(9'10") when no need for EN 16005 compliance.
 - *2 : BLUEZONE (1st row), 2nd and 3rd rows have a presence detection function.
 - *3 : When using this sensor, the sensor has to be connected to a door system which has the SELV circuit.
 - *4 : Overcurrent protection with less than 2A. *5 : See **BLUEZONE AREA**

OUTER DIMENSIONS AND PART NAMES

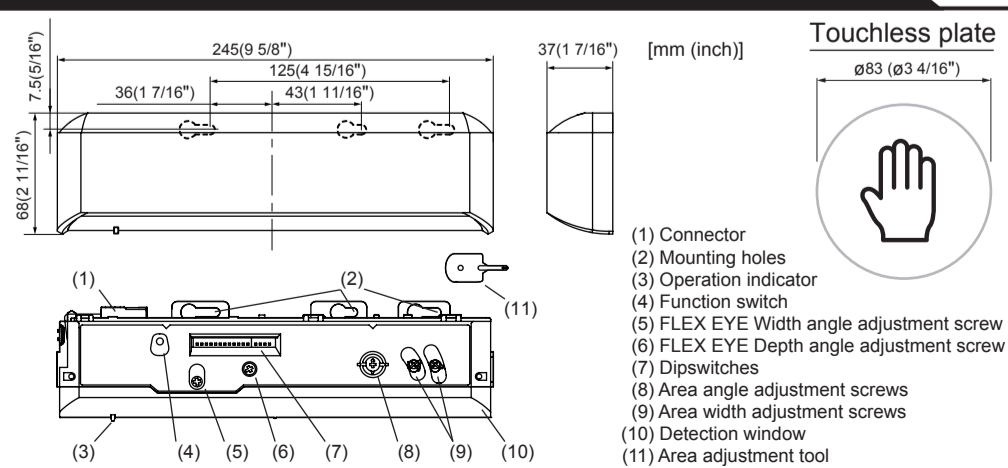

BLUEZONE AREA

When dipswitch 15 is set to "ON", the BLUEZONE area is active and looks through the threshold. In case the BLUEZONE function is not required, set dipswitch 15 to "OFF". Do not overlap the 2nd row into the threshold area, regardless of dipswitch 15 setting.

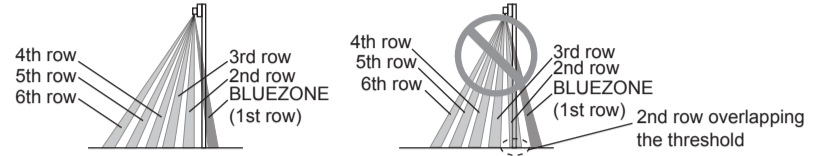

DETECTION AREA

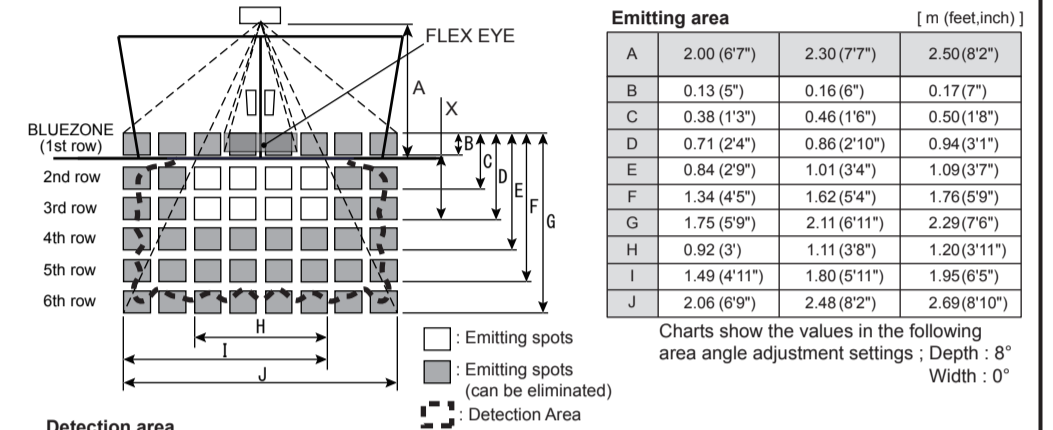

Charts show the values in the following area angle adjustment settings ; Depth : 8° Width : 0°

Detection area

To comply with EN 16005, make sure that the detection area is within the values of the chart below.

	2.00 (6'7")	2.30 (7'7")	2.50 (8'2")
A	2.00 (6'7")	2.30 (7'7")	2.50 (8'2")
X	0.24 (9")	0.25 (10")	0.23 (9")
H	0.85 (2'9")	0.91 (2'12")	0.96 (3'2")
J	2.01 (6'7")	2.20 (7'3")	2.44 (8')

Test conditions required by EN 16005
 Floor : Grey paper
 Detection object : EN 16005 CA reference body
 Sensitivity : High
 Speed of detection object : 50mm / sec.

The values above are those of the **Detection area** when tested referring to the test conditions of EN 16005. (The emitting area is as shown in **Emitting area** above.)

- NOTE** The actual detection area may become smaller depending on the ambient light, the color / material of the object or the floor as well as the entry speed of the object. The sensor may not be activated when the entering speed of the object or a person is slower than 50mm / sec. or faster than 1500mm / sec.

INSTALLATION

- Affix the mounting template at the desired mounting position. (When setting the detection area close to the door, mount the sensor according to the chart below.)
- Drill two mounting holes of ø3.4mm (ø1/8").
- To pass the cable through the header, drill a wiring hole of ø10mm (ø3/8").
- Remove the mounting template.
- Remove the housing cover. Fix the sensor to the mounting surface with the two mounting screws.

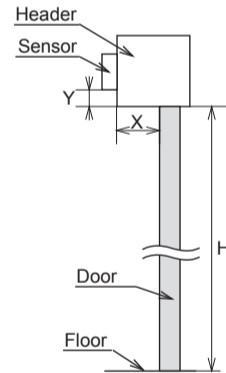

H : Height from the floor to the bottom of the header
 (The mounting height is "H + Y")
 Y : Distance between the bottom of the header and the sensor
 X : Distance between the door and the mounting surface

Maximum mounting distance (Y) [m (feet,inch)]

X	H	2.00 (6'7")	2.30 (7'7")	2.50
0		0.14 (5 1/2")	0.14 (5 1/2")	0.14 (5 1/2")
0.05 (2")		0.13 (5")	0.13 (5")	0.13 (5")
0.10 (4")		0.11 (4")	0.11 (4")	0.11 (4")
0.15 (6")		0.10 (3 1/2")	0.10 (3 1/2")	0.10 (3 1/2")
0.20 (8")		0.09 (3 1/2")	0.09 (3 1/2")	0.09 (3 1/2")
0.25 (10")		0.07 (2 1/2")	0.07 (2 1/2")	0.07 (2 1/2")
0.30 (12")		0.06 (2")	0.06 (2")	0.06 (2")

CAUTION

Risk of getting caught. Make sure to affix the mounting template as described in the above chart, otherwise it can be dangerous since there may be no detection area around the threshold. Install the sensor as low as possible on the header.

2

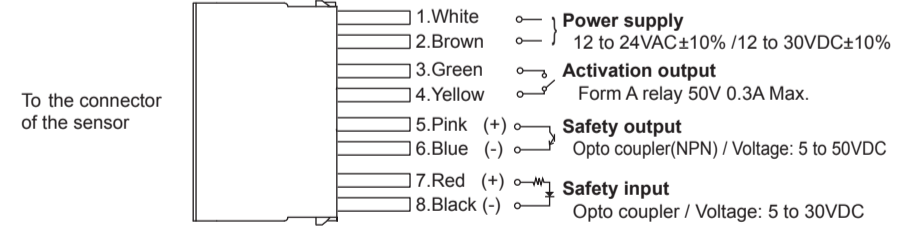

WARNING

Danger of electric shock. Before starting the procedure, make sure that the power is turned OFF. When passing the cable through the hole, do not tear the shield. otherwise it may cause electric shock or breakdown of the sensor.

3

- Plug the connector.
- Supply power to the sensor. Adjust the detection area and set the dipswitches. (See **ADJUSTMENTS 4. Dipswitch settings**)

- NOTE** Make sure to connect the cable correctly to the door controller before turning the power ON. When turning the power ON or after adjusting the settings, do not enter the detection area for more than 10 seconds in order to enable the presence detection. Do not touch the dipswitches before turning the power ON, otherwise an error occurs. When changing the settings of dipswitch, see **ADJUSTMENTS 4. Dipswitch settings**

4

- Place the housing cover. If wiring is to be exposed, break the knockout.

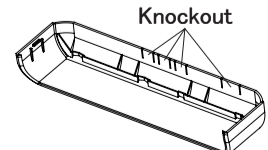

WARNING

Danger of electric shock. Do not use the sensor without the cover. When using the cable knockout, install the sensor indoors or use the rain-cover (Separately available) otherwise electric shock or breakdown of the sensor may occur.

ADJUSTMENTS

1 Area angle adjustment

1-1. Area depth angle adjustment

When adjusting the 2nd row close to the door, see dipswitch 16 in **Dipswitch settings table** and **REFERENCE** for the easier adjustment.

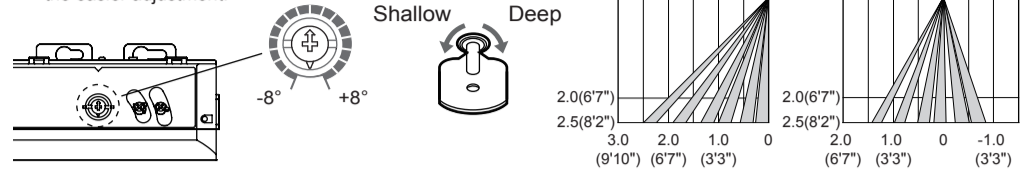

NOTE Make sure that the detection area does not overlap with the door / header, and there is no highly reflecting object near the detection area otherwise ghosting / signal saturation may occur.

1-2. Area width angle adjustment

The angle of the detection area can both be moved 7° either left or right in 2 steps.

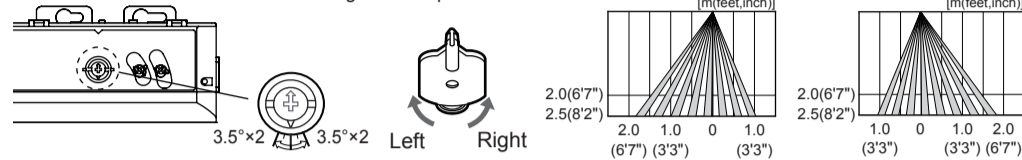

2 Area width adjustment

Adjust the detection area width with the adjustment screws.

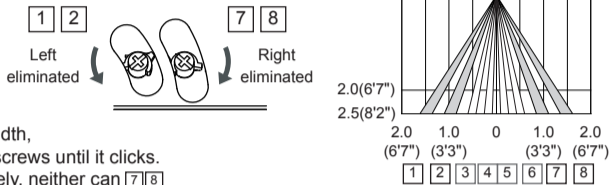

NOTE When setting the detection area width, make sure to turn the adjustment screws until it clicks. [1][2] cannot be eliminated separately, neither can [7][8]

3 FLEX EYE angle adjustment

Make sure to adjust the FLEX EYE angle depending on the door type and the intended touchless plate position otherwise the sensor may not detect when a hand is approached.

3-1. FLEX EYE width angle adjustment

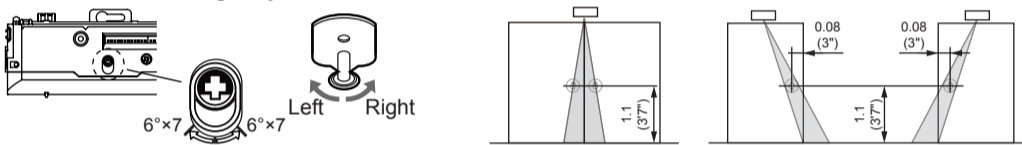

3-2. FLEX EYE depth angle adjustment

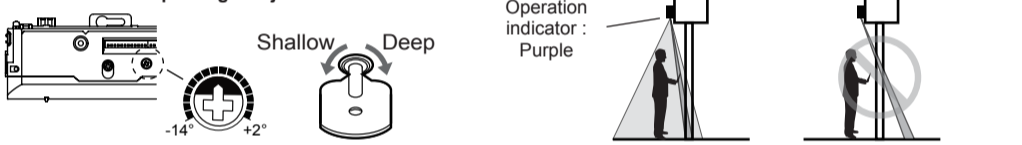

NOTE After adjusting the angle, make sure that the FLEX EYE is placed on the proper position for your use. Affix the touchless plate on the appropriate position after adjusting the FLEX EYE.

CAUTION Make sure to affix the touchless plate where a hand is not caught by the door during door opening and closing.

4 Dipswitch settings

After changing the dipswitch settings, make sure to push the function switch for 2 seconds.

Dipswitch	Function	Setting				Comment
Dipswitch 1	Sensitivity	Low 1	High 1			Set the detection area sensitivity according to the mounting height.
Dipswitch 2	Presence timer	30sec.	60sec.	180sec.	600sec.	The presence timer is applied to BLUEZONE(1st row), 2nd row and 3rd row. The presence timer can be selected from 4 settings.
Dipswitch 3		2 3	2 3	2 3	2 3	
Dipswitch 4	Frequency	Setting 1	Setting 2	Setting 3	Setting 4	When using more than one sensor close to each other, set the frequency different for each sensor.
Dipswitch 5		4 5	4 5	4 5	4 5	
Dipswitch 6	Row adjustment	6rows	5rows	4rows	3rows	Set the depth rows with dipswitches 6 and 7.
Dipswitch 7		6 7	6 7	6 7	6 7	
Dipswitch 8	Immunity	OFF 8	ON 8			Set dipswitch 8 to "ON" when the sensor operates by itself (Ghosting).
Dipswitch 9	Activation output	N.O. 9	N.C. 9			Dipswitch 9 is for the Activation output to door controller.
Dipswitch 10	Self Monitoring	Enable 10	Disable 10			When the door remains open and the operation indicator shows Fast/Slow Green Blinking, refer to TROUBLESHOOTING . If the door still remains open, set dipswitch 10 to "Disable". To comply with EN 16005, set dipswitch 10 to "Enable".
Dipswitch 11	Safety output	High 11	Low 11			Dipswitch 11 is for the Safety output (to door controller).
Dipswitch 12	Safety input	High 12	Low 12			Dipswitch 12 is for the Safety input (from door controller).
Dipswitch 13	FLEX EYE sensitivity	Low 13	High 13			Adjust sensitivity for FLEX EYE.
Dipswitch 14	FLEX EYE mode	ON 14	OFF 14			Select the FLEX EYE mode "ON" or "OFF". ON : Activation output is emitted when a detection occurs in FLEX EYE and the 2nd to 4th row. OFF : Activation output is emitted when a detection occurs in the 2nd to 6th row.
Dipswitch 15	BLUEZONE (1st row)	OFF 15	ON 15			When dipswitch 15 is set to "ON", the BLUEZONE (1st row) is active and looks through the threshold.
Dipswitch 16	Installation mode	OFF 16	ON 16			Set dipswitch 16 to "ON" to adjust the 2nd row. During the installation mode only the 2nd row remains active and the operation indicator shows yellow. After setting the row switch dipswitch 16 "OFF".

CHECKING

Check the operation according to the chart below.

Entry	Power OFF	Outside of detection area	Entry into 4th to 6th row	Entry into 3rd row	Entry into 2nd row	Entry into FLEX EYE and 2nd to 4th row
Image						
Status	-	Stand-by	Motion detection active	Motion / Presence detection active		
Operation indicator	None	Green	Orange	Red	Red blinking	Purple
Activation output (*1)	9 N.O. 9 N.C.					
Safety output	11 High 11 Low	OFF	ON	OFF		
		OFF	ON	ON		

Entry	Entry into BLUEZONE(*2)	Outside of detection area	Entry into FLEX EYE only
Image			
Status	Motion / Presence detection active	Stand-by	Motion detection active
Operation indicator	Blue	Green	Fast Purple Blinking
Activation output (*1)	9 N.O. 9 N.C.		
Safety output	11 High 11 Low	OFF	ON
	ON	OFF	OFF

NOTE

*1 : Activation output shows the status of when FLEX EYE mode is enabled. (Dipswitch 14 is set to "ON".)
*2 : When dipswitch 15 is set to "ON".

INFORM BUILDING OWNER / OPERATOR OF THE FOLLOWING ITEMS

WARNING

- Always keep the detection window clean. If dirty, wipe the window with a damp cloth. (Do not use any cleaner / solvent.)
- Do not wash the sensor with water.
- Do not disassemble, rebuild or repair the sensor yourself, otherwise electric shock may occur.
- When the operation indicator blinks Green, contact your installer or service engineer.
- Always contact your installer or service engineer when changing the settings.
- Do not paint the detection window.

NOTE

- When turning the power ON, always walk-test the detection area to ensure the proper operation.
- Do not place any objects that move or emit light in the detection area. (e.g. Plant, illumination, etc.)

TROUBLESHOOTING

Door operation	Operation indicator	Possible cause	Possible countermeasures
Door does not open when a person enters the detection area and FLEX EYE.	None	Wrong power supply voltage. Wrong wiring or connection failure.	Set to the stated voltage. Check the wires and connector.
	Unstable	Wrong detection area(2nd to 4th row) and FLEX EYE positioning.	Check ADJUSTMENT 1,2,3 (*)
		Sensitivity of detection area(2nd to 4th row) is too low.	Set the detection area sensitivity higher.
		Sensitivity of FLEX EYE is too low.	Set the FLEX EYE sensitivity higher.
		Short presence timer. Dirty detection window.	Set the presence timer longer. Wipe the detection window with a damp cloth. Do not use any cleaner or solvent.
	Proper	Wrong wiring or connection failure.	Check the wires and connector.
Door opens when a person enters the detection area.	Proper	FLEX EYE function is not working. (Dipswitch 15 is up side position)	Check ADJUSTMENT 4 dipswitch 14.(*)
	Unstable	Objects that move or emit light in the detection area.	Remove the objects.
The detection area overlaps with that of another sensor.		Check ADJUSTMENT 4 dipswitch 4,5.(*)	
Waterdrops on the detection window.		Use the rain-cover (Separately available). Wipe the detection window with a damp cloth. Do not use any cleaner or solvent. Install in a place keeping the waterdrops off.	
The detection area overlaps with the door/header.		Adjust the detection area to "Deep"(Outside).	
Sensitivity of detection area is too high.		Set the detection area sensitivity lower.	
Sensitivity of FLEX EYE is too high.		Set the FLEX EYE sensitivity lower.	
Door remains open	Proper	Wrong setting of dipswitches.	Check ADJUSTMENT 4 dipswitch 9,11,12.(*)
	Yellow	Sudden change in the detection area.	Check ADJUSTMENT 4 dipswitch 1 to 3.(*) If the problem still persists, hard-reset the sensor.(Turn the power OFF and ON again.)
		Wrong wiring or connection failure.	Check the wires and connector.
	Fast Green Blinking	Installation mode is set to "ON".	Set dipswitch 16 to "OFF".(*)
		Sensitivity of detection area is too low. Sensitivity of FLEX EYE is too low. Dirty detection window.	Set the detection area sensitivity higher. Set the FLEX EYE sensitivity higher. Wipe the detection window with a damp cloth. Do not use any cleaner or solvent.
	Slow Green Blinking	Sensor failure.	Contact your installer or service engineer.
Signal saturation. (2nd and/or 3rd row)		Remove highly reflecting objects from the detection area. Lower the sensitivity.(*) Change the area depth angle.	
Red & Green Blinking	The detection area overlaps with the door/header.	Adjust the detection area to "Deep" (Outside).	
	Setting error.	After changing the dipswitch settings, make sure to push the function switch for 2 seconds.	
Proper operation	Slow Green Blinking	Signal saturation. (4th, 5th, 6th row and/or BLUEZONE)	Remove highly reflecting objects from the detection area. Lower the sensitivity.(*) Change the area depth angle.
	Slow Purple Blinking	Signal saturation. (FLEX EYE) FLEX EYE overlaps with the header.	Remove highly reflecting objects from the FLEX EYE. Lower the FLEX EYE sensitivity. Change the area depth angle for FLEX EYE. Adjust FLEX EYE to "Deep" (Outside).

* : After changing the dipswitch settings, make sure to push the function switch for 2 seconds.

REFERENCE

Area depth adjustment with INFRARED FINDER (Separately available)

- Turn the depth angle adjustment screw to the right (Deep) to place the detection area most away from the door.
- Set INFRARED FINDER sensitivity to "H" (High) and place it on the floor as shown below.

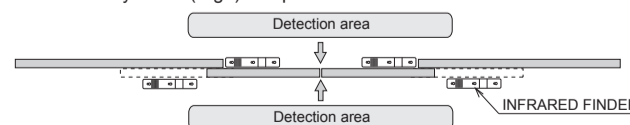

- Turn the depth angle adjustment screw to the left (Shallow) until the emitting area is placed at the position where INFRARED FINDER is in the low detection status (Slow Red Blinking).

Manufacturer

OPTEX CO., LTD.
5-8-12 Ogoto Otsu 520-0101, Japan
TEL.: +81(0)77 579 8700 FAX.: +81(0)77 579 7030
WEBSITE: www.optex.net

European Subsidiary

OPTEX Technologies B.V.
Henricuskade 17, 2497 NB The Hague, The Netherlands
TEL.: +31(0)70 419 41 00 FAX.: +31(0)70 317 73 21
E-MAIL: info@optex.eu WEBSITE: www.optex.eu