



# OA-FLEX T

CE ENGLISH

## COMPLIED STANDARDS AND EXTRACT FROM EC DECLARATION OF CONFORMITY

EN 16005:2012/AC:2015 Chapter 4.6.8 and Annex C  
 EN 61496-3:2001 clause 4. 3. 5 and 5. 4. 7. 3  
 DIN 18650-1:2010 Chapter 5.7.4 ESPE  
 Machinery Directive 2006/42/EC  
 Notified Body 0044 : TÜV NORD CERT GmbH, Langemarckstr. 20, 45141, Essen, Germany

EMC Directive 2014/30/EU  
 EN 12978:2003 +A1:2009  
 EN 61000-6-2:2005/AC:2005  
 EN 61000-6-3:2007 +A1:2011/AC:2012

EN ISO 13849-1:2015  
 EN ISO 13849-2:2012

A. Maekawa  
 General Manager  
 OPTEX CO., LTD.  
 Quality Control Dept.

For technical document, see European Subsidiary

5923771 MAY 2017

NI-0060-3 Original instructions

### MANUFACTURER'S STATEMENT

Read this operation manual carefully before use to ensure proper operation of this product. Failure to read this operation manual may cause improper operation and may result in serious injury or death of a person. The meanings of the symbols are as follows.

	<b>WARNING</b>	Disregard of warning may cause the improper operation causing death or serious injury of a person.
	<b>CAUTION</b>	Disregard of caution may cause the improper operation causing injury of a person or damage to objects.
	<b>NOTE</b>	Special attention is required to the section of this symbol.
		It is required to check the operation manual if this symbol is shown on the product.

**NOTE**

- This product is a non-contact switch intended for header mount or wall mount for use on an automatic sliding door. Do not use for any other applications.
- When setting the sensor's detection area, make sure that there is no traffic around the installation site.
- Before turning the power ON, check the wiring to prevent damage or malfunction of equipment connected to the product.
- Only use the product as specified in the operation manual provided.
- Be sure to install and adjust the sensor in accordance with the local laws and standards of the country in which the product is installed.
- Before leaving the installation site make sure that the product is operating properly and instruct the building owner/operator on proper operation of the door and the product.
- The product settings can only be changed by an installer or service engineer. When changed, the changed settings and the date shall be registered in the maintenance logbook accompanying the door.

	<b>WARNING</b>	Do not wash, disassemble, rebuild or repair the sensor, otherwise it may cause electric shock or breakdown of the equipment.
<b>Danger of electric shock.</b>		

**NOTE** The following conditions are not suitable for sensor installation :

- Fog or exhaust emission around the door.
- Moving objects or objects that emit light near the detection field.
- Highly reflecting floor or highly reflecting objects around the door.
- Wet floor.
- Grating floor.

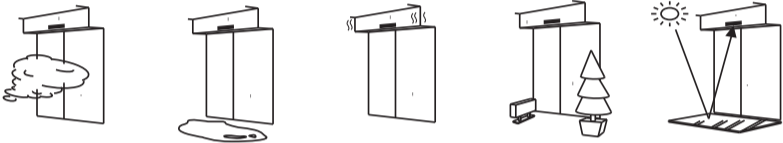

### SPECIFICATIONS

Model	: OA-FLEX T	Operating temperature	: -20 to +55°C (-4 to 131°F)
Cover color	: Silver / Black	Operating humidity	: < 80%
Mounting height	: 2.0m(6'7") to 2.5m(8'2")(*1)	Noise level	: < 70dBA
Detection area	: See <b>DETECTION AREA</b>	Output hold time	: Approx. 0.5sec.
Detection method	: Active infrared reflection(*2)	Response time	: < 0.3sec.
Area angle adjustment	: Depth : -8° to +8° Width : ±7°	IP rate	: IP54
Power supply (*3)	: 12 to 24VAC ±10% (50 / 60Hz) 12 to 30VDC ±10%	Category	: 2 (EN ISO 13849-1:2015)
Power consumption	: < 2.0W (< 5VA at AC)	Performance level	: d (EN ISO 13849-1:2015)
Operation indicator	: See <b>Operation indicator table</b>	ESPE	: Type2
Safety input	: Opto coupler Voltage / 5 to 30VDC Current / 6mA Max. (30VDC)	Weight	: 220g (7.8oz)
Activation output	: Form A relay 50V 0.3A Max. (Resistance load)	Accessories	: 1 Operation manual 2 Mounting screws 1 Mounting template 1 Area adjustment tool 1 Cable 3m(9'10") (8 × 0.22mm <sup>2</sup> AWG24) (*4)
Safety output	: Opto coupler (NPN) Voltage / 5 to 50VDC Current / 100mA Max. (Resistance load) Dark current / 600nA Max.		

#### Operation indicator table

Status	Operation indicator color	1sec.	1sec.
Set-up	Yellow Blinking	[Blinking bar]	[Blinking bar]
Stand-by (Installation mode)	Yellow	[Solid bar]	[Solid bar]
Stand-by (Operation mode)	Green	[Solid bar]	[Solid bar]
BLUEZONE (1st row) detection (*5)	Blue	[Solid bar]	[Solid bar]
2nd row detection	Red Blinking	[Blinking bar]	[Blinking bar]
3rd row detection	Red	[Solid bar]	[Solid bar]
4th-6th row detection	Orange	[Solid bar]	[Solid bar]
Signal saturation	Slow Green Blinking	[Blinking bar]	[Blinking bar]
Sensor failure	Fast Green Blinking	[Blinking bar]	[Blinking bar]
Setting error	Red & Green Blinking	[Blinking bar]	[Blinking bar]

- NOTE** The specifications herein are subject to change without prior notice due to improvements.
- \*1 : Installation height up to 3.0m(9'10") when no need for EN 16005 compliance.
  - \*2 : BLUEZONE (1st row), 2nd and 3rd rows have a presence detection function.
  - \*3 : When using this sensor, the sensor has to be connected to a door system which has the SELV circuit.
  - \*4 : Overcurrent protection with less than 2A. \*5 : See **BLUEZONE AREA**

### OUTER DIMENSIONS AND PART NAMES

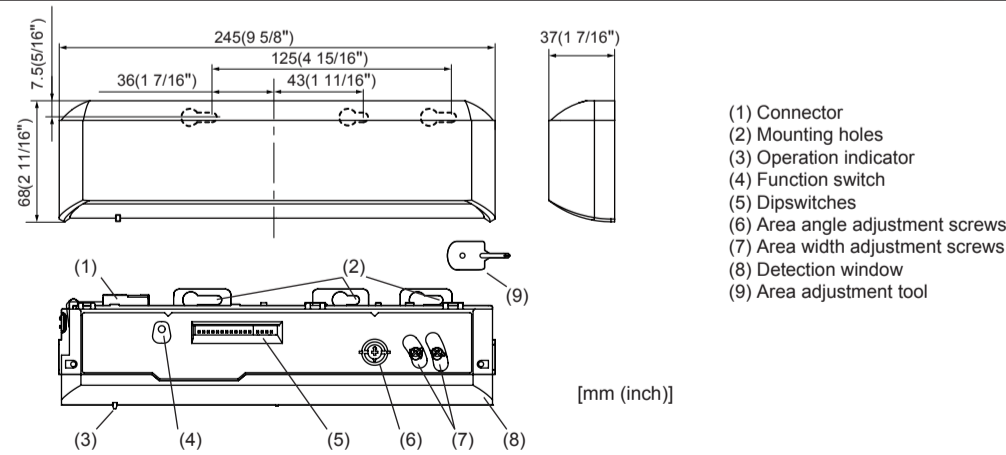

### BLUEZONE AREA

When dipswitch 15 is set to "ON", the BLUEZONE area is active and looks through the threshold. In case the BLUEZONE function is not required, set dipswitch 15 to "OFF". Do not overlap the 2nd row into the threshold area, regardless of dipswitch 15 setting.

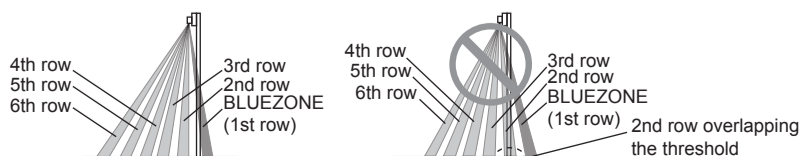

### DETECTION AREA

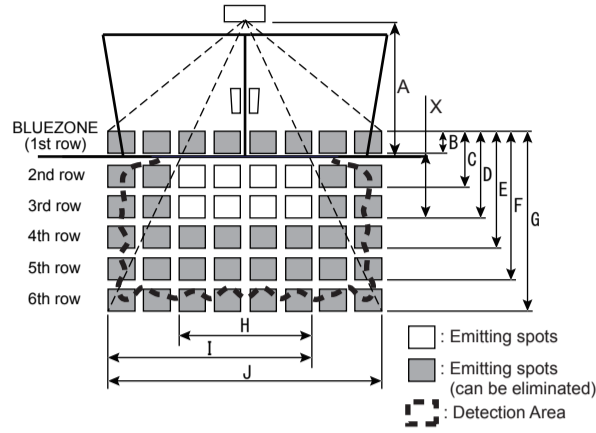

Emitting area [m (feet,inch)]			
A	2.00 (6'7")	2.30 (7'7")	2.50 (8'2")
B	0.13 (5")	0.16 (6")	0.17 (7")
C	0.38 (1'3")	0.46 (1'6")	0.50 (1'8")
D	0.71 (2'4")	0.86 (2'10")	0.94 (3'1")
E	0.84 (2'9")	1.01 (3'4")	1.09 (3'7")
F	1.34 (4'5")	1.62 (5'4")	1.76 (5'9")
G	1.75 (5'9")	2.11 (6'11")	2.29 (7'6")
H	0.92 (3')	1.11 (3'8")	1.20 (3'11")
I	1.49 (4'11")	1.80 (5'11")	1.95 (6'5")
J	2.06 (6'9")	2.48 (8'2")	2.69 (8'10")

Charts show the values in the following area angle adjustment settings ; Depth : 8° Width : 0°

#### Detection area

To comply with EN 16005, make sure that the detection area is within the values of the chart below.

A	2.00 (6'7")	2.30 (7'7")	2.50 (8'2")
X	0.24 (9")	0.25 (10")	0.23 (9")
H	0.85 (2'9")	0.91 (2'12")	0.96 (3'2")
J	2.01 (6'7")	2.20 (7'3")	2.44 (8')

Test conditions required by EN 16005

- Floor : Grey paper
- Detection object : EN 16005 CA reference body
- Sensitivity : High
- Speed of detection object : 50mm / sec.

The values above are those of the **Detection area** when tested referring to the test conditions of EN 16005. (The emitting area is as shown in **Emitting area** above.)

**NOTE**

The actual detection area may become smaller depending on the ambient light, the color / material of the object or the floor as well as the entry speed of the object. The sensor may not be activated when the entering speed of the object or a person is slower than 50mm / sec. or faster than 1500mm / sec.

### INSTALLATION

- Affix the mounting template at the desired mounting position. (When setting the detection area close to the door, mount the sensor according to the chart below.)
- Drill two mounting holes of ø3.4mm (ø1/8").
- To pass the cable through the header, drill a wiring hole of ø10mm (ø3/8").
- Remove the mounting template.
- Remove the housing cover. Fix the sensor to the mounting surface with the two mounting screws.

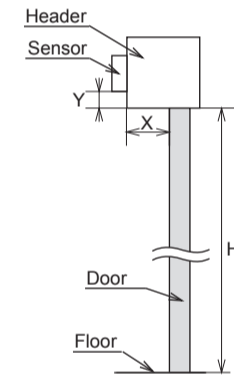

H : Height from the floor to the bottom of the header (The mounting height is "H + Y")  
 Y : Distance between the bottom of the header and the sensor  
 X : Distance between the door and the mounting surface

Maximum mounting distance (Y) [m (feet,inch)]

X	H	2.00(6'7")	2.30 (7'7")	2.50 (8'2")
0	0.14 (5 1/2")	0.14 (5 1/2")	0.14 (5 1/2")	0.14 (5 1/2")
0.05 (2")	0.13 (5")	0.13 (5")	0.13 (5")	0.13 (5")
0.10 (4")	0.11 (4")	0.11 (4")	0.11 (4")	0.11 (4")
0.15 (6")	0.10 (3 1/2")	0.10 (3 1/2")	0.10 (3 1/2")	0.10 (3 1/2")
0.20 (8")	0.09 (3 1/2")	0.09 (3 1/2")	0.09 (3 1/2")	0.09 (3 1/2")
0.25 (10")	0.07 (2 1/2")	0.07 (2 1/2")	0.07 (2 1/2")	0.07 (2 1/2")
0.30 (12")	0.06 (2")	0.06 (2")	0.06 (2")	0.06 (2")

	<b>CAUTION</b>	Make sure to affix the mounting template as described in the above chart, otherwise it can be dangerous since there may be no detection area around the threshold. Install the sensor as low as possible on the header.
<b>Risk of getting caught.</b>		

### 2

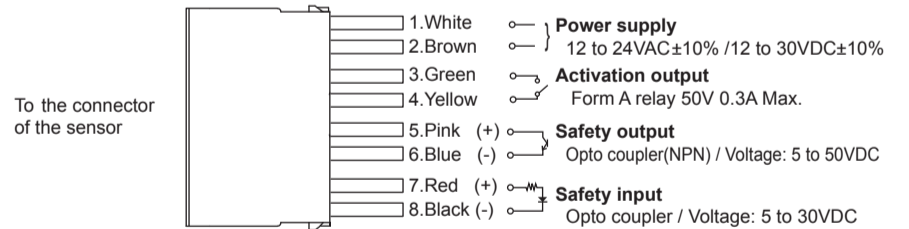

	<b>WARNING</b>	Before starting the procedure, make sure that the power is turned OFF. When passing the cable through the hole, do not tear the shield. otherwise it may cause electric shock or breakdown of the sensor.
<b>Danger of electric shock.</b>		

### 3

- Plug the connector.
- Supply power to the sensor. Adjust the detection area and set the dipswitches. (See **ADJUSTMENTS 3. Dipswitch settings**)

**NOTE**

Make sure to connect the cable correctly to the door controller before turning the power ON. When turning the power ON or after adjusting the settings, do not enter the detection area for more than 10 seconds in order to enable the presence detection. Do not touch the dipswitches before turning the power ON, otherwise an error occurs. When changing the settings of dipswitch, see **ADJUSTMENTS 3. Dipswitch settings**

### 4

- Place the housing cover. If wiring is to be exposed, break the knockout.

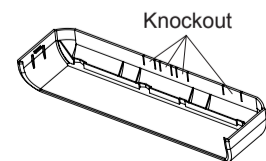

	<b>WARNING</b>	Do not use the sensor without the cover. When using the cable knockout, install the sensor indoors or use the rain-cover (Separately available) otherwise electric shock or breakdown of the sensor may occur.
<b>Danger of electric shock.</b>		

## ADJUSTMENTS

### 1 Area angle adjustment

#### 1-1. Area depth angle adjustment

When adjusting the 2nd row close to the door, see dipswitch 16 in **Dipswitch settings table** and **REFERENCE** for the easier adjustment.

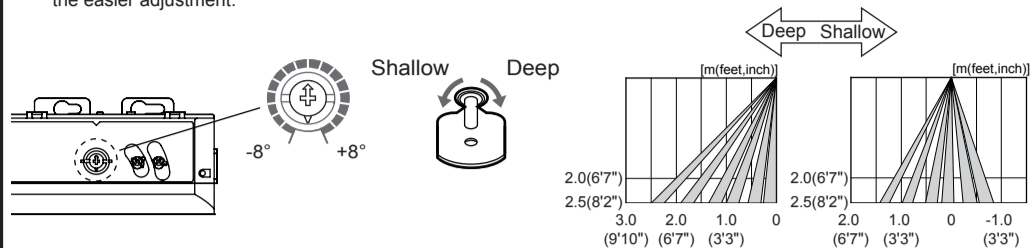

**NOTE** Make sure that the detection area does not overlap with the door / header, and there is no highly reflecting object near the detection area otherwise ghosting / signal saturation may occur.

#### 1-2. Area width angle adjustment

The angle of the detection area can both be moved 7° either left or right in 2 steps.

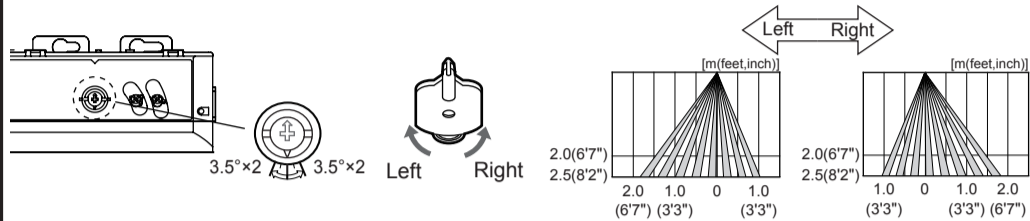

### 2 Area width adjustment

Adjust the detection area width with the adjustment screws.



**NOTE** When setting the detection area width, make sure to turn the adjustment screws until it clicks. [1][2] cannot be eliminated separately, neither can [7][8].

### 3 Dipswitch settings

After changing the dipswitch settings, make sure to push the function switch for 2 seconds.

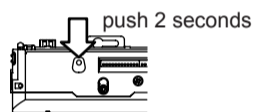

#### Dipswitch settings table

Dipswitch	Function	Setting				Comment
		Low	High			
Dipswitch 1	Sensitivity					Set the sensitivity according to the mounting height.
Dipswitch 2	Presence timer	30sec.	60sec.	180sec.	600sec.	The presence timer is applied to BLUEZONE(1st row), 2nd row and 3rd row. The presence timer can be selected from 4 settings.
Dipswitch 3						
Dipswitch 4	Frequency	Setting 1	Setting 2	Setting 3	Setting 4	When using more than one sensor close to each other, set the frequency different for each sensor.
Dipswitch 5						
Dipswitch 6	Row adjustment	6rows	5rows	4rows	3rows	Set the depth rows with dipswitches 6 and 7.
Dipswitch 7						
Dipswitch 8	Immunity	OFF	ON			Set dipswitch 8 to "ON" when the sensor operates by itself (Ghosting).
Dipswitch 9	Activation output	N.O.	N.C.			Dipswitch 9 is for the Activation output to door controller.
Dipswitch 10	Self Monitoring	Enable	Disable			When the door remains open and the operation indicator shows Fast/Slow Green Blinking, refer to <b>TROUBLESHOOTING</b> . If the door still remains open, set dipswitch 10 to "Disable". To comply with EN 16005, set dipswitch 10 to "Enable".
Dipswitch 11	Safety output	High	Low			Dipswitch 11 is for the Safety output (to door controller).
Dipswitch 12	Safety input	High	Low			Dipswitch 12 is for the Safety input (from door controller).
Dipswitch 13		N/A				
Dipswitch 14	Simultaneous output	OFF	ON			When Dipswitch 14 is set to "ON", both Activation & Safety output will operate simultaneously regardless of detection area. But only Safety output will respond back with Safety output when it receives Safety input.
Dipswitch 15	BLUEZONE (1st row)	OFF	ON			When dipswitch 15 is set to "ON", the BLUEZONE (1st row) is active and looks through the threshold.
Dipswitch 16	Installation mode	OFF	ON			Set dipswitch 16 to "ON" to adjust the 2nd row. During the installation mode only the 2nd row remains active and the operation indicator shows yellow. After setting the row switch dipswitch 16 "OFF".

## CHECKING

Check the operation according to the chart below.

Entry	Power OFF	Outside of detection area	Entry into 4th to 6th row	Entry into 3rd row	Entry into 2nd row	Entry into BLUEZONE (*)
Image						
Operation indicator	None	Green	Orange	Red	Red blinking	Blue
Status	-	Stand-by	Motion detection active	Motion / Presence detection active		
Activation output	9 N.O.					
	9 N.C.					
Safety output	11 High	OFF	ON	OFF	OFF	OFF
	11 Low	OFF	OFF	ON	ON	ON
14	OFF	OFF	ON	ON	ON	ON
	ON	OFF	OFF	OFF	OFF	ON

**NOTE** \*: When dipswitch 15 is set to "ON".

## INFORM BUILDING OWNER / OPERATOR OF THE FOLLOWING ITEMS

### ! WARNING

- Always keep the detection window clean. If dirty, wipe the window with a damp cloth. (Do not use any cleaner / solvent.)
- Do not wash the sensor with water.
- Do not disassemble, rebuild or repair the sensor yourself, otherwise electric shock may occur.
- When the operation indicator blinks Green, contact your installer or service engineer.
- Always contact your installer or service engineer when changing the settings.
- Do not paint the detection window.

**NOTE** 1. When turning the power ON, always walk-test the detection area to ensure the proper operation.  
2. Do not place any objects that move or emit light in the detection area. (e.g. Plant, illumination, etc.)

## TROUBLESHOOTING

Door operation	Operation indicator	Possible cause	Possible countermeasures
Door does not open when a person enters the detection area.	None	Wrong power supply voltage. Wrong wiring or connection failure.	Set to the stated voltage. Check the wires and connector.
	Unstable	Wrong detection area positioning. Sensitivity is too low. Short presence timer. Dirty detection window.	Check <b>ADJUSTMENTS 1, 2.</b> (*) Set the sensitivity higher.(*) Set the presence timer longer.(*) Wipe the detection window with a damp cloth. Do not use any cleaner or solvent.
	Proper	Wrong wiring or connection failure.	Check the wires and connector.
Door opens when no one is in the detection area. (Ghosting)	Unstable	Objects that move or emit light in the detection area. The detection area overlaps with that of another sensor. Waterdrops on the detection window.	Remove the objects. Check <b>ADJUSTMENTS 3</b> dipswitch 4,5.(*) Use the rain-cover. (Separately available) Wipe the detection window with a damp cloth. Do not use any cleaner or solvent. Install in a place keeping the waterdrops off.
	Proper	The detection area overlaps with the door/header. Sensitivity is too high. Others	Adjust the detection area to "Deep" (Outside). Set the sensitivity lower.(*) Set dipswitch 8 to "ON".(*)
		Wrong setting of dipswitches.	Check <b>ADJUSTMENTS 3</b> dipswitch 9,11,12.(*)
Door remains open	Proper	Sudden change in the detection area. Wrong wiring or connection failure.	Check <b>ADJUSTMENTS 3</b> dipswitch 1 to 3.(*) If the problem still persists, hard-reset the sensor. (Turn the power OFF and ON again.) Check the wires and connector.
	Yellow	Installation mode is set to "ON".	Set dipswitch 16 to "OFF".(*)
	Fast Green Blinking	Sensitivity is too low. Dirty detection window. Sensor failure.	Set the sensitivity higher.(*) Wipe the detection window with a damp cloth. Do not use any cleaner or solvent. Contact your installer or service engineer.
	Slow Green Blinking	Signal saturation. (2nd and/or 3rd row) The detection area overlaps with the door/header.	Remove highly reflecting objects from the detection area. Lower the sensitivity.(*) Change the area depth angle. Adjust the detection area to "Deep" (Outside).
Red & Green Blinking	Setting error.	After changing the dipswitch settings, make sure to push the function switch for 2 seconds.	
Proper operation	Slow Green Blinking	Signal saturation. (4th, 5th, 6th row and/or BLUEZONE)	Remove highly reflecting objects from the detection area. Lower the sensitivity.(*) Change the area depth angle.

\*: After changing the dipswitch settings, make sure to push the function switch for 2 seconds.

## REFERENCE

### Area depth adjustment with INFRARED FINDER (Separately available)

- Turn the depth angle adjustment screw to the right (Deep) to place the detection area most away from the door.
- Set INFRARED FINDER sensitivity to "H" (High) and place it on the floor as shown below.

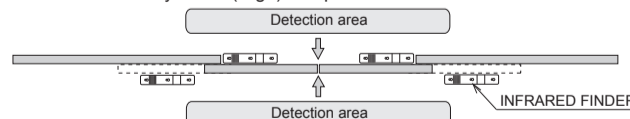

- Turn the depth angle adjustment screw to the left (Shallow) until the emitting area is placed at the position where INFRARED FINDER is in the low detection status (Slow Red Blinking).

### Manufacturer

**OPTEX CO., LTD.**  
5-8-12 Ogoto Otsu 520-0101, Japan  
TEL.: +81(0)77 579 8700 FAX.: +81(0)77 579 7030  
WEBSITE: www.optex.net

### European Subsidiary

**OPTEX Technologies B.V.**  
Henricuskade 17, 2497 NB The Hague, The Netherlands  
TEL.: +31(0)70 419 41 00 FAX.: +31(0)70 317 73 21  
E-MAIL: info@optex.eu WEBSITE: www.optex.eu