

# OA-PRESENCE T

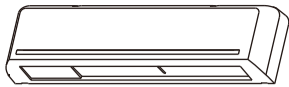

5914603 MAR 2013

TM-0031-8

## MANUFACTURER'S STATEMENT

Read this operation manual carefully before use to ensure proper operation of the sensor. Failure to read this operation manual may cause improper sensor operation and may result in serious injury or death of person. The meanings of the symbols are as follows. Please study the following first and then read the contents of this operation manual.

	<b>WARNING</b>	Disregard of warning may cause the improper operation causing death or serious injury of person.
	<b>CAUTION</b>	Disregard of caution may cause the improper operation causing injury of person or damage to objects.
	<b>NOTE</b>	Special attention is required to the section of this symbol.
		It is required to check the operation manual if this symbol is shown on the product.

### NOTE

- This sensor is a non-contact switch intended for header mount or wall mount of an automatic door. Do not use for any other applications. This sensor cannot be used for industrial doors or shutters, when used, proper operation and safety cannot be guaranteed.
- When setting the sensor's detection area, make sure there is no traffic around the installation site.
- Before turning the power ON, check the wiring to prevent damage or malfunction of equipments that are connected to the sensor.
- Only use the sensor as specified in the operation manual provided.
- Be sure to install the sensor in accordance with the local laws and standards of the country in which the sensor is installed.
- Before leaving the job site make sure that the sensor is operating properly and instruct the building owner/operator on proper operation of the door and the sensor.
- The sensor settings can only be changed by an installer or service engineer. When changed, the changed settings and dates shall be registered in the maintenance logbook accompanying the door.

	<b>WARNING</b>	Do not wash, disassemble, rebuild or repair the sensor, otherwise it may cause electric shock or breakdown of equipments.
<b>Danger of electric shock.</b>		

## SPECIFICATIONS

Model	: OA-PRESENCE T	Test input	: Opto coupler
Cover color	: Black / Silver	Voltage	: 5 to 30VDC
Mounting height	: 2.0 to 3.0m (6'7" to 9'10")	Current	: 6mA Max. (30VDC)
Detection area	: See <b>ADJUSTMENTS</b>	Noise level	: <70dBA
Detection method	: Active Infrared Reflection	Output hold time	: Approx. 0.5sec.
Depth angle adjustment	: -5 to 5°	Response time	: <0.3sec.
Power supply (*)	: 12 to 24VAC (±10%) 12 to 30VDC (±10%)	Operating temperature	: -20 to +55°C (-4 to 131°F)
Power consumption	: < 2W (< 3VA at AC)	Operating humidity	: <80%
Operation LED	: See chart below	IP rate	: IP54
Safety / Test output	: Opto coupler (NPN)	Category	: 2 (EN ISO13849-1 : 2008)
	Voltage / 5 to 50VDC	Performance level	: d (EN ISO13849-1 : 2008)
	Current / 100mA Max.	Weight	: 260g (9.2oz)
	Dark current / 600nA Max.	Accessories	: 1 Operation manual 2 Mounting screws 1 Mounting template 1 Cable 3m(9'10") (6 × 0.14mm <sup>2</sup> AWG26 / Overcurrent protection with less than 2A)
	(Resistance load)		

### Operation LED

Status	Operation LED color
Stand-by	Green
Detection	Red
Wrong dipswitch setting	Red & Green blinking
Signal saturation	Slow Green blinking
Sensor failure	Fast Green blinking

\* When using this sensor, the sensor has to be connected to a door system which has the SELV circuit.

**NOTE** The specifications herein are subject to change without prior notice due to improvements.

## OUTER DIMENSIONS AND PART NAMES

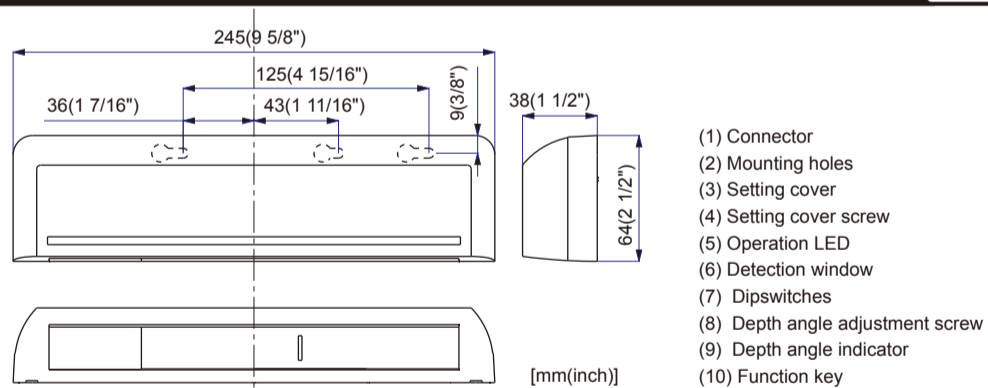

When setting cover is open.

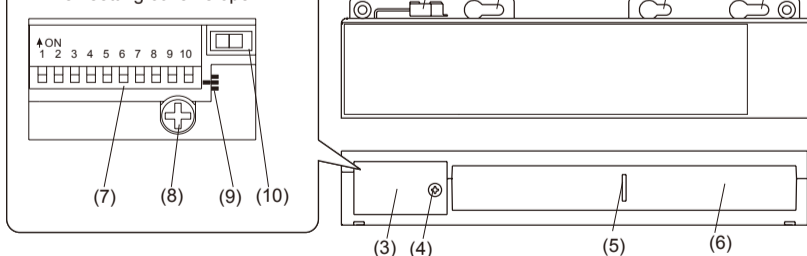

## INSTALLATION

- NOTE** The following conditions are not suitable for the sensor installation.
- Fog or exhaust emission around the door.
  - Wet floor.
  - Vibrating header or mounting surface.
  - Moving objects or a heating radiator in the detection area.
  - Highly reflecting floor or highly reflecting objects around the door.

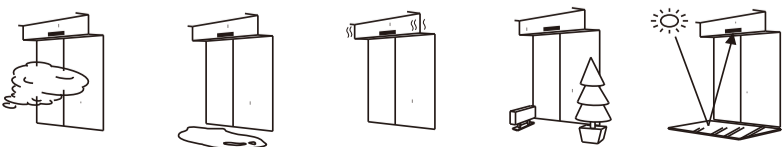

1

- Affix the mounting template at the desired mounting position. (When setting the detection area close to the door, mount the sensor according to the chart below.)
- Drill two mounting holes of  $\phi 3.4\text{mm}$  ( $\phi 1/8"$ ).
- To pass the cable through the header, drill a wiring hole of  $\phi 8\text{mm}$  ( $\phi 5/16"$ ).
- Remove the mounting template.

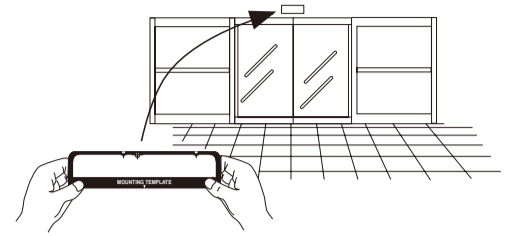
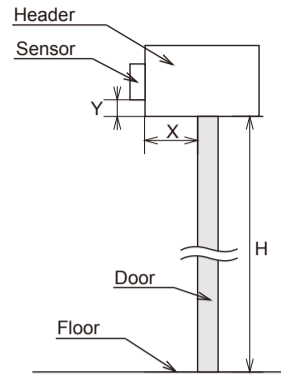

H: Height from the floor to the bottom of the header  
Y: Distance between the bottom of header and the sensor.  
X: Distance between the door and the mounting surface  
(The mounting height is "H + Y".)

Maximum mounting distance (Y)

[mm(feet,inch)]

X \ H	2,000 (6' 6")	2,200 (7' 2")	2,500 (8' 2")	2,930 (9' 9")	3,000 (9'10")
0	No limit				
50 (1 15/16")	45 (1 3/4")	50 (1 15/16")	55 (2 3/16")	70 (2 3/4")	0
100 (3 15/16")	35 (1 3/8")	40 (1 9/16")	45 (1 3/4")	55 (2 3/16")	0
150 (5 7/8")	25 (1")	30 (1 3/16")	35 (1 3/8")	40 (1 9/16")	0
200 (7 7/8")	15 (9/16")	20 (13/16")	25 (1")	35 (1 3/8")	0
250 (9 13/16")	-	15 (9/16")	20 (13/16")	25 (1")	0
300 (11 13/16")	-	-	-	15 (9/16")	0

- Unhook (A) to remove the housing cover as shown below.
- Fix the sensor to the mounting surface with two mounting screws.

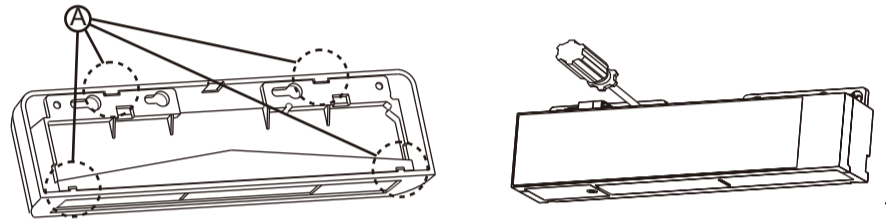

	<b>CAUTION</b>	Make sure to affix the mounting template as described in the above chart, otherwise it can be dangerous since there may be no detection area around the threshold. Install the sensor as low as possible on the header.
<b>Risk of getting caught.</b>		

2

Wire the cable to the door controller as shown below.

To connector of the sensor

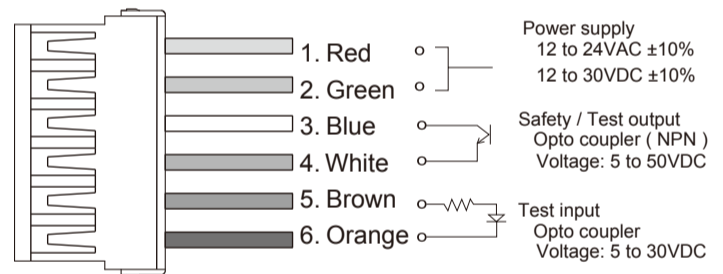

	<b>WARNING</b>	Before starting the procedure, ensure that the power is turned OFF. When passing the cable through the hole, do not tear the shield, otherwise it may cause electric shock or breakdown of the sensor.
<b>Danger of electric shock.</b>		

3

- Plug the connector of the sensor.
- Open the setting cover.
- Supply power to the sensor. Adjust the detection area and set the dipswitches. ( See **ADJUSTMENTS**)
- Close the setting cover.

**NOTE** Make sure to connect the cable correctly to the door controller before turning the power ON. To enable the presence detection, do not enter the detection area for 10 seconds after supplying the power. Do not touch the dipswitches before turning the power ON, otherwise an error occurs. When changing the settings of dipswitches, check **ADJUSTMENTS 3 Dipswitch settings**.

4

Place the housing cover. If wiring is to be exposed, break the knockout.

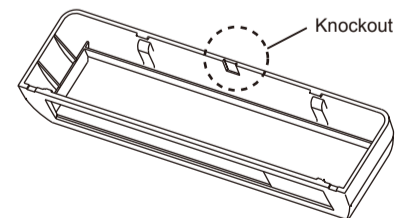

	<b>WARNING</b>	Do not use the sensor without the cover. When using the cable knockout, install the sensor indoors or use the rain-cover (Separately available) otherwise electric shock or breakdown of the sensor may occur.
<b>Danger of electric shock.</b>		

**NOTE** To remove the housing cover of the sensor installed on the header, place a screw driver in the two notches on the upper part of the sensor.

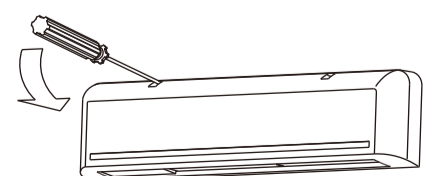

## ADJUSTMENTS

### 1 Detection area according to the test conditions required by EN 16005.

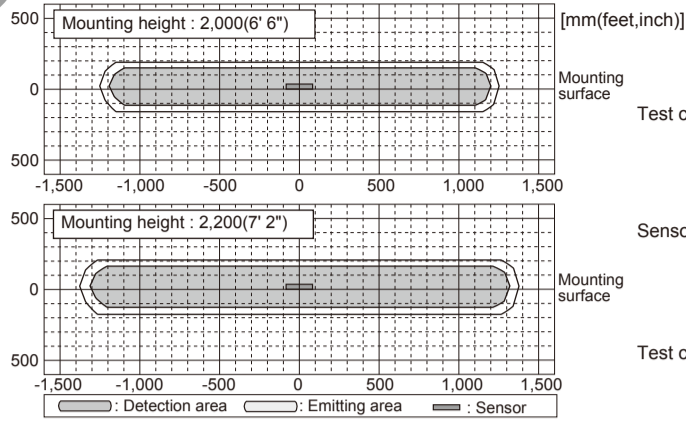

Test conditions required by EN 16005  
 Floor : Grey paper  
 Detection object : EN 16005 CA reference body  
 Sensor setting  
 Area angle : 0°  
 Sensitivity : "Middle"  
 Area width : 8 Spots  
 Test conditions  
 Speed of detection object : 50mm / sec.

**NOTE** The actual detection area may become smaller depending on the ambient light, the color / material of the object or the floor as well as the entry speed of the object. The sensor may not be activated when the entering speed of the object or a person is slower than 50mm / sec. or faster than 1,500mm / sec.

### 2 Area depth angle adjustment

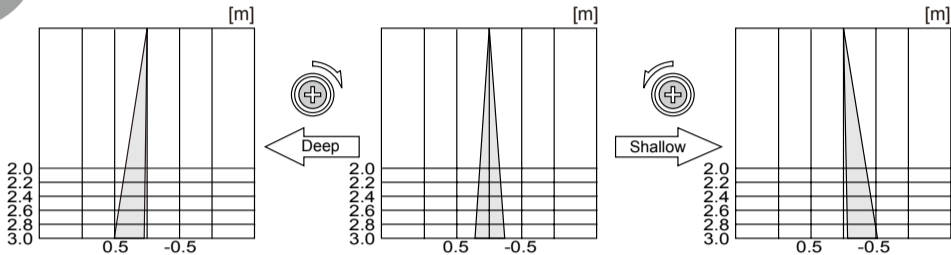

The detection area can be adjusted up to 5° away from the door (Deep) or 5° towards the door (Shallow). Adjust the required detection area by turning the depth adjustment screw with a screw driver. Check the detection area position with Red LED of the Operation LED using a tool such as a reflecting mirror. For the compliance with EN 16005, the required fine adjustments applying the EN 16005 test conditions are recommended.

**NOTE** Make sure the detection area does not overlap with the door / header, otherwise ghosting / signal saturation may occur. Do not place any highly reflecting objects in the detection area, otherwise signal saturation may occur.

### REFERENCE Area depth adjustment with INFRARED FINDER (Separately available)

- Turn the depth adjustment screw to the right (Deep) to place the detection area most away from the door.
- Set INFRARED FINDER sensitivity to "H" (High) and place it on the floor as shown below.

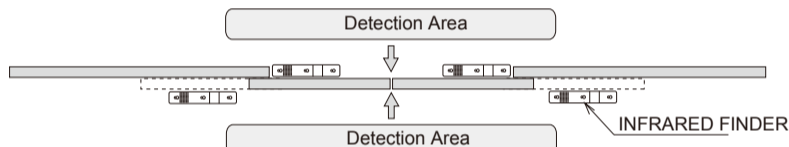

- Turn the depth adjustment screw to the left (Shallow) until the emitting area is placed at the position where INFRARED FINDER is in the low detection status (Slow Red blinking).

### 3 Dipswitch settings

Follow these steps to change the settings of dipswitches.

- Change the function key from "Operation Mode" to "Setting Mode".
- Change the dipswitches setting.
- Change the function key back to "Operation Mode".

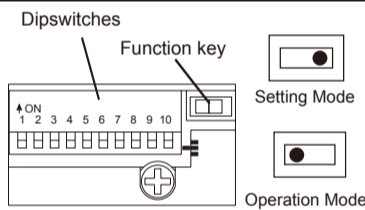

**NOTE** When the above procedures (1-3) are not followed, an error (Red & Green blinking) occurs. Make sure to use the sensor only in "Operation Mode". The sensor does not operate properly in "Setting Mode".

#### 3-1. Setting the sensitivity

Normally set to "Middle". "Low" decreases the sensitivity and "High / S-High" increases the sensitivity. Refer to the chart below for the suitable sensitivity to each installation environment.

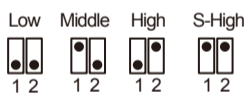

Floor condition	Mounting height [ mm (feet,inch) ]					For example
	2,000 (6' 6")	2,200 (7' 2")	2,500 (8' 2")	3,000 (9' 10")		
Low reflection	Middle	Middle	High	S-High		-Carpet -Dark color floor
Middle reflection	Low	Middle	Middle	S-High		-Concrete
High reflection	Low	Low	Middle	High		-Tile -Marble

**NOTE** Special attention to the setting is required when the door is used often by the elderly or children. Please adjust the sensitivity and presence detection timer according to your risk assessment.

#### 3-2. Setting the presence detection timer

The presence detection timer can be selected from 4 settings. To comply with EN 16005, set the timer "30sec." or longer.



**NOTE** To enable the presence detection, do not enter the detection area for 10 seconds after setting the timer.

#### 3-3. Setting the area width

The left and right width can be adjusted by combining dipswitches 5, 6, 7 and 8. Referring to the chart below, select dipswitches 5 and 6 for the left and dipswitches 7 and 8 for the right area width adjustment.

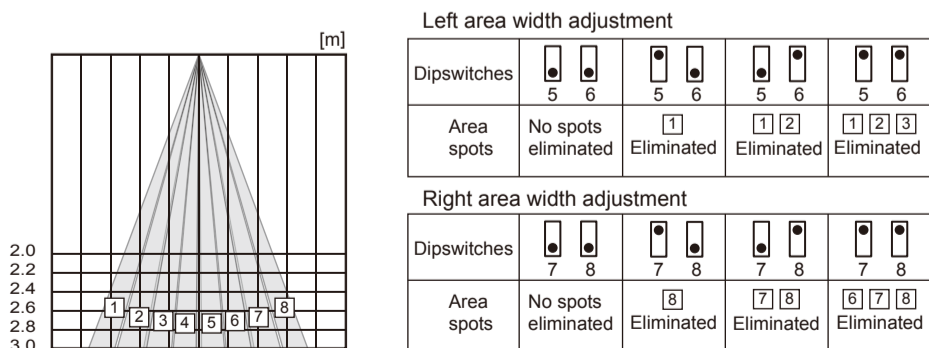

**NOTE** The actual detection area may become smaller depending on the ambient light, the color / material of the object or the floor as well as the entry speed of the object. The sensor may not be activated when the entering speed of an object or a person is slower than 50mm / sec. or faster than 1,500mm / sec.

#### 3-4. Setting the frequency

When using more than two sensors close to each other, set the different frequency for each sensor by dipswitch 9.

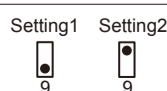

### 3-5. Setting the test input

Set dipswitch 10 according to the test input from the door controller.

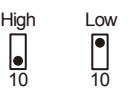

< Test input and Safety / Test output timing chart >

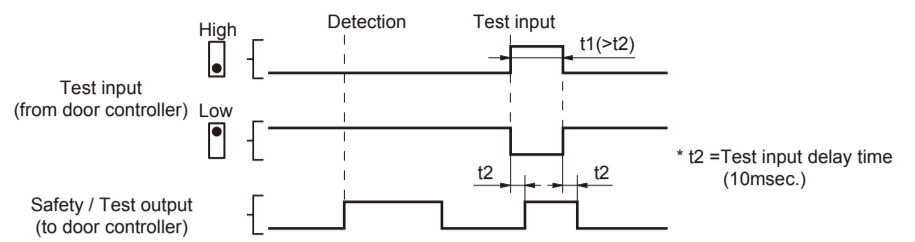

\*The test input delay time is the time period between the test input and safety / test output.

## CHECKING

Check the operation according to the chart below.

	Power OFF	Outside of detection area	Entry into detection area	Outside of detection area
Entry				
Status	-	Stand-by	Motion/Presence detection active	Stand-by
Operation LED	None	Green	Red	Green
Output	OFF	ON	OFF	ON

## COMPLIED STANDARDS

EN 16005:2012 EN 12978+A1:2009 Machinery Directive 2006/42/EC  
 EMC Directive 2004/108/EC EN ISO 13849-1:2008 EN ISO 13849-2:2008  
 EN 61496-3:2001 clause 4. 3. 5 and 5. 4. 7. 3  
 Notified Body: TÜV SÜD Product Service GmbH, Daimlerstraße 40 60314 Frankfurt Germany

## INFORM BUILDING OWNER / OPERATOR OF THE FOLLOWING ITEMS

### WARNING

- Always keep the detection window clean. If dirty, wipe the window lightly with a damp cloth. (Do not use any cleaner or solvent.)
- Do not wash the sensor with water.
- Do not disassemble, rebuild or repair the sensor yourself, otherwise electric shock may occur.
- When an operation LED blinks green, contact your installer or service engineer.
- Always contact your installer or service engineer when changing the settings.
- Do not paint the detection window.

### NOTE

- When turning the power ON, always walk-test the detection area to ensure proper operation.
- Do not place any objects that move or emit light in the detection area. (e.g. Plant, illumination, etc.)

## TROUBLESHOOTING

Problem	Operation LED	Possible cause	Possible countermeasures
Door does not open when a person enters the detection area.	None	Power supply voltage. Wrong wiring or connection failure.	Set to the stated voltage. Check the wires and connector.
	Unstable	Wrong detection area positioning.	Check <b>ADJUSTMENTS 1, 2 &amp; 3</b> (*).
		Sensitivity is too low.	Set the sensitivity higher(*).
		Short presence detection timer.	Set the presence detection timer longer(*).
Door opens when no one is in the detection area. (Ghosting)	Unstable	Dirty detection window.	Wipe the detection window with a damp cloth. (Do not use any cleaner or solvent.)
		Vibration of the header.	Set the sensitivity lower.
		Water drops on the detection window.	Use the rain-cover (Separately available). Or install in a place keeping the waterdrops off.
		The detection area overlaps with that of another sensor.	Check <b>ADJUSTMENTS 3-4</b> (*).
		The detection area overlaps with the door / header.	Adjust the detection area to "Deep" (Outside).
	Proper	Reflecting objects in the detection area. Or reflecting light on the floor.	Remove the objects.
		Sensitivity is too high.	Set the sensitivity lower(*).
		Objects that move or emit light in the detection area. (Ex.Plant, illumination, etc.)	Remove the objects.
		Wet floor.	Check the installation condition referring to <b>INSTALLATION</b> on the reverse side.
		The exhaust emission or fog penetrate into the detection area.	
Door remains open	Red	Sudden change in the detection area.	Check <b>ADJUSTMENTS 3-1 &amp; 3-2</b> (*). If the problem still persists, hard-reset the sensor.(Turn the power OFF and ON again.)
	Proper	Wrong wiring or connection failure.	Check the wires and connector.
		Wrong setting of dipswitches.	Check <b>ADJUSTMENTS 3-5</b> (*).
		Wrong setting of function key.	Set to "Operation Mode".
	Fast Green blinking	Sensor failure.	Contact your installer or service engineer.
		Dirty detection window.	Wipe the detection window with a damp cloth. (Do not use any cleaner or solvent.)
	Slow Green blinking	Sensitivity is too low.	Set the sensitivity higher(*).
Signal saturation.		Remove highly reflecting objects from the detection area. Or lower the sensitivity. Or change the area angle.	
Red & Green blinking	The detection area overlaps with the door / header.	Adjust the detection area to "Deep" (Outside).	
	Wrong setting of dipswitches.	1. Set the function key to "Setting Mode" 2. Change dipswitch 10 setting (ON→OFF→ON or OFF→ON→OFF) 3. Set the function key back to "Operation Mode".	
Door remains closed	Proper	Wrong wiring or connection failure.	Check the wires and connector.

\* Before changing these settings, set the function key to the "Setting mode". When finished, set back to the "Operation mode".

### Manufacturer

**OPTEX Co.,LTD.**  
 5-8-12 Ogoto Otsu 520-0101, Japan  
 TEL.: +81(0)77 579 8700 FAX.: +81(0)77 579 7030  
 WEBSITE: www.optex.co.jp

### European Subsidiary

**OPTEX Technologies B.V.**  
 Tiber 2, 2491 DH The Hague, The Netherlands  
 TEL.: +31(0)70 419 41 00 FAX.: +31(0)70 317 73 21  
 E-MAIL: info@optex.nl WEBSITE: www.optex.nl

### North and South American Subsidiary

**OPTEX Technologies Inc.**  
**Corporate Headquarters**  
 3882 Del Amo Blvd., Suite 604 Torrance, CA 90503 U.S.A.  
 TOLL-FREE: 800 877 6656 FAX.: +1 310 214 8655  
 WEBSITE: www.optextechnologies.com

### East Coast Office

8510 McAlpines Park Drive, Suite 108 Charlotte, NC 28211 U.S.A.  
 TOLL-FREE: 800 877 6656 FAX.: +1 704 365 0818  
 WEBSITE: www.optextechnologies.com