

Manufacturer's statement

Read this operation manual carefully before use to ensure proper operation of this product. Failure to read this operation manual may cause improper operation and may result in serious injury or death of a person. The meanings of the symbols are as follows.

WARNING Failure to follow the instructions that accompany this indication and improper handling may result in serious injury or death.

CAUTION Failure to follow the instructions that accompany this indication and improper handling may result in injury and/or damage to property.

NOTE Pay special attention to sections with this symbol.

NOTE It is required to check the operation manual if this symbol is shown on the product.

- NOTE**
- This product is a non-contact switch intended for header mount or wall mount for use on an automatic sliding door. Do not use for any other applications.
 - When setting the sensor's detection area, make sure that there is no traffic around the installation site.
 - Before turning the power ON, check the wiring to prevent damage or malfunction of equipment connected to the product.
 - Only use the product as specified in the operation manual provided.
 - Be sure to install and adjust the sensor in accordance with the local laws and standards of the country in which the product is installed.
 - Before leaving the installation site make sure that the product is operating properly and instruct the building owner/operator on proper operation of the door and the product.
 - The product settings can only be changed by an installer or service engineer. When changed, the changed settings and the date shall be registered in the maintenance logbook accompanying the door.

The following conditions are not suitable for sensor installation.

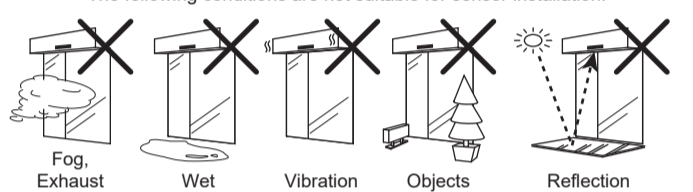

WARNING
Danger of electric shock
Do not wash, disassemble, rebuild or repair the sensor, otherwise it may cause electric shock or breakdown of the equipment.

Specifications

Model	: OAM-DUAL T	Activation output	: Form A relay 50 V 0.3 A Max.
Cover color	: Black	Safety output	: Form A relay 50 V 0.3 A Max.
Mounting height	: 2.0 to 3.5 m (6'7" to 11'6")	Test input	: Opto coupler
Detection area	: See Detection area		Voltage 5 to 30 VDC
Detection method	: Active infrared reflection (*1)		Current 6 mA Max. (30 VDC)
	Microwave Doppler effect	IP rate	: IP54
Transmitter frequency	: 24.125 GHz	Category	: See Table 1
Transmitter radiated power	: < 20 dBm	Performance level	: See Table 1
Depth angle adjustment	: AIR area -6 to +6°	ESPE	: Type 2
	Radar area +25 to +45°	Weight	: 270 g (9.5 oz)
Power supply (*2)	: 12 to 24 VAC ±10 % (50/60 Hz)	Accessories	: 1 Operation manual
	12 to 30 VDC ±10 %		2 Mounting screws
Power consumption	: < 2.5 W (< 4 VA at AC)		1 Mounting template
Operation indicator	: See Operation indicator table		1 Area adjustment tool
Output hold time	: < 500 ms		1 Cable 3 m (9'10")(*3)
Response time	: < 300 ms		
Operating temperature	: -20 to +55°C (-4 to 131°F)		
Operating humidity	: < 80 % (non-condensing)		
Noise level	: < 70 dBA		

Table 1

AIR part	Cat.	2 (EN ISO13849-1:2015)
	PL	d (EN ISO13849-1:2015)

Operation indicator table

Status	Operation indicator color	Timing
Warm-up	Yellow blinking	1000 ms
Stand-by (Installation mode)	Yellow	
Stand-by (Service mode)	Yellow & Green blinking	
Stand-by (Operation mode)	Green	
BLUEZONE (Lookback) detection (*4)	Blue	
2nd row detection	Red blinking	
3rd row detection	Red	
Radar detection	Orange	
Communication Test output	Turn off 500 ms (*5)	
Setting error	Red & Green blinking	
Signal saturation	Slow Green blinking	
Sensitivity too low(or Sensor failure)	Fast Green blinking	

NOTE The specifications herein are subject to change without prior notice due to improvements.
*1 : Active infrared reflection has a presence detection function.
*2 : The sensor has to be connected to a door system which has a SELV circuit.
*3 : Overcurrent protection with less than 2 A.
*4 : See **BLUEZONE (Lookback) area**
*5 : LED will be turned off approx. 500 ms when the sensor Test output signal works well.

BLUEZONE (Lookback) area

When dipswitch 15 is set to "ON", the BLUEZONE (Lookback) area, that provides extra safety over the threshold is activated. In case the BLUEZONE (Lookback) function is not required, set dipswitch 15 to "OFF". Do not set the 2nd row overlapping the threshold regardless of the setting of dipswitch 15.

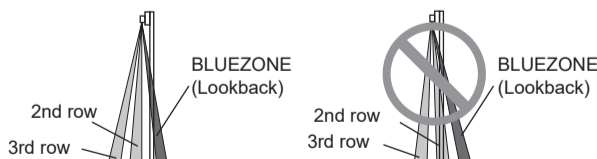

Outer dimensions and part names

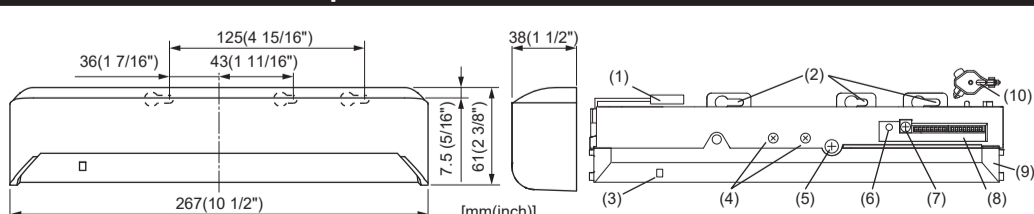

- (1) Connector
- (2) Mounting holes
- (3) Operation indicator
- (4) Width adjustment screws
- (5) Depth angle adjustment screw
- (6) Function switch
- (7) Radar sensitivity potentiometer
- (8) Dipswitches
- (9) Detection window
- (10) Area adjustment tool

Detection area

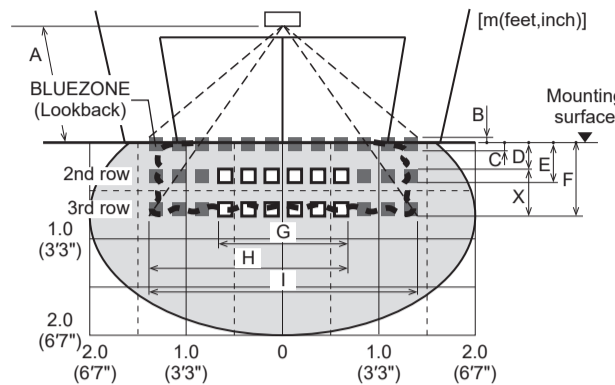

AIR
Mounting height : 2.2 m (7'3")
Angle adjustment : +6°
Sensitivity : Middle
□ : Emitting spots
■ : Emitting spots (can be eliminated)
▨ : Detection area

Radar
Mounting height : 2.2 m (7'3")
Vertical adjustment : +35°
Sensitivity : High
Area width : Wide
Speed of detection object : 50 mm/s
○ : Detection area

AIR emitting area

The chart shows the values at depth angle +6°.

	[m(feet,inch)]					
A	2.00 (6'7")	2.20 (7'3")	2.50 (8'2")	2.70 (8'10")	3.00 (9'10")	3.50 (11'6")
B	0.05 (2")	0.06 (2")	0.07 (3")	0.07 (3")	0.08 (3")	0.09 (4")
C	0.07 (3")	0.08 (3")	0.09 (4")	0.10 (4")	0.11 (4")	0.12 (5")
D	0.23 (9")	0.25 (10")	0.28 (11")	0.31 (1')	0.34 (1'1")	0.39 (1'3")
E	0.35 (1'2")	0.39 (1'3")	0.44 (1'5")	0.48 (1'7")	0.53 (1'9")	0.61 (2')
F	0.59 (1'11")	0.65 (2'2")	0.74 (2'5")	0.80 (2'7")	0.89 (2'11")	1.03 (3'5")
G	1.21 (3'12")	1.33 (4'4")	1.51 (4'11")	1.63 (5'4")	1.81 (5'11")	2.11 (6'11")
H	1.86 (6'1")	2.05 (6'9")	2.32 (7'7")	2.51 (8'3")	2.79 (9'2")	3.25 (10'8")
I	2.52 (8'3")	2.78 (9'1")	3.15 (10'4")	3.40 (11'2")	3.79 (12'5")	4.42 (14'6")

AIR detection area

To comply with EN 16005, make sure that the detection area is within the values of the chart below.

	[m(feet,inch)]		
A	2.00 (6'7")	2.20 (7'3")	3.00 (9'10")
X	0.23 (9")	0.25 (10")	0.34 (1'1")
G	1.02 (3'4")	1.12 (3'8")	1.53 (5')
I*	2.41 (7'11")	2.65 (8'8")	3.60 (11'10")

Test conditions required by EN 16005
Floor : Grey paper
Detection object : EN 16005 CA reference body
Sensitivity : Middle
Speed of detection object : 50 mm/s

The values above are those of the **AIR detection area** when tested referring to the test conditions of EN 16005. (The emitting area is as shown in **AIR emitting area** above.)

* When installed at higher than 3.0 m (9'10"), EN 16005 requirements are fulfilled only within the area width "I" of 3.6 m (11'10").

NOTE The actual detection area may become smaller depending on the ambient light, the color/material of the object or the floor as well as the entry speed of the object. The sensor may not be activated when the entering speed of the object or a person is slower than 50 mm/s or faster than 1500 mm/s.

Installation

1. Mounting

- Place the mounting template at the desired mounting position. (When setting the detection area close to the door, mount the sensor according to the chart below.)
- Drill two mounting holes of $\phi 3.4$ mm ($\phi 1/8"$).
- To pass the cable through the header, drill a wiring hole of $\phi 8$ mm ($\phi 5/16"$).
- Remove the mounting template.
- Remove the housing cover. Fix the sensor to the mounting surface with the two mounting screws.

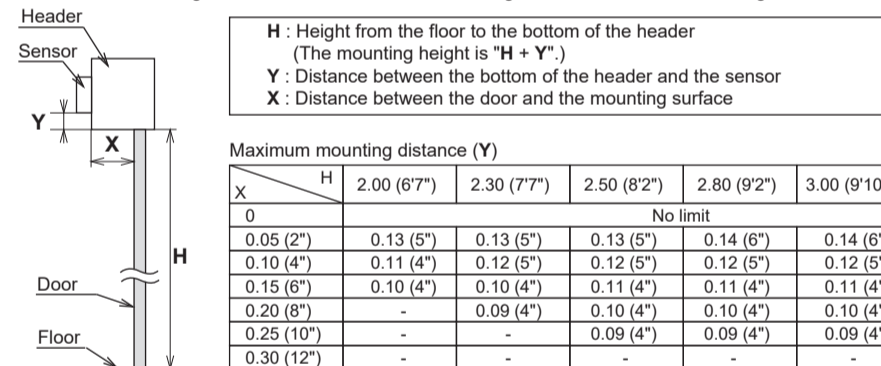

NOTE Make sure not to mount the sensor lower than the bottom of header.

CAUTION Risk of getting caught

Make sure to affix the mounting template as described in the above chart, otherwise it can be dangerous since there may be no detection area around the threshold. Install the sensor as low as possible on the header.

2. Wiring

Wire the cable to the door controller.
* Cable 9 and 10 are not used.

WARNING
Danger of electric shock
Before starting the procedure, make sure that the power is turned OFF. When passing the cable through the hole, do not tear the shield otherwise it may cause electric shock or breakdown of the sensor.

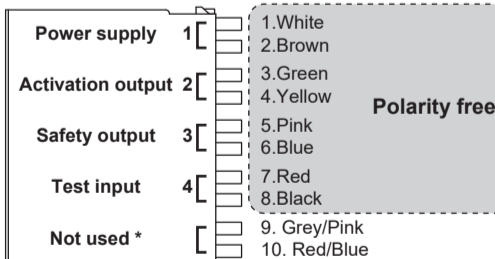

1	12 to 24 VAC ±10 % / 12 to 30 VDC ±10 %
2	Form A relay 50 V 0.3 A Max.
3	Form A relay 50 V 0.3 A Max.
4	Opto coupler / Voltage: 5 to 30 VDC

3. Turn ON the power

- Plug the connector.
- Supply power to the sensor. Adjust the detection area and set the dipswitches. (See **Adjustments 4. Dipswitch settings**)

NOTE Make sure to connect the cable correctly to the door controller before turning the power ON. When turning the power ON or after adjusting the settings, do not enter the detection area for more than 10 s in order to enable the presence detection. Do not touch the dipswitches before turning the power ON, otherwise an error occurs. After changing the dipswitch and/or potentiometer settings, make sure to push the function switch for 2 s.

4. Mounting the housing cover

Place the housing cover. If wiring is to be exposed, break the knockout.

WARNING **Danger of electric shock**
Do not use the sensor without the cover. When using the cable knockout, install the sensor indoors or use the rain cover (Separately available) otherwise electric shock or breakdown of the sensor may occur.

Adjustments

1. Area depth angle adjustment

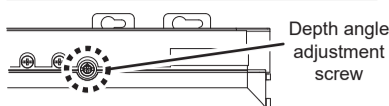

When adjusting the 2nd row close to the door, see **Table 2** dipswitch 16 for the easier adjustment.

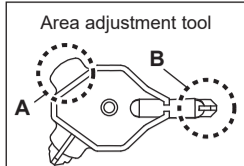

NOTE

Make sure that the detection area does not overlap with the door/header, and there is no highly reflecting object near the detection area otherwise ghosting/signal saturation may occur.

a. AIR adjustment

Depth angle adjustment screw for the AIR area.

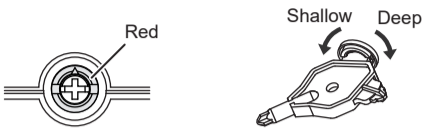

Use the area adjustment tool (A) as shown above to change the area depth angle. For the easier adjustment, see **Reference**. (Separate sheet)

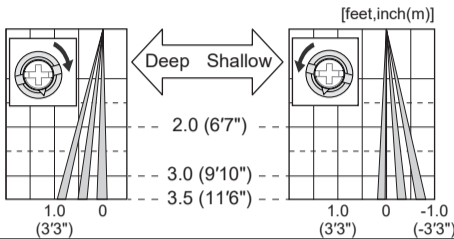

b. Radar adjustment

Depth angle adjustment screw for the Radar area.



Use the area adjustment tool (B) as shown above to change the area depth angle.

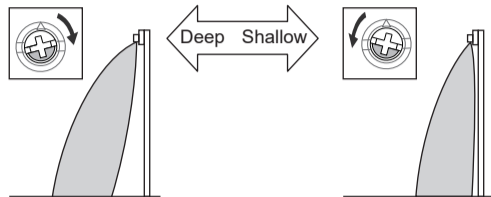

2. Area width adjustment

a. AIR adjustment

To adjust the AIR detection area width, use the adjustment screws as shown in the picture below.

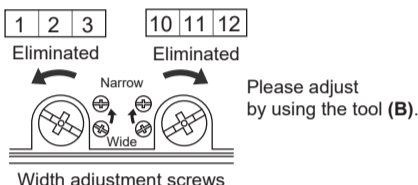

Width adjustment screws

b. Radar adjustment

To adjust the Radar detection area width, use the narrow lens as shown in the picture below.

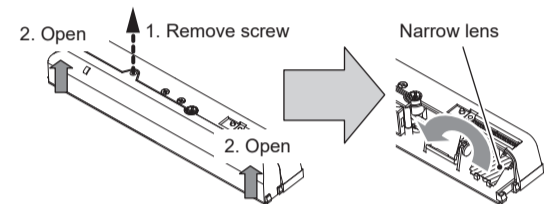

NOTE

When setting the detection area width, make sure to turn the adjustment screws until it clicks. [1][2][3] cannot be eliminated separately, neither can [10][11][12].

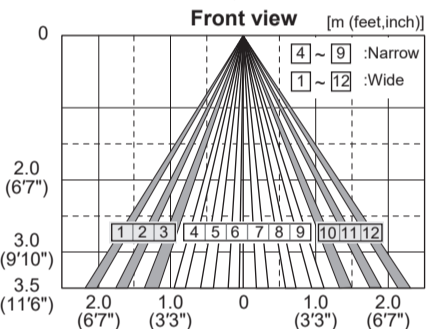

3. Radar sensitivity

Adjust the Radar detection area with potentiometer. Afterwards, make sure to push the function switch for 2 s.

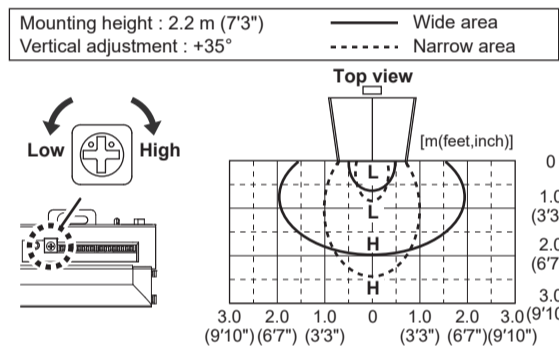

4. Dipswitch settings

After changing the dipswitch settings, make sure to push the function switch for 2 s.

Table 2 ■ AIR settings ■ Radar settings □ Other setting □ Factory default settings

Dip switch No.	Function	Setting				Comment
		Low	Middle	High	S-High	
1	Sensitivity	Low 1 2	Middle 1 2	High 1 2	S-High 1 2	Set the sensitivity according to the mounting height. Values below dipswitches are reference only. Adjust the sensitivity according to your risk assessment.
2		2.0 to 3.0 m	2.0 to 3.0 m	2.5 to 3.2 m	3.0 to 3.5 m	
3	Presence timer	30 s 3 4	60 s 3 4	600 s 3 4	2 s (Motion)* 3 4	To enable the presence detection, do not enter the detection area for 10 s after setting the timer.
4						
5	Frequency	Setting1 5 6	Setting2 5 6	Setting3 5 6	Setting4 5 6	When using more than one sensor close to each other, set the frequency different for each sensor.
6						
7	Safety output (to door controller)	N.C. 7	N.O. 7			The delay time between Test input and Safety output is 10 ms.
8	Test input (from door controller)	High 8	Low 8			If not use the Test input, dipswitch 8 set to "High". *
9	Direction	Bi 9	Uni 9			When dipswitch 9 is set to "Uni", this setting enables the door to close faster when a person walks away from the door.
10	Cross traffic cancel	OFF 10	ON 10			Prevent unnecessary door opening from crossing pedestrian. Activation output is active in case of Radar plus AIR detection. After the activation, Safety output is active in case of Radar detection during the specified time or AIR, which also extend it. This time can be selected by Radar sensitivity potentiometer to 0 s or 30 s.
11	Immunity	OFF 11	ON 11			Set dipswitch 11 to "ON" when the sensor operates by itself (Ghosting). When dipswitch 11 is set to "ON" the actual detection area may occur smaller.
12	Radar output	N.O. 12	N.C. 12			Select "N.O."/"N.C." for Radar output.
13	AIR output	Safety 13	Safety + Activation 13			When dipswitch 13 is set to "Safety + Activation", the sensor outputs safety and activation simultaneously.
14	Self monitoring	ON 14	OFF* 14			When the door remains open and the operation indicator shows Fast/Slow Green blinking, refer to Troubleshooting . If the door still remains open, set dipswitch 14 to "OFF".
15	BLUEZONE (Lookback)	OFF 15	ON 15			When dipswitch 15 is set to "ON", the BLUEZONE (Lookback) is active and looks through the threshold.

Dip switch No.	Function	Setting		Comment
16	Installation mode	OFF 16	ON 16	Set dipswitch 16 to "ON" to adjust the 2nd row. During the installation mode only the 2nd row remains active and the operation indicator shows yellow. After setting the row, set dipswitch 16 to "OFF".

* No EN 16005 compliance.

Service mode

- During the "Service mode", only the 2nd row remains transmitting and the operation indicator shows Yellow & Green blinking.
- After installation, be sure to turn to the "Operation mode" because it does not comply with EN 16005.
- The sensor automatically returns to "Operation mode" after 15 min from the transition.

To Service mode	Keep pushing function switch for 5 s until the operation indicator starts to blink after off.
To Operation mode	Keep pushing function switch until the operation indicator goes off.

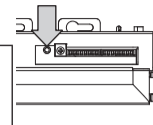

Checking

Check the operation in the operation mode according to the chart below.

Entry	Power OFF	Outside of detection area	Entry into Radar area	Entry into 3rd row	Entry into 2nd row	Entry into BLUEZONE (Lookback)
Status	-	Stand-by	Motion detection	Motion/Presence detection		
Operation indicator	None	Green	Orange	Red	Red blinking	Blue
Activation output	12	N.O.	Safety	13		
				N.C.	Safety + Activation	
Safety output (*1)	7	N.C.	7			
			N.O.	Safety + Activation		

*1 : During warm-up, Safety output is constantly active.

Troubleshooting

Door operation	Operation indicator	Possible cause	Possible countermeasures
Door does not open when a person enters the detection area.	None	Wrong power supply voltage.	Set to the stated voltage.
	Unstable	Wrong wiring or connection failure.	Check the wires and connector.
		Wrong detection area positioning.	Check Adjustments 1, 2, 3 . (*)
		Sensitivity is too low.	Set the sensitivity higher. (*)
		Short presence timer.	Set the presence timer longer. (*)
	Proper	Dirty detection window.	Wipe the detection window with a damp cloth. Do not use any cleaner or solvent.
Door opens when no one is in the detection area. (Ghosting)	Unstable	Wrong wiring or settings.	Check the wires and/or dipswitches.
		Objects that move or emit light in the detection area.	Remove the objects.
	Proper	The detection area overlaps with that of another sensor.	Check Table 2 dipswitch 5, 6. (*)
		Waterdrops on the detection window.	Use the rain-cover. (Separately available) Or wipe the detection window with a damp cloth. Do not use any cleaner or solvent. Or install in a place keeping the waterdrops off.
		The detection area overlaps with the door/header.	Adjust the detection area to "Deep"(Outside). Or set dipswitch 11 to "ON". (*)
		Sensitivity is too high.	Set the sensitivity lower. (*)
		Raining or snowing.	Set dipswitch 9 to "Uni" and/or dipswitch 11 to "ON".(*)
	Yellow	Others	Set dipswitch 11 to "ON". (*)
		Wrong setting of dipswitches.	Check Table 2 dipswitch 7, 8, 12. (*)
		Sudden change in the detection area.	Check Table 2 dipswitch 1 to 4. (*) If the problem still persists, hard-reset the sensor. (Turn the power OFF and ON again)
Door remains open	Fast Green blinking	Wrong wiring or connection failure.	Check the wires and connector.
		Installation mode is set to "ON".	Set dipswitch 16 to "OFF". (*)
	Slow Green blinking	Sensitivity is too low.	Set the sensitivity higher. (*)
		Dirty detection window.	Wipe the detection window with a damp cloth. Do not use any cleaner or solvent.
Red & Green blinking	Sensitivity too low or sensor failure.	Contact your installer or service engineer.	
	Signal saturation.(2nd or 3rd row)	Remove highly reflecting objects from the detection area. Or lower the sensitivity. (*) Or change the area depth angle for AIR area.	
Proper operation	Slow Green blinking	The detection area overlaps with the door/header.	Adjust the detection area to "Deep"(Outside).
		Setting error.	After changing the dipswitch and/or potentiometer settings, make sure to push the function switch for 2 s.
	Yellow & Green blinking	Signal saturation. (BLUEZONE)	Remove highly reflecting objects from the detection area. Or lower the sensitivity. (*) Or change the area depth angle for AIR area.
		Service mode is enabled.	Switch to the Operation mode that keep pushing function switch until the operation indicator goes off.

* After changing the dipswitch and/or potentiometer settings, make sure to push the function switch for 2 s.

Hereby, OPTEX declares that the radio equipment type OAM-DUAL series are in compliance with RED 2014/53/EU. The full text of the EU DoC is available at the following internet address; www.optex.net

Manufacturer

OPTEX CO., LTD.

5-8-12 Ogoto Otsu 520-0101, Japan
TEL.: +81(0)77 579 8700
FAX.: +81(0)77 579 7030
URL www.optex.net

European Subsidiary

OPTEX Technologies B.V.

Henricuskade 17, 2497 NB The Hague,
The Netherlands
TEL.: +31(0)70 419 41 00
FAX.: +31(0)70 317 73 21
E-MAIL: info@optex.eu
URL www.optex.eu

Regional Office DACH

Thaler Berg 11, D-84428 Buchbach
Germany
TEL.: +49(0)8086 947 87 00
URL www.optex.eu