

DPI620G DPI620G-IS

Advanced Modular Calibrator Instruction Manual



DPI620G



DPI620G-IS

Preface

Druck multifunction calibrators are an all-in-one solution for your pressure measurement and generation applications. The DPI620G multifunction process calibrator, which can have HART® / FOUNDATION™ Fieldbus / Profibus® communicator functions, has a modular construction that makes possible future expansion.

Three primary types of calibrator are available:

Genii: DPI620G. Genii Basic: DPI620G-B. Genii Intrinsically Safe: DPI620G-IS.

All types of the Intrinsically Safe (IS) instrument are for use in areas that can have explosive atmospheres. Only use the other types of DPI620G in areas that have non explosive atmospheres.

The calibrator can do many tasks, for example:

- to read and make voltage, current, frequency, and resistance signals
- to make records of data and the automation of calibration procedures
- to test and calibrate electrical equipment, pressure sensors, gauges, switches, thermocouples, RTDs, and other types of equipment.

Safety











WARNING Do not apply pressure greater than the maximum safe working pressure.

It is dangerous to attach an external source of pressure to the PV 62X and the PV624 range of pressure generation stations that use the DPI620G. Use only the internal mechanisms to set and control pressure in the pressure calibrator.

This equipment is safe when you use the procedures in this manual. Do not use this equipment for any other purpose than that specified. This is because the protection given by the equipment can be reduced or canceled.

Symbols

Symbol	Description
	This equipment is compatible with the requirements of all related European safety directives. The equipment has the CE mark.
	This equipment is compatible with the requirements of all related UK Statutory legal standards. The equipment has the UKCA mark.
	This symbol on the equipment, tells the user that they must read the user manual.
	This symbol on the equipment, identifies a warning and that the user must refer to the user manual. Ce symbole, sur l'appareil, est un avertissement qui indique que l'utilisateur doit consulter le manuel d'utilisation.
	USB ports: Type A; Mini Type B connector.
	Ground (Earth)
	DC adapter polarity: the center of the plug is negative.
	Druck is an active member of Europe's Waste Electrical and Electronic Equipment (WEEE) take-back program (directive 2012/19/EU). This equipment that you have bought has used natural resources in its production. Possibly it can have hazardous substances that can have a bad effect on health and the environment. To stop the return of these dangerous substances into our environment and to reduce the demand for natural resources, we encourage you to use the correct take-back systems. Those systems will reuse or recycle most of the materials of your discarded equipment. The crossed-out wheeled bin symbol shows that this instrument is to be discarded safely. Please write to your local or regional waste administration if you need more information on the collection, reuse, and recycling systems. Please use the link below for take-back instructions and more information about this scheme.



<https://qrco.de/dsweee>

Abbreviations

The following abbreviations are used in this manual. Abbreviations are the same in the singular and plural.

Abbreviation	Description
a	Absolute
ac	Alternating Current
avg	Average
CH	Channel
CJ	Cold Junction
COSHH	Control of Substances Hazardous to Health
dc	Direct current
DD	Device Description
DPI	Digital Pressure Instrument
DUT	Device Under Test
etc.	And so on
e.g.	For example
FF	FOUNDATION™ Fieldbus
FS	Full Scale
ft	Foot
g	Gauge
H ₂ O	Water
Hz	Hertz
IDOS	Intelligent Digital Output Sensor (Druck product)
i.e.	That is
in	Inch
IS	Intrinsically Safe
kg	kilogram
m	Metre
mA	milliampere
max	Maximum
mbar	millibar
min	Minute or minimum
MSDS	Material Safety Data Sheet
NPT	National Pipe Thread
PA	Process Automation
P/N	Part Number
psi	Pounds per square inch
RH	Relative Humidity

Abbreviation	Description
RS-232	Serial communications standard
TC	Thermocouple
USB	Universal Serial Bus
V	Volts
°C	Degrees Celsius
°F	Degrees Fahrenheit

Contents

1.	Overview	1
1.1	Introduction	1
1.2	What is supplied	1
1.3	Optional Items	2
1.3.1	Rack Mounting Panel	2
1.4	How to use this Instruction Manual	3
1.5	General Safety Precautions	4
1.6	The use of the DPI620G-IS	4
1.6.1	Special conditions of use	4
1.7	Software Configuration and Security	5
1.8	Warnings	5
1.9	Electrical Safety	5
1.10	Pressure Warnings	6
1.11	Over-voltage Category	7
1.12	Receipt of the Instrument	7
1.13	How to install the Battery	7
1.13.1	Installation of a new DPI620G Battery	7
1.13.2	Installation of DPI620G-IS Battery Pack	8
1.14	How to charge the Battery	9
1.14.1	How to charge the DPI620G Battery	9
1.14.2	How to charge the DPI620G-IS Battery	9
1.14.3	Battery Charging Times	10
1.15	Power On	10
1.15.1	DPI620G or DPI620G-B	10
1.15.2	DPI620G-IS	11
1.16	Power Off	11
1.17	Maintenance	12
1.17.1	How to clean	12
1.18	How to return the instrument	13
1.18.1	Return Goods/Material Procedure	13
1.18.2	Safety Precautions	13
1.18.3	Important Notice	13
1.18.4	For More Information Contact	13
1.19	Packaging for Storage or Transportation	13
1.20	Environment	13
1.21	4Sight2 Software	13
1.22	Table of DPI620G types	14
2.	Instrument Operation	16
2.1	DPI620G Modes	16
2.2	Dashboard Navigation	16
2.3	HELP	18
2.4	The SETTINGS screen	19
2.4.1	SETTINGS - DEVICE	20
2.4.2	SETTINGS - STATUS	22
2.4.3	SETTINGS - FILES	26
2.4.4	SETTINGS - CONNECTION	28
2.4.5	SETTINGS - ADVANCED Menu	30

3.	Calibrator	34
3.1	Basic Calibrator Operation	34
3.1.1	Layout	34
3.1.2	Calibrator Screen Information	36
3.2	Error Indications	36
3.3	TASK MENU	37
3.3.1	PRESSURE TASKS	37
3.3.2	ELECTRICAL TASKS	38
3.3.3	SAVE TASK	38
3.3.4	FAVOURITES	39
3.3.5	CUSTOM TASK	40
3.4	Channel Function	42
3.4.1	Process	43
3.5	Utility Options	44
3.5.1	Max/Min/Avg	45
3.5.2	Switch Test	46
3.5.3	Relief Valve	46
3.6	Process Options	47
4.	Electrical Tasks	48
4.1	Measure or Source Current	48
4.1.1	DPI620G Measure or Source Current	48
4.1.2	DPI620G-IS Measure or Source Current (CH1)	49
4.1.3	DPI620G-IS Source Current, Internal 15V Loop Power, CH2	49
4.2	Measure DC Voltage	50
4.2.1	DPI620G Measure DC Voltage	50
4.2.2	DPI620G-IS Measure DC Voltage	50
4.2.3	DPI620G-IS Measure DC Volts or DC mV on CH2 (Range $\pm 30V$)	51
4.3	Measure AC Voltage (CH1) – 20V RMS Maximum	52
4.3.1	DPI620G Measure AC Voltage (CH1) – 20V RMS Maximum	52
4.4	Measure AC Voltage (CH1) – 300V RMS Maximum	53
4.4.1	DPI620G Measure AC Voltage (CH1) – 300V RMS Maximum	53
4.5	Source DC Voltage (CH1)	54
4.5.1	DPI620G Source DC Voltage (CH1)	54
4.5.2	DPI620G-IS Source DC Voltage CH1	54
4.6	Measure or Source Current with Loop Power	55
4.6.1	DPI620G Measure or Source Current with Internal Loop Power	55
4.6.2	DPI620G-IS Measure or Source Current (CH2)	56
4.6.3	DPI620G-IS Measure or Source Current with Internal 15V Loop Power, CH2	57
4.6.4	DPI620G-IS Measure Current, Internal 15V Loop Power, CH2	57
4.7	Measure Frequency on CH1	58
4.7.1	DPI620G Measure Frequency on CH1	58
4.7.2	DPI620G-IS Measure Frequency Signals on CH1	59
4.8	Source Frequency on CH1	60
4.8.1	DPI620G Source Frequency on CH1	60
4.8.2	DPI620G-IS Source Frequency Signals CH1	61
4.9	Measure or Simulate a Resistance Temperature Detector (RTD)	62
4.9.1	DPI620G Measure or Simulate a Resistance Temperature Detector (RTD)	62
4.9.2	DPI620G-IS Measure or Simulate a Resistance Temperature Detector (RTD)	64
4.10	Measure or Simulate a Thermocouple (TC)	66

4.10.1	DPI620G Measure or Simulate a Thermocouple (TC)	66
4.10.2	DPI620G-IS Measure or Simulate a Thermocouple (TC)	67
4.11	Switch Test	69
5.	Pressure Tasks	71
5.1	Introduction	71
5.2	Module Carrier and PM620 / PM620T Pressure Modules	73
5.2.1	Assembly Instructions	74
5.3	Pressure Connections	74
5.4	Measure Pressure – PM620 or PM620T	76
5.5	Measure Pressure – IDOS	77
5.5.1	IDOS Option Instructions	77
5.5.2	IDOS Function Procedures	78
5.6	Measure Pressure – TERPS USB	79
5.6.1	TERPS Option Instructions	79
5.6.2	TERPS Function Procedures	79
5.7	Leak Test	80
5.8	Set the Pressure Module to Zero	81
6.	Temperature Tasks (RTD Interface)	82
6.1	Setup	82
6.2	Utilities	84
6.3	Settings	84
6.4	User Profiles	85
7.	Test Procedures	86
7.1	Downloaded Procedures	86
7.1.1	Sequence to Upload and Download File	86
7.2	Calibration Wizard	87
7.2.1	How to access the Calibration Wizard	87
7.2.2	How to make a procedure	88
7.3	Example Test	94
7.3.1	Select the test procedure.	94
8.	Documenting	99
8.1	Analysis	99
8.1.1	Setup	99
8.1.2	Define Reference Channel	100
8.1.3	Define Input Channel(s)	100
8.1.4	Analysis Function	101
8.2	Data Logging	102
8.2.1	Setup	103
8.2.2	Operation	103
8.2.3	File Review	104
8.2.4	Data Log File Management	106
9.	HART® Operations	109
9.1	HART® Menu Operations	109
9.2	Start-up	109
9.3	HART® Connections	109
9.3.1	Power Supply from the Calibrator	109

9.3.2	External Loop Power	110
9.3.3	Communicator Attached to a Network	111
9.3.4	Use of Test Connections	111
9.4	How to see HART® Primary Variables	112
9.5	HART® Offline	112
9.5.1	Introduction	112
9.5.2	Device Polling	113
9.5.3	Connected Device Configuration	114
9.5.4	Change Device	115
9.5.5	View Device Summary	115
9.5.6	Open Device Configuration	115
9.5.7	Create a New HART Configuration	118
9.5.8	Open a HART® Offline Configuration	120
9.5.9	File Management	120
9.6	HART® Online	121
9.6.1	HART® SDC Application	121
9.6.2	HART® SDC Data Display	123
9.6.3	How to change Device Data Values	124
9.7	Executing HART Methods	125
9.7.1	HART Method Example – Self-Test	126
9.7.2	HART® Method Example – Analog Trim	126
9.8	HART® SDC Application Preferences	128
9.9	HART® Device Connection Failure	128
9.10	HART® Configurations	129
9.10.1	HART® – Uploading the Configuration	129
9.10.2	HART® – Working with Saved Configurations	129
9.10.3	Copy HART® Configuration to USB	129
9.10.4	Delete HART® Configuration	129
9.10.5	Delete All HART Setup Files	129
9.10.6	Import Setup Files from USB Flash Drive	129
9.11	How to connect a DPI620G-IS to HART® compatible devices	130
9.11.1	Active HART Current Loop	130
9.11.2	Transmitter - External Loop Supply with Current Measure	131
9.11.3	Transmitter - Internal Loop Power Supply with Current Measurement	132
9.11.4	Transmitter - Internal Loop Power Supply with Parallel HART® Connection	134
9.11.5	The Measurement of Loop Current with a Parallel HART Connection	136
9.11.6	Transmitter - Test Connection	137
9.11.7	Positioner - Internal Loop Power Supply with Current Source	138
9.11.8	Positioner - External Loop Supply with Current Source	139
10.	FOUNDATION™ Fieldbus	140
10.1	Introduction	140
10.2	Start up	140
10.2.1	Start up for the DPI620G	140
10.2.2	Start up for the DPI620G-IS	141
10.3	FOUNDATION™ Fieldbus Toolbar	146
10.4	Scanning for Devices (DPI620G & DPI620 IS)	147
10.5	Context Sensitive Menu	148
10.6	DPI620G-IS Device State	149
10.7	Troubleshooting	150
10.8	Device Focus View	150
10.9	The Navigation Menu Tree	150

10.9.1	Block Header bar	151
10.10	Functional Group View	152
10.10.1	How to show Parameter Help	152
10.10.2	How to refresh Data	153
10.10.3	Editing Values	153
10.10.4	Methods	155
10.11	Fieldbus Function Finder	155
10.12	How to Export Data to the PrimaryDPI620G Application	157
10.13	How to see Exported Variables in the Channel Window	158
10.14	Fieldbus Application – My Block	158
10.15	Application Settings	159
10.15.1	Device Library	159
10.15.2	Options	160
10.15.3	Advanced	160
11.	Profibus® PA	161
11.1	Introduction	161
11.2	Profibus® Configurations	161
11.3	Start-up	161
11.4	Profibus® Connections	162
11.5	Profibus® Application – Connecting to a Network	163
11.6	Profibus® Toolbar	164
11.7	Scanning for Devices	164
11.8	Context Sensitive Menu	167
11.9	Troubleshooting Connection Problems	167
11.10	Profibus® Application – Communication	168
11.10.1	Device Focus View	168
11.10.2	Block Navigation Tree	169
11.10.3	Block Header Bar	170
11.10.4	Folder Variables	171
11.10.5	Displayed Parameter Help	172
11.10.6	How to refresh Data	172
11.10.7	Editing Variables	173
11.11	Profibus® Application – My Block	173
11.12	Profibus® Application – Exporting Variables	174
11.12.1	Viewing Exported Variables in Channel Window	175
11.13	Profibus® Application Settings	175
11.13.1	Device Library	175
11.13.2	Application Options	176
11.13.3	Advanced	176
11.14	Profibus® Function Finder	176
12.	Calibration Procedures	178
12.1	Before you start the calibration	178
12.2	Procedures (CH1/CH2): Current (Measure)	180
12.3	Procedures (CH1/CH2): Current (Source)	181
12.4	Procedures (CH1/CH2): DC mV/Volts (Measure)	183
12.5	Procedures (CH1): DC mV/Volts (Source)	185
12.6	Procedures (CH1): Frequency (Measure or Source)	186
12.6.1	Frequency Calibration (Measure Function)	186
12.6.2	Frequency Calibration (Source Function)	187
12.6.3	Frequency Calibration Check	187

12.7 Procedures (CH1): Frequency Amplitude (Source)	188
12.8 Procedures (CH1): Resistance (Measure)	189
12.9 Procedures (CH1): True Ohms (Measure)	190
12.10 Procedures (CH1): Resistance (Source)	191
12.11 Procedures (CH1): TC mV (Measure or Source)	192
12.12 Procedures (CH1): Cold Junction (TC Method) and CJ (Measure)	193
12.12.1 Cold Junction (TC Method)	193
12.12.2 Cold Junction (Alternative Method)	193
12.13 Procedures (CH1): AC mV/Volts (Measure)	194
12.14 Procedures: Pressure Module	195
12.15 Procedures: TERPS USB	196
12.16 Procedures: RTD-INTERFACE	196
13. General Specification	198
Appendix A. COMPLIANCE STATEMENTS	i
A.1 FCC (USA)	i
A.2 CANADA	ii

1. Overview

1.1 Introduction

The Druck DPI620G is a battery powered instrument for electrical measurements, a source of currents and voltages, and for HART® communications. Two more optional data protocols can be installed in the instrument: FOUNDATION™ Fieldbus and the Profibus® PA. The DPI620G supplies the power and user interface options for all available functions. The display is a touchscreen that can have a maximum of six channel screens in which to show different parameters.

There are three types of the DPI620G instrument: DPI620G, DPI620G-B and the DPI620G-IS. The DPI620G is for general use. The DPI620G-IS (Intrinsically Safe) type is for use in areas that possibly have explosive gases. The DPI620G-B has only one electrical channel and has to attach to another device, for example, a PV62X or PV624 pressure station, to function as a pressure calibrator.

You use the **CALIBRATOR** function in the DPI620G user interface to calibrate and test pressure sensors and to test different types of switch.

The use of a type of MC620G module carrier or PV62X/PV624 pressure station, adds functions to the DPI620G. For information about these pressure stations, refer to manuals (132M9253) for the PV62X and (174M7583) for the PV624.

The DPI620G and DPI620G-B are compatible with the PV624 pressure station but the DPI620G-IS is not.

The Druck DPI620G can have Bluetooth hardware as an option, for use with the PV624 device. Refer to the PV624 documentation for information about how to use the DPI620G user interface with this data protocol.

This version of the manual is applicable to software revisions DK420 V05.00.00 and above.

1.2 What is supplied

These items are supplied with the instrument:



Table 1-1: DPI620G Types

DPI620G	DPI620G-B	DPI620G-IS
Druck DPI620G multifunction calibrator	Druck DPI620G-B multifunction calibrator	Druck DPI620G multifunction calibrator _ Intrinsically Safe
Li-polymer battery	Li-polymer battery	Li-Ion battery pack
Mains Adapter	Mains Adapter	Mains Adapter for battery charger Battery Charger Body
AC Probe		
Set of six test leads	Set of four test leads	Set of six test leads
Stylus	Stylus	Stylus
Quick Start & Safety Manual	Quick Start & Safety Manual	Quick Start & Safety Manual

Chapter 1. Overview

1.3 Optional Items

The parts below are available for use on the Druck DPI620G and DPI620 IS. These parts can only be attached to the applicable type of DPI620G instrument.

Optional Item	Description
	<p>Pressure Module Carrier, MC620G & MC620-IS – this attaches directly to the related DPI620G, to let pressure be applied to the instrument. This module carrier can also attach to the DPI620G-B. The MC620G/MC620-IS module carrier holds pressure sensing modules. This makes a fully integrated pressure instrument when put together with the PM620 / PM620T pressure module.</p>
	<p>Pressure Module, PM620/PM620-IS, PM620T/PM620T IS – this is a module that senses pressure and attaches to the pressure module carrier (MC620G/MC620-IS) or a Pressure Station (PV62X, PV624). There are several pressure ranges available with the PM620 / PM620T pressure modules. (See “Calibration Equipment Specification” on page 178).</p>
	<p>Pressure Station, PV62X & PV62X-IS – if the DPI620G/ MC620-IS attaches to a Pressure Station that has a pressure module, it becomes a fully integrated pressure calibrator.</p>
	<p>Hybrid Pressure Station, PV624 - this becomes a fully integrated pressure calibrator when a DPI620G or DPI620G-B attaches to it. This station uses electrical power from its battery to semi-automate some calibrator functions.</p> <p>The DPI620G-IS cannot operate with this pressure station.</p>

1.3.1 Rack Mounting Panel

A DPI620G can attach to a panel that can go into a rack system. For assembly instructions refer to the instruction leaflet that is supplied with the panel.



Figure 1-1: DPI620G with MC620G Module Carrier and PM620 Pressure Modules



Figure 1-2: PV62X Type Pressure Station & PV624 Hybrid Pressure Station holding a DPI620G Calibrator and PM620 Pressure Module

1.4 How to use this Instruction Manual

This manual gives safety and battery installation information for the Druck DPI620G types of instrument. Make sure that personnel who operate and do maintenance on the equipment are approved for this type of work. Before use of the equipment, read and obey all sections, including all WARNINGS and CAUTIONS given in the 'Safety & Quick Start Guide': K0542 for the DPI620G and 114M5004 for the DPI620G-IS.

1.5 General Safety Precautions

Read and obey all the operator's local health and safety regulations and safe working procedures. These are some safety precautions:

- Use only the approved tools, materials and spares to operate and maintain the equipment.
- Use the equipment only for its given purpose. If the equipment is used for a purpose not given in this manual, it is possible that the protection given by the instrument can be canceled.
- Use all applicable Personal Protective Equipment (PPE).
- Do not use sharp objects on the touch-screen.
- Make sure of absolute cleanliness for the instrument use.
- Important damage can be caused if equipment is contaminated before it connects to this instrument.
- Connect only clean equipment to the instrument. Use an external Dirt Moisture Trap to prevent contamination.
- Some liquid and gas mixtures are dangerous. This includes mixtures that occur because of contamination. Make sure that the equipment is safe to use with the necessary media.
- Do not use tools on the instrument that can make incandescent sparks: this can cause an explosion if used in an area that has explosive gases.
- Read and obey all applicable WARNING and CAUTION signs.
- Make sure that:
 - i. All work areas are clean and clear of unwanted tools, equipment and materials.
 - ii. Make sure that you obey all local health and safety and environmental regulations when you discard unwanted materials.
 - iii. All equipment is serviceable.

1.6 The use of the DPI620G-IS

The DPI620G-IS is for use in areas that possibly have explosive gases or fine dust. The classification for the DPI620G-IS is:

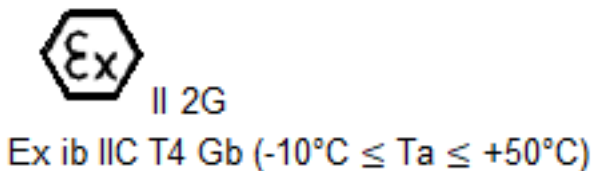

For more information refer to the IS Quick Start and Safety Manual. Use only the Druck battery pack (IO620G-IS-BATTERY).

1.6.1 Special conditions of use

1. The DPI620G-IS USB Client Connection must only be connected to external apparatus within a Safe Area with $U_m = 254V$.
2. When a remote sensor is powered using the Channel 2, 15V, U_o loop supply, the remote sensor must be disconnected from all other sources of power.
3. The Channel 2, V terminals can be connected to a FISCO System if the power for the system is provided from the DPI620G-IS Channel 2, 15V, U_o loop supply and the electrical parameters of the field devices are compatible with those of the DPI620G-IS.

4. The DPI620G-IS should not be connected to a powered FISCO system unless its defined electrical parameters are compatible with the DPI620G-IS.
5. If the Channel 1 Terminals and the Channel 2 Terminals are used together then they must always be connected as separate Intrinsically Safe Circuits.
6. The rechargeable battery pack may be removed from or replaced in a DPI620G-IS within a hazardous area.
7. The rechargeable battery pack must be removed from the DPI620G-IS for recharging in the safe area using only the Socket 3 charging contacts and the Druck charger with $U_m = 254V$. No connections must be made to the IS outputs.
8. Both the MC620-IS Dual Transducer Carrier, or the PV62X-IS Series Pressure Station have a location for either one or two transducers which screw into the pressure connection and the two slip rings on the lower face of a transducer make contact with two spring loaded pins. When either a MC620-IS Dual Transducer Carrier, or the PV62X-IS Series Pressure Station is connected to a DPI620G-IS Advanced Modular Calibrator, these pins are energized and do not meet the requirements of at least IP20. Therefore, it is a requirement of certification that before either the MC620-IS Dual Transducer Carrier or the PV62X-IS Series Pressure Station is connected to the DPI620G-IS Advanced Modular Calibrator, a PM620-IS Transducer or a metallic Dummy Pressure Transducer is screwed into any vacant positions and remains in position until the assembly is removed from the DPI620G-IS Advanced Modular Calibrator.
9. The PV62X-IS Series Pressure Station is for use with the DPI620G-IS.
10. The limit for the lower ambient temperature is $-10^{\circ}C$.

1.7 Software Configuration and Security

Make sure the relevant instrument settings are as expected before use. Other personnel can have made unknown changes to the instrument. Visually inspect the instrument for this type of change before measurements are taken and calibrations done with the instrument,

1.8 Warnings



WARNING Do not ignore the specified limits for the instrument or its related accessories. This can cause injuries.

Do not use this equipment for any other purpose than that specified.

Do not use with media that has an oxygen concentration $> 21\%$ or other strong oxidizing agents. This product contains materials or fluids that may degrade or combust in the presence of strong oxidizing agents. (This restriction of the oxygen concentration also applies to the DPI620G-IS.)

Do not use the instrument in locations with explosive gas, vapor or dust. There is a risk of an explosion. (The DPI620G-IS can be used in an area that has an oxygen concentration of not more than 21% .)

1.9 Electrical Safety



WARNING The DC input to the DPI620G is rated at $5Vdc \pm 5\%$ 4 Amps.

External circuits must have the applicable insulation to the mains supply.

To prevent electrical shocks or damage to the instrument, do not connect more than 30V CAT I between the terminals or between the terminals and the ground (earth).

A chargeable Lithium Polymer (Li-ion) battery supplies power to the DPI620G and DPI620G-B. The DPI620G-IS uses a chargeable Lithium-Ion (Li-Ion) battery pack as its power source. To prevent an explosion or fire do not disassemble or short circuit these batteries.

When the instrument is put in storage for more than 3 months, keep the battery at a minimum charge level of 30% to make battery performance stay constant.

To prevent an explosion or fire, use only the Druck supplied battery, power supply and battery charger.

To prevent battery leakage or heat generation, only use the related battery charger (IS: IO620G-IS-CHARGER) and power supply IO620-PSU in the temperature range 0°C to 40°C (32°C to 104°F).

DPI620G & DPI620G-B: The power supply input range to the optional power supply unit is 100 – 260Vac, 50 to 60 Hz, 250mA, installation category CAT II.

DPI620 IS: The power supply IO620-IS PSU input range is 100 – 240Vac +/-10%, 50 to 60Hz, 250mA, installation category CAT II.

The DC input to the DPI620G-IS battery charger is rated at 5V (+/-5%). Maximum current 2 Amps.

When you use the optional power supply unit, put it in a position so it does not obstruct the supply disconnecting device.

The IS temperature range for operation and storage of the optional PSU (IO620-PSU) is not the same as that for the DPI620G-IS battery charger. The IO620-PSU mains PSU operating temperature range is 0°C to +40°C (32°F to 104°F), storage temperature range -40°C to +70°C (-40°F to 158°F).

Short-term and long-term TEMPORARY OVERVOLTAGES can occur between the line conductor and earth in electrical installations. The equipment will continue to operate when this type of over-voltage occurs.

To make sure the display shows the correct data, disconnect the test leads before power is set to ON or before the selection of a different measure or source function. Keep the leads free from all contaminants.

1.10 Pressure Warnings



WARNING It is dangerous to attach an external source of pressure to a PV 62X or PV624 pressure station. Use only the internal mechanisms to set and control pressure in the pressure calibrator.

To prevent a dangerous release of pressure, isolate and bleed the system before you disconnect a pressure connection.

To prevent a dangerous release of pressure, make sure that all the related pipes, hoses and equipment have the correct pressure rating, are safe to use and are correctly attached.

To prevent damage to the PV62X, PV624, MC620G, PM620 or PM620T, only use the equipment within the specified pressure limits.

Do not exceed the maximum pressures stated in the applicable component manual for the device under test.

Reduce pressure at a controlled rate when you vent the instrument to atmosphere. Carefully release all pressure in pipes to atmospheric pressure before you disconnect or connect to the device under test.

Some liquid and gas mixtures are dangerous. This includes mixtures that occur because of contamination. Make sure that the equipment is safe to use with the necessary media.

Always wear applicable eye protection when you work with pressurized equipment.

1.11 Over-voltage Category

The IEC 61010-1 standard is the source of this summary of installation and measurement over-voltage categories. Each over-voltage category identifies how dangerous an over-voltage transient can be.

Table 1-2: Over-voltage Categories

Over-voltage Category	Description
CAT I	Over-voltage category I has the least dangerous over-voltage transients. Usually CAT I equipment does not directly connect to the mains supply. Examples of CAT I equipment are process loop powered devices.
CAT II	Over-voltage category II is for an electrical installation where typically single phase equipment is connected. Examples of such equipment are appliances and portable tools.

1.12 Receipt of the Instrument

When you receive the instrument, examine the contents in the box listed in Section 1.2. It is recommended to keep the box and packaging for future use.

1.13 How to install the Battery

1.13.1 Installation of a new DPI620G Battery

1. Remove the five Pozidriv screws A, see Figure 1-3.
2. Remove the battery cover (and remove the defective battery if it has to be replaced).
3. Make sure that the connections on the new battery align with the connections in the battery compartment.
4. Put the battery into the battery compartment.
5. Put the battery cover in position.

- Use the five Pozidriv screws to attach the battery cover to the case.

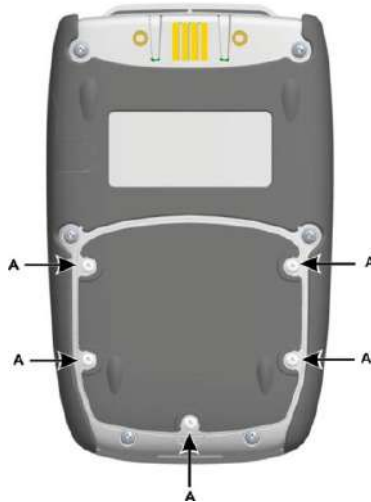

Figure 1-3: Installation of the Battery (Standard)

1.13.2 Installation of DPI620G-IS Battery Pack

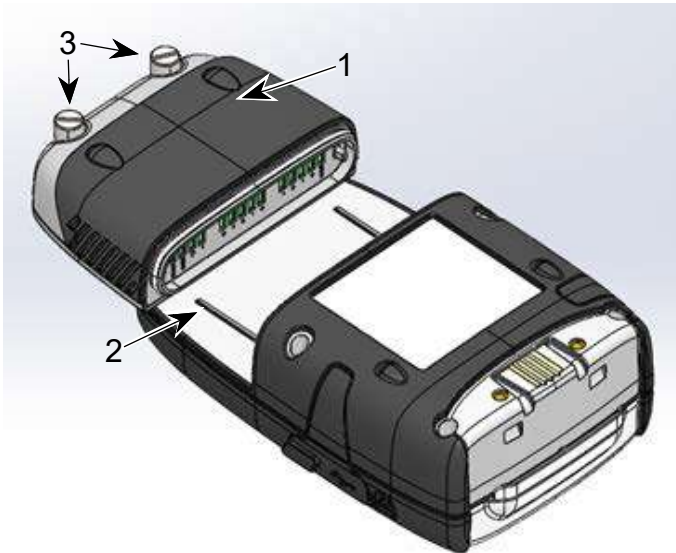

Figure 1-4: Installation of the IS Battery

- Slide the battery fully [1] onto the bottom of the instrument [2] see Figure 1-4.
- Tighten the thumbscrews [3].

1.14 How to charge the Battery

1.14.1 How to charge the DPI620G Battery

1. Push the DC power supply connector into the + 5V DC socket on the side of the unit, see Figure 1-5.
2. The device can accept a charge when it is in operation or de-energized. The time to give a full charge can be longer when the unit is energized or is in standby mode.

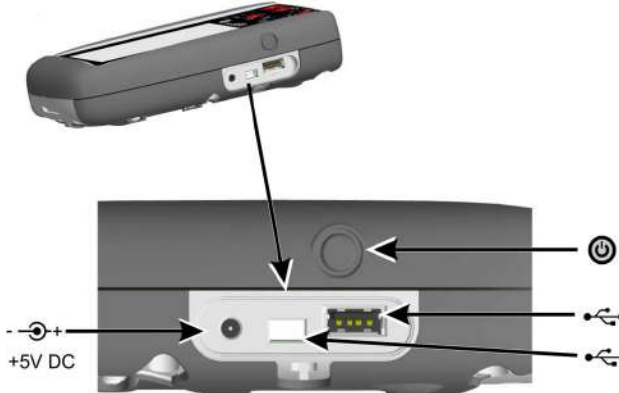

Figure 1-5: DPI620G Power Button and Ports

1.14.2 How to charge the DPI620G-IS Battery

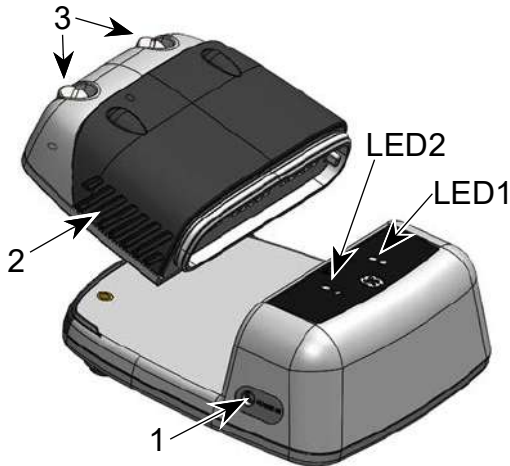

Figure 1-6: DPI620G-IS Battery Pack and Charger

1. Charge the battery in a safe area where there is no possibility of explosive gases.
2. Connect the DC power supply/AC Adapter to the +5V DC connection [1] on the side of the battery charger body.

Chapter 1. Overview

- Put the battery [2] into the charger body at a slight angle, then push and click into place. Tighten the thumb screws [3] to prevent accidental disconnection.
- Switch on the mains power supply. LED1 and LED2 on the charger will show the different operation conditions, as shown in Figure 1-7 below.

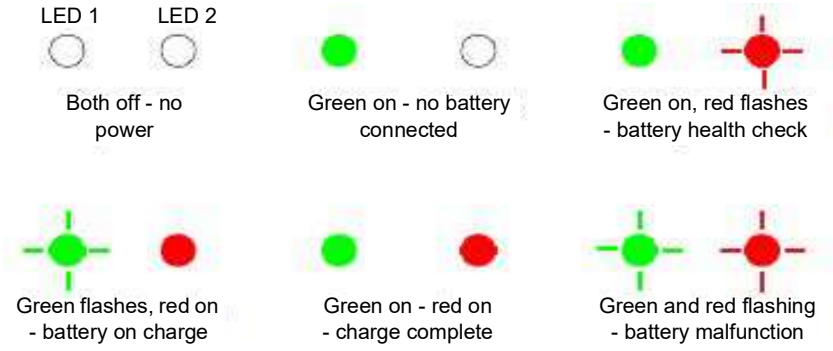

Figure 1-7: Battery Charge & Charger Status

If the charger has a malfunction, disconnect the power supply and connect it again to remove the malfunction. If the malfunction continues contact the Druck Tech Support for instructions.

1.14.3 Battery Charging Times

For DPI620G & DPI620G-B: 6.5 hours for charge by DC Power supply or by the External Battery Charger.

For DPI620G-IS: 8 hours for charge by External Battery Charger.

1.15 Power On

1.15.1 DPI620G or DPI620G-B

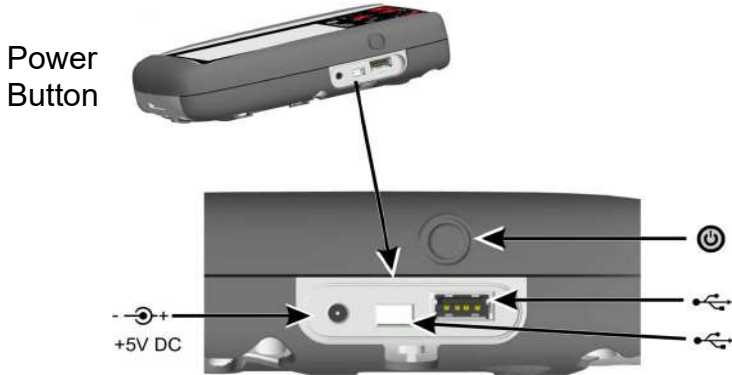

Figure 1-8: DPI620G Power Button and Ports

To energize the instrument when it is de-energized (power is off), push in the power button (power symbol) (Figure 1-8) until the display screen flashes and shows the Druck launch screen. The screen will go blank for a few seconds and then show the Dashboard screen.

It is recommended to leave the battery in the instrument when an external power source is used. The battery will continue to be charged if this is done.

1.15.2 DPI620G-IS

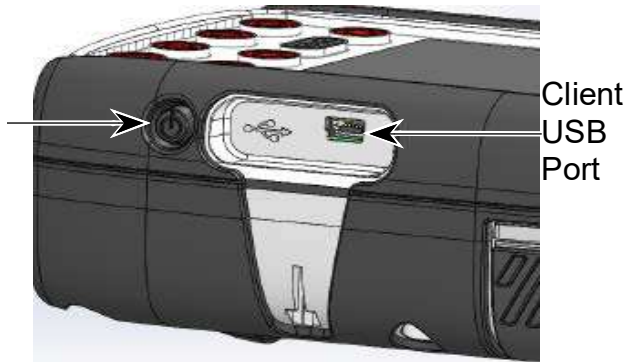



Figure 1-9: DPI620G-IS Power Button and Port

To energize the instrument when it is de-energized (power is off), push the power button  (Figure 1-9) until the display screen flashes and shows the Druck symbol start screen. Release the button. After approximately 25 seconds the display will show the Dashboard screen.

1.16 Power Off

To de-energize (power off) the instrument, push the power button and wait for the screen below, then release the power button. The **POWERDOWN OPTIONS** window appears, as shown in Figure 1-10. Tap one of these menu options.

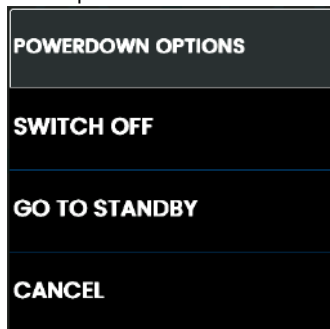

Figure 1-10: POWERDOWN OPTIONS

Option	Description
SWITCH OFF	This starts the full power-down of all types of the DPI620G and is recommended if the device will not operate for several hours. A full reboot will be necessary when it is energized again. To de-energize (do a full power down), push and keep down the power button until the screen goes blank.
GO TO STANDBY	This makes the DPI620G go into standby mode to reduce power consumption. Use the standby mode if the instrument is to be off for short periods. (DPI620G has a fast energize from standby mode). When energized from standby mode, the device always opens the last screen shown before the standby mode was selected.
CANCEL	Cancel the POWERDOWN OPTIONS screen and keep device energized.

1.17 Maintenance

The DPI620G instrument has no user-serviceable parts and you must send it to a Druck service center for repair.

1.17.1 How to clean



CAUTION Do not use solvents or abrasive materials.

Clean the body and display with a lint-free cloth and a weak detergent liquid.

1.18 How to return the instrument

1.18.1 Return Goods/Material Procedure

If it is necessary to calibrate the device or it is not serviceable, send it to the nearest Druck Service Center listed at: <https://grco.de/bcPHml>.

You must get a Return Goods/Material Authorization (RGA or RMA) from the Service Department. Give the following information for a RGA or RMA:

- Product (e.g. DPI620G)
- Serial number
- Information about malfunction/work to be done
- The necessary calibration traceability information
- Operating conditions.

1.18.2 Safety Precautions

Give the following information if applicable: if the product has touched any hazardous or toxic substances, the relevant MSDS and or COSHH references, and the necessary precautions when the device is touched.

1.18.3 Important Notice

Do not use personnel that are not approved for the servicing of this type of device. If personnel are used that are not approved do the servicing, this will affect the warranty and not guarantee future performance.

When you discard used equipment and batteries, obey all the local health and safety procedures.

1.18.4 For More Information Contact

Druck customer service department: www.Druck.com

1.19 Packaging for Storage or Transportation

To put the device into storage or to send the device for calibration or repair, use the following procedures:

1. Put the device into an applicable container that protects against impact damage.
2. To send the device for calibration or repair, complete the Return Goods procedure. See Section 1.18.
3. Send the device to the manufacturer or an approved service agent for all repairs.

1.20 Environment

The following conditions apply for both shipping and storage:

- Temperature Range -20°C to +70°C (-40°F to +158°F)
- Altitude up to 15,000 feet (4,570 meters).

Refer to Chapter 13 on page 198 for more environment conditions.

1.21 4Sight2 Software

4Sight2 gives easy-to-use, cost effective and scalable calibration management with full integration with Druck Calibrators. This gives seamless communication, end-to-end automation, paperless calibration process and increased efficiency.

The 4Sight2 software is available on the Druck website www.druck.com/4sight2 and is free to download and use (trial or Freemium version).

To download test procedures from 4Sight2 on to the DPI620G, connect the instrument to the PC using a USB mini cable. Refer to Section 7.1 on page 86 for more information.

1.22 Table of DPI620G types

The DPI620G is available with different optional hardware. Its type name will show what type of hardware is installed in the instrument. The table below gives all the combinations available.

Table 1-3: Table of available DPI620G types

DPI620G Type	Description
DPI620G-L	Calibrator Lite
DPI620G	Calibrator with HART
DPI620G-FF	Calibrator with HART & Fieldbus
DPI620G-PB	Calibrator with HART & Profibus
DPI620G-FFPB	HART, Fieldbus & Profibus
DPI620G-B	Basic Calibrator
DPI620G-H	Basic Calibrator with HART
DPI620G-L-B1	Calibrator Lite with Bluetooth
DPI620G-B1	Calibrator HART & Bluetooth
DPI620G-FF-B1	Calibrator HART Fieldbus & BLE
DPI620G-FFPB-B1	Calibrator HART Profibus & BLE
DPI620G-B-B1	HART, Fieldbus, Profibus & BLE
DPI620G-H-B1	Basic Calibrator with Bluetooth
DPI620G-IS-L	Basic Calibrator with HART & BLE
DPI620G-IS	IS Calibrator Lite
DPI620G-IS-FF	IS Calibrator with HART
DPI620G-IS-PB	IS Calibrator HART & Fieldbus
DPI620G-IS-FFPB	IS Calibrator HART & Profibus

2. Instrument Operation

This chapter gives examples of how to connect and use the instrument. Read the safety precautions in Section 1.5 and the Quick Start & Safety Manual before you start to read this chapter for the instrument (K0542 - DPI620G & DPI620G-B, 114M5004 - DPI620G-IS).

2.1 DPI620G Modes

These operation modes are available for all types of the DPI620G:

1. CALIBRATOR (with functions in different channels). This includes the following capabilities for each function:
 - a. Data Logging (to record Data when it is made).
 - b. Documentation.
2. HART® Communicator (optional).
3. FOUNDATION™ Fieldbus Communicator (optional).
4. Profibus® Communicator (optional).

2.2 Dashboard Navigation

To use the Dashboard, tap on icons. To select an application or menu choice, tap its related icon or menu button on the Dashboard. The screen below is the Dashboard **HOME** screen that the display shows after launch screen when the DPI620G is energized (powered on).

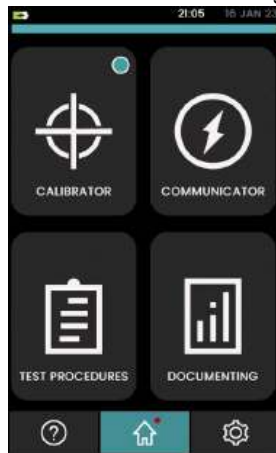





Figure 2-1: Dashboard / Home

The bottom of this screen has three icons: the **Help** icon, the **Home** icon (which in the above example is in green to show that this icon's menus are on the screen) and the **Settings** icon.













Tap the **Help**  icon to show the online Help system for the DPI620G. Refer to “HELP” on page 18 for how to use this screen.

The **Home**  icon shows the first menu screen (Figure 2-1) on the display when the device is first energized (powered on).

Tap the **Settings**  icon to show the **SETTINGS** Home screen that has icons for more sub-menus. Refer to “The SETTINGS screen” on page 19 for information about this screen.

Note: HART®, FOUNDATION™ Fieldbus and Profibus® PA are optional.

Table 2-1: Dashboard Icons

Icon	Function
	Calibrator
	Communicator
	Test Procedures
	Documenting
	Help
	Home.
	Settings
	Blue Status LED (Active)
	Red Status LED (Alarm)
	Green Status LED (Connected)
	FOUNDATION™ Fieldbus
	Profibus®
	HART®

2.3 HELP

Tap the **Help**  icon on the Dashboard to show the **HELP** screen.

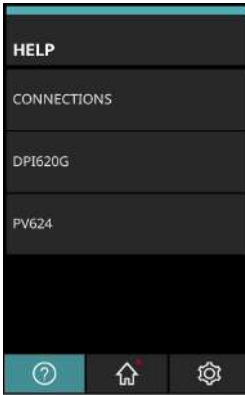

The **DPI620G** and **PV624** menus let a PDF help file be imported into the device storage from a USB memory stick. The user must first copy this help file into the root directory of the memory stick and then attach the memory stick to the device's USB port. Use the **VIEW ONLINE** menu option, as given in the table below, for how to get this Help file.

The file must be named "DPI620G_Manual.pdf" for use by the DPI620G menu or "PV624_Manual.pdf" for use by the PV624 menu. The help file must have the same name for all languages. Use the sub-menu, **IMPORT FROM USB** (described below), to import this Help PDF file.

Help Option	Description
CONNECTIONS	Tap this menu row to show images that give the correct electrical connections for different individual functions. Swipe a finger right or left on the screen to see the different images available. Use the arrow icon in the bottom left of the screen to show the HELP Home screen.
DPI620G	Tap this menu row to show these selections: VIEW ONLINE shows a QR code. Use a mobile phone to scan the code to access the Help system. VIEW DPI620G MANUAL shows the contents of an online Help document. IMPORT FROM USB imports the Help document into the device memory from an USB memory stick.
PV624	Tap this menu row to show three available selections. VIEW ONLINE shows a QR code. Use a mobile phone to scan the code to access the Help system. VIEW PV624 MANUAL shows the contents of an online Help document. IMPORT FROM USB imports the Help document into the device memory from an USB memory stick.

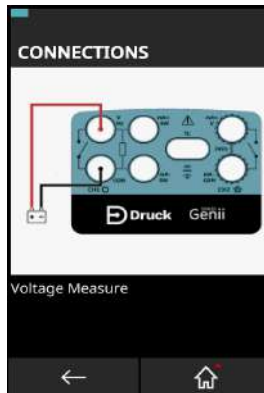

2.4 The SETTINGS screen

Tap the **Settings**  icon at the bottom of the **Home** screen to show the **SETTINGS** first screen.

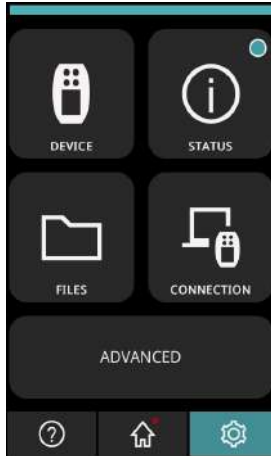



Figure 2-2: SETTINGS screen

This screen has these menu choices:

- **DEVICE** for the device settings (refer to Section 2.4.1 on page 20)
- **STATUS** for the operation mode values of the device (refer to Section 2.4.2 on page 22)
- **FILES** to access and edit some of the DPI620G user settings (refer to Section 2.4.3 on page 26)
- **CONNECTION** to access the external communication modes (refer to Section 2.4.4 on page 28)
- **ADVANCED** for access by only approved users for the calibration of the device and the use of software updates (refer to Section 2.4.5 on page 30).

Refer to “Dashboard Navigation” on page 16 for information about the three menu icons at the bottom of the screen.

2.4.1 SETTINGS - DEVICE

Tap the **DEVICE**  icon on the Dashboard to show the **DEVICE** menu screen.

These **Setting - Device** options can be changed:



Figure 2-3: SETTINGS - DEVICE options

2.4.1.1 INTENSITY (BRIGHTNESS)

To adjust the brightness intensity of the display, push and drag the slider icon left or right to decrease or increase the brightness.

2.4.1.2 DATE and TIME

Select the option in the **SETTINGS** screen to change the date and time.

2.4.1.3 LANGUAGE

Select the necessary language from the list of available languages

2.4.1.4 THEME (DISPLAY)

To make the device display visibility better, select the theme from these two options:

Theme	Description
Dark	Presents white/light text on dark gray screen background.
Light	Presents dark/black text on light gray screen background.

2.4.1.5 VOLUME

To adjust the sound volume on the device, push and drag the slider left to reduce the volume or right to increase the volume.

2.4.1.6 NOTIFICATION

Select the option (click on Checkbox to add tick mark) to turn ON or OFF messages for when **USER UPGRADABLE** or **FACTORY UPGRADABLE** software components have an available update.

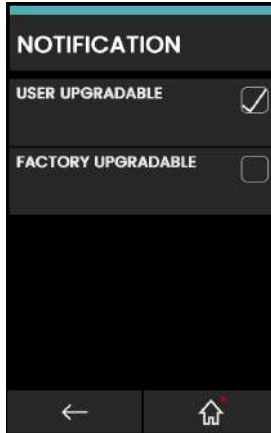

Figure 2-4: NOTIFICATION menu

2.4.1.7 STANDARDS

Select the necessary International Temperature Scale (ITS) standard for the device to use. The two options available are IPTS-68 and ITS-90.

Note: Default selection is ITS-90.

2.4.1.8 ENABLE HOLD ICON

Select the tick box to enable or disable the **Hold** function icon  shown by the **Calibrator** screen.

In the **Calibrator** screen, the **Hold** icon stops all measurements for all channels. Tap the **Hold** icon again to select live measurements.

If the **Hold** icon is disabled in the **SETTINGS** screen, it is still possible to make it available from the **Calibrator** screen when the icon is tapped.

2.4.2 SETTINGS - STATUS

Tap the **Status**  icon on the Dashboard to show the **STATUS** menu. The **Status** options are shown in Figure 2-5.

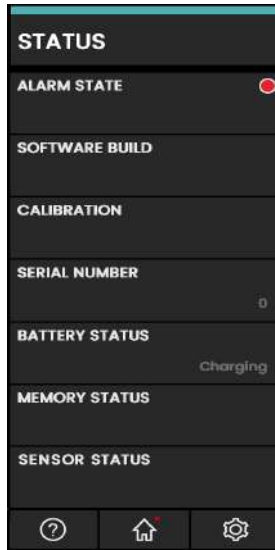

Figure 2-5: STATUS menu

Note: The **SENSOR STATUS** option will be in the menu when you attach an external sensor to the device.

2.4.2.1 ALARM STATE

A red LED on the **ALARM STATE** section of the **STATUS** menu shows the **Alarm** status. This is also on the **Status** icon and on the **Home** icon in other screens.

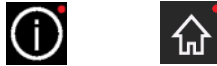

Figure 2-6: Alarm Indication

The red LED shows alarm messages, for example: **DATE/TIME NOT SET**, **CALIBRATION OVERDUE**.

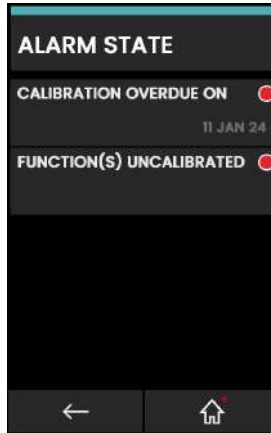

Figure 2-7: Alarm State

Select the alarm on show to clear the **Alarm** message until the next device restart.

Chapter 2. Instrument Operation

2.4.2.2 SOFTWARE BUILD

Select **SOFTWARE BUILD** to see the version number of the software in control of the DPI620G.

Note: A red dot in a row shows that an upgrade is available for that module.

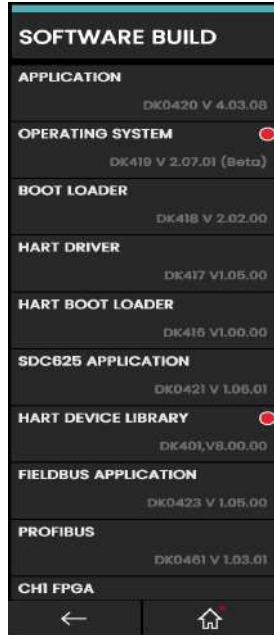

Figure 2-8: Software Build Status

The software available on the DPI620G types are:

	DPI620G	DPI620G-B	DPI620G-IS
Application	DK0420	DK0420	DK0420
Operating System	DK419	DK419	DK448
Boot Loader	DK418	DK418	DK447
HART® Driver (Processor Application)	DK417	DK417	DK464
HART® Boot Loader	DK416	DK416	DK463
SDC625 Application	DK421	DK421	DK421
HART® Device Library	DK401	DK401	DK401
FIELDBUS Application	DK423	DK423	DK423
PROFIBUS	DK461	DK461	DK461
CH1 FPGA	DK413	N/A	DK458
CH2 CPLD	DK414	DK414	DK459
PSU Board CPLD	N/A	N/A	DK0457
DPI620G Bluetooth Smart Basic Application	DK0531	DK0531	N/A
Bluetooth Module Firmware (Bootloader)	DK0527	DK0527	N/A

2.4.2.3 CALIBRATION

The Calibration status screen:

- **NEXT DUE ON** shows the date of the next calibration.
- **LAST CALIBRATION DATE** shows the date of the last calibration.

2.4.2.4 SERIAL NUMBER

This screen shows the serial number of the DPI620G device.

2.4.2.5 BATTERY STATUS

This screen shows the percentage “100% (Fully charged)” of the battery charge of the DPI620G device. It can also show “Charging” when the battery receives a charge.

2.4.2.6 MEMORY STATUS

This screen shows the percentage portion of the device memory in use and that which is available. The memory information is related to the:

- **INTERNAL** device memory
- **USB FLASH DRIVE.** Note:
The DPI620G has two USB ports:
- A USB A for access to a USB flash card.
- A USB mini for access to a SD memory.
The DPI620G-IS has one USB mini port for use as a Client connection: refer to Section 2.4.5.2 on page 32 for more information. This port can also be used in storage mode for access to SD memory.
- **SD CARD** (internal).

2.4.2.7 SENSOR STATUS

This screen shows information about connected external sensors, for example: the **PM 620 / PM 620T** modules.

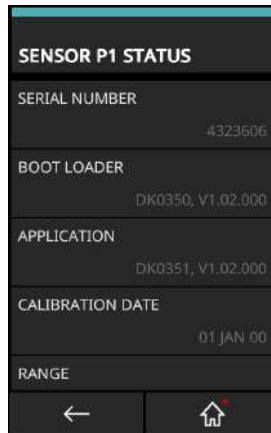



Figure 2-9: Sensor Status

2.4.3 SETTINGS - FILES

Tap the **Files**  icon to access and change the DPI620G User settings.

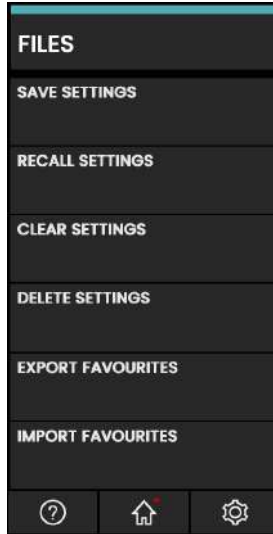

Figure 2-10: Files Menu

2.4.3.1 SAVE SETTINGS

Saves in the internal storage of the device all the User settings in use.

2.4.3.2 RECALL SETTINGS

Show on the device screen all User setting files in the internal storage of the device.

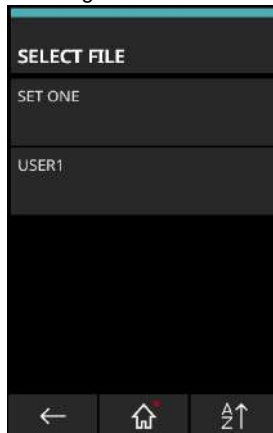

Figure 2-11: Selection of a Saved User Settings File to Recall

2.4.3.3 CLEAR SETTINGS

This command makes factory default settings replace the User settings in use.

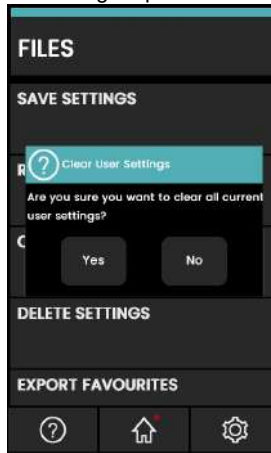

Figure 2-12: Clear Settings Confirmation

2.4.3.4 DELETE SETTINGS

Erases selected Settings files that are in storage.

2.4.3.5 EXPORT FAVOURITES

This option makes copies of the **Favourite** files that the device has in internal storage. A USB flash drive must be put into the DPI620G, and sensed successfully for the storage of these files.

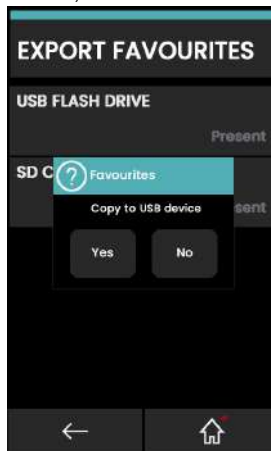
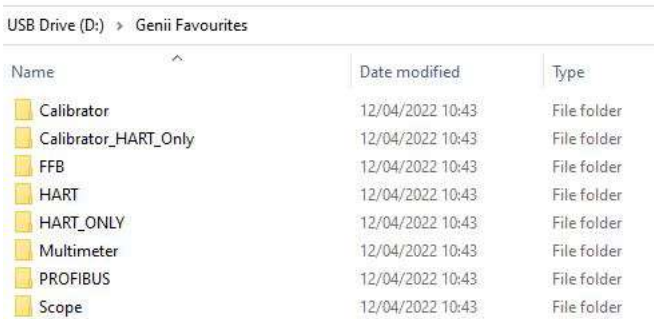

Figure 2-13: Export Favorites to USB Flash Drive

Chapter 2. Instrument Operation

The control system automatically makes these folders on the USB flash drive, as part of the copy command:



USB Drive (D:) > Genii Favourites

Name	Date modified	Type
Calibrator	12/04/2022 10:43	File folder
Calibrator_HART_Only	12/04/2022 10:43	File folder
FFB	12/04/2022 10:43	File folder
HART	12/04/2022 10:43	File folder
HART_ONLY	12/04/2022 10:43	File folder
Multimeter	12/04/2022 10:43	File folder
PROFIBUS	12/04/2022 10:43	File folder
Scope	12/04/2022 10:43	File folder

Figure 2-14: Folders Created for Exported Favorites

2.4.3.6 IMPORT FAVOURITES

Imports **Favorite** files into the device that a USB flash drive has in storage.

A USB flash drive that has the correct **Favorites** setup folder must be detected successfully to complete this action.

2.4.4 SETTINGS - CONNECTION

Push the **Connection**  icon on the Dashboard, to show the **CONNECTIONS** menu.

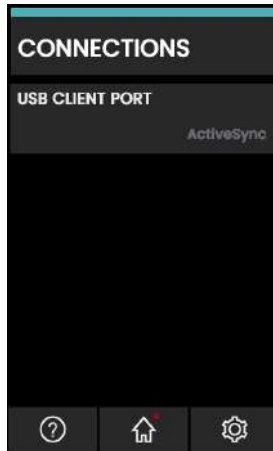

Figure 2-15: Devices Menu

Push the **USB CLIENT PORT** button to show the three connection modes available.

2.4.4.1 USB Client Port

The DPI620G USB port can operate in one of three modes:

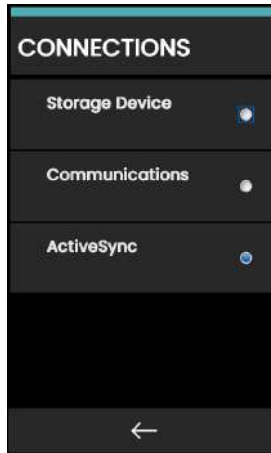

Figure 2-16: USB Client Port Configuration Menu



USB Client Port Option	Description
Storage Device	To look at and access the internal file system of the DPI620G storage when it connects to a PC.
Communications	For use with 4Sight2™ software communication.
ActiveSync	For use with Microsoft® Windows® CE™ applications.

2.4.5 SETTINGS - ADVANCED Menu

Only users with the necessary approval must calibrate the DPI620G. Push the **Advanced** button on the **SETTINGS** home screen (see “The SETTINGS screen” on page 19) to show the **Advanced** menu (See Section 12) and if necessary, update its software components (See Section 2.4.5.1).

2.4.5.1 How to upgrade the Software (DPI620G & DPI620G-B)

Download the software update files from the website into a USB flash memory device. The files are compressed in a zipped folder and will have to be extracted from within the USB memory device before you start the upgrade.

1. Tap the **Settings**  icon on the Dashboard and then tap the **ADVANCED** menu button at the bottom of the screen.
2. Enter the calibration PIN: 5487 and tap the **Tick**  icon to access the software upgrade screen.

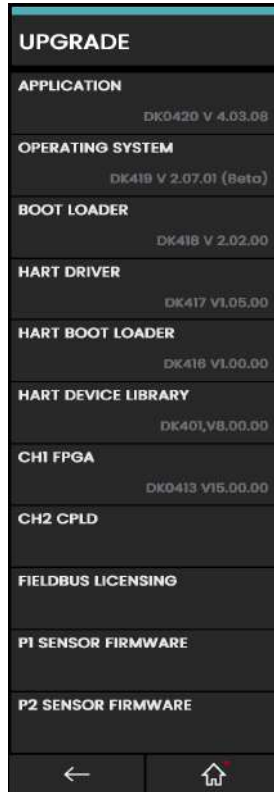

Figure 2-17: Software Upgrade Menu

Continue with one of the these upgrade operations:

1. Upgrade the Operating System (DK419) and Bootloader software (DK418).
Copy the folder named **'OS'** into the root of the USB flash memory device:
 - a. Insert the USB flash memory device into the USB type A port.
 - b. On the device screen, select **OPERATING SYSTEM**.
 - c. Obey the instructions shown by the screen.

Note: The bootloader can only be upgraded as part of an operating system upgrade.
2. Upgrade the Application software (DK420) and SDC625 Application (DK421).
Note: If an Operating System upgrade is necessary, it is recommended to upgrade the Operating System **before** the Application software.
Copy the the 'AMC' application folder into the root of the USB flash memory device:
 - a. Insert the USB flash memory device into the USB type A port.
 - b. Select **APPLICATION** on the device screen.
 - c. Obey the instructions shown by the screen.

Note: The SDC625 HART® Application can only be upgraded by an application upgrade.
3. Upgrade the HART® Processor Application (DK417) and Boot Loader (DK416).
Copy the folder named 'HART' into the root of the USB flash memory device:
 - a. Insert the USB flash memory device into the USB type A port.
 - b. On the device screen, select **HART® APPLICATION**.
 - c. Obey the instructions shown by the screen.

Note: The HART® bootloader can only be upgraded as part of the HART® application upgrade.
4. Upgrade the **CH1 FPGA**.
Copy the folder named 'FPGA' into the root of the USB flash memory device:
 - a. Insert the USB flash memory device in the USB type A port.
 - b. Select **CH1 FPGA** on the device screen.
 - c. Obey the instructions shown by the screen.

Note: The **CH2 CPLD** cannot be remotely upgraded.
5. Upgrade the HART® Device Library.
By default, the HART® device library is stored on the DPI620G internal micro SD card. There are two methods to upgrade the HART® Device Library.

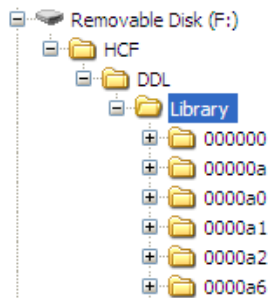

Figure 2-18: HART® Device Library Folder Structure

Chapter 2. Instrument Operation

- a. Method 1 – Use a USB flash drive
 1. Download the HART® Library update files from the website and extract the zipped folder onto a USB flash drive.
 2. Make sure the HCF folder is in the root directory of the USB flash drive. The necessary directory structure on the USB flash drive is in Figure 2-18.
 3. Insert the USB flash drive that has the HCF folder into the DPI620G.
 4. From the **Software Upgrade** menu, select the **HART® Device Library (DK401)**.
 5. Obey the instructions shown by the screen.
 6. The Upgrade operation will take approximately 30 minutes.
- b. **Method 2 – Use a PC and USB cable**
 1. Download the HART® Library update files from the website and extract the zipped folder onto a PC hard drive.
 2. Connect the DPI620G Client USB port to the PC USB port. The DPI620G will connect to the PC as a USB flash memory device.
 3. Copy the HCF folder into the root directory of the DPI620G USB flash memory device. The necessary directory structure on the DPI620G USB flash memory device is in Figure 2-18.

Note: If a mistake is made in the upgrade and there are no files to upload, obey the instructions on the screen and complete the procedure.

Note: When an upgrade completes correctly, the operation of the touchscreen can be slower than usual (a period of approximately 30 seconds).

Note: To make sure the upgrade has completed correctly, go to the **Status** menu on the Dashboard. The revision number of the application must be that of the uploaded application.

2.4.5.2 How to upgrade the Software (DPI620G-IS)

DPI620G-IS application upgrade (by the use of the power button)

1. Energize (power on) the DPI620G-IS. Connect the DPI620G-IS to a PC from the USB port. The screen will show the instrument as an external device, for example, (DPI620 (F:)).
2. Copy the AMC folder to F:/Install.
3. Push and hold the power button to de-energize (power off).
4. Push and hold the power button to energize (power on) and continue to hold until the screen shows the question “Force OS Upgrade - Yes or No”. Select No.
5. The application automatically is upgraded.
6. Release the power button when the screen shows the progress bar. This can take a few seconds.
7. Wait until the upgrade completes and the upgraded application operates. This will happen automatically and can take several minutes.

DPI620G-IS application upgrade (from within the DPI620G-IS application)

1. Energize (power on) the DPI620G-IS. Connect the DPI620G-IS to a PC from the USB port. The screen will show the instrument as an external device, for example, (DPI620 (F:)).
2. Copy the AMC folder to F:/Install.
3. From the dashboard, tap the **'Advanced'** button.
4. Enter PIN number 5487.
5. Select **Upgrade** option from the menu.
6. Select the **APPLICATION** option.

7. Select 'Yes' from the 'Confirm Upgrade' prompt.
8. De-energize (power off) and start the instrument again when the screen shows the 'Software Upgrade' message.
9. The application software automatically be upgraded.
10. Wait until the upgrade completes and the upgraded application operates. This will happen automatically and may take several minutes.

3. Calibrator

3.1 Basic Calibrator Operation

Tap the **CALIBRATOR**  icon on the Dashboard to show the **CALIBRATOR** screen.

3.1.1 Layout

The calibrator screen shows measurement or source functions which are in channel groups. More than one channel can be on the calibrator screen. These six channels are available:

- *Electrical - Channels “**CH1**” and “**CH2**”.
- Pressure (via PM620 / PM620T and MC620G) - Channels “**P1**” and “**P2**”.
- External Sensor (USB) - supports sensors such as **TERPS**, **IDOS** or **RTD-INTERFACE**.
- Communications - supports HART®, FOUNDATION™ Fieldbus and Profibus®.

* The DPI620G-B has only one electrical channel, **CH**, which is equivalent to the DPI620G **CH2** channel.

There are two display views (normal and expanded) in the CALIBRATOR screen when multiple channels are in use. Figure 3-1 shows a normal view with three selected channels.

To expand the view of a channel, tap in the area of the channel window.

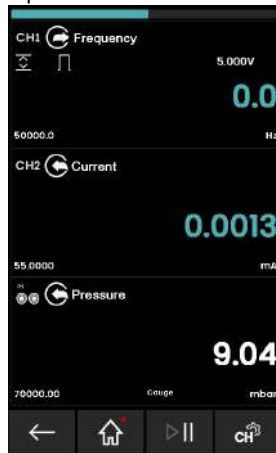

Figure 3-1: Calibrator Window – Normal View (Three Channels)

To show the **TASK MENU** (Section 3.3 on page 37) screen, you can either swipe your finger from right to left (←) on the **CALIBRATOR** screen or tap the **CHANNEL SETTINGS**  icon in the bottom right corner of the display.

Figure 3-2 shows an expanded view of the selected channel (CH2) and makes the other channels (CH1 and P1) have a minimum area.



Figure 3-2: Calibrator Window – Expanded View on CH2

3.1.2 Calibrator Screen Information

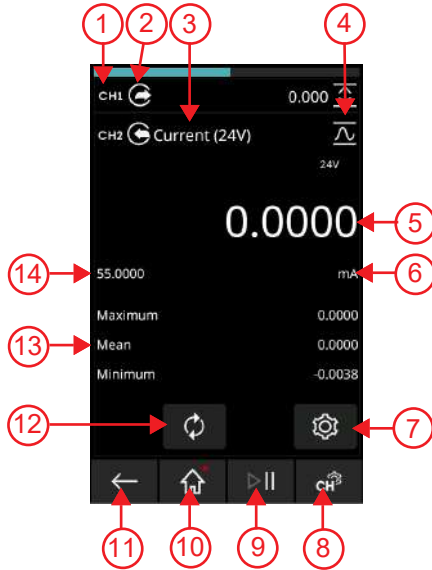

- | | |
|--------------------------------|--------------------------------------|
| 1 Channel identification | 2 Channel Direction (Source/Measure) |
| 3 Channel Function | 4 Utility Icon |
| 5 Measurement Reading | 6 Measurement Unit |
| 7 Channel Settings | 8 Task Menu |
| 9 Hold/Pause Readings | 10 Home or Dashboard |
| 11 Go back one screen | 12 Reset |
| 13 Additional Measurement Data | 14 Sensor Full-scale value |

Figure 3-3: Calibrator Screen Information Example

3.2 Error Indications

Display	Condition
<<<<<	Under Range: The display shows this symbol for this condition: Reading < 110% Negative Full Scale (Pressure) Reading < 102% Negative Full Scale (Electrical)
>>>>>	Over Range: The display shows this symbol for this condition: Reading > 110% Positive Full Scale (Pressure) Reading > 102% Positive Full Scale (Electrical)

1. Make sure that the range is correct.
2. Make sure that all the related equipment and connections are serviceable.

3.3 TASK MENU

Use your finger and swipe from right to left (←) on the calibrator screen to show the **Task Menu**.

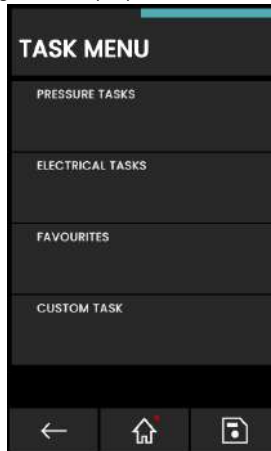

Figure 3-4: Task Menu

3.3.1 PRESSURE TASKS

Select **PRESSURE TASKS** from the **Task Menu** to show a list of predefined pressure related tasks.

The **PRESSURE TASKS** option will only be available if a pressure sensor is detected, such as the **PM620**, **PM620T**, **IDOS UPM** or **TERPS USB**.



Figure 3-5: Pressure Tasks

Select the necessary function by the use of either the related text or diagram. The DPI620G will set the functions and then show the Calibrator screen.

3.3.2 ELECTRICAL TASKS

Select **ELECTRICAL TASKS** from the **TASK MENU**. This lets the user select from a list of electrical function combinations.



Figure 3-6: Electrical Tasks

Tap either the related text or diagram to select the necessary function. The DPI620G will set the functions and then show the Calibrator screen.

3.3.3 SAVE TASK

Tap the **Save Task**  icon at any point within the **Task Menu** to save a active task to **Favourites** (refer to Section 3.3.4).

Note: The Calibrator window shows the saved function. It does NOT show a selected Task. Refer to **Add to Favourites** in Section 3.3.4.

3.3.4 FAVOURITES

Select the related tick box for the function or task set-up (as shown in Figure 3-7) you want to save and then select the **Add to Favourites**  icon.



Figure 3-7: Selected Task

1. Select **FAVOURITES** from the **Task Menu** to show all saved and copied tasks. You can then select the wanted task.
2. Tap on either the related text or image to select the necessary function. The DPI620G will set the functions and then show the Calibrator screen.

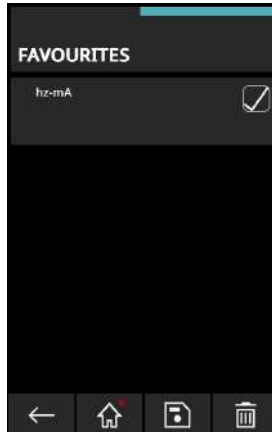



Figure 3-8: Favourite Tasks

3. To delete a **Favourite** task select the tick box for the task, as shown in Figure 3-8, and tap the **Delete**  icon. The screen will then show a screen prompt message for you to confirm the delete operation. To save a selected user task, tap the **Save**  icon: there will be a screen prompt message to save the task as a named filename. If the necessary task is not available as a default, you can use **CUSTOM TASK** to save a new task. Refer to Section 3.3.5.

3.3.5 CUSTOM TASK

1. Select **CUSTOM TASK** from the **Task Menu** (see Figure 3-4 on page 37). This shows the **TASK SETTINGS** screen.

This allows the user to individually set up **CH1** and **CH2**, in addition to the Pressure Channels **P1** and **P2**, **USB (IDOS or TERPS)** and **Communications (HART®, FOUNDATION™ Fieldbus or Profibus®)**.



Figure 3-9: Task Settings Menu

Table 3-1: Calibrator Channel Description

Channel	Description
CH1*	Set up CH1 by the use of the CHANNEL SETTINGS menu (page 41).
CH2*	Set up CH2 by the use of the CHANNEL SETTINGS menu (page 41).
CH±**	Set up CH by the use of the CHANNEL SETTINGS menu (page 41).
P1 ⊙⊙	Use P1 for pressure measurements with a pressure module connected on position P1 in the pressure module carrier. Refer to Section 5.
P2 ⊙⊙	Use P2 for pressure measurements with a pressure module connected on position P2 in the pressure module carrier. Refer to Section 5.
⊙	Use for external sensors: IDOS , TERPS or RTD-Interface . For more information refer to Section 5 and Section 6.
⚡	Use for HART® , FOUNDATION™ Fieldbus and Profibus® PA . For more information refer to Section 9, Section 10 and Section 11.

* **CH1** and **CH2** are available in the DPI620G and DPI620G-IS.

** **CH** is only available in the DPI620G-B.

2. The **CHANNEL SETTINGS** menu lets you prepare the selected channel for measurement.



Figure 3-10: Channel Settings Menu





- **DIRECTION** selects  Source or  Measure for the selected function.
- **FUNCTION** selects the necessary channel function (for example, Current or Voltage). For more options, swipe your finger up the device screen. Each channel has a different list of functions available. For example, Electrical channels **CH1** and **CH2** will not have pressure related functions and Pressure channels **P1** and **P2** will not have electrical functions.
- **UNITS** selects the type of measurement unit. For example, Hz, kHz. The selected function controls what unit options are available. For some functions only one type of unit will be available (for example, mA for current).
- **UTILITY** selects the wanted function utility. Refer to Section 3.5 for more information.
- **CAPTION** lets the user change the caption or label of the channel. A caption is the title text that is next to the channel and direction icon, at the top of each channel window.



Figure 3-11: Channel Settings Menu

To change the caption, tap in the channel area to show the related **CHANNEL SETTINGS** screen for the channel, then tap the **CAPTION** menu button. Enter the new caption text (for example, "Caption", as shown in Figure 3-11) and tap the **tick** icon at the bottom right of the screen. The display then shows the **CHANNEL SETTINGS** screen. Tap the **tick** icon at the bottom right of the screen to set the new caption.

- **RESET CAPTION** allows the user to change the caption to the factory default caption.
3. When all settings are selected, tap the tick  icon at the bottom of the screen to save and then show the **TASK SETTINGS** screen.
 4. Repeat the above instructions if you want to use more than one channel.

Note: For the settings to be applicable, you must tap the  icon in the **TASK SETTINGS** menu.

3.4 Channel Function

Individual channels have **Direction** options for each function as either Measure or Source/Simulate.

Note: Pressure tasks are **Measure only** functions.

After you set the necessary measure and source functions on the display, additional features can be set for each shown function: some of these features are only for one type of function.

To select these functions tap in the channel's area to show an expanded view of the function. Tap the **Settings**  icon in this expanded view in this example to show the **SOURCE SETTINGS** screen*.

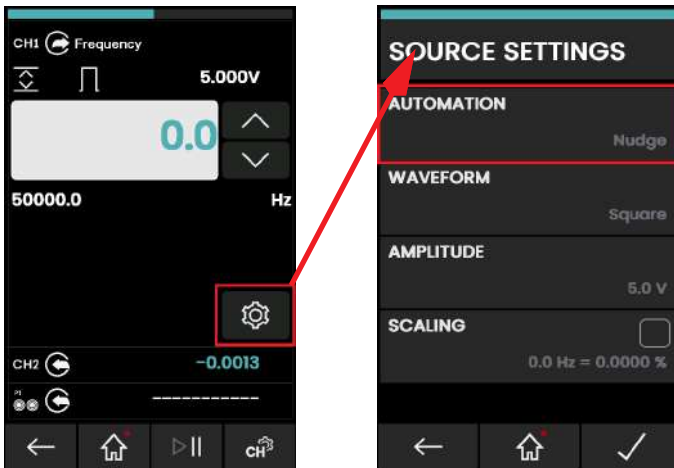

Figure 3-12: SOURCE SETTINGS screen

* For other functions this selection will show a **SETTINGS** menu screen.

Tap the **AUTOMATION** button to show the **PROCESS** menu screen. Refer to Section 3.4.1 on page 43 for more information.

3.4.1 Process

When the display shows the **PROCESS** screen you can select one of the available **AUTOMATION** functions. After you select a function the display will show a new **AUTOMATION** screen, with related function options if they are available, as shown by Figure 3-13 below.

The following Source Functions are available:

- **Nudge** - lets the source value increase by a specified **STEP SIZE** value.

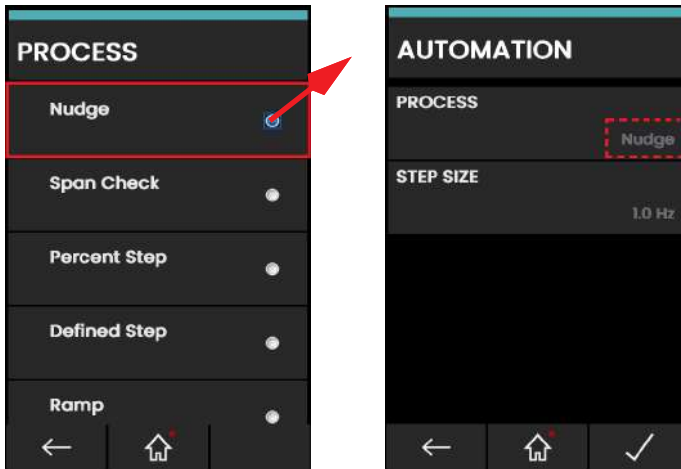



Figure 3-13: Selection of Automation Function

- **Span Check** - lets a two-point span check be done. The **LOW** (minimum) and **HIGH** (maximum) span values can be set, in addition to the **DWELL** time.
- **Percent Step** - lets the source value increase in steps related to a set percentage of the span. There is also the option to auto-repeat the automation process.
- **Defined Step** - lets the source value increase by a specified step value within the span limits. There is also the option to auto-repeat the automation process.
- **Ramp** - lets the source value increment automatically from a specified **START** value to a specified **END** value in steps of a specified value, in both an increasing and decreasing direction. The **TRAVEL** time can be set to define the period of time it takes the value to go from **START** to **END** or from **END** to **START**, while the **DWELL** time specifies the period for the source value to remain at the **END** value.

3.5 Utility Options

Only one utility can operate at a time for each function. Not all source and measure functions have related utilities. For all utility options the **Restart** icon  resets the additional readings given by the selected utility. Use these menu selections to show to the **Utility** screen:

1. Tap the **CALIBRATOR** icon on the Dashboard to show the **Calibrator** screen (see Section 3.1.1 on page 34).
2. Show the **TASK** menu screen (see Section 3.3 on page 37). Swipe your finger from right to left on the **TASK** screen or Tap the **Test Channel Settings**  icon in the bottom right corner of the screen.
3. Tap in the **CUSTOM TASK** (see Section 3.3.5 on page 40) row to show the **TASK SETTINGS** screen.



Figure 3-14: TASK SETTINGS

4. Tap in the **UTILITY** row to show a screen that lists the available Utility options.



Figure 3-15: Selection of UTILITY screen

- Tap in the row that has the necessary **UTILITY** option. In this example, the **Switch Test** option is selected..

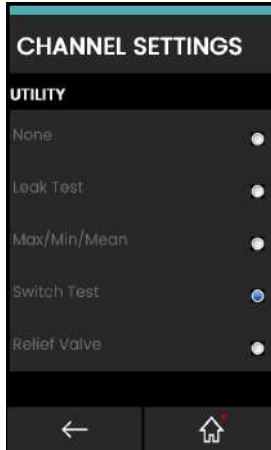



Figure 3-16: Selection of UTILITY option

The utilities available are in the above screen: **Leak Test** (see Section 5.7 on page 80), **Max/Min/Avg** (see Section 3.5.1 below), **Switch Test** (see Section 3.5.2 on page 46), and **Relief Valve** test (see Section 3.5.3 on page 46).

Tap the row for the option to select it and go back to the first **CHANNEL SETTINGS** screen. Tap the tick ✓ icon in **CHANNEL SETTINGS** screen to set the selection.

3.5.1 Max/Min/Avg

The  **Max/Min/Avg** utility is only available with measurement functions.

When you select this utility, the screen will show the real-time **Minimum**, **Maximum**, and **Average** values (**Mean**) of the measured signal, in addition to the real-time measured signal value.

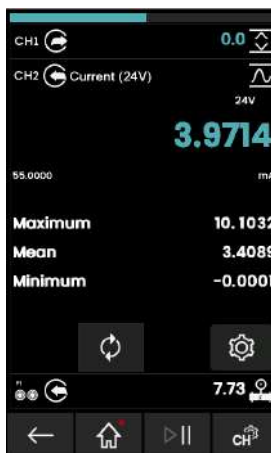



Figure 3-17: Max/Min/Avg Example

3.5.2 Switch Test

The  Switch Test is available with measure or source functions.

The additional readings show signal values (measure or source) when the instrument senses how much a switch moves to its open or closed position. The difference between the two values is shown as the hysteresis value for the switch. This utility can be used with Ramp Automation, where the rising signal causes the switch to change state and the falling signal causes the switch to go to its original state.

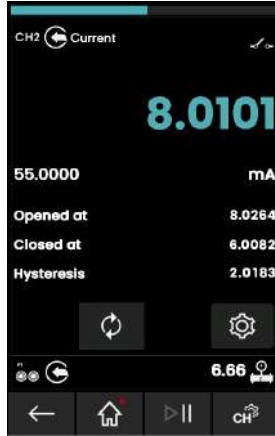



Figure 3-18: Switch Test Example

3.5.3 Relief Valve

The  Relief Valve utility is only available with Measure functions.

This utility is for tests of circuits or mechanisms that have a cut-out response when an input reaches a specified threshold value. The utility allows the user to select a mode of operation that increases or decreases. The utility shows additional values that show the **Maximum** and **Minimum** values made by the input signal.

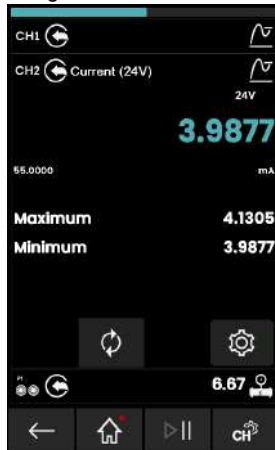

Figure 3-19: Relief Valve Example

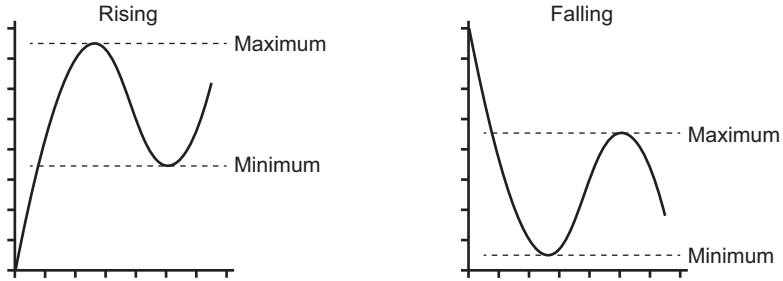

Figure 3-20: Relief Valve Utility

3.6 Process Options

Process options are related to the measured values for identified channel functions. Options available are related to the function and include:

Option	Description
Tare	Used to set a temporary value for zero. This makes an adjustment to all subsequent readings on the display
Alarm	Shows when a limit has been exceeded
Filter	Sets the Band and Time Constant for a low-pass filter
Flow	When selected, the square root of the measured value is shown.
Scaling	Absolute values are scaled.

4. Electrical Tasks

The DPI620G has the following electrical functions:

- Current (measure & source)
- Voltage (measure & source)
- Thermocouple (measure & simulate)
- Frequency (measure & source)
- Resistance (measure & simulate)
- RTD (measure & simulate)
- Pulses (measure & source)
- Observed (source) - allows a value to be manually entered, for example: the reading of a connected voltmeter.

To get access the **ELECTRICAL TASKS** menu: select from the dashboard screen, **CALIBRATOR**, then **TASK MENU**, then **ELECTRICAL TASKS**.

Refer to Chapter 3.3 on page 37 for information about the selections available in the **TASK MENU**.

4.1 Measure or Source Current

4.1.1 DPI620G Measure or Source Current

Figure 4-1 shows **CH1** set to measure a current with external loop power.

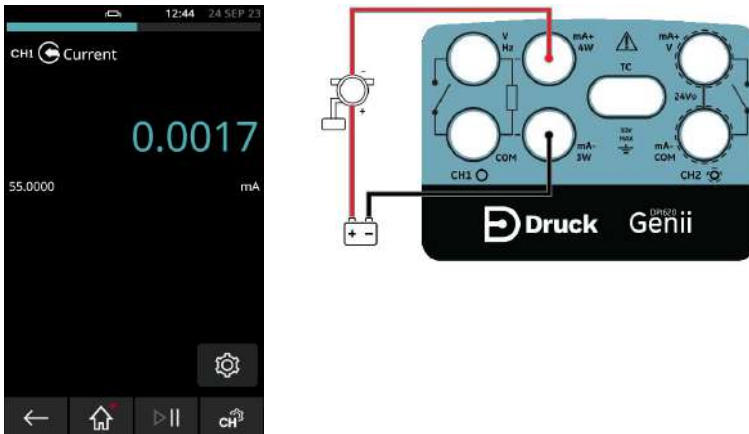

Figure 4-1: Measure Current on CH1 (Range \pm 55mA)

1. Set the applicable channel options: **CH1** (or **CH2**), **Measure** (or **Source**), Current, mA.
2. Complete the electrical connections as shown and continue with the measure or source operation.

4.1.2 DPI620G-IS Measure or Source Current (CH1)

Figure 4-2 shows **CH1** set to measure or source a current with external loop power.



Figure 4-2: Measure Current on CH1 (Range $\pm 55\text{mA}$)

1. Set the applicable channel options: **CH1**, **Measure** (or **Source**), Current, mA.
2. Complete the electrical connections as shown and continue with the measure or source operation.
3. Source only (Automation): set the applicable output value.

4.1.3 DPI620G-IS Source Current, Internal 15V Loop Power, CH2

Figure 4-3 shows **CH2** set up to source current (0 to 24mA) with an internal loop power (15V). An internal resistor (10 ohms) and series current source MOSFET are between the 'mA/V' and 'mA/COM' terminals. The current limit of the Loop power is 40mA.



Figure 4-3: Source Current on CH2 with Internal 15V Loop Power, Range 0 to 24mA)

1. Set the applicable channel options: **CH2**, **Source**, Current (15V), mA.
2. Complete the electrical connections as shown and continue with the source operation.
3. Source only (Automation): set the applicable output value.

4.2 Measure DC Voltage

4.2.1 DPI620G Measure DC Voltage

Figure 4-4 shows CH1 set up to measure a DC voltage (0 to 30V) or DC mV (0 to 2000mV).

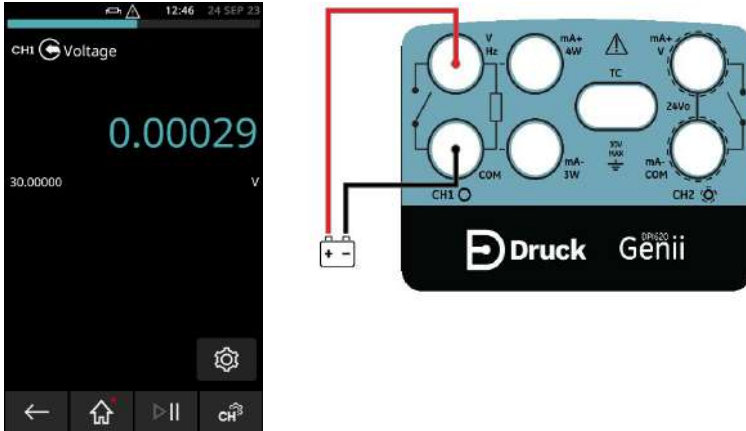

Figure 4-4: Measure DC Volts or DC mV on CH1 (Range $\pm 30V$)

Note: When you use the CH2 connectors, set up CH2 to measure this range.

1. Set the applicable channel option: **CH1**, Measure, Voltage (or Millivolts), V (or mV).
2. Complete the electrical connections and continue with the measure operation.

4.2.2 DPI620G-IS Measure DC Voltage

Figure 4-5 shows CH1 set-up to measure a DC voltage (0 to $\pm 30V$) or DC mV (0 to $\pm 2000mV$).



Figure 4-5: Measure DC Volts or DC mV on CH1, Range $\pm 30V$

1. Set the applicable software options: **CH1**, Measure, Voltage/Millivolts, V/mV.
2. Complete the electrical connections and continue with the measure operation.

4.2.3 DPI620G-IS Measure DC Volts or DC mV on CH2 (Range ± 30 V)

Figure 4-6 shows **CH2** set-up to measure a DC voltage (0 to ± 30 V) or DC mV (0 to ± 2000 mV).

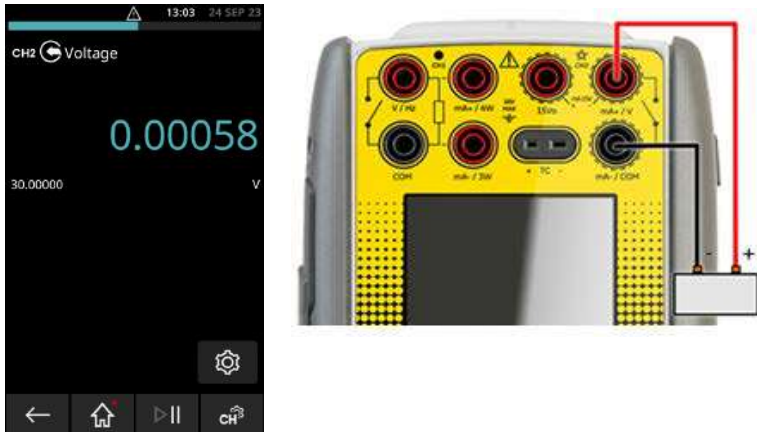

Figure 4-6: Measure DC Volts or DC mV on CH2, Range ± 30 V

1. Set the applicable software options: **CH2**, Measure, Voltage/Millivolts, V/mV.
2. Complete the electrical connections and continue with the measure operation.

4.3 Measure AC Voltage (CH1) – 20V RMS Maximum

Note: This function is not available on a DPI620G-B.

4.3.1 DPI620G Measure AC Voltage (CH1) – 20V RMS Maximum



WARNING To prevent electrical shocks, use only the Druck specified AC probe (Part: IO620-AC) to measure AC voltages that are more than 20V RMS (maximum: 300V RMS). Refer to Section 4.4.

Figure 4-7 shows CH1 set-up to measure an AC voltage (0 to 20V RMS) or AC mV (0 to 2000mV RMS).

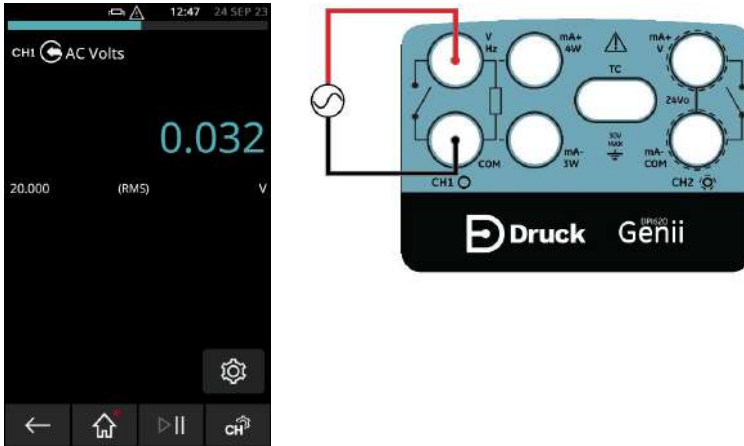

Figure 4-7: Measure AC Volts or AC mV on CH1 (Range \pm 20V RMS)

1. Set the applicable channel options: **CH1, Measure, AC Volts, V.**
2. Complete the electrical connections and continue with the measure operation.

4.4 Measure AC Voltage (CH1) – 300V RMS Maximum

4.4.1 DPI620G Measure AC Voltage (CH1) – 300V RMS Maximum



WARNING To prevent electrical shocks, use only the Druck specified AC probe (Part: IO620-AC) to measure AC voltages that are more than 20V RMS (maximum: 300V RMS). Attach it to the specified connections only.

Figure 4-8 shows CH1 set-up to measure an AC voltage with the AC probe Maximum: 300V RMS.

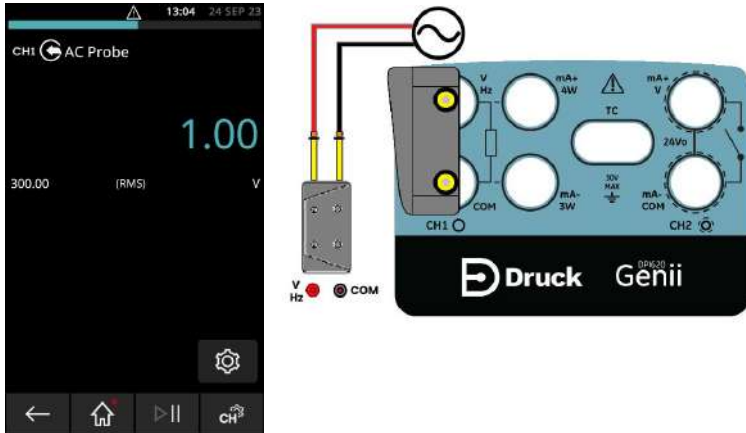

Figure 4-8: Measure AC Volts with AC Probe (Range 300V RMS)

1. Set the applicable channel option for the AC Probe.
2. Complete the electrical connections Red - V/Hz connector, Black - COM connector. Then continue with the measure operation.

4.5 Source DC Voltage (CH1)

4.5.1 DPI620G Source DC Voltage (CH1)

Figure 4-9 shows **CH1** set up to source a DC voltage on CH1 (0 to 20V).

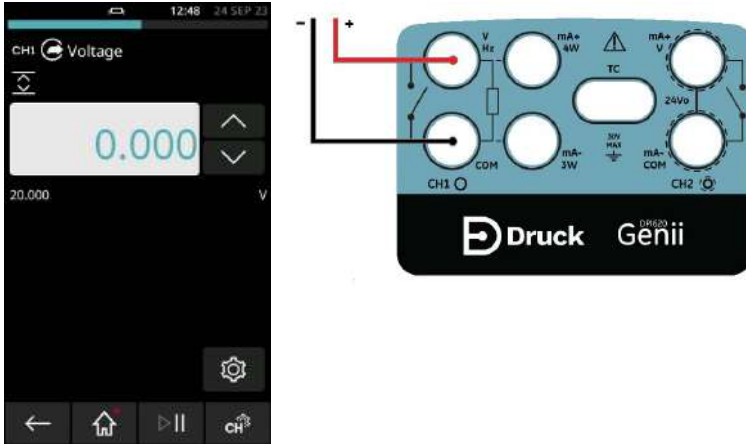

Figure 4-9: Source Voltage on CH1 (Range 0 to 20 V)

1. Set the applicable channel option to Voltage source.
2. Complete the electrical connections.
3. To continue, set the applicable output value.

4.5.2 DPI620G-IS Source DC Voltage CH1

Figure 4-10 shows **CH1** set-up to source a DC voltage (0 to 12 V) or DC mV (0 to 2000 mV).

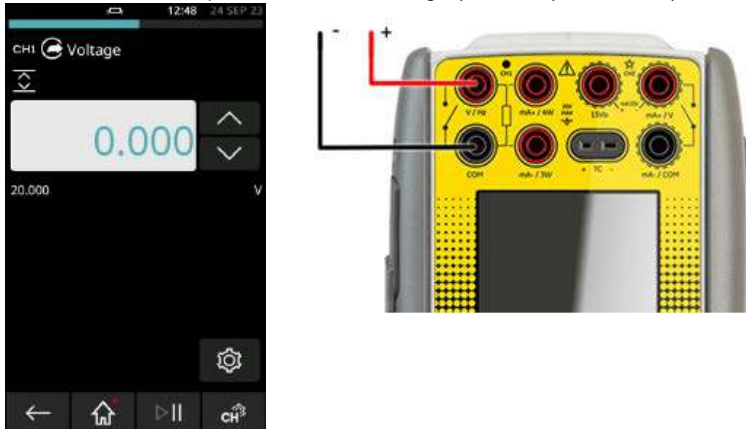

Figure 4-10: Source Voltage, CH1, Range 0V to 12V

1. Set the applicable software options: **CH1**, Source, Voltage/Millivolts, V/mV.
2. Complete the electrical connections.
3. To continue, set the applicable output value.

4.6 Measure or Source Current with Loop Power

4.6.1 DPI620G Measure or Source Current with Internal Loop Power

When using **CH2**, the current measure or source function can be set with the option of internal loop power supply.

Loop power has three possible settings:

1. None (current only)
2. 24V
3. 28V (not available on DPI620G-IS).

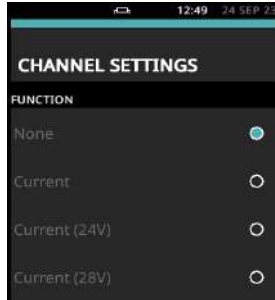

Figure 4-11: Current Loop Supply Options

Figure 4-12 and Figure 4-13 show the **CH2** set up to measure ($\pm 55\text{mA}$) or source (0 to 24mA) a current with internal loop power (Selectable to 24V or 28V).

1. Set the applicable channel options.
2. Complete the electrical connections and continue with the measure or source operation.
3. Source only (Automation): Set the applicable output value.

Note: The current limit of the Loop power is 30mA.

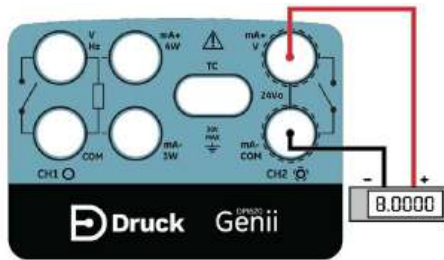

Figure 4-12: Source Current on CH2 with Internal Loop Power (Range: 0 to 24mA)

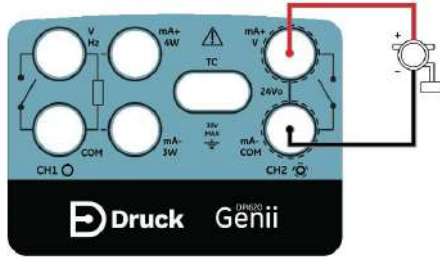

Figure 4-13: Measure Current on CH2 with Internal Loop Power (Range: 55mA)

4.6.2 DPI620G-IS Measure or Source Current (CH2)

CH2 can be set to measure or source current using internal or external loop power. Refer to Section 4.6.3 for examples of the use of internal loop power.



Figure 4-14: Measure Current on CH2 (Range ± 55 mA)

1. Set the applicable channel options: **CH2**, Measure (or Source), Current, mA.
2. Complete the electrical connections as shown and continue with the measure or source operation.
3. Source only (Automation): set the applicable output value.

4.6.3 DPI620G-IS Measure or Source Current with Internal 15V Loop Power, CH2

CH2 can be set to measure or source current together with internal or external loop power. Refer to Section 4.1.2 and Section 4.6.2 on page 56 for information about the use of external loop power. Internal 15V loop power becomes available for **CH2** functions measure and source current with the selection of internal 15V loop power. With these set-ups, an unregulated 15V supply is given across terminals '15Vo' and 'mA-/COM' as shown in Figure 4-15 below.



Figure 4-15: Connections for unregulated 15Vo Current Loop Output

4.6.4 DPI620G-IS Measure Current, Internal 15V Loop Power, CH2

Figure 4-16 shows **CH2** set up to measure a current ($\pm 55\text{mA}$) with internal loop power (15V). An internal resistor (10 ohms) is between the 'mA+/V' and 'mA-/COM' terminals. The current limit or the Loop power is 40mA.

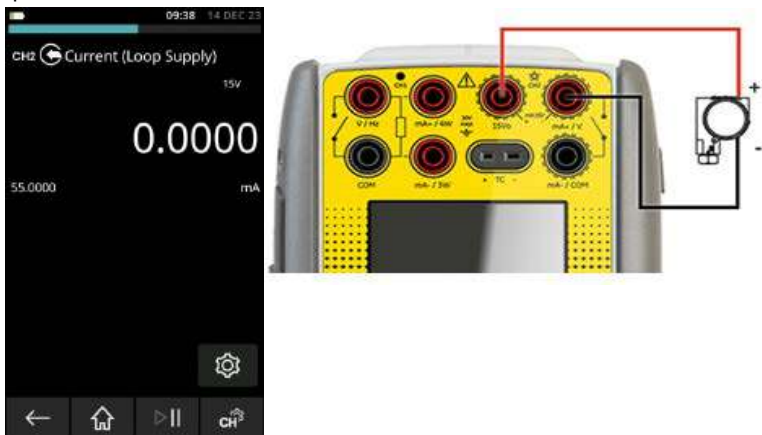

Figure 4-16: Measure Current on CH2 with Internal 15V Loop Power (Range $\pm 55\text{mA}$)

1. Set the applicable channel options: **CH2**, Measure, Current (15V), mA.
2. Complete the electrical connections as shown and continue with the measure or source operation.

4.7 Measure Frequency on CH1

Note: Information under this heading for **CH1** does not relate the DPI620G-B instrument.

4.7.1 DPI620G Measure Frequency on CH1

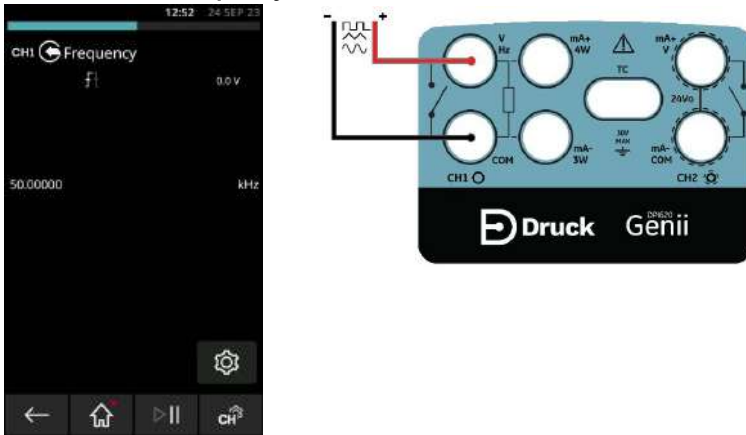



Figure 4-17: Example A – Measure Frequency on CH1 (Range 0 to 50kHz)

1. Set applicable channel options: **CH1, Source, Frequency, Hz** (or other unit).
2. Complete the electrical connections.
3. Default channel settings:
 - Range: 0 to 50kHz
 - Trigger level: 2.5V

If necessary, to adjust the Trigger level value tap the **SETTINGS**  icon and select **MANUAL LEVEL**.

4. **AUTO TRIGGER** can be set to on or off.

Note: Use the Manual Level for Manual Trigger only.

4.7.2 DPI620G-IS Measure Frequency Signals on CH1

Figure 4-18 shows **CH1** set-up to measure frequency. The units can be Hz, kHz or counts (cpm or cph).

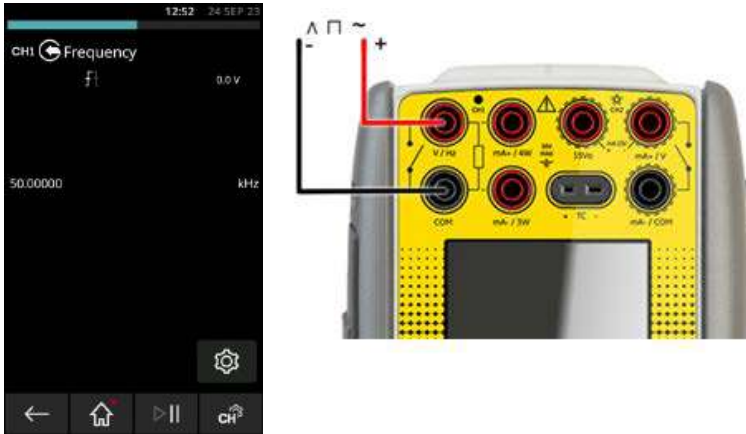



Figure 4-18: Measure Frequency on CH1 (Range 0 to 5kHz, Trigger Level 2.5V)

1. Set applicable channel options: **CH1**, Source, Frequency, Hz (or other unit).
2. Complete the electrical connections.
3. If necessary, to adjust the Trigger level value tap the **SETTINGS**  icon and select the **AUTO TRIGGER**.
4. Set these values:
 - **AUTO TRIGGER:** (Enabled / Disabled).
 - **MANUAL LEVEL:** Trigger Level for Manual Trigger only.

4.8 Source Frequency on CH1

4.8.1 DPI620G Source Frequency on CH1

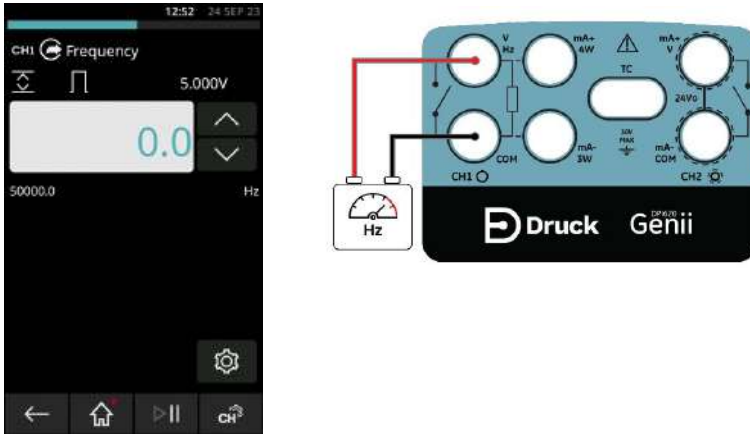

Figure 4-19: Example B – Source Frequency CH1 (Range 0 to 50kHz)

1. Set the applicable channel options.
2. Complete the electrical connections.
3. Default Range: 0 to 50kHz.

If necessary, change the **WAVEFORM** Setup in the **SETTINGS** . See Figure 4-20.

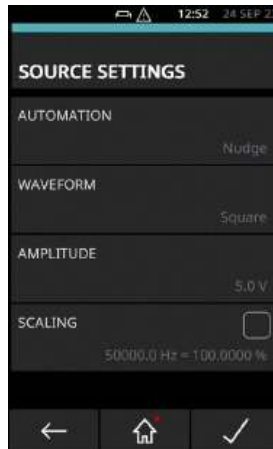

Figure 4-20: Source Frequency Settings

- **WAVEFORM** - Three Waveform options are available: Square (Default), Triangle, Sine:
- **AMPLITUDE** - Select the Peak-to-Peak value. Default amplitude is 5.0V.
- **OFFSET** - Set an offset value (this option is only available after the Sine or Triangle waveform has been selected).

4.8.2 DPI620G-IS Source Frequency Signals CH1

Figure 4-21 shows **CH1** set-up to source a frequency. The units can be Hz, kHz or counts (cpm or cph).

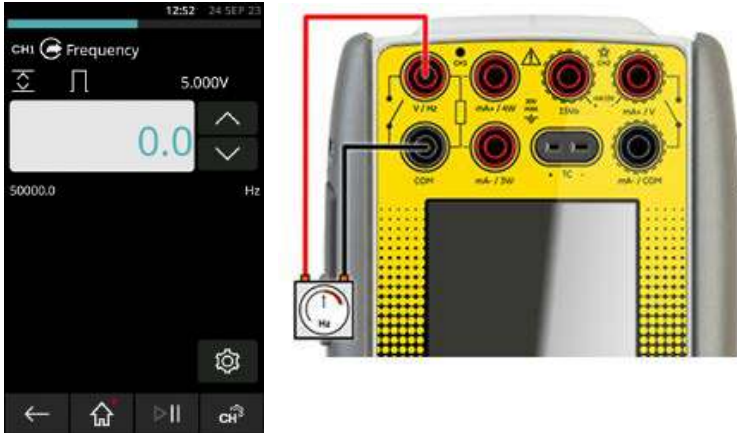

Figure 4-21: Source Frequency on CH1 (Range 0 to 5kHz, Trigger Level 2.5V)

1. Set the applicable channel options.
2. Complete the electrical connections.
3. Default range: 0 to 50kHz.

If necessary, change the **WAVEFORM** Setup in the **SETTINGS** . See Figure 4-22.

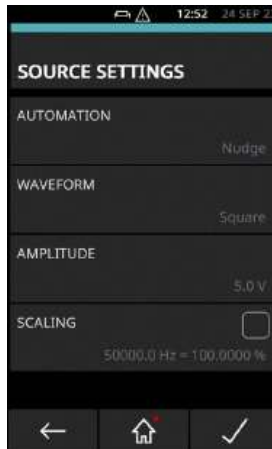

Figure 4-22: Source Frequency Settings

- **WAVEFORM** - Three Waveform options are available: Square (default), Triangle, Sine:
- **AMPLITUDE** - Select the Peak-to-Peak value: Default amplitude is 5.0V.
- **OFFSET** - Set an offset value (this option is only available after the Sine or Triangle waveform has been selected).

4.9 Measure or Simulate a Resistance Temperature Detector (RTD)

4.9.1 DPI620G Measure or Simulate a Resistance Temperature Detector (RTD)

Figure 4-23, Figure 4-24 and Figure 4-25 show CH1 set up to measure an RTD. A 4-wire setup gives the best accuracy; a 2-wire configuration has the lowest accuracy.

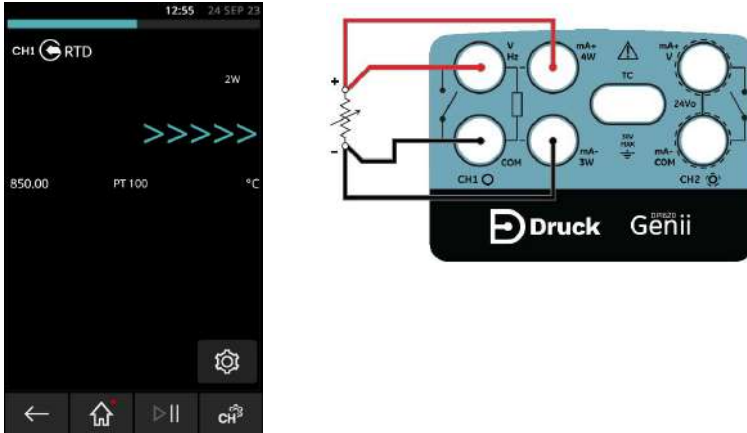

Figure 4-23: PT100 RTD Measure CH1 4-Wire (Range -200 to 850°C)

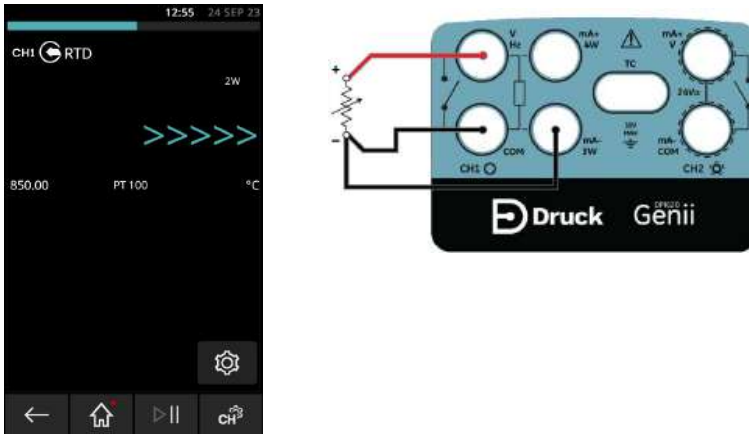

Figure 4-24: PT100 RTD Measure CH1 3-Wire (Range -200 to 850°C)

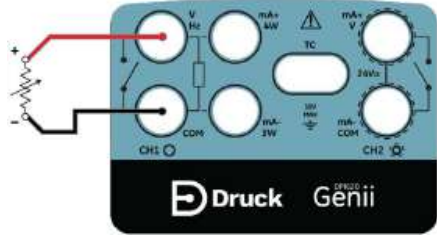



Figure 4-25: PT100 RTD Measure CH1 2-Wire (Range -200 to 850°C)

1. Set the applicable channel options.
2. Complete the electrical connections.
3. If necessary, change the RTD Type (default is PT100).

Select the **SETTINGS**  icon on the Dashboard then tap **RTD TYPE** and select the type of RTD sensor.

The **MEASURE OHMS MODE** can also be selected as Standard or True Ohms.

Note: To measure or simulate resistance Ω , select the Resistance function (Range 0 to 4000 Ω). To use a custom RTD setting, select the **CUSTOM RTD** tick box. Import the relevant custom RTD file to control this setting.

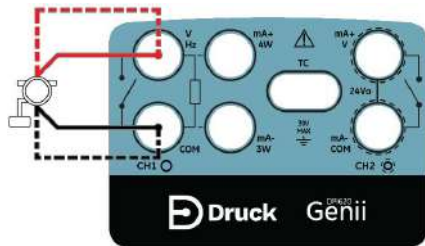

Figure 4-26: PT100 RTD Source CH1 4-Wire (Range -200 to 850°C)

Chapter 4. Electrical Tasks

4.9.2 DPI620G-IS Measure or Simulate a Resistance Temperature Detector (RTD)

Figure 4-27 and Figure 4-28 show **CH1** set to measure an RTD. A 4-wire setup gives the best accuracy; a 2-wire configuration has the lowest accuracy.

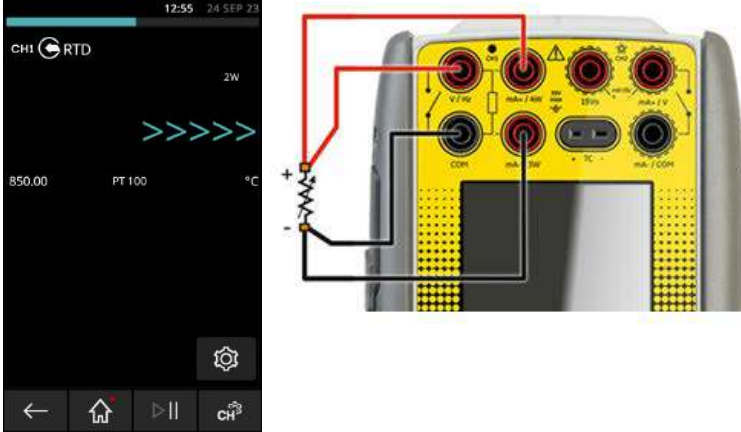

Figure 4-27: PT100 RTD Measure CH1 4-Wire (Range -200 to 850°C)

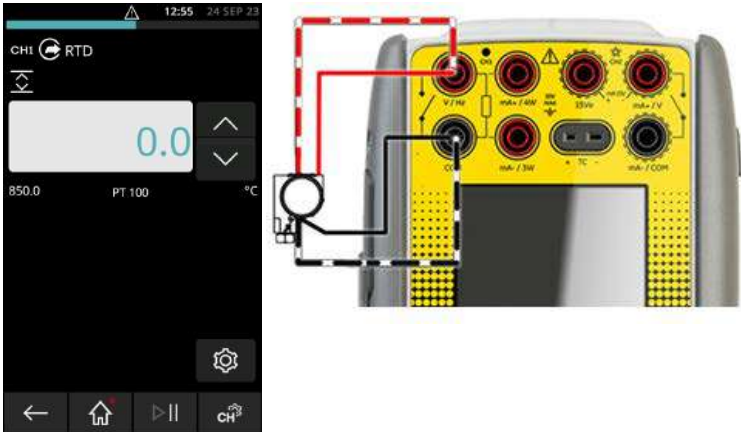



Figure 4-28: PT100 RTD Source CH1 4-Wire (Range -200 to 850°C)

1. Set the applicable software options: **CH1**, Measure/Source, RTD, Units.
2. Complete the electrical connections.
3. If necessary, change the RTD Type (default is PT100).

Select the **SETTINGS**  icon on the Dashboard, then tap **RTD TYPE** and select the type of RTD sensor.

Measure or Simulate a Resistance Temperature Detector (RTD)

Figure 4-29 shows a **CH1** set to measure a RTD by the use of a 3-wire cable..

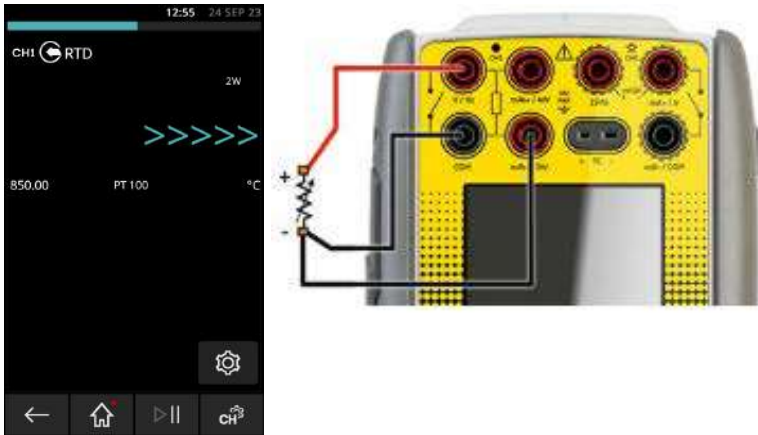

Figure 4-29: PT100 RTD Measure CH1 3-Wire (Range -200 to 850°C)

1. Set the applicable software options: **CH1**, Measure, RTD, Units.
2. Complete the electrical connections.
3. If necessary, change the RTD Type (default is PT100).

Select the **SETTINGS**  icon on the Dashboard, then tap **RTD TYPE** and select the type of RTD sensor.

Figure 4-30 shows a **CH1** set to measure a RTD by the use of a 2-wire cable.

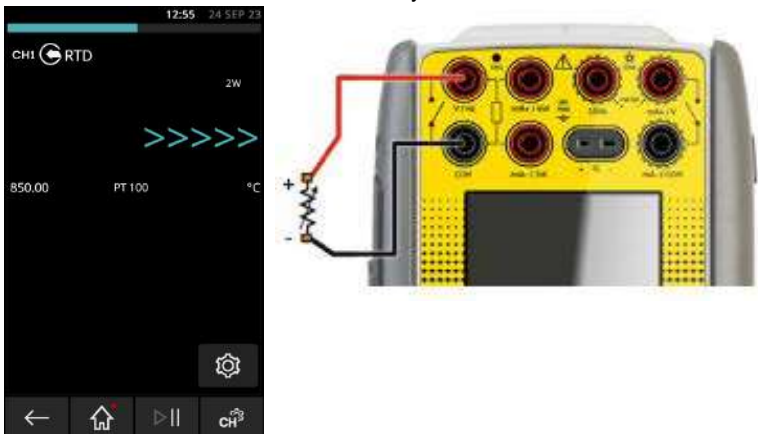



Figure 4-30: PT100 RTD Measure CH1 2-Wire (Range -200 to 850°C)

1. Set the applicable software options: **CH1**, Measure, RTD, Units.
2. Complete the electrical connections.
3. If necessary, change the RTD Type (default is PT100).

Select the **SETTINGS**  icon on the Dashboard, then tap **RTD TYPE** and select the type of RTD sensor.

4.10 Measure or Simulate a Thermocouple (TC)

4.10.1 DPI620G Measure or Simulate a Thermocouple (TC)

Figure 4-31 and Figure 4-32 show the **CH1** Setup to measure or simulate a TC temperature.

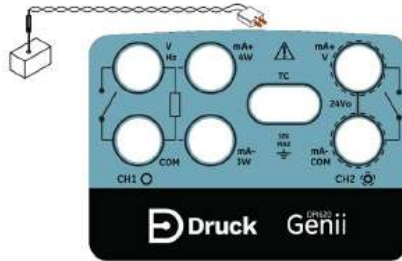

Figure 4-31: K-Type Thermocouple Measure CH1 (Range -270 to 1372°C)

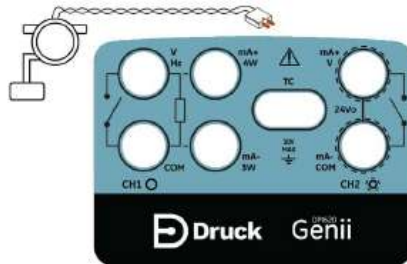

Figure 4-32: K-Type Thermocouple Source CH1 (Range -270 to 1372°C)

Note: Use the TC mV function to measure or simulate TC millivolts.

1. Set the applicable channel options.
2. Complete the electrical connections as shown.
3. If necessary, change the thermocouple type. Default is K-Type. On the Dashboard select

SETTINGS  > **TC TYPE**

4. Set **CJ (COLD JUNCTION) COMPENSATION MODE** i.e. choose between **Manual** and **Automatic** mode.

5. Set the **MANUAL CJ COMPENSATION** value if **Manual** mode has been selected in the previous step.

SETTINGS > MANUAL CJ COMPENSATION

If using an external cold junction, select check box on **MANUAL CJ COMPENSATION** and enter value for cold junction compensation temperature.

If you do not use **MANUAL CJ COMPENSATION**, the internal cold junction is used to calculate the thermocouple value.

6. To select **BURNOUT DETECTION**, tap the related check box if necessary, to put a tick mark ✓ in it.

4.10.2 DPI620G-IS Measure or Simulate a Thermocouple (TC)

Use the setups below to measure or simulate TC millivolts. In each situation, at the DPI620G-IS, select the TC mV function rather than TC.

Figure 4-31 and Figure 4-32 show the **CH1** Setup to measure or simulate a TC temperature.

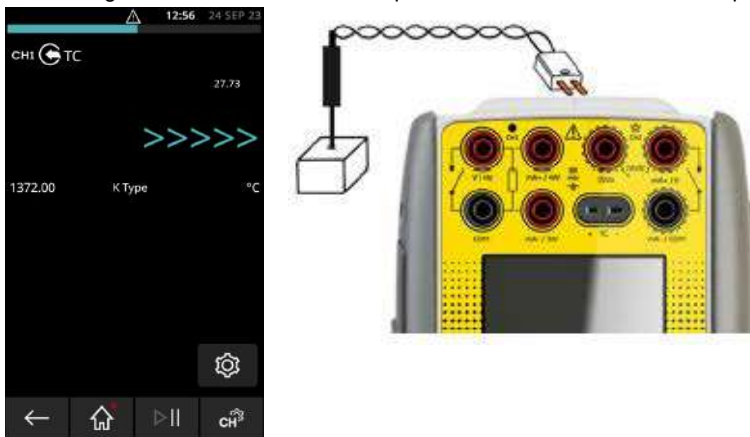

Figure 4-33: K-Type Thermocouple IS Measure CH1 (Range -270 to 1372°C)

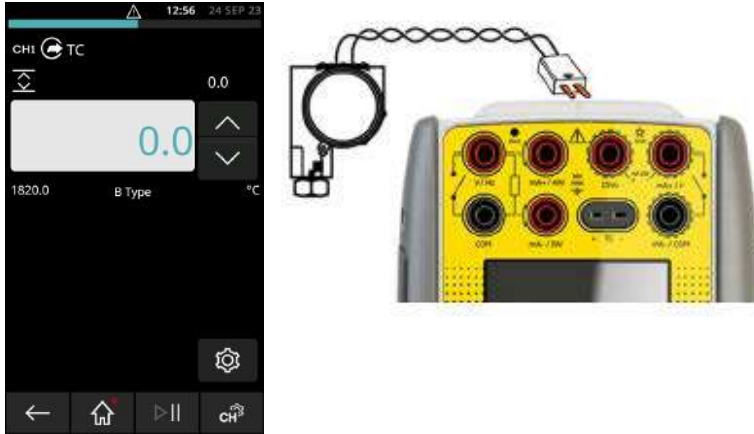

Figure 4-34: K-Type Thermocouple Source CH1 (Range -270 to 1372°C)

Note: Use the TC mV function to measure or simulate TC millivolts.

1. Set the applicable channel options.
2. Complete the electrical connections as shown.
3. If necessary, change the thermocouple type. Default is K-Type. On the Dashboard select

SETTINGS  **> TC TYPE**

4. Set CJ (Cold Junction) mode. Select **CJ MANUAL COMPENSATION** Mode.
If Manual CJ compensation is not selected, the internal cold junction is used to calculate the thermocouple value.
For an external cold junction, select the Check box on **MANUAL CJ COMPENSATION** and enter value for cold junction temperature.

4.11 Switch Test

When setting the **Switch Test** utility on any channel, the software automatically sets up the other channel for the switch connections.

- **CH1, P1, P2** and **IDOS/TERPS** functions use the **CH2** switch connections.
- **CH2** functions use the **CH1** switch connections.

Note: If there is a measure or source function on the switch connection channel it is automatically disabled. The display will show a screen message:

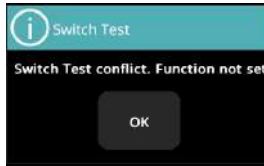

Figure 4-35: Switch Test Channel Conflict Message

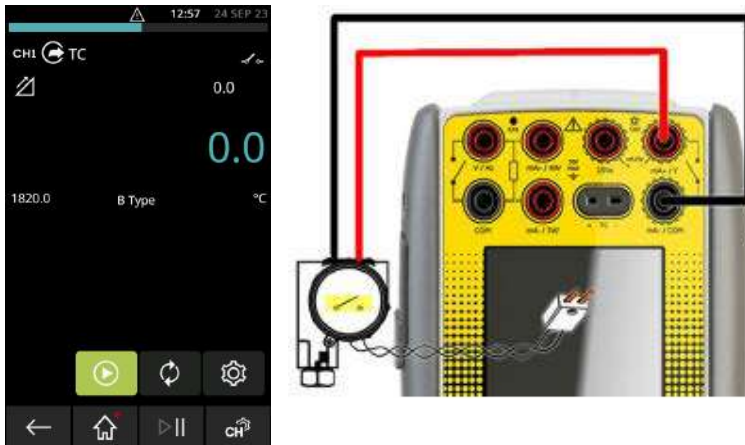



Figure 4-36: Thermocouple Switch Test

1. Set the applicable channel options:
 - The **TC** function is set to source a temperature.
 - The **UTILITY** is set to **SWITCH TEST**. The **AUTOMATION** is set to **RAMP**.
2. Complete the electrical connections.
3. **TC** is a **CH1** function, so the switch connections must be on **CH2**.
4. For the Ramp process, set **START** and **STOP** values that are applicable to the switch value.
5. To get an accurate switch value, set a long **TRAVEL** period.
6. Use  to start the Ramp cycle.
7. Use  to stop the Ramp cycle.
8. If necessary, supply the output values in the opposite direction until the switch changes condition again.

Chapter 4. Electrical Tasks

9. The display will show the following:

Opened at
Closed at
Hysteresis

- a. Value for switch Open point.
- b. Value for switch Close point.
- c. Hysteresis value.

To do the test again, tap the **Restart** icon .

5. Pressure Tasks

5.1 Introduction

This chapter gives examples of how to connect and use the instrument to measure pressure. This can be with the use of the module carrier (MC620G) and applicable pressure modules (PM620 or PM620T) or with the use of an external pressure sensor.



Figure 5-1: MC620G with PM620 Pressure Modules

To make a fully integrated pressure calibrator instrument with a Pressure Station (PV62X or PV624), refer to the related User Manual: Part No. 132M9253 for the PV62X Series or 174M7583 for the PV624.



Figure 5-2: DPI620G with MC620G Module Carrier and PM620 Pressure Modules



Figure 5-3: DPI620G with PV62X Pressure Station and PM620 Pressure Module



Figure 5-4: DPI620G with PV624 Pressure Station and PM620 Pressure Module

5.2 Module Carrier and PM620 / PM620T Pressure Modules



CAUTION To prevent damage to the PM620 or PM620T module, only use it within the specified pressure limit on the label.

This section shows the parts of the module carrier (MC620G) and pressure module (PM620 / PM620T). See Figure 5-5 below.



- 1 Pressure connection (G1/8 or 1/8 NPT) to attach external pressure equipment.
- 2 Pressure and electrical connections for a pressure module (PM620 / PM620T). These are self-sealing pressure connections.
- 3 Two screws to attach the calibrator (DPI620G).
- 4 Electrical connections for the calibrator (DPI620G).
- 5 Pressure module (PM620 / PM620T) with a pressure connection and reference port.

The PM620 / PM620T Label identifies:

- Sensor type (g: gauge, a: absolute)
- Pressure Range
- Serial Number
- Manufacturer



Figure 5-5: Pressure Module Carrier MC620G and PM620 / PM620T Pressure Module

When the items attach to the DPI620G it becomes a fully integrated pressure indicator, that measures pneumatic or hydraulic pressure.

5.2.1 Assembly Instructions



Figure 5-6: MC620G Assembly Procedure

1. Align the two slots (a) on the calibrator with the two posts (b) on the module carrier.
2. When the posts are fully engaged in the slots, tighten the two screws (2) hand tight.
3. Attach one or two PM620 / PM620T modules (4) with the correct range and type.
4. Tighten each PM620 / PM620T module (4) hand-tight only.
5. The   symbol flashes at the top of the screen, when the communication link between the PM620 / PM620T module and the calibrator occurs.

5.3 Pressure Connections



WARNING Pressurized gases and fluids are dangerous. Always safely release all the pressure, before attachment or disconnection of pressure equipment.

Use “Quick fit” pressure adapters on the pressure ports for external equipment. See Figure 5-7.



Figure 5-7: Quick Fit Pressure Adapter

1. Remove the adapter from the pressure port.
2. Use an applicable seal for the pressure connection:
 - a. NPT type: Use an applicable sealant on the thread.
 - b. BSP (parallel) type: Use the applicable bonded seal at the bottom.
 - c. BSP (parallel) type, 100 bar (1500 psi) or less: a bonded seal at the top is permitted.
3. Attach the adapter to the external equipment. If necessary, use an alternative adapter.
4. Tighten to the applicable torque.

5. Attach the adapter to the MC620G carrier and hand-tighten.

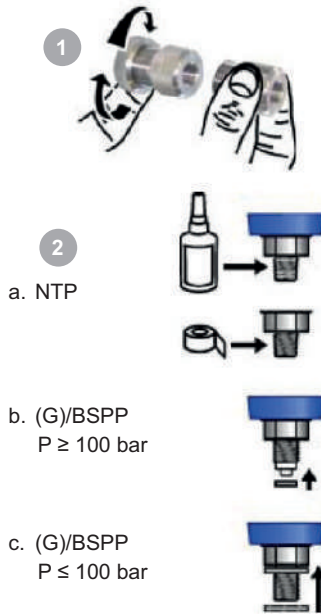

Figure 5-8: Pressure Connections

When the pressure indicator assembly is complete use the menus to set up the necessary operations. Refer to Section 3.3 and Section 3.3.1.

5.4 Measure Pressure – PM620 or PM620T

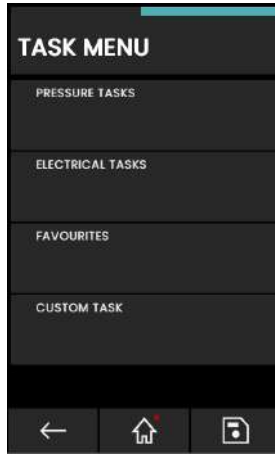

Figure 5-9: Task Menu

When PM620 / PM620T pressure modules are fitted or an external pressure sensor is connected, the Pressure Tasks option is displayed in the Task Menu. Refer to Section 3.3.1 for details.



Figure 5-10: Pressure Tasks

Select the required function by selecting on either the appropriate text or diagram. The DPI620G will set the functions and return to the Calibrator screen.

Pressure Functions can also be selected through the **CUSTOM TASK** function. Refer to Section 3.3.5 for details.

Tasks can be saved or copied into the **FAVOURITES**. Refer to Section 3.3.4 for details.

If required, change the **UNITS** or set a **UTILITY** for the function:

- Max/Min/Avg
- Switch Test
- Relief valve

- Leak Test



Figure 5-11: Channel Settings

Note: UNITS and UTILITIES are accessed by the selection of the function through CUSTOM TASK.

5.5 Measure Pressure – IDOS

Optional item - An IDOS Universal Pressure Module (UPM) uses Intelligent Digital Output Sensor (IDOS) technology to measure the applied pressure and supply the data to an IDOS instrument. Before you use an IDOS module, please refer to the user manual (K0378, Druck IDOS UPM).

Note: To attach an IDOS module to the DPI620G calibrator, use an IO620-IDOS-USB adapter.



Figure 5-12: IDOS Universal Pressure Module

5.5.1 IDOS Option Instructions

1. Attach one end of the adapter IO620-IDOS-USB to the IDOS module.
2. Push the type A end of USB cable into the USB socket on the instrument and the type B end into the adapter (IO620-IDOS-USB).
3. Power on the instrument.

4. When the IDOS  symbol flashes at the top of the display, it shows there is successful communication between the IDOS module and the calibrator.

5.5.2 IDOS Function Procedures

Set the applicable channel options:

1. On the external sensor channel , select IDOS function or any **IDOS** related option from the **Task** menu.
2. If necessary, change the Units for the function.
3. If necessary, set a Utility for the function i.e. **Max/Min/Avg**, **Switch Test** or **Leak Test**.
4. If required, change the Process settings for the IDOS function (**Tare**, **Alarm**, **Filter**, **Flow**, **Scaling**).
5. The zero procedure is the same for an IDOS module as for a PM620 / PM620T module. Zero a gauge sensor before use. See Section 5.8 for details on zero operation.

Note: These procedures and settings are the same for an IDOS module or for a MC620G / PM620 / PM620T assembly. After channel set up is complete, continue with the pressure set up in operation.

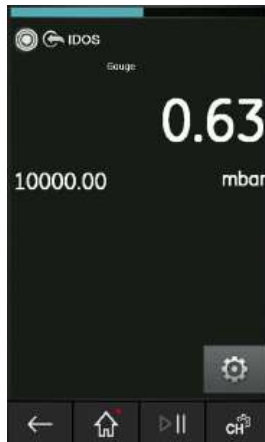

Figure 5-13: IDOS Pressure Measurement on External Sensor Channel

5.6 Measure Pressure – TERPS USB

TERPS (Trench Etched Resonant Pressure Sensor) UPM is a resonant silicon pressure sensor that gives high accuracy and high precision pressure measurement with a digital output. It can be used with the DPI620G using USB communication to increase the calibrator functionality.

Before using a TERPS module, please refer to the user manual (K0473, Druck TERPS 8000/8100/8200/8300 Series).

Note: To attach a TERPS module to the DPI620G calibrator, use a Micro-USB cable to connect the module to the DPI620G.



Figure 5-14: TERPS USB (UPM)

5.6.1 TERPS Option Instructions

1. Attach one end of the micro-USB cable to the TERPS module.
2. Push the other type A end of USB cable into the USB socket on the instrument.
3. Energize (power on) the instrument.

5.6.2 TERPS Function Procedures

Set the applicable channel options:

1. On the external sensor channel , select the TERPS function or any TERPS related option from the Task menu.
2. If necessary, change the Units for the function.
3. If necessary, set a Utility for the function i.e. Max/Mean/Min, Switch Test or Leak Test.
4. If required, change the Process settings for the TERPS function (Tare, Alarm, Filter, Flow, Scaling)
5. The zero procedure is the same for a TERPS module as for a PM620 / PM620T module. Zero a gauge sensor before use. See Section 5.8 for details on zero operation.

Note: These procedures and settings are the same for a TERPS module or for a MC620G / PM620 / PM620T assembly. After channel set up is complete, continue with the pressure operation.

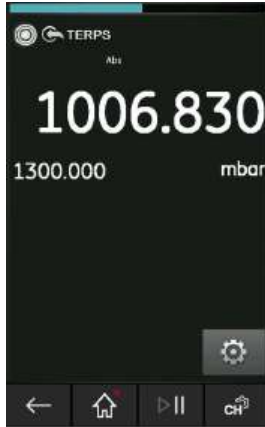





Figure 5-15: TERPS Pressure Measurement on External Sensor Channel

5.7 Leak Test

The Leak Test  utility is only available in pressure measurement modes. This utility makes available a test to calculate the pressure leak of a system.

To set a Leak Test:

1. Set the pressure channel Utility to **LEAK TEST**.
2. Select **SETTINGS**  and then **LEAK TEST**.
3. Set the following periods:
WAIT TIME: The time before the test starts in hours:minutes:seconds (hh:mm:ss).
TEST TIME: The period of the leak test in hours:minutes:seconds (hh:mm:ss).
4. Tap the  icon to start the Leak Test.
5. Tap the  icon to stop the Leak Test.

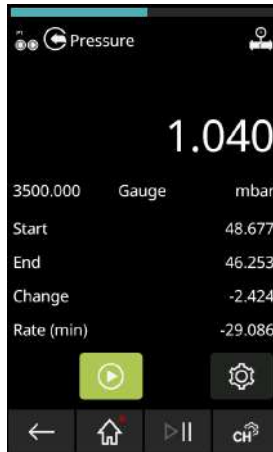



Figure 5-16: Example: Leak Test Results

Note: To set the Leak Test options, a pressure module or external pressure sensor must be correctly installed.

5.8 Set the Pressure Module to Zero

SETTINGS  > ZERO > ZERO

Use this option to write a new zero pressure value to the pressure module in use. The sensor zero adjustment is permitted only if the adjustment is less than 10% FS positive pressure value of the sensor.

Note: To make a temporary adjustment for zero, use the Tare function.

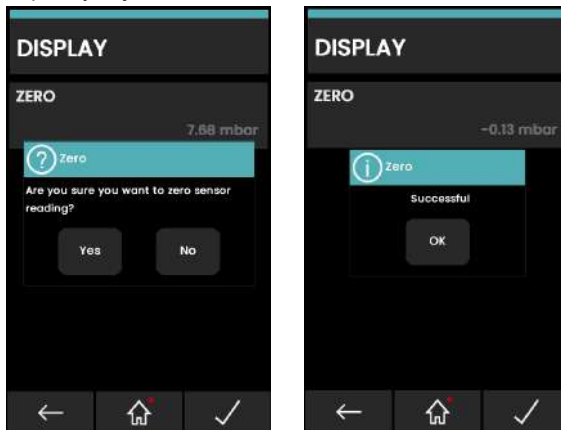

Figure 5-17: Pressure Module Zero Example

6. Temperature Tasks (RTD Interface)

The RTD-INTERFACE is a remote adapter interface for use with the DPI620G. This is to let a PT100 RTD probe to connect to the instrument, to measure temperature. The RTD-Interface can be supplied with a Druck 4-wire PT100 probe IO-RTD-PRB150.



Figure 6-1: RTD Probe and RTD-Interface

The **RTD-INTERFACE** is optionally supplied with a field-rewireable M12 connector for users to connect their own wire-ended RTDs. This is accessory part number IO-RTD-M12CON. The pin numbering is printed on the rear of the connector body.

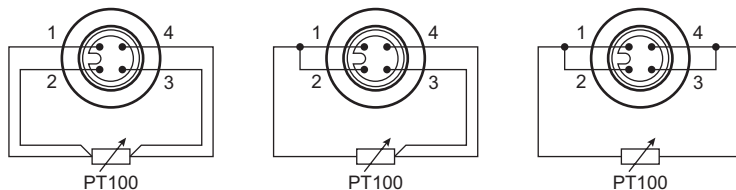





Figure 6-2: RTD M12 Connector Pinout

6.1 Setup

To use the **RTD-INTERFACE** option on the DPI620G, connect the remote RTD probe (IO-RTD-PRB150 or user-owned) to the RTD-INTERFACE adapter. Then connect the RS 485 end of the RS485-USB adapter cable (IO-RTD-USBCABLE) to the RTD-INTERFACE and the USB-A end to the USB-A port on the DPI620G.

The procedure to set up a RTD sensor is:

1. Tap the **Calibrator**  icon on the Dashboard.
2. The channel screen must show the **External Sensor**  menu row. If it does not, tap the **CHANNEL SETTINGS**  icon to show the **TASK MENU** screen.
3. Tap the **CUSTOM TASK** menu row to show the **TASK SETTINGS** screen.
4. Tap the **External Sensor**  menu row to show the first **CHANNEL SETTINGS** screen.

- Tap on the **FUNCTION** menu row option to show the related **CHANNEL SETTINGS** screen, Figure 6-3 below, to show a list of the available functions for the channel. Tap on **RTD-INTERFACE** at the bottom of the list.

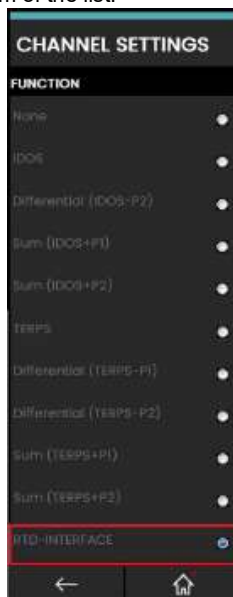

Figure 6-3: CHANNEL SETTINGS screen - available FUNCTIONS

- The **CHANNEL SETTINGS** screen changes and shows that the **RTD-INTERFACE** is selected.



Figure 6-4: Example: CHANNEL SEETTINGS for RTD-INTERFACE

- Tap the **Tick** ✓ icon on the screen to show the **TASK SETTINGS** screen and then tap the **Tick** icon on that screen to show the **Calibrator Channels** screen.

6.2 Utilities

The only available UTILITY with the **RTD-INTERFACE** option is **Max/Min/Mean**.

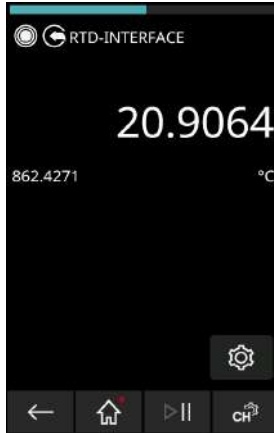



Figure 6-5: Example: RTD-INTERFACE on External Sensor Channel

6.3 Settings

The **RTD-INTERFACE** function can be configured by tapping the **SETTINGS**  icon which shows the following:

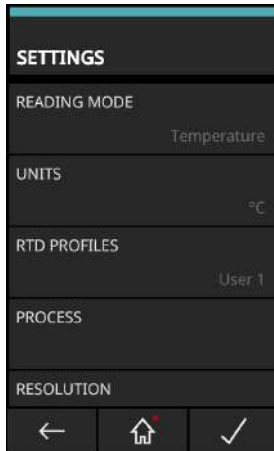

Figure 6-6: RTD-Interface Settings

- **READING MODE**
Allows the temperature measurement to be shown as:
 - a. Temperature (°C or °F)
 - b. Resistance (Ohms).
- **UNITS**
Allows change of units depending on the Reading Mode selected.

- **RTD PROFILES**

Based on the Callendar-Van Dusen equation, the coefficients required for the RTD curve can be selected using a set profile.

There are two standard default profile options available which cannot be edited. These are the "Default US" and the "Default EU".

6.4 User Profiles

There are up to ten customizable User Profiles which can be edited to suit the requirement.

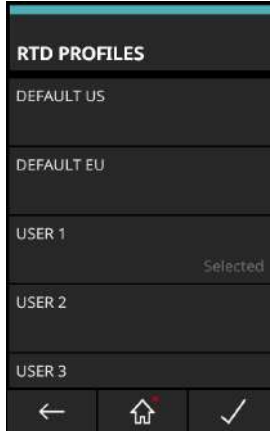

Figure 6-7: RTD Profile Selection

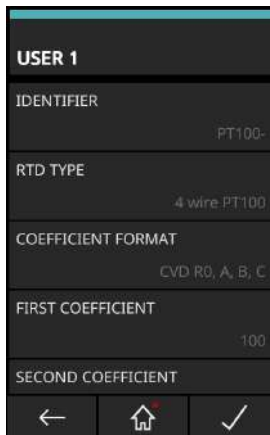

Figure 6-8: RTD Profile Set Up

7. Test Procedures

7.1 Downloaded Procedures









To use the **DOWNLOADED PROCEDURES** function, you first download a calibration procedure made by the 4Sight2™ software. The 4Sight2™ calibration procedure has all the values necessary to calibrate a device under test (for example, test points, ramp time and others).

Tap **TEST PROCEDURES** on the Dashboard to access the **Downloaded Procedures** function.

The same calibration procedure is available for use on all the applicable devices under test. To use the **Downloaded Procedure** function, you must have a copy of the 4Sight2™ Calibration Software and a USB lead: mini USB type B (DPI620G) to USB type A (PC).

The 4Sight2™ calibration software makes available the DPI620G calibrator device driver.

7.1.1 Sequence to Upload and Download File

1. Make sure the DPI620G USB is in its **Communications** mode. See Section 2.4.4, “SETTINGS - CONNECTION,” on page 28.
2. Connect a USB lead to the mini USB type B port on the DPI620G calibrator.
3. Connect the other end of the USB lead to a USB type A port on the computer that has the 4Sight2™ Calibration Software installed.
4. Use 4Sight2™ to make the procedure and make a work order for the device.
5. The procedure includes the parameters for the calibration, the number of test points, the relationship and pass/fail tolerance.
6. Use the **Download** icon in 4Sight2™ to download the file to the DPI620G calibrator. A communications symbol will be at the bottom of the screen.
7. Select **DOWNLOADED PROCEDURES** from the **Documenting** menu.
8. In the **Procedures** window, select the filename specified in 4Sight2™.
9. Enter/check the **User ID** and the **DUT Serial Number**. The ambient environmental parameters can also be changed.
10. Tap the **Next** icon to continue: at this time the calibrator screen shows the Warning notes and Pre-calibration notes.
11. Tap on the **Start**  icon. The procedure sets up the necessary Channel options (for example, Current (mA), Voltage (Volts)).
12. Use the **Take Reading**  icon at each set point specified by the procedure. A prompt message shows when each point occurs and for a reading to be done.
13. When all the measurements have been done, tap the **tick** icon  to complete the calibration.
14. Look at **Post Calibration Notes**, enter any **Calibration Remarks**. Select the **Next**  icon.
15. Look at the **Results** overview and tap the **Save**  icon to save the results.
16. Look at the results on the display (**As found/As Left**).
17. Redo the test if necessary: tap the **Start**  icon then the **Analysis**  mode or tap the **Home**  icon to exit.
18. To complete the process, use the Calibrator Manager to load the file back into the 4Sight2™ database.

7.2 Calibration Wizard

A Calibration Wizard gives screens that show the necessary parameters for different calibration procedures. After you enter all the parameter values into a procedure screen, you can save the full procedure file in the DPI620G memory. To do a calibration you select this file and tell the DPI620G to do the calibration.

7.2.1 How to access the Calibration Wizard

1. Tap the **TEST PROCEDURES**  icon on the Dashboard.
2. Tap the **CALIBRATION WIZARD** menu row on the **TEST PROCEDURES** screen.

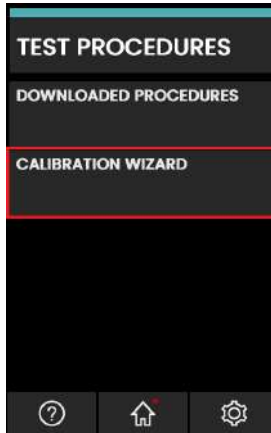

Figure 7-1: TEST PROCEDURES screen

3. The display will show an empty **PROCEDURES** screen the first time you use the device. If there were procedures available they would be on the screen and you can select them.

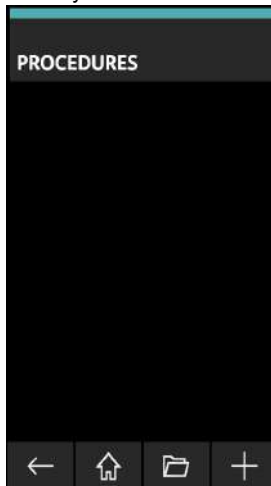







Figure 7-2: PROCEDURES screen



Chapter 7. Test Procedures

There are four icons at the bottom of the screen:

	Show previous screen
	Show Dashboard Home screen
	File Manager
	Make file name

Tap the **File Manager**  icon to show the **PROCEDURE FILES** screen. Use this screen to manage calibration procedure files. For example: to make a copy of a procedure file, give different values to the parameters in this file, and then save this file with a new name. Unwanted procedure files can also be deleted. Procedure files can be transferred to storage devices. For example, to the internal SD memory card or to an external USB memory stick. The files are in the Comma Separated Variable (*.csv) format that can be read by MS Excel and other spreadsheet applications.

7.2.2 How to make a procedure

1. Tap the  icon at the bottom of the **PROCEDURES** screen and enter a new filename. For example, "MA". Tap the  icon to enter the filename and show the next screen.

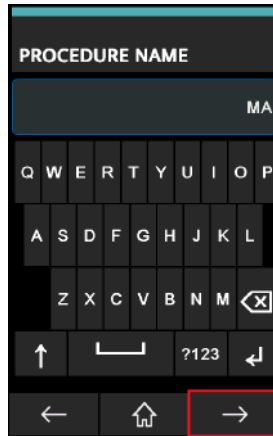
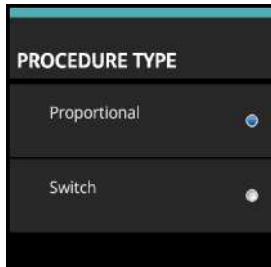
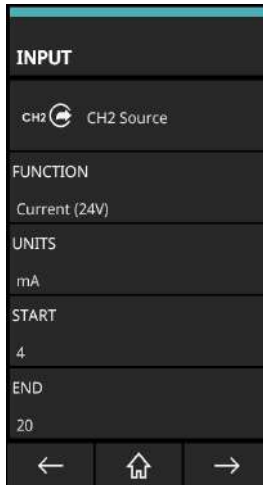

Figure 7-3: Procedure Name screen

- The display shows the **PROCEDURE TYPE** screen. Tap on the related menu row to select either **Proportional** or **Switch**. A Proportional relationship is when there is a mathematical relationship between the Reference Input and the Measured Output. The function of a Switch test is to sense if the switch operates at a specified input value. A record of the result can be made.



- The display shows the **INPUT** parameters screen. If necessary, tap on a menu row to select it and change its value by the use of either a related onscreen keyboard or menu radio button.



The **START** and **END** values specify the measurement range for input (the Low and High value for the channel): the default values are usually the negative and positive full-scale values of the function. When the screen shows the wanted parameter values, tap on the

 icon to show the **TEST POINTS** screen.

Chapter 7. Test Procedures

4. On the **TEST POINTS** screen, if necessary, tap on a menu row and then change the value of its related parameter.



Test Points are input points at which the DUT is examined and its calibration data recorded. POINTS **UP** is the measurement direction for the number of points from the **START** range value to the **END** range value. POINTS **DOWN** is the measurement direction for the number of points from the **END** range value to the **START** range value. A default of 2 **UP** points and 0 **DOWN** points (Two test points) is always available. The first test point is the Input Start Value and the second is the Input End Value.

The **Test Points** screen lets each test point be manually adjusted.

You can use either the **Linearity** or **Square Root** function. **Linearity** is the default setting. Use the **Square Root** function for pressure transmitters that measure fluid flow.

TEST POINT TOLERANCE is the maximum deviation of permissible error margin for each input test point in the calibration. The default value is 5%.

When the screen shows the wanted parameter values, tap on the  icon to show the **OUTPUT** screen.

- On the **OUTPUT** screen, if necessary, tap on the menu row and change the related parameter value.



OUTPUT relates to the output signal from the Device Under Test (DUT). When the screen shows the wanted parameter values, tap on the **→** icon to show the **TOLERANCE** screen.

- On the **TOLERANCE** screen, if necessary, tap on the menu row and change the related parameter value.

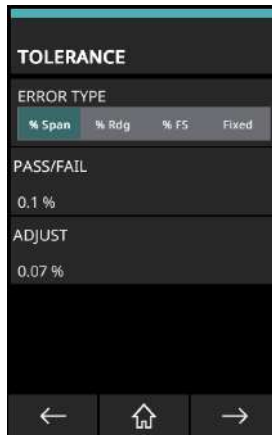

These **ERROR TYPE** options are available for setting the error or deviation from the transfer characteristic:

- % Span** is a percentage of the Output signal span
- % Rdg** is a percentage of the Output signal reading
- % FS** is a percentage of the Output signal Full-Scale
- Fixed** is the absolute measurement units of the Output signal.

Chapter 7. Test Procedures

The PASS/FAIL value is the tolerance or test limit values for the calculated result error or deviation from the transfer characteristic. The tolerance value is either a percentage (%) or as an absolute or fixed measurement unit e.g., mA. This is specified by the Error type you select.

The **ADJUST** value sets the percentage deviation from the maximum and minimum limits of measurement. This percentage sets the value, which, when exceeded, warns you that an adjustment is necessary to keep values in the tolerance limits.

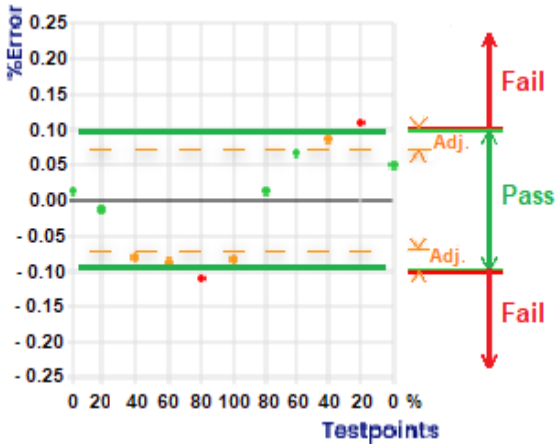



When the screen shows the wanted parameter values, tap the  icon to show the summary screen that shows important parameter values for **INPUT**, **OUTPUT**, **TEST POINTS** and **TOLERANCE** for the procedure. In this example, the "MA" procedure.

7. Save the new procedure. Tap the **SAVE**  icon to put the test procedure file into the DPI620G memory.

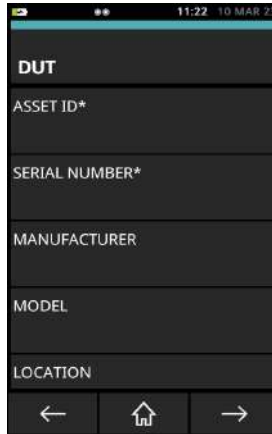
- The test procedure is in the device memory. This procedure must be linked to the Device Under Test (**DUT**) and the environment in which the device test occurs. To do this, tap the **PLAY**  icon to show the **DUT** (Device Under Test) screen.



- Tap a menu row and enter data for the menu item. Tap the **tick**  icon to enter the data into the DPI620G memory and show the **DUT** screen again. The menu rows with an asterisk * are mandatory and thus must have data.

Tap the  icon to show the **ENVIRONMENT** screen.

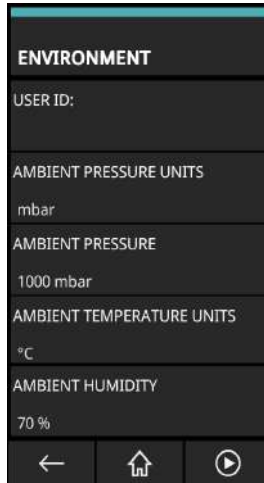

When you have entered all the necessary data tap the **PLAY**  icon: the display will show the test channel screen.

Chapter 7. Test Procedures

- The test channel screen will have a message that tells you to connect the device under test to the DPI620G. Connect the DUT and tap the **OK** button in the window. The DPI620G will use the selected procedure to test the device.



7.3 Example Test

This example test uses a RTD sensor as the DUT. The test procedure file is "Temp mA".

7.3.1 Select the test procedure.

- Tap the **TEST PROCEDURES**  icon on the Dashboard.
- Tap the **CALIBRATION WIZARD** menu row on the **TEST PROCEDURES** screen.
- Select the test procedure from the **PROCEDURES** screen: tap the **Temp mA** menu row.



4. The display shows a screen of a summary of the parameters for the selected test procedure.

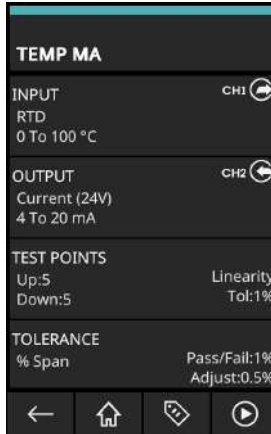

The **DUT** icon  shows a list of DUT (Device Under Test) assets that have related test procedure files in the device storage.

Tap the **PLAY**  icon to show the **DUT** screen.

5. Tap on the **ASSET ID*** menu row and use the onscreen keyboard to enter the ID data. Tap on the keys and the **tick**  icon to enter all the data. Tap on the **SERIAL NUMBER*** menu row and use the onscreen keyboard to enter the SERIAL NUMBER data. Both these fields have mandatory data and thus must have data entered.

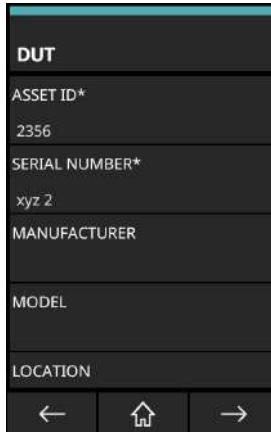

Tap the **Proceed**  icon to show the **ENVIRONMENT** screen.

Chapter 7. Test Procedures

6. Change parameter values if necessary: tap on the related menu row and change the value by the use of an onscreen keyboard or menu radio button.

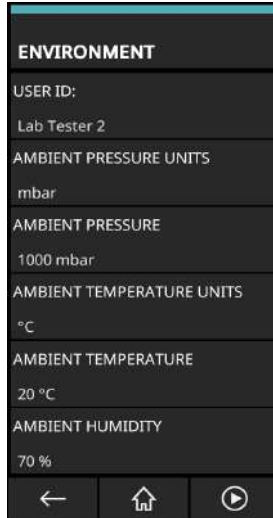



Tap the **Play**  icon to execute the test procedure.

7. The display shows a screen message “CONNECT DUT”.



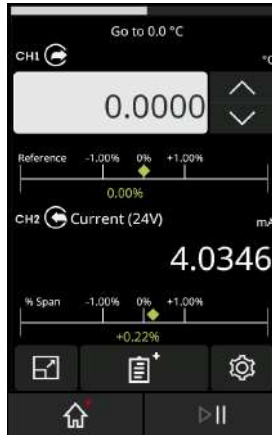

Push the DUT plug connections into their related sockets at the top of the DPI620G face. Tap the **OK** button on the screen to show the test process screen.

- Tap the **Enter Test Point data**  icon to start the test. Wait for a measurement value to move at the bottom of the screen when the system seeks the set point value. This measurement value will change color as it moves. When the value is out of range the value will be red. When the value is orange an adjustment can be possible. When this value is yellow the value is in the set limits. Tap the **Enter Test Point data**  icon when the value becomes stable: this makes a record of the value and moves to the next point.

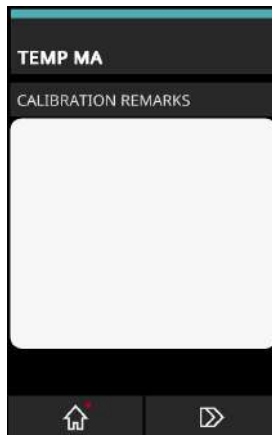

- When the test points have all been tested the screen will show a tick arrow  icon. Tap this icon to accept the test results. The display will show the **CALIBRATION COMMENT** screen.
- You can enter comments about the test. Tap on the white comment area to enter comments if wanted.





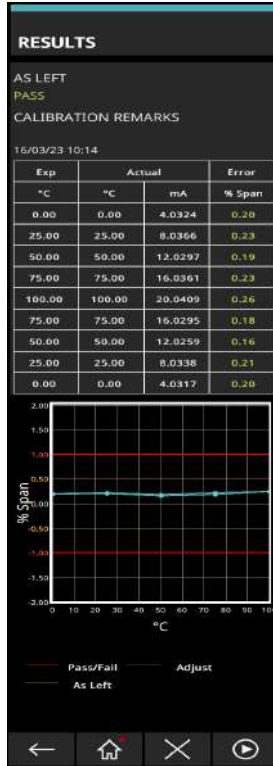

- Tap the proceed  icon at the bottom of the screen to show the **RESULTS** screen.

Chapter 7. Test Procedures

12. The test results are shown in the form of a table and a graph. Swipe your finger up the screen to show all the table and a graph of the results at the bottom of the screen.



13. Tap the **Move Back**  icon to show the previous screen.
- Tap the **Home**  icon to show the Home screen.
- Tap the **Exit**  icon to cancel the operation of the test procedure.
- Tap the **Play**  icon to go to the screen for a new test.

8. Documenting

This chapter gives the Documenting functions available with the DPI620G calibrator. These are:

- ANALYSIS
- DATA LOGGING.

8.1 Analysis

The **ANALYSIS** function calibrates the transfer characteristic of the device and takes measurements from two or more channels for this function. One channel is the Reference channel and the other channel is the Input channel.

Use the **Reference** channel:

- To show the measurement of the input signal to the device.
- For the calibration of a temperature transmitter, the Reference channel can be **CH1** in either **RTD** or **TC** source mode.
- When the device is a pressure transmitter, the Reference channel can be **P1** or **P2** for the measurement of the input pressure to the device or an external pressure channel e.g. IDOS.

Use the **Input** channel:

- For the measurement of the output signal from the device.
- For the calibration of a 4 to 20mA process transmitter, the channel can be **CH2** in **Current Measure** mode.

A second input channel is also available for the calculation of the transfer characteristic between three points in the signal path. This can be calibrated at the same time, as in the example that follows.



When calibrating a process transmitter that uses the HART® communication protocol, the second input channel can be the HART® channel. The HART® channel reads the Primary Variable (PV) value from the sensor in the process transmitter. This lets calibration of the pressure sensor be done at the same time as the current loop output.

A channel in operation, that is not specified as Reference, is an Input channel by default.

There must be one Reference channel and at least one Input channel specified, for the Analysis function to operate.

At each test point value, the Analysis function calculates the difference of each Input channel to the ideal transfer characteristic and compares this to a tolerance limit.

This deviation is calculated and displayed as **%Span** or **%Reading**.

The tolerance test result is shown as a **Pass**  or **Fail**  icon.

8.1.1 Setup

1. Set the DPI620G channels in the Calibrator function. Refer to Section 3.
2. Connect the calibrator to the device under test.
3. Tap the **Documenting** icon  on the Dashboard to make available the **Documenting** function.
4. Select **ANALYSIS**.

8.1.2 Define Reference Channel

1. Tap on a **CHANNEL** row to let you select the Reference channel for the analysis.

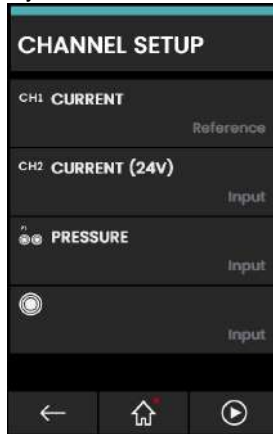

Figure 8-1: Select Reference Channel

2. Set the necessary channel type to **Reference**.
3. All the other channel settings for this **Reference** channel will not be available. All other channels available for use are automatically set as Input channel(s).

8.1.3 Define Input Channel(s)

Tap each Input channel icon to set the Input options.

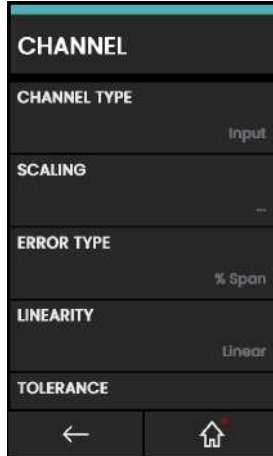

Figure 8-2: Select Input Options

- **SCALING**

The scaling values are four set values:

- a. The maximum and minimum Reference signal values (**Reference High** and **Reference Low**).
- b. The Input signal values (**Input High** and **Input Low**).

The Input signals are Reference signal values with a linear or square root transfer characteristic.

- **ERROR TYPE**

This is the deviation from which the transfer characteristic is calculated. This can be one of these options:

- a. **% Span** - a percentage of the Input signal span.
- b. **% Rdg** - a percentage of the Input signal reading.

- **LINEARITY**

This is the transfer characteristic from Reference to Input signal. Select from these options:

- a. Linear - a proportional response.
- b. Square Root - often found in flow sensors.

- **TOLERANCE**

This gives test limits for the deviation from the transfer characteristic.

8.1.4 Analysis Function

Set Reference channel and Input channel parameters (refer to Section 8.1.2 and Section 8.1.3), and return to the **CHANNEL SETUP** screen.

Select the **Start**  icon.

The Analysis window shows the following:

- The deviation of each Input channel from the ideal transfer characteristic.
- A tolerance limit test icon

Pass  (within tolerance test limit)

Fail  (outside tolerance test limit)

To examine the full range of the device:

1. Move the Reference signal value in steps through its range.
2. Examine the Analysis window at each step.
3. If the Reference is sourced from the calibrator, maximize the channel window to change the Reference value.
4. Go to the **ANALYSIS** window.
5. When the analysis is complete select the  icon to close the window.

8.2 Data Logging

Tap in the **DATA LOGGING** menu row on the Dashboard. The **DATA LOGGING** function records instrument readings so they can be examined or analyzed.

This chapter gives instructions for how to use the **DATA LOGGING** function to log data to a file.

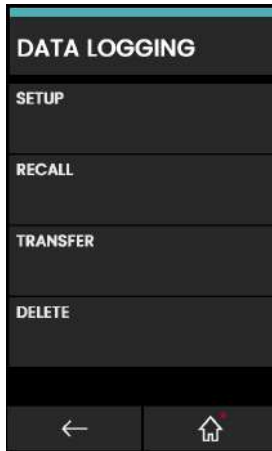

Figure 8-3: Data Logging

In the **DATA LOGGING** mode the screen data from all active channels is put into memory at each data point.

The data can be stored:

- a. Periodically or by
- b. Key Press.

The data is put into the internal memory or on a USB Flash Drive connected to the instrument until the Data Logging is stopped.

8.2.1 Setup

To begin a data logging session, make sure all relevant channels are set to the correct functions, refer to Section 3. Tap the **SETUP** menu row to show the Data logging **SETUP** menu.

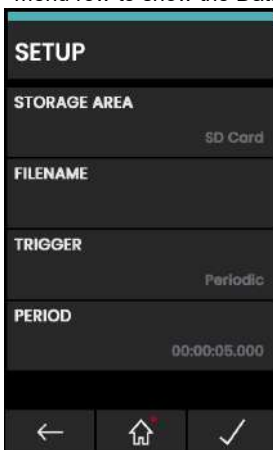



Figure 8-4: Data Logging Setup

- **STORAGE AREA**
Used to set Internal, SD card or external USB Flash Drive if connected. Only the SD card can be read when connected to a PC.
- **FILENAME**
Enter the required filename (10 characters maximum).
- **TRIGGER**
Select one of the following:
 - a. **Key Press** (logs one data point each time the icon is tapped).
 - b. **Periodic** (logs one data point at a set time interval).
- **PERIOD**
Use this option to set the time interval for periodic data logging.
To start Data Logging Mode:
 1. Select the appropriate options and enter a filename for Data Log file.
Note: When you enter the filename you must select the destination (INTERNAL, SD Card or USB FLASH DRIVE)
 2. Select the  icon.

8.2.2 Operation

If in periodic mode, to begin data logging tap the **Start logging**  icon.

In **Key Press** mode, tap the **Log** icon  to log a data point.

In **Data Logging** mode, the display data from all active channels is put into memory at each data point.

To stop data logging when necessary, tap the **Cancel**  icon.

Chapter 8. Documenting

The data logging indicator ● flashes on the status bar to show that a reading is logged.

The data is stored in the internal memory, SD card, or external USB Flash Drive if connected, until the Data logging is stopped.

8.2.3 File Review

To look at saved Data log files select **RECALL** from the **DATA LOGGING** menu (see Figure 8-3 on page 102).

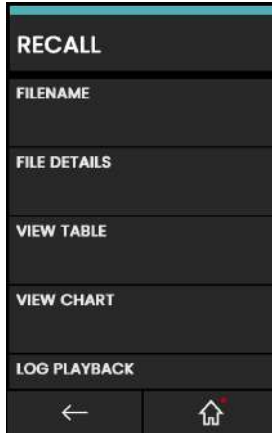

Figure 8-5: Data Log File Menu

To see a summary of the Data log file:

1. Tap on **FILENAME** to display the list of data files.
2. Select the file to be shown.
3. Select **FILE DETAILS** to look at the date/time stamp and the total number of data points logged to that file.

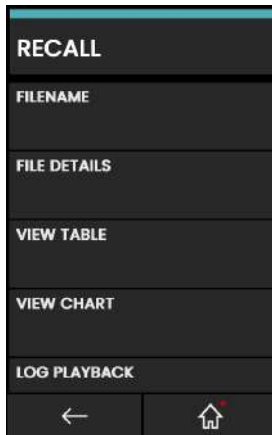



Figure 8-6: Data Log File Details

To look at a data file as a table:

1. Tap on **FILENAME** to show the list of data files.

2. Select the wanted file.
3. Tap **VIEW TABLE** to see the data in table format.
4. Tap the **Next**  icon to move to the next page of data points if applicable.
5. To go back a page, tap the **Previous**  icon.



25 Oct 2016		
Time	Points	CHI V
13:58:47	1	10.033
13:59:52	2	10.033
13:59:57	3	10.033
14:00:02	4	10.033
14:00:17	5	10.033
14:00:22	6	10.033
14:00:27	7	10.033
14:00:32	8	10.033

Figure 8-7: Data Log Table

To see the contents of a data file in a chart:

1. Tap the **FILENAME** menu bar to show the list of data files.
2. Select the file to be shown.
3. Select **VIEW CHART**.

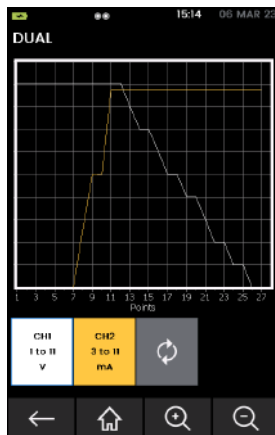









Figure 8-8: Data Log Chart

Tap the **Zoom In**  icon to increase the size of the graph or **Zoom Out**  icon to decrease the size on the graph. Tap the **Refresh**  icon to show all graph lines on the

display. Tap the **Channel**  or  icon to show or hide the related graph line on the screen.

To look at a data file configured on the instrument during the initial data log session:

1. Tap the **FILENAME** icon to display the list of data files.
2. Select the wanted file.
3. Select **LOG PLAYBACK**.
4. Use the **Next**  icon to move to the next data point and the **Previous**  icon to move back to the previous data point.

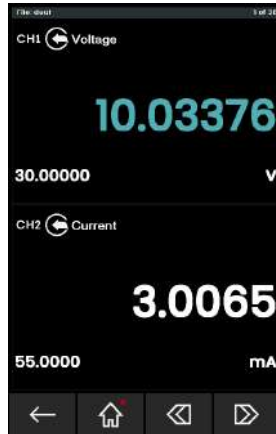

Figure 8-9: Data Log Play Back

8.2.4 Data Log File Management

The data log file management options are as follows:

- **TRANSFER**
Upload data log files to another device or computer to be processed externally.
- **DELETE**
Erase data log files.

8.2.4.1 Transfer

Use the following values to move Data:

- USB Flash Drive: Selected files are written in the root folder of the USB Flash Drive.
- SD card: Data logged in an internal storage area can be moved to the SD card storage area.
- USB Serial Port: Moves data as a text file to a computer. A communications program can be used to receive the data (e.g. Microsoft® Hyper Terminal). The serial Setup is as follows:

Parameter	Value
Baud rate:	19,200 bits/sec
Data bits:	8
Parity:	none
Stop bits:	1

8.2.4.2 DELETE

Data may be deleted by selecting the **DELETE** option from the **DATA LOGGING** menu.

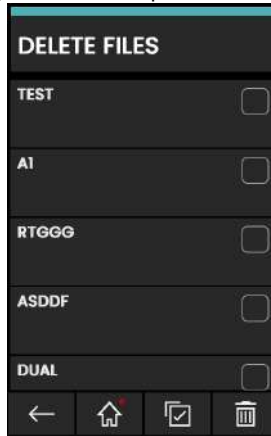





Figure 8-10: Delete Data Log Files

- **DELETE ONE FILE**

Tap the tick box of the file to be deleted and tap the **Delete**  icon to delete the selected file.

- **CLEAR INTERNAL**

To clear all files, tap the **Select All**  icon, then tap the **Delete**  icon to delete all the selected files.

Chapter 8. Documenting

8.2.4.3 Data Format

The data files are in a Comma Separated Variable (csv) format (See Figure 8-11). This lets the data be imported into a spreadsheet (e.g. Microsoft® Excel). The first section of the data file has:

Field	Description
FILENAME	The data file name.
COLUMNS	Information for internal use.
START	Data log start time.
VERSION	Data format version.
CHANNEL	The function setting of each active channel.

The second section of the data file has:

- Individual headings.
- Data point data.

```
FILENAME,1234567890
COLUMNS,3,14
START,10 Aug 2021, 10:00:00
VERSION,3
CHANNEL 0,Current,Out,mA,24
CHANNEL 1,Current (24V),In,mA,55
DATA,START
ID,Date,Time,Main Reading,Units,Caption,Main Reading,Units,Caption
0, 10 Aug 2021, 10:00:00, 4.000, mA, Current, 4.0013, mA, Current (24V)
1, 10 Aug 2021, 10:00:05, 5.499, mA, Current, 5.2774, mA, Current (24V)
2, 10 Aug 2021, 10:00:10, 8.117, mA, Current, 7.9861, mA, Current (24V)
3, 10 Aug 2021, 10:00:15, 10.841, mA, Current, 10.4681, mA, Current (24V)
4, 10 Aug 2021, 10:00:20, 13.519, mA, Current, 13.0331, mA, Current (24V)
5, 10 Aug 2021, 10:00:25, 16.213, mA, Current, 15.8164, mA, Current (24V)
6, 10 Aug 2021, 10:00:30, 18.919, mA, Current, 18.3990, mA, Current (24V)
7, 10 Aug 2021, 10:00:35, 20.000, mA, Current, 20.0065, mA, Current (24V)
8, 10 Aug 2021, 10:00:40, 18.599, mA, Current, 19.0423, mA, Current (24V)
9, 10 Aug 2021, 10:00:45, 15.888, mA, Current, 16.4401, mA, Current (24V)
10, 10 Aug 2021, 10:00:50, 13.191, mA, Current, 13.6680, mA, Current (24V)
11, 10 Aug 2021, 10:00:55, 10.472, mA, Current, 10.7516, mA, Current (24V)
12, 10 Aug 2021, 10:01:00, 7.777, mA, Current, 8.1810, mA, Current (24V)
13, 10 Aug 2021, 10:01:05, 5.164, mA, Current, 5.4783, mA, Current (24V)
14, 10 Aug 2021, 10:01:10, 4.000, mA, Current, 4.0016, mA, Current (24V)
```

Figure 8-11: Example 'csv' Data log File

9. HART® Operations

The DPI620G can work with devices that use the HART protocol:

- The Universal and Common Practice instructions specified in HART versions 5 to 7.
- Devices that use Device Descriptions (DD).

This chapter has procedures for how to use the HART functions available in the calibrator.

The instructions for the use of HART in the DPI620G-IS are at the end of this chapter. See Section 9.11 on page 130.

9.1 HART® Menu Operations



The HART protocol uses a digital signal mixed with a standard 4 - 20mA current loop, to transmit data to and from a field device that uses HART communication. Typical operations are:

- Read the primary variable and the analog output.
- Read the device serial number, type and supplier.
- Get calibration data from memory (upper and lower range values, sensor limits, calibration date).
- Do status and fault-finding checks.
- Change the device setup (range, units, damping).

You can use the DPI620G as an interface with other HART field devices:

- As a Primary Master. The DPI620G starts and controls all transmitted signals. The field device (slave) uses each command from the master device to make a change and/or send data back.
- As a Secondary Master. The DPI620G connects to a HART network. The Secondary Master controls signals with the field device in between Primary Master messages.

9.2 Start-up

Tap the **COMMUNICATOR**  icon on the Dashboard and then tap the **HART HART**  icon on the Dashboard to start the HART control of signals.

Tasks can be selected for **CH1**, **CH2**, **P1**, **P2** and external sensor. Refer to Chapter 3.

You can also select HART from the **TASK MENU** screen. Tap the **CUSTOM TASK** menu row and then tap the **HART** row if it is available on the screen.

9.3 HART® Connections

Before the electrical connections between the HART device and the DPI620G are set, select the correct connection scheme (Refer to **DASHBOARD > HELP**). Refer to Chapter 9.11 on page 130 for information that relates to the DPI620G-IS equivalents.

9.3.1 Power Supply from the Calibrator

A 24V or 28V loop power can be supplied to the HART device: use the **CH2 Current** (24V or 28V) measure function.

Chapter 9. HART® Operations

In this example the Druck DPI620G supplies the loop power and a 250Ω HART® resistor.

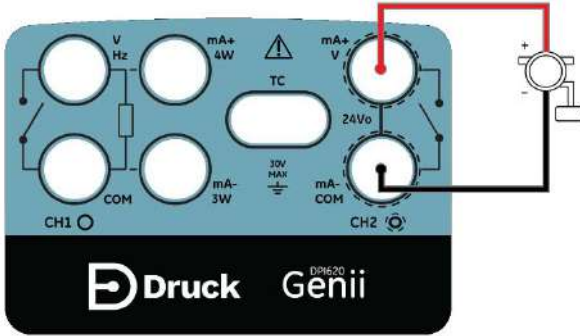

Figure 9-1: HART Device Connection with Loop Power

9.3.2 External Loop Power

In this example there is an external power supply. Measure current on **CH2** without 24V loop power.

The HART function is started and 250Ω resistor is made available.

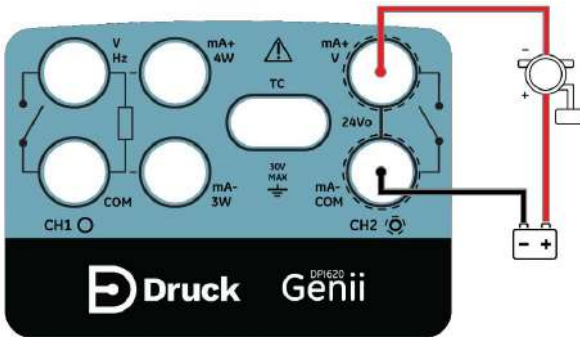

Figure 9-2: HART Device Connection on CH2

9.3.3 Communicator Attached to a Network

In this example the calibrator connects directly to a network. There must be a 250Ω resistor in series with the loop power supply and the HART device.

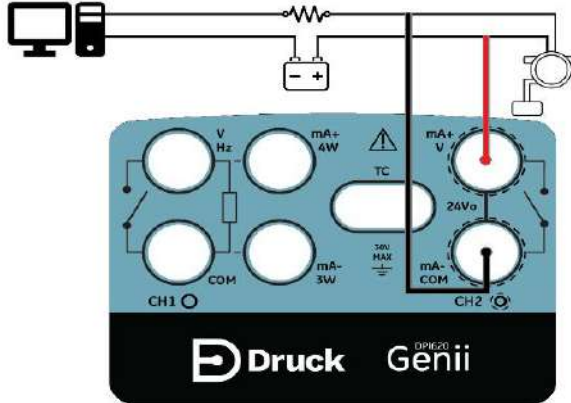

Figure 9-3: HART Communicator Network Connection

CH2 function is set to **None**. The HART function is made available on the HART channel with the 250Ω resistor set to Off.

9.3.4 Use of Test Connections

To use the test connection on a HART transmitter: use **CH1** to measure current and **CH2** as the signal interface with the HART device. The **CH2** function must be set to **None**, and the **CH1** function must be put into **Current Measure** mode. There must be an external HART resistor in the loop.

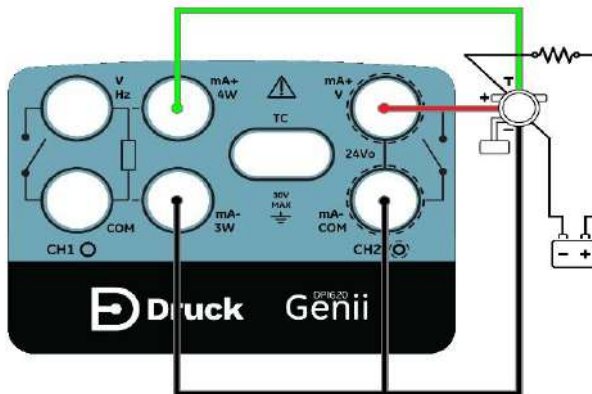

Figure 9-4: HART Device Test Connections

9.4 How to see HART® Primary Variables

When connected to a HART device, the channel window will show the **Primary Variable (PV)** value and PV units.



Figure 9-5: HART® Primary Variables

Do the device connection setup if there is no HART connection and the PV is not shown.

You can connect the HART device in one of two HART modes:

1. **OFFLINE**
2. **ONLINE** (SDC Application).

9.5 HART® Offline

9.5.1 Introduction

The **HART Offline**  mode gives more offline capabilities. All devices available in the HART library can be used. Typical operations are:

1. Connect to an energized HART device to see its configuration and save to file.
2. Full configuration is available for all commands (universal/common and device specific).
3. Change setup files.
4. Work offline to make setup files.
5. Upload setup files to HART devices.
6. Export setup files (to USB flash drive). Not possible for a DPI620G-IS.
7. Import setup files on the PC for to read offline.

9.5.2 Device Polling

A connected HART device can have a special Poll Address. To set up a new HART Offline connection:

1. Tap on **CONNECT TO DEVICE** and select **SCAN FOR DEVICES**.

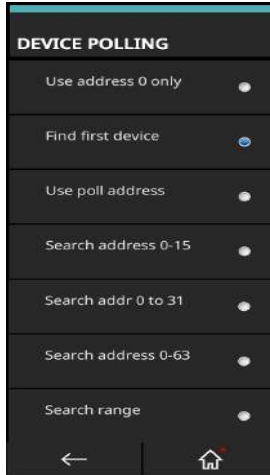



Figure 9-6: HART Menu

2. Tap on the necessary scheme type for polling from the following options and then tap the **Previous screen**  icon:

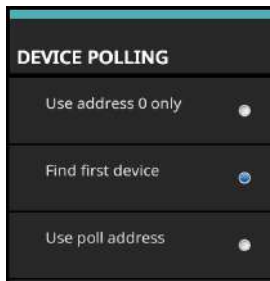



Figure 9-7: HART Device Polling Options

- Select **"Use address 0 only"** to search for any device found on address 0 only.
- Select **"Find First Device"** to search from 0 to 63 and use the first device found.
- Select **"Use poll address"** to search a specific poll address number. Choose a number from 0 to 63 to find any device found on that specific address only.
- Select **"Search address 0-15"** to search poll address 0 to 15 and use the first device found.
- Select **"Search address 0-31"** to search poll address 0 to 31 and use the first device found.
- Select **"Search address 0-63"** to search poll address 0 to 63 and use the first device found.
- Select **"Search range"** to use a specified address range to select from a range of devices at poll addresses within that range.

3. After you select the poll scheme type, tap the **Search**  icon to start the search.
4. The **SCAN FOR DEVICES** list shows all found devices.

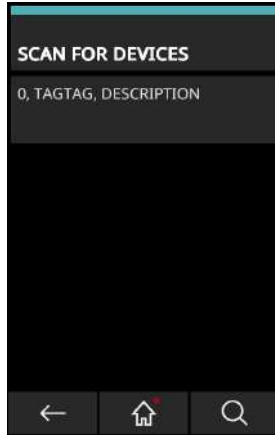

Figure 9-8: HART® Device List

5. Select the device: tap on the menu row with the sensor name and tap on the **Yes** button in the screen message that has the “Connect to device?” message. The system will then complete the connection process.
6. After a successful connection, the HART offline function will be shown.

9.5.3 Connected Device Configuration

1. Tap the **HART® Offline** icon .

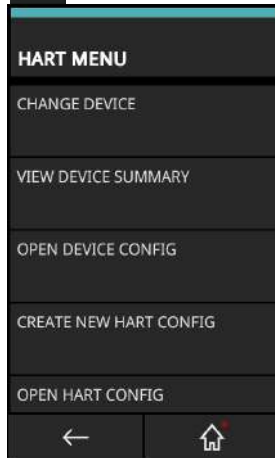

Figure 9-9: HART® Offline Menu

2. Select **OPEN DEVICE CONFIG**.
3. The display will show information about the connected device.
4. Change the device information if necessary.

9.5.4 Change Device

To change the connected device to another device, select the **CHANGE DEVICE** option from the HART menu.

Tap **SELECT DEVICE** from the list, to choose from devices already detected by the DPI620G or tap **SCAN FOR DEVICES** to start a new scan.

9.5.5 View Device Summary

Select **VIEW DEVICE SUMMARY** from the HART menu to view details of the connected device.

The information shown can only be seen in this mode and data cannot be changed.

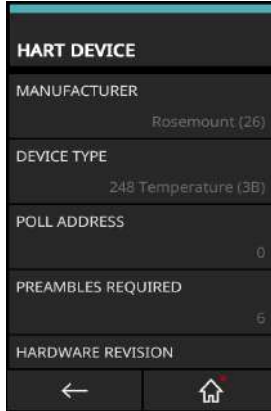

Figure 9-10: HART® Offline – Device Summary

9.5.6 Open Device Configuration

Select the **OPEN DEVICE CONFIG** from the HART menu to see and change the device setup. The device **PV (URV and LRV)** parameters can be seen and changed.

Note: The options and structure given in the configuration menu, changes from one HART device to another.



Figure 9-11: HART® Offline – Device Configuration

Chapter 9. HART® Operations

In this example, there is one more **DEVICE SETUP** menu that you can select, to access more advanced configurations.

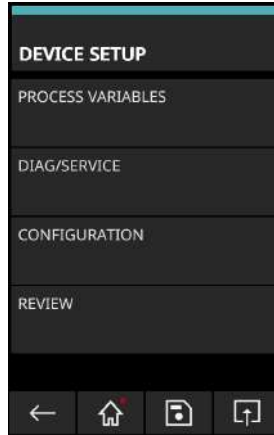

Figure 9-12: HART® Offline – DEVICE SETUP Example

The available **DEVICE SETUP** menu options will change from device to device but will usually have the:

- **PROCESS VARIABLES** -
- **DIAG/SERVICE** – usually has calibration related parameters.
- **CONFIGURATION** – has only a few basic device data such as device TAG, Units, Damping.

- **REVIEW** – has a full list of the setup parameters available for the device.

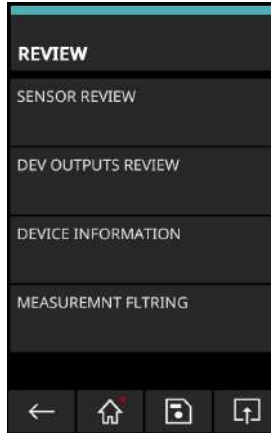



Figure 9-13: HART® Offline – Review

Each option gives related parameters or settings related to the device.

To go back to the previous menu screen, tap the  icon.

Note: An unchanged setup parameter will be shown as green colored text (except in the **REVIEW** menu). Once changes occur, the text color changes to yellow. The changed parameter text remains yellow until the changes have been sent or written to the device.

To save any changes, tap the **Save**  icon and select from the following options:

- **SAVE/SAVE AS** – saves the current setup file which includes the new changes made as a new setup file. When you select this option, you can give the new setup a new filename or overwrite an existing filename. You can access this file from the Open HART configuration menu or through a PC in the “HartOfflineData” folder in the DPI620G file system.
- **SEND TO DEVICE** – writes the current setup file (and includes new changes made to the HART device.)

When you select this option, choose from the following upload mode options:

- **All Parameters** - Save/write all setup parameters.

- **Modified Parameters Only** - Save/write only changed setup parameters.



Figure 9-14: HART Offline – Send to Device Save Options

- **SAVE AND SEND TO DEVICE** – saves the current setup as a file in the internal storage of the DPI620G and also writes the current setup (this includes any new changes to the HART device.)
- **SAVE TO USB** – saves the selected setup as a file on a USB flash memory device. Make sure a compatible USB flash memory device connects to the DPI620G before this option is selected.
- **SAVE AND COPY TO USB** – saves the selected setup as a file, both in the internal storage of the DPI620G and also on a USB flash memory device. Make sure a compatible USB flash memory device connects to the DPI620G before the selection of this option.

9.5.7 Create a New HART Configuration

To make a new device setup, select **CREATE NEW HART CONFIG** from the HART Offline menu. The screen will show the **HART DEVICE** menu.



Figure 9-15: HART Offline – Create New HART® Configuration

Select the following sections (in order):

1. **MANUFACTURER** – name of Manufacturer.
2. **DEVICE TYPE** – model or device name, based on manufacturer selected.
3. **DEVICE REVISION** – based on device manufacturer and type selected.
4. **DD REVISION** – based on device manufacturer, type and revision.

Figure 9-16: HART Offline – Example New HART Configuration

When all sections are complete, tap the  icon.

Enter the CONFIG file name if different from the default device name. Select the  icon to confirm / save and go back to the **Offline Configuration** menu of the device.

Figure 9-17: HART Offline – Configuration File Name Entry

9.5.8 Open a HART® Offline Configuration

After the offline setup (either connected or disconnected) is made, use this option from the **HART Offline** menu to read the setup file.

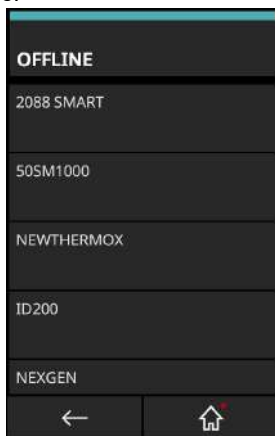

Figure 9-18: HART Offline – Saved Configuration Files Selection

Select the necessary setup to load from the saved files.

9.5.9 File Management

Use the **FILE MANAGEMENT** menu to copy or delete HART setup files.

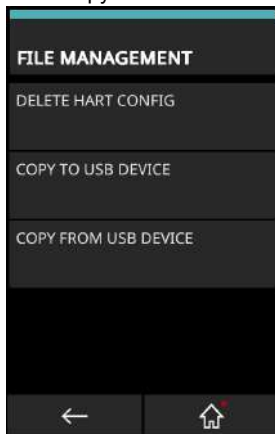



Figure 9-19: HART Offline – Configuration File Management

Note: When you copy to or from a USB flash memory device, make sure that you have fully connected the USB flash memory device before you select the menu option.

9.6 HART® Online

HART devices can be connected to the DPI620G in the HART ONLINE mode. This lets detailed setups be done. To set up a device connection ONLINE, select the **HART ONLINE**  icon.

This starts a Device Poll search, based on the Poll Scheme you select in the HART menu (**OFFLINE** mode). Tap on the device data after the device has been found, and tap **OK** to complete the connection and start the SDC Application.

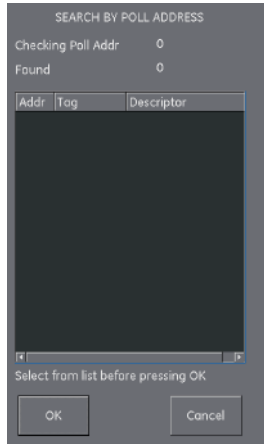

Figure 9-20: HART® Poll Address Search

9.6.1 HART® SDC Application

When you have connected the device in the HART ONLINE mode, the HART SDC application automatically starts. See Section 9.6.

The DPI620G shows the **HART SDC** application screen in light or dark mode.

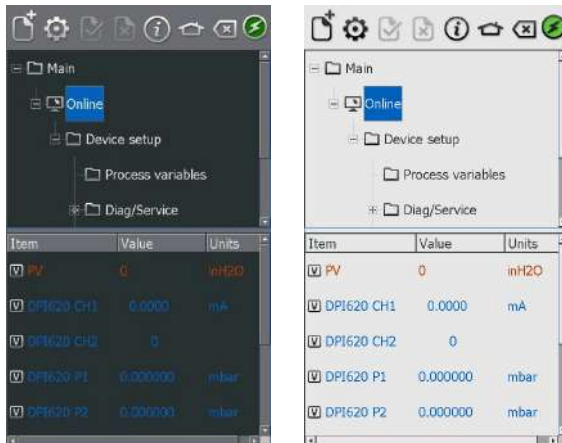

Figure 9-21: HART® SDC Application Main Screen

Chapter 9. HART® Operations

9.6.1.1 HART® Toolbar



Figure 9-22: HART® Toolbar

When the **HART® SDC** application starts, the screen shows a toolbar. The icons are gray when they are not in use.

The icons and their functions are in the table below:

Icon	Name	Description
	OPEN NEW CONNECTION	The HART® SDC application must close and the restart from Dashboard.
	PREFERENCES	Selection of Search Options (Poll Address / Short and Long Tags). See Figure 9-23.
	COMMIT	Commit updated values back to the device. Refer to Section 9.6.3.
	ABORT	Stop update of parameters: revert to previous values. Refer to Section 9.6.3.
	STATUS	Field Device Status and HART operations summary. See Figure 9-24.
	HOME	Go back to Dashboard. Minimizes HART application.
	CLOSE	Close down connection and goes to Calibrator screen.
	DEVICE COMMUNICATIONS ON	Indicator that shows active communication.
	DEVICE COMMUNICATIONS STARTING	Indicator shows communication is starting.
	DEVICE COMMUNICATIONS FAILED	Indicator shows data transfer has not occurred.

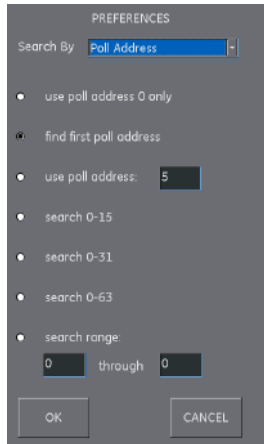

Figure 9-23: HART Poll Preferences

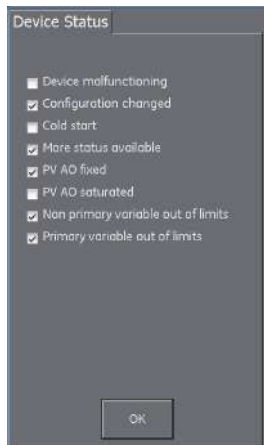

Figure 9-24: HART Device Status

9.6.2 HART® SDC Data Display

The display data is color coded:

Color	Description
Red	HART transmitter data (cannot be changed).
Blue	DPI620G channel data (cannot be changed).
Black/White	Data that can be changed.

Chapter 9. HART® Operations

Common acronyms used are as follows:

Acronym	Description
PV	Primary Variable
AO	Analogue Output
URV	Upper Range Value
LRV	Lower Range Value
USL	Upper Sensing Limit
LSL	Lower Sensing Limit

The device data screen also shows the real-time readings of the instrument channels. Calibration procedures use these settings.

9.6.3 How to change Device Data Values

A value that is in white/black with a [V] or [E] icon, can be changed. To change variables:

1. Select the variable
2. If a selection window opens, select the variable (or select **Edit** icon).



Figure 9-25: HART Write Variable Selection

3. Enter a new value.
4. Select the **Set** icon.
5. Select **OK** icon to go to the primary application screen.
6. The new value is highlighted in yellow.

Note: To go back to the original value, tap the **Abort**  icon in the menu bar.

7. Select **Commit**  icon in the menu bar to write and use the new value. The yellow highlight will be shown after new data the device puts in storage.

9.7 Executing HART Methods

Not all HART devices have the same methods available.

The function, purpose and execution of each method can be different: this depends on the device in use. Methods can be:

- Self-test
- Loop test
- Sensor trim
- D/A trim.

To execute the above listed methods:

1. Select the required folder in the SDC data structure.

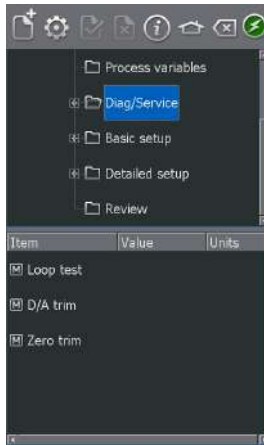



Figure 9-26: HART® Method – SDC Data Structure

2. Select the method name from the available list of method options. A screen opens with information about the selected method.

Four icons appear on the screen:

Icon	Description
HELP	Shows a description of the method.
ABORT	Exits from the procedure.
OK	Accepts inputs and proceeds to the next step.
SWITCH APP	Returns to DPI620G screen (to change channel function settings without interruption of the method procedure). To go to the Method procedure, tap the
HART ONLINE 	icon.

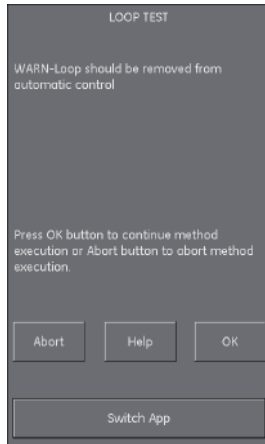

Figure 9-27: HART® Method Screen Example

Note: Some methods can make the HART device output a specified current. The screen will show a warning message before the device enters this mode.

3. Some methods need values to be entered. To do this use the alphanumeric keypads when necessary.
4. A drop-down menu is available for method selection options.
5. Some methods require input from the DPI620G instrument channels. A drop-down menu shows these channels:
 - CH1
 - CH2
 - P1
 - P2
 - IDOS
6. On completion, the procedure will go to the HART application. If necessary, use the **Abort** icon to cancel the procedure.

9.7.1 HART Method Example – Self-Test

1. To make sure that the transmitter correctly functions, go to the Test device folder.
2. Select the Test device folder.
3. Select **OK**.

The self-test occurs.

9.7.2 HART® Method Example – Analog Trim

The DPI620G can do an analog trim on the 4 to 20 mA loop without a connection to an external reference meter.

1. Go to the calibration folder.

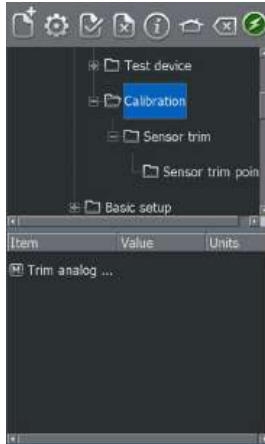

Figure 9-28: HART® Method – Analog Trim

2. Select the “Trim analog” method.
3. Follow the on-screen instructions. If **CH2** is set to **Measure Current (24V)**, you can use this to supply the reference meter value.
4. Read the **CH2** value and use the keypad to enter this in the meter value text box.



Figure 9-29: Enter Calibration Point

5. Select **SET**.
6. Repeat steps 3, 4 and 5 with “20mA” selected. This calibrates the transmitter’s output current.

9.8 HART® SDC Application Preferences

Tap the **Preferences** icon  to set up the HART device search method.

The application lets a search be done by the use of:

- Poll Address - when each transmitter has a unique address.
- Short tag - if the transmitter supports 8-character tags.
- Long tag - if the transmitter supports 32-character tags.

Transmitters with a non-zero poll address are in multi-drop mode and default to a fixed loop current of 4mA.

By default, the DPI620G polls address 0 (zero) only. Change the Poll Address by the selection of the appropriate search radio icon or enter the tag name in the search field.

9.9 HART® Device Connection Failure

Fault	Possible Cause	Action
Failed to find device.	Power Supply	Make sure device is turned on. Examine applicable fuses. Make sure the supply voltage is within limits.
	Device under Test	Make sure the device is HART® compatible. Connect multiple devices one at a time.
	Circuit	Examine circuit connections. Examine circuit Continuity. Make sure polarity of supply to the transmitter is correct. Make sure the HART® resistor is in the correct place in the loop. Make sure the HART® resistor has the correct value. Make sure the loop current is in the range 3.5mA to 24mA.
	DPI620G	Make sure the DPI620G connects to the correct points in the loop. No external HART® resistor present, examine the internal resistor setting. External HART® resistor present, make sure the DPI620G resistor setting is OFF. Make sure that the CH2 function is set to “None” if the DPI620G is used as a secondary master (in parallel with an external supply).
	Preferences	Select the “search 0-63” option to scan all possible Poll Addresses to get the Poll Address and Tag details of the connected device.

9.10 HART® Configurations

9.10.1 HART® – Uploading the Configuration

You can tap the **Upload**  icon in the **Commands** menu, to upload the setup to the connected device.

9.10.2 HART® – Working with Saved Configurations

Select a Saved Configuration from the primary offline menu to let you do the following operations:

- Open HART Config - This lets you change a previously saved HART setup file.
- Upload Config to Device -This lets you upload a previously saved HART setup file to a connected device.

9.10.3 Copy HART® Configuration to USB

This lets a previously saved HART setup file be saved to a USB flash drive. The USB flash drive must be inserted into the DPI620G before you select this option.

After you copy the HART setup file to the USB flash drive, you can modify, copy or clone it on a PC.

9.10.4 Delete HART® Configuration

Erases the HART setup file from the DPI620G.

9.10.5 Delete All HART Setup Files

From the primary offline menu, tap the **“Select All”**  icon and then the **Delete**  icon: all saved setup files are then erased.

9.10.6 Import Setup Files from USB Flash Drive



INFORMATION Any files on the DPI620G with the same name as files on the USB flash drive will be overwritten.

Insert a USB flash drive that holds saved configuration files. From the primary offline menu, tap the **New Configuration** icon.

9.11 How to connect a DPI620G-IS to HART® compatible devices

This section gives the methods to connect a DPI620G-IS Intrinsically Safe (IS) instrument, which operates as a HART communicator with a HART transmitter.

9.11.1 Active HART Current Loop

This example shows a calibrator that connects directly to a network. There must be a 250Ω resistor in series with the loop power supply and the HART device. When the connection is in this mode, the external series HART resistor cannot be replaced with the internal HART resistor.

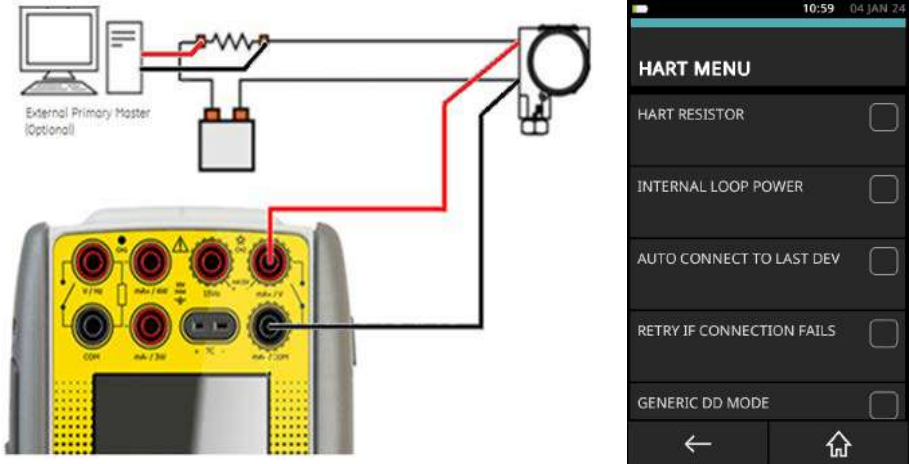

Figure 9-30: Connection to an Active Current Loop

- Use the instructions in Section 9.2 on page 109 and Section 9.3 on page 109 to prepare the instrument to use the HART function.
- Tap on the **CUSTOM TASK** to select this mode.
- Set the communicator channel **CH2** to **None**.
- Set the communicator channel to **HART**.
- Make sure that **HART RESISTOR** is not selected (Checkbox must be empty).
- Make sure that **INTERNAL LOOP POWER** is not selected (Checkbox must be empty).

The DPI620-IS can operate as a Primary Master, when no other Primary Master attaches to the network. The DPI620-IS can operate as a Secondary Master when it connects to a HART loop that is in operation.

9.11.3 Transmitter - Internal Loop Power Supply with Current Measurement

In this example the DPI620G-IS supplies the loop power and makes available a 250Ω HART resistor.

- Use the instructions in Section 9.2 on page 109 and Section 9.3 on page 109 to prepare the instrument to use the HART function.
- Tap on the **CUSTOM TASK** to select this mode.
- Set the communicator channel **CH2** to **None**.
- Set the communicator channel to **HART**.
- To make available HART functions, set the internal HART resistor to ON: use an on-screen checkbox to do this. This lets HART data be transmitted when connection is made in this mode with the DPI620G-IS.

This instrument measures the current in the current loop. If an external HART resistor is available, use the connection method given in “Active HART Current Loop” on page 130..

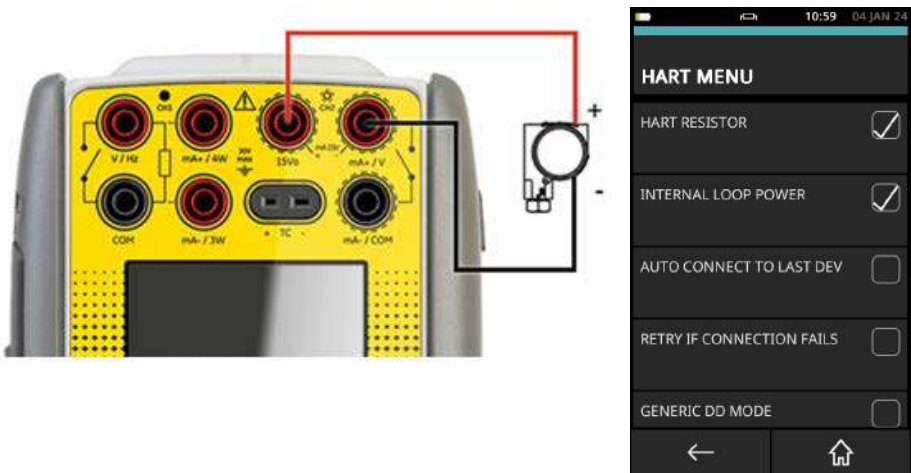

Figure 9-32: Connection with Internal Loop Supply

The internal loop supply, which is intrinsically safe, has an internal impedance of 100Ω at high loop currents. It is possible that the transmitter minimum voltage necessary, will not be supplied when the 250Ω HART resistor is also included in the loop circuit. The next page gives instructions for how to avoid this situation.

A diagrammatic representation of the loop is shown by Figure 9-33

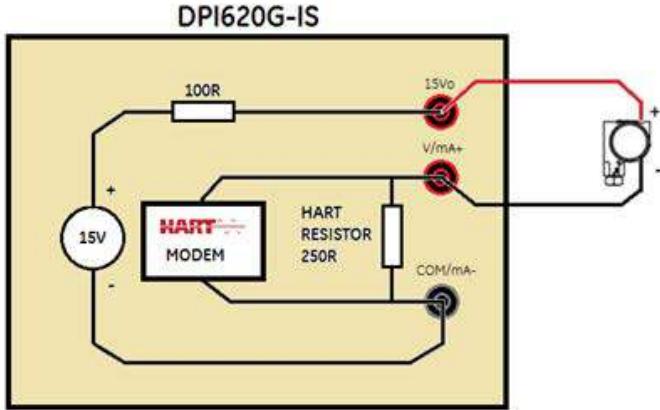

Figure 9-33: Internal Loop Supply - Current Measure

For example: At a loop current of 15mA, the voltage drop will be $15\text{mA} \times (100\Omega + 250\Omega) = 5.25\text{V}$. In this example the voltage at the transmitter will be 9.75V.

The graph below shows the transmitter voltage with (red line) and without (blue line) the HART resistor in the current loop. There must be no significant additional impedance in the Current Loop for this graph to be accurate.

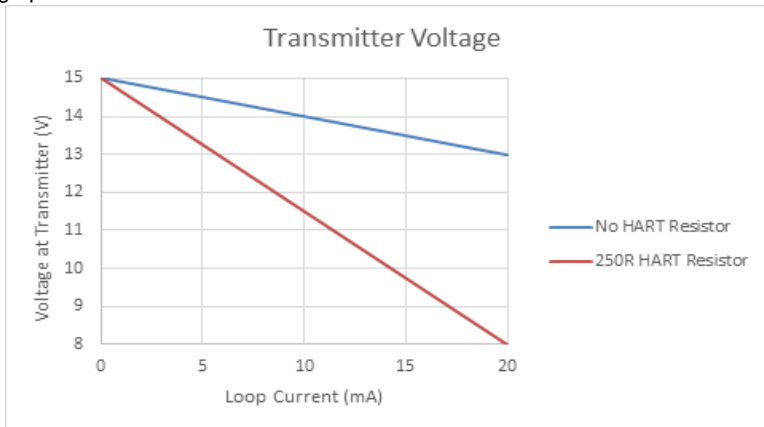

Figure 9-34: Transmitter Voltage

Bad conditions can occur in which the transmitter has to operate. For example, when the loop current can decrease the voltage at the transmitter to below its minimum operating voltage. When this occurs, use an external power supply (Refer to Section 2) or use a parallel HART connection with the Internal Loop Supply (Refer to Section 4).

Note: For the use of an external power supply, the voltage drop made by the loop impedance (Power supply impedance + HART resistor) in relation to the transmitter operating voltage must still be included.

9.11.4 Transmitter - Internal Loop Power Supply with Parallel HART® Connection

In this example, the internal power supply is the source of the loop power. The loop impedance necessary for the HART function is given by the output impedance of the internal power supply (Refer to Note 1 at the bottom of this page).

The loop current from the Channel 2 terminals cannot be measured when connected in this mode.

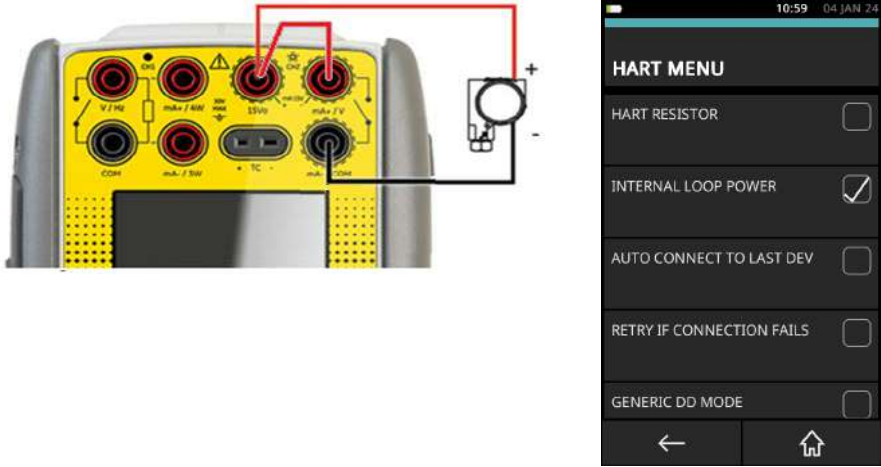

Figure 9-35: Connection with Internal Loop Supply - Parallel HART Connection

- Use the instructions in Section 9.2 on page 109 and Section 9.3 on page 109 to prepare the instrument to use the HART function.
- Tap on the **CUSTOM TASK** to select this mode.
- Set the communicator channel **CH2** to **None**.
- Set the communicator channel to **HART**. Make sure the **HART RESISTOR** is off (the checkbox must be empty).
- Set **INTERNAL LOOP POWER** to ON (checkbox must have a tick mark).

Figure 9-36 shows diagrammatic representation of the loop:

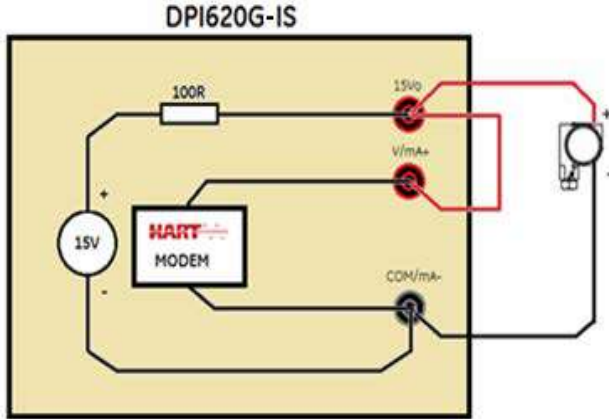

Figure 9-36: Internal Loop Supply - Current Measure

In this mode, the voltage drop, because of loop impedance, is minimized, and the voltage at the transmitter will be as shown by the "No HART resistor" (blue line) plot in Figure 9-34 on page 133.

Note 1: The DPI620G-IS obeys the HART Physical Layer Test Specification when used with a 230Ω HART resistor. This is when the DPI620G-IS connects directly to a transmitter, that also obeys the HART Physical Layer Test Specification. The use of test leads of <3m length, the 100Ω output impedance of the internal loop supply, will give a ratio of 1.45 between the minimum transmit voltage levels and the minimum receive levels for the DPI620G-IS and the HART® transmitter.

9.11.5 The Measurement of Loop Current with a Parallel HART Connection

When connected with a parallel HART® connection it is not possible to measure current on Channel 2. To measure the loop current and/or do a current loop trim, it is necessary to use the Channel 1 current measure function.

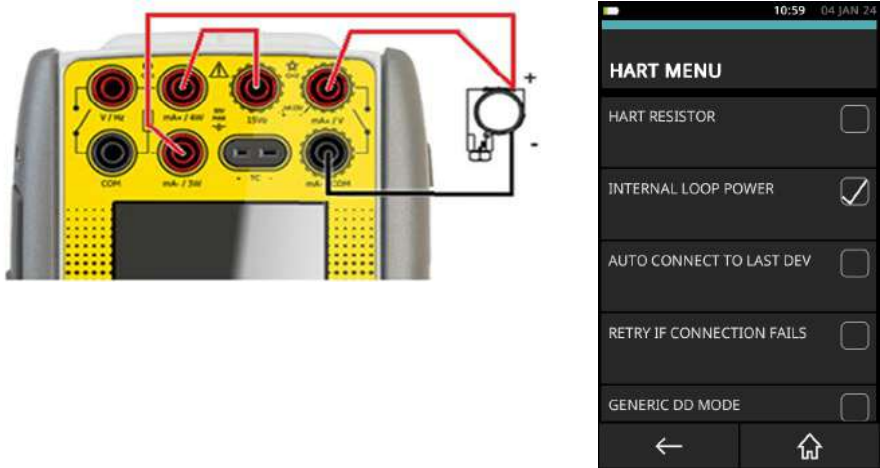

Figure 9-37: Connection with Internal Loop Supply - Parallel HART Connection

- Use the instructions in Section 9.2 on page 109 and Section 9.3 on page 109 to prepare the instrument to use the HART function.
- Tap on the **CUSTOM TASK** to select this mode.
- Set the **CH1** channel to **Current Measure** and the **CH2** channel to **None**.
- Set the communicator channel to **HART**. Make sure the **HART RESISTOR** is off (the checkbox must be empty).
- Set **INTERNAL LOOP POWER** to ON: tick the checkbox.

Figure 9-38 shows a diagrammatic representation of the loop:

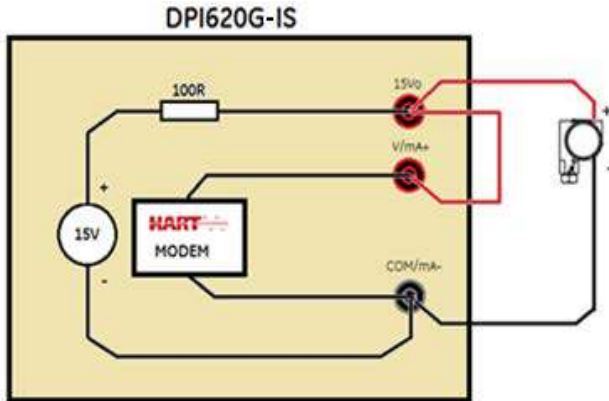

Figure 9-38: Internal Loop Supply - Parallel Connection - CH1 Current Measurement

9.11.6 Transmitter - Test Connection

To use the Test connection on a HART® transmitter: use **CH1** to measure current and **CH2** to communicate with the HART device. Follow these instructions:

- Use the instructions in Section 9.2 on page 109 and Section 9.3 on page 109 to prepare the instrument to use the HART function.
- Tap on the **CUSTOM TASK** to select this mode.
- Set the **CH1** channel to **Current Measure** and the **CH2** channel to **None**.
- Make sure that **HART RESISTOR** is not selected (Checkbox must be empty).
- Make sure that **INTERNAL LOOP POWER** is not selected (Checkbox must be empty).

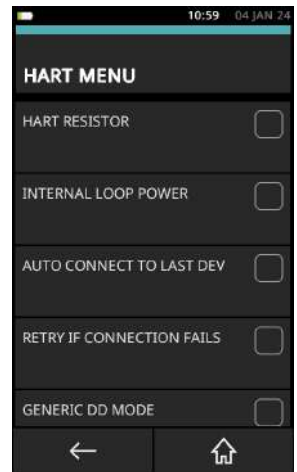
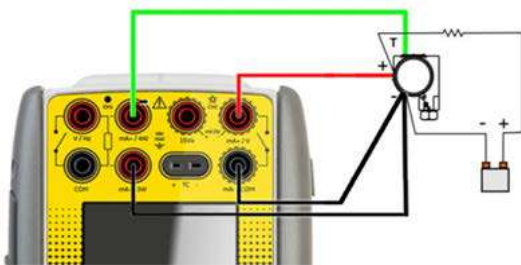

Figure 9-39: HART IS Test Connection

Chapter 9. HART® Operations

The test connection in the transmitter can be +ve or -ve. Figure 9-39 shows a connection for a +ve Test terminal. For a -ve Test terminal, the Test terminal must connect to the **CH1** mA-terminal and the **CH1** mA+ connect to the transmitter +ve terminal.

9.11.7 Positioner - Internal Loop Power Supply with Current Source

In this example, the internal power supply is the source of the loop power. The output impedance of the internal power supply and the current sourcing circuit, supply the loop impedance for the HART function. Use this connection method for all devices that are powered (and controlled) by a current source..

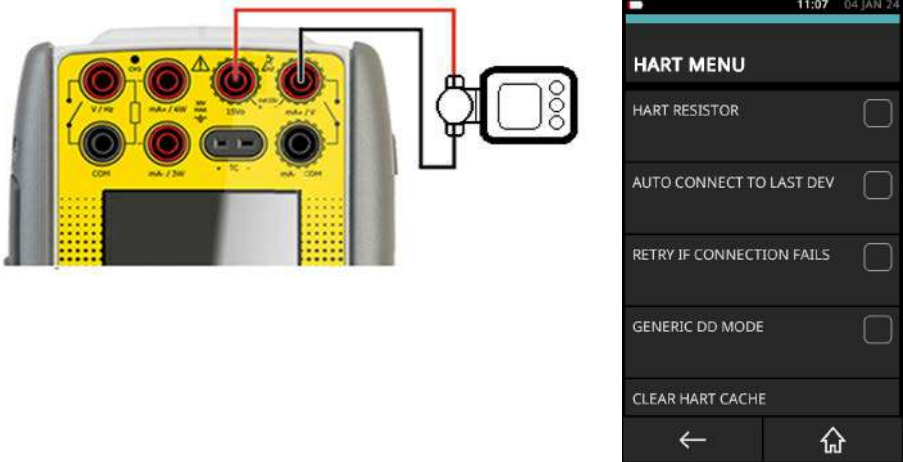
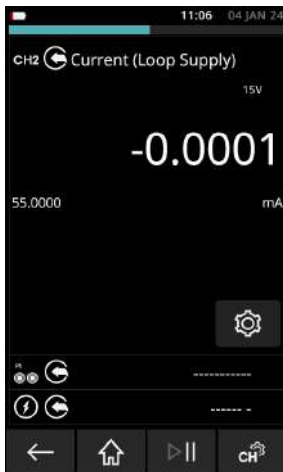

Figure 9-40: Positioner Connection with Internal Loop Supply



- Use the instructions in Section 9.2 on page 109 and Section 9.3 on page 109 to prepare the instrument to use the HART function.

- Tap on the **CUSTOM TASK** to select this mode.

- Set the **CH2** function to Current Source (Loop Supply). Set the current to the minimum input current (typically 4mA).

- Make sure that **HART RESISTOR** is not selected (Checkbox must be empty).

- Make sure that **INTERNAL LOOP POWER** is not selected (Checkbox must be empty)

For these devices, it is important that the DP620G-IS is in current source mode and operates as a controlled current source. If the DP620G-IS is in current measure mode, the device under test will take the maximum current given by the power supply: HART data transmission is not possible. To control the positioner, the source current can be set between 4 mA and 20mA.

9.11.8 Positioner - External Loop Supply with Current Source

In this example, an external power supply supplies the loop power. The loop impedance necessary for the HART function is given by the current sourcing circuit and optional internal HART resistor. This connection method should be used for all devices that are powered (and controlled) by a current source.

In this example, an external power supply supplies the loop power. The loop impedance for the HART function is supplied by the current sourcing circuit and an optional internal HART resistor. Use this connection method for all devices that are powered (and controlled) by a current source.

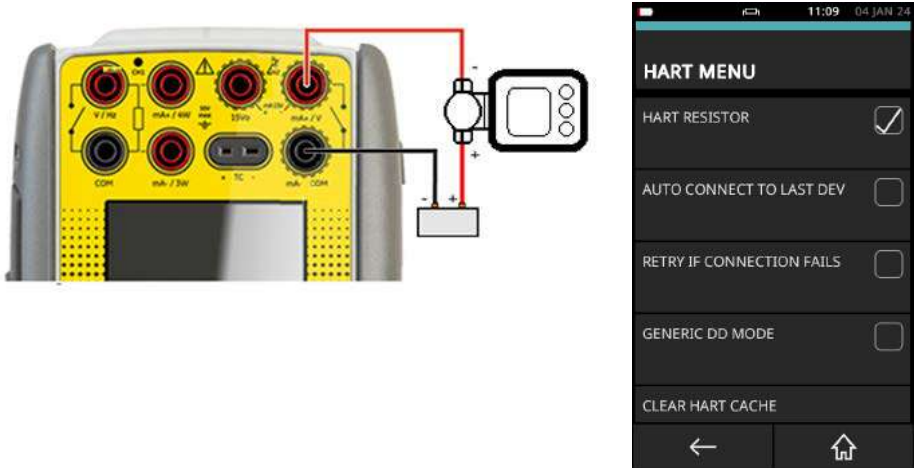

Figure 9-41: Positioner Connection with External Loop Supply

- Use the instructions in Section 9.2 on page 109 and Section 9.3 on page 109 to prepare the instrument to use the HART function.
- Tap on the **CUSTOM TASK** to select this mode.
- Set the **CH1** channel to **Current Measure**.
- Set the **CH2** function to Current Source (Loop Supply). Set current to the minimum input current (typically 4mA).
- Make sure that **HART RESISTOR** is ON (Checkbox must have a tick mark in it).
- Make sure that **INTERNAL LOOP POWER** is not selected (Checkbox must be empty).

For these devices, it is important that the DPI620G-IS is in current source mode and operates as a controlled current source. If DPI620G-IS is in current measure, the device under test will take the maximum current from the power supply: HART communications cannot be used. To control the positioner, set the source current between 4 mA and 20mA.





10. FOUNDATION™ Fieldbus

10.1 Introduction

FOUNDATION™ Fieldbus (FF) is a device application for the configuration of FF enabled Field devices. The integrated H1 modem does the online connection. FF can configure and use devices that directly connect to a H1 Field segment.

10.2 Start up

10.2.1 Start up for the DPI620G

Tap the **FIELDBUS**  icon on the Dashboard to start the FOUNDATION Fieldbus. An alternative method is to select the FOUNDATION Fieldbus by the use of the **CALIBRATOR** function: Select the **Fieldbus** option on the **COMMUNICATOR**  channel in the **CUSTOM TASK SETTINGS**.

To make a FOUNDATION Fieldbus online connection:

1. Connect the DPI620G instrument to a H1 FOUNDATION Fieldbus device.

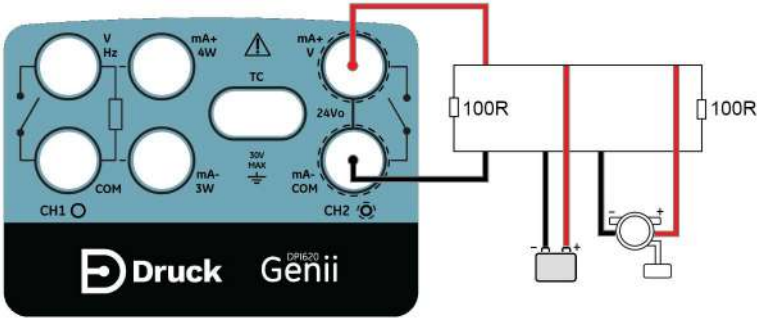

Figure 10-1: Example Connection Diagram FOUNDATION™ Fieldbus

2. Tap on the FOUNDATION Fieldbus channel to make it change to its expanded form. Refer to Section 3.1.1.

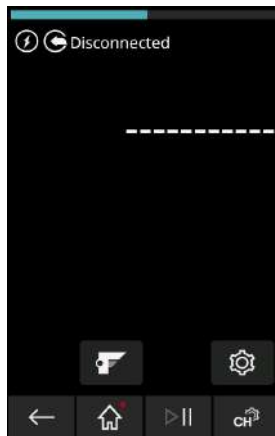



Figure 10-2: Calibrator Fieldbus Channel

3. Tap the  icon.
4. The main FOUNDATION Fieldbus application will start.

Note: To update the **CH1**, **CH2**, **P1** or **P2** tasks is only possible when the FOUNDATION Fieldbus application does not operate. Tap the Home  icon and then select **Exit** to close the FOUNDATION Field bus application. Refer to Section 10.3.

Note: Make sure the DPI620G USB setting is in the **Storage Device** mode. See Section 2.4.4 on page 28.

Note: **CH2** is set in the Volts measure mode. To try to select a function on **CH2** will not succeed: the display will show an information message and the selected function will not be available.

10.2.2 Start up for the DPI620G-IS

The DPI620G-IS can work with devices that use the FOUNDATION Fieldbus H1 implementation. This is done by the use of an integrated H1 modem.

Note: The H1 modem hardware is only included in DPI620G-IS-FF or DPI620G-IS-FFPB.

This section gives instructions for how to connect a FOUNDATION Fieldbus device to the DPI620G-IS.

10.2.2.1 IS FOUNDATION Fieldbus Configurations

Before the electrical connections between the FOUNDATION Fieldbus device and the DPI620G IS are set, the correct setup must be done.

A FOUNDATION Fieldbus network at its simplest consists of a field device, two terminators and a power supply. The terminators and power supply are available within the DPI620G-IS.

This lets the connection of the DPI620G-IS to:

- Connect with an existing network where the power supply and termination are available.
- Connect with Stand-alone FOUNDATION Fieldbus devices.
- Connect networks in between.

Note: The DPI620G IS internal power supply is current limited to approximately 30mA.

10.2.2.2 Start up - DPI620G-IS

To start the FOUNDATION Fieldbus tap the **Fieldbus**  icon on the dashboard:

Tasks can be selected for **CH1**, **P1** and **P2** (refer to Section 2.2 on page 16).

CH2 is automatically set into the Volts measurement mode. To try to select a function on **CH2** will make the display show an information message and the selected function will not be set.



Figure 10-3: IS CH2 Function Not Set message

Selection of the FOUNDATION™ Fieldbus can also be done from the **CALIBRATOR** function:

Select the **COMMUNICATOR** channel from the **TASK SETTINGS** Function then select **FIELDBUS**.

Note: **Volts measure** or **None** are the only valid modes for channel 2 when Fieldbus is operational.

10.2.2.3 Start up - FOUNDATION Fieldbus Connections

To start the FOUNDATION Fieldbus application and connect to a network:

1. Connect DPI620G-IS to a H1 FOUNDATION™ Fieldbus network..

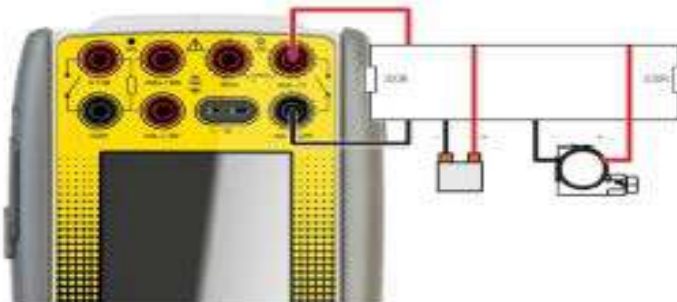

Figure 10-4: Example IS Connection Diagram FOUNDATION™ Fieldbus - External Network



Figure 10-5: Example IS Connection Diagram FOUNDATION™ Fieldbus - Internal Network

2. Select the FOUNDATION™ Fieldbus channel so that it is in its expanded view (refer to Section 3.3 on page 37).

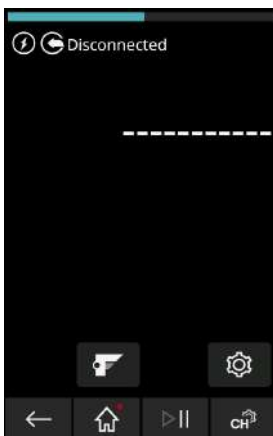

Figure 10-6: Calibrator Fieldbus Channel

3. Select the SETTINGS  icon to set the network.



Figure 10-7: Calibrator Fieldbus Terminator Settings

4. Tick the related boxes to make available the Terminators and Internal Power Supply. Resistor icons at the top of the screen show the Terminator mode.

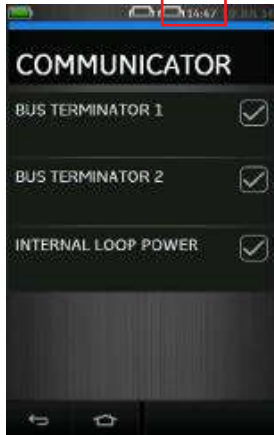



Figure 10-8: Calibrator Fieldbus Terminator icons

Note: Bus Terminator 1 and Bus Terminator 2 are identical, thus only one is necessary.

5. Select the Back  icon to return to the FOUNDATION Fieldbus channel view.

10.2.2.4 FOUNDATION Fieldbus Application – Connection to a Network

6. Tap the Fieldbus  icon on the dashboard to start the FOUNDATION Fieldbus application.



Figure 10-9: IS FOUNDATION Fieldbus Application screen

If the application does not open and the screen shows an error message, check that the instrument is a DPI620G-IS-FF or DPI620G-IS-FFPB.

Note: To update the **CH1**, **P1**, and **P2** tasks is only possible when the FOUNDATION™ Fieldbus application is not in operation – to close select: **HOME** >> **Exit** (refer to Section 10.3 on page 146).

10.3 FOUNDATION™ Fieldbus Toolbar

When the FOUNDATION Fieldbus application starts, the display shows the toolbar. The icons are gray when they are not active or available for use.



Figure 10-10: FOUNDATION Fieldbus Toolbar

The icon functions are:

Icon	Name	Description
	OPEN CONNECTION	Only available when awaiting an open connection. (When navigating devices Open Connection is replaced by the Close icon).
	CLOSE	Only available in navigation tree (refer to Section 10.9) and Functional Group view (refer to Section 10.10). This icon closes down the connection and returns to Device Focus view (refer to Section 10.8).
	SETTINGS	Application configuration settings and DD library details (refer to Section 10.15).
	COMMIT	Commit updated values back to the device (refer to Section 10.10.3).
	ABORT	Abort Update of parameters, reverts to previous values (refer to Section 10.10.3).
	STATUS	Provides device profile of currently connected device (refer to Section 10.5).
	FUNCTION FINDER	Search FF variables and device functions.
	HOME	Returns to Main Application. Allows user to either minimize or exit. If FOUNDATION™ Fieldbus readings are to be referenced in Main Application, then minimize should be selected.
	DEVICE COMMUNICATIONS ON	Indicator showing active communication.
	DEVICE COMMUNICATIONS OFF	Indicator showing no active communication.

10.4 Scanning for Devices (DPI620G & DPI620 IS)

The following steps describe how to look (scan) for FOUNDATION Fieldbus devices through a FOUNDATION Fieldbus H1 connection:

1. Connect the DPI620G (or DPI620 IS) to the H1 bus. Refer to Section 10.2.
2. Tap the **OPEN CONNECTION**  icon on the Toolbar to show the device scan screen.

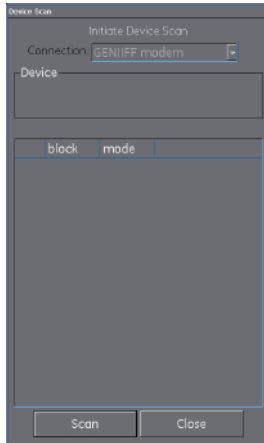

Figure 10-11: Device Scan Screen

3. Tap the **SCAN** icon.

The scanning progress dialog view opens. Any devices found in the selected range will appear in the bus tree window list. All scanned devices are shown as a bold icon with an associated tag. Previous scan results are indicated in gray.

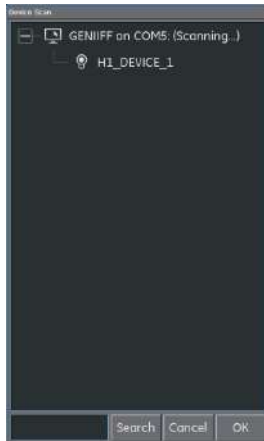

Figure 10-12: Device Scan View

Note: If necessary, you can select the **CANCEL** icon to stop the scan immediately. If canceled the current scan results are kept.

A search term can be entered into the **SEARCH** dialog to look for a specific device in the found scan list.

4. Select a device in the search results and select **OK** to start the connection to the **'Device Focus view'**.
5. To scan again, tap and hold on **"Genii Modem COM5"** and select **"Re-scan"** from the drop-down list.

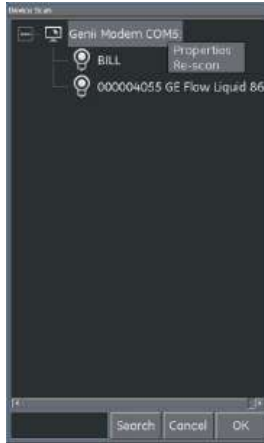

Figure 10-13: Re-scan

10.5 Context Sensitive Menu

Context sensitive menus are available for each device in the **Device Scan** menu: tap and hold down the PD tag (device name).



Figure 10-14: Context Sensitive Device menu

This gives access to the following functions:

1. Tag / Address Change - which includes:
 - a. Set Tag.
 - b. Set Address.

- c. Clear Tag.
 - d. Clear Address.
2. Boot Operational Function (BOF) class change - which includes:
 - a. Set Basic.
 - b. Set Link Master.
 - c. Set Bridge.
 3. Restart device.
 4. Properties - displays device attributes.



Figure 10-15: Device Profile

5. The device Block List can also be found here (default functionality is to use “**Device Focus View**” - refer to Section 10.8).
6. Remove - removes the device.

10.6 DPI620G-IS Device State

A FOUNDATION™ Fieldbus device can be in one of three modes:

Uninitialized – No tag, No permanent address

Initialized – Tag, No permanent address

Operational – Tag and permanent address

A device must be given a tag and a permanent address before the Device Focus View can be used.

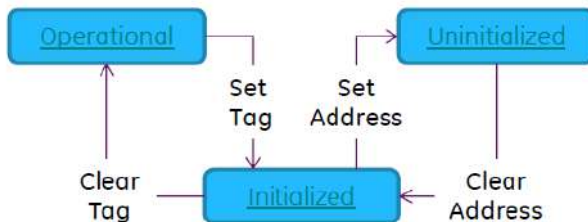

Figure 10-16: Device Modes

10.7 Troubleshooting

If no device is found when the scan check is done:

1. The field wiring - make sure that the electrical segment connections are correct, as defined by the specific user manual supplied with the field device and segment coupler / power supply.
2. Make sure that an unstable voltage supply from the segment power supply and / or electrical interference, does not cause interference with the operation of the loop power supply.

Some bridging devices / LAS implementations use an optimization where some address ranges are not scanned. This can result in an individual device not being found.

After the address is set, it may take some time for the device and the Link Active Scheduler (LAS) to synchronize information: this includes address, identity, and protocol timing information.

10.8 Device Focus View

This view shows the specific information of the device:

- PD tag.
- Device Id.
- Block List with Target / Actual Mode.

On entering '**Device Focus view**', the software loads the Blocks of the target field device and makes them available for parameterization.



Figure 10-17: Device Focus View

Select the **Scan** icon to show device scan view again. Refer to Section 10-11.

Select the desired block with a single key tap to open the Navigation Tree for the block. Refer to Section 10.9.

10.9 The Navigation Menu Tree

This is the overview of the fully loaded block of the device (this is not the entire field device, only one part of it). This overview shows all the menus available, as controlled by the configured access level. Many field devices have additional menus that become visible when an access right is enabled, or other parameters set. The navigation tree shows nested menus with a '+' to the left of the description. A tap of this symbol opens up the view to the lower level. This view can be

closed by a tap on the view ‘-’ setting. The method lets complex device menu structures be moved through quickly and clearly.

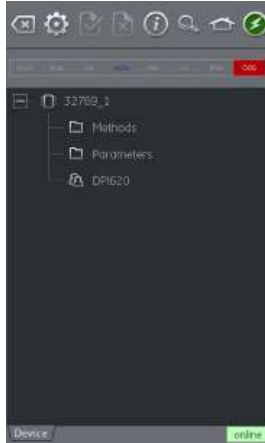

Figure 10-18: Navigation Tree

10.9.1 Block Header bar

The block header bar identifies the target and operation mode of the block.



Figure 10-19: Block Header Bar

The highlighted text shows the mode of the device block.

The highlight is in green if the target mode is equal to the operation mode of the device block. The highlight is red when the target mode does not equal the operation mode of the device block.

Blue text shows the target mode of the device block.

Black text identifies options that are available; the screen shows unavailable options in gray.

The target mode can be changed with a quick tap on the block header.

Figure 10-19 shows an example where the target mode is Auto but the operation mode is Out of Service (OOS).

10.10 Functional Group View

The functional groups show all the variables or settings in that menu group together with the real-time value.

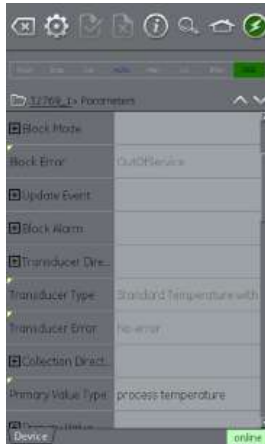

Figure 10-20: Function Group View

The left side has the “**Variable Description Area**” and gives access to the context-based adjustment functions.

The right side, with a light background, has the “**Variable Editing Area**” and gives access to value adjustment.

A gray value relates to a read-only value: for example, a variable that the device produces.

Variables with black text can be changed when the applicable access conditions are correct: for example, an access code or PIN that can be necessary for use in a different Functional Group.

The Navigation Tree bar shows the hierarchy of menus and groups above the current Function Group View.



Figure 10-21: Navigation Tree Bar

To move back out of the function group is possible: tap the linked references in the tree bar itself (e.g. 32769_1 in Section 10-21).

The up and down ∇/\blacktriangle navigation arrows move the selected function group to that of the one above or below the current selection in the menu tree.

Communication activity (online/offline) is shown by the communication progress bar in the bottom right of the screen.

10.10.1 How to show Parameter Help

- The yellow triangle in the corner of the Variable Description area shows that help is available for that parameter.
- The context drop-down menu can be opened: tap and keep down the required variable descriptor.

- Select the “Display Help” option to show the Help attributes.

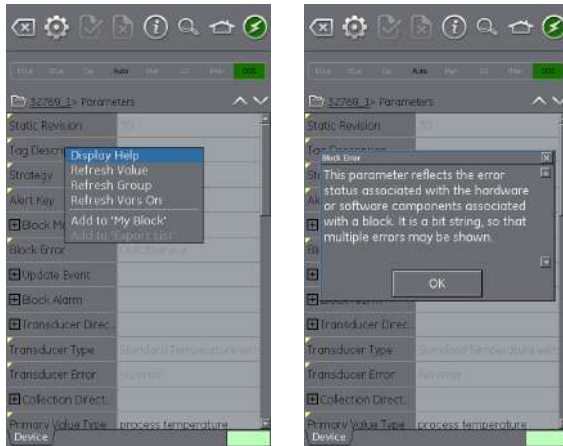

Figure 10-22: Parameter Help

10.10.2 How to refresh Data

When a refresh is in progress the variable description becomes gray and the right area of the Variable Editing area shows the Pending (clock) icon.



When the read request is fulfilled the variable description changes from gray to black again and the Pending (clock) icon disappears.



Use the drop-down context menu to do a data refresh. The following options are available:

Refresh Option	Description
Refresh Value	Updates selected value only.
Refresh Group	Updates all values in the function group.
Refresh Vars On	Automatically refreshes values.
Refresh Vars Off	Manual refresh required to update values.

10.10.3 Editing Values



Values that can be changed are shown in black in the “variable editing area” of the function group view. Refer to Figure 10-20. Select the required parameter to open for editing.

Chapter 10. FOUNDATION™ Fieldbus

When the edit is complete, the variable description is then highlighted in bold and the **Commit** and **Cancel** icons in the toolbar become available for use.



Figure 10-23: Edit Value

Icon	Description
	Commits all Update
	Aborts all Updates

Individual updates can be reverted by selecting “**Revert Value**” from the context menu. (Accessed by a tap and hold action on the variable description).

Note: This can only occur if the update has not yet been committed.

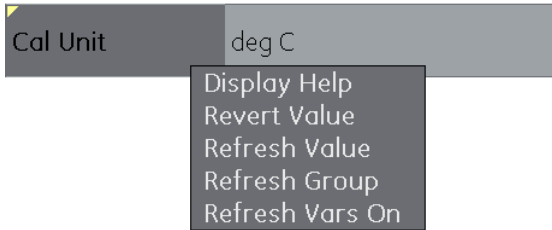

Figure 10-24: Revert Value

If an invalid value is entered the variable becomes red and the error (cross) icon appears.



Figure 10-25: Invalid Value

10.10.4 Methods

These are viewed as an icon or selection menu. To tap the “**Execute**” icon starts the execution of the related functionality. The user then follows any defined prompts to process the method.

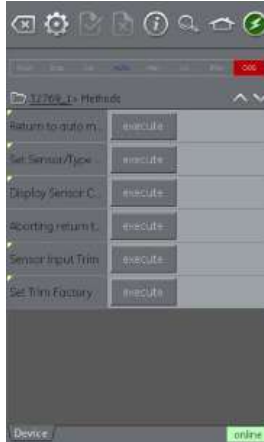

Figure 10-26: Methods

10.11 Fieldbus Function Finder

Function Finder lets searches be done for FF variables and device functions in the online device, and in complex devices with multiple menus. This lets the user find a device without the use of a manual: this makes the online experience task an easier experience, even with an unfamiliar device.

The system requires the input of the name of the variable concerned (or part thereof) and the results show all variables that match the search. Navigation to the variable is just a single click in the search results. To start a search, proceed as follows in the online or offline device view:

1. Select the search icon from the FOUNDATION Fieldbus Toolbar.
2. In the “**Name**” field, enter the text to search and tap **OK**.
3. Tap the **Search** icon to start the search.

Chapter 10. FOUNDATION™ Fieldbus

- From the list of results, select the necessary parameter. Note that the variable name and the function group it relates to, is shown.

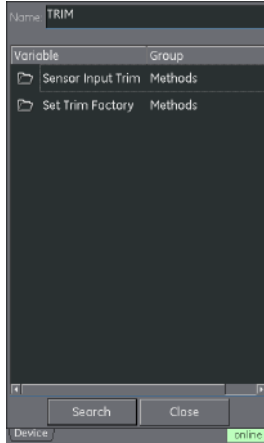

Figure 10-27: Found 'TRIM' Methods

- Function Finder then shows the related Function Group in the device view, with all searched variables highlighted in yellow. Refer to Figure 10-28.



Figure 10-28: Function Finder

10.12 How to Export Data to the PrimaryDPI620G Application

The FOUNDATION Fieldbus application lets selected parameters be shown in the **Communications** channel window on the Calibrator screen.

The **Export List** section defines the selected parameters, which is on the tree directory of the connected device.

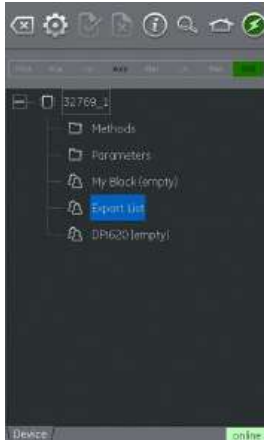

Figure 10-29: Export List

Parameters are added to the Export List by the use of the context menu in the Variable Description area. Refer to Figure 10-30.

Note: Only Parameters that give a value can be added to the Export List.

Note: A Maximum of six parameters can be added to the Export List.

Select the **Export List** menu to see the items on list.

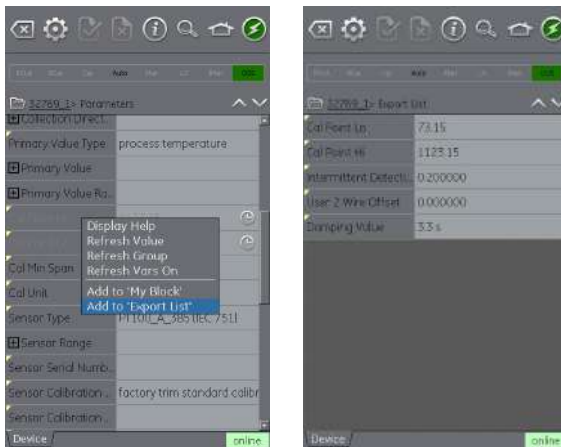



Figure 10-30: Adding Items to Export List

10.13 How to see Exported Variables in the Channel Window

Minimize the FOUNDATION Fieldbus application (tap the **Home**  icon) to go back to the main application.

Expand the FOUNDATION Fieldbus window, select the **Settings**  icon and then tap **PRIMARY VALUE**.

The display will show the **Export List** of selected parameters.

The FOUNDATION Fieldbus channel window will show a selected parameter.

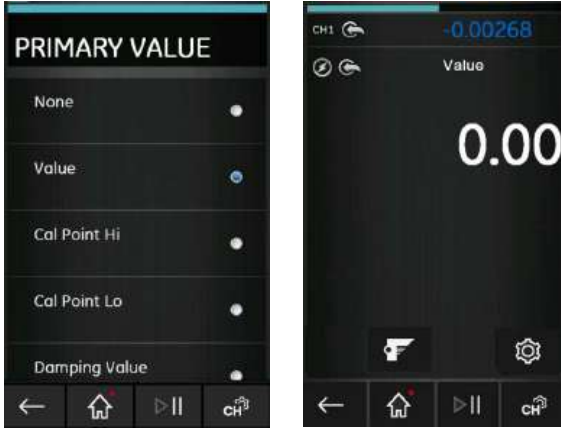

Figure 10-31: Displaying Primary Value

10.14 Fieldbus Application – My Block

My Block lets the user create menus of commonly used parameters for easy recall.

Additional menus can be created under 'My Block'. Use the context menu accessed with the tap and hold gesture.



Figure 10-32: Setting up My Block

Use the context menu in the **Variable Description** area to add parameters to **'My Block'** (or the created menu). Refer to Figure 10-33.

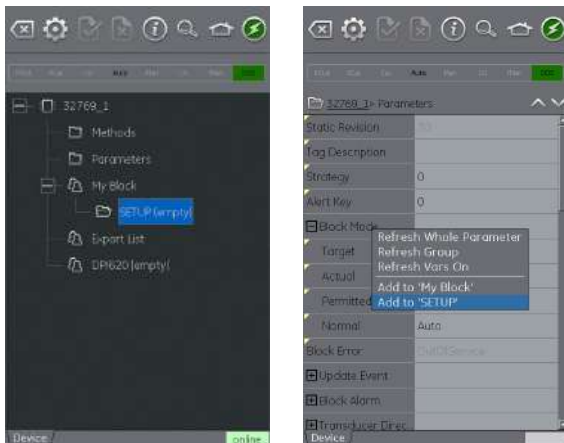

Figure 10-33: Adding Parameters to My Block

10.15 Application Settings

Select the **Settings**  icon to access application settings from the FOUNDATION Fieldbus toolbar.

10.15.1 Device Library

The library tab shows the Device Descriptions (DDs) that are on the DPI620G. This lets the user look for a device, to find if that there is support for it.

To request support for a non-registered DD please contact your local Baker Hughes Service center. Refer to Section 1.18.4.

10.15.2 Options

Option	Description
Poll header every	Sets the refresh rate for the device parameters shown in the header.
Poll all dynamic every	Sets the refresh rate for FF dynamic variables in the function group view (note this setting only becomes valid if the function group option Refresh Vars On is active). Refer to Section 10.10.
Enable Device Library Monitor	If checked, enables the automatic check of the Open Field Communications (OFC) DD library on application start up for new Device Descriptions. Note this configuration option requires a network path to the Internet. After installation, the default setting is 'checked'.
Confirm Device Commits	If checked, brings up a confirmation dialog before every write is committed to the field device. After installation, the default setting is 'checked'.
Enable My Device Functions	Enables the 'My Device' and Export to DPI620G functions. After installation the default setting is 'checked'.
Enable Value Range Checking	If checked, makes sure that all variable edits are within the limits specified by the device. After installation, the default setting is 'checked'.
Enable Function Blocks	If checked, function blocks are enabled. After installation, the default setting is 'unchecked'.
Enable Transducer Blocks	If checked, transducer blocks are enabled. After installation, the default setting is 'checked'.

10.15.3 Advanced

These settings are for advanced users only and it is recommended to keep default values.

11. Profibus® PA

11.1 Introduction

The DPI620G can communicate with devices that use Profibus® PA Fieldbus implementation. This is done by the use of an integrated modem.

Note: The modem hardware is only included in DPI620G-PB or DPI620G-FFPB.

This chapter gives information of how to connect the Profibus® PA device to the DPI620G and DPI620G-IS.

11.2 Profibus® Configurations

The correct configuration must be done before the setup of the electrical connections between the Profibus® device and the DPI620G/DPI620 IS.

The DPI620G-IS can work with devices that use the PROFIBUS PA Fieldbus implementation. This is done by the use of an integrated modem.

Note: The IS modem hardware is only included in DPI620G-IS-PB or DPI620G-IS-FFPB.

A Profibus® network at its simplest consists of a field device, two terminators and a power supply. This lets the connection of the DPI620G or DPI620G-IS to:

- Connect with an existing network where the power supply and termination are available.
- Connect with Stand-alone Profibus® PA devices.
- Connect networks in between.

11.3 Start-up

To start Profibus®, select the **Profibus®** application icon from the Dashboard screen.

CH2 automatically stays in the **Volts measure** mode. To try to select a function on **CH2** will be a failure: the display will show an information message and the selected function will not be available.



Figure 11-1: CH2 Function Not Set when Profibus® is Enabled

Profibus® can also be selected from the **Calibrator Task Menu** by selecting the Profibus® option in the Field Communications channel.

Note: **Volts measure** or **None** are the only valid modes for **CH2** when PROFIBUS® is operational.

11.4 Profibus® Connections

To start the PROFIBUS application and connect to a network:

1. Connect the DPI620G to a PROFIBUS PA network.

Start up for the DPI620G

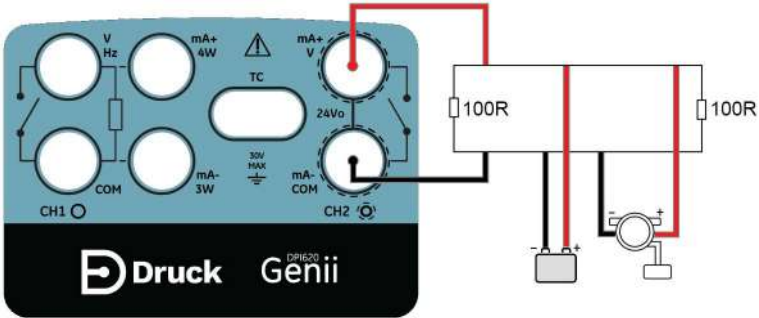

Figure 11-2: Example Connection Diagram Profibus

Start up for the DPI620G-IS

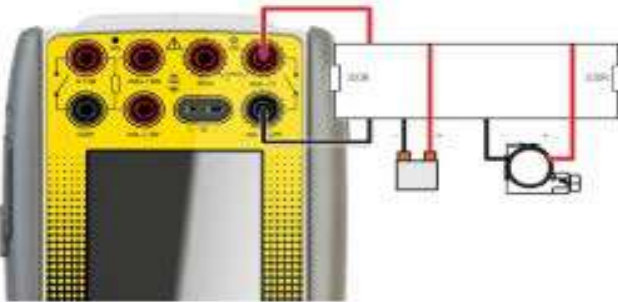

Figure 11-3: Example IS Connection Diagram Profibus ROFIBUS – External Network



Figure 11-4: Example IS Connection Diagram Profibus ROFIBUS – Internal Network

2. Tap on the PROFIBUS® channel to make it change to its expanded form.

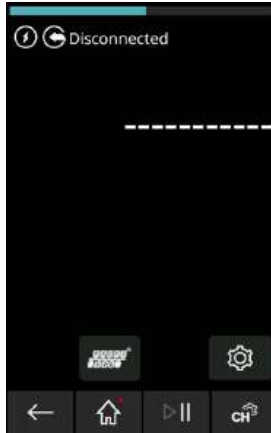



Figure 11-5: Calibrator Profibus® Channel

3. Tap the **Settings**  icon to configure the network.
4. Tap the **Back**  icon to go back to the PROFIBUS® channel view.

11.5 Profibus® Application – Connecting to a Network

Tap the **Profibus®**  icon on the expanded Profibus® channel to start the application.



Figure 11-6: Profibus® Application

If the application does not open and an error message appears, make sure that the unit is a DPI620G-PB or DPI620G-FFPB.

Note: Updating **CH1**, **P1**, and **P2** tasks is only possible when the PROFIBUS® application is not in operation.

Note: Make sure the DPI620G USB setting is in the **Storage Device** mode. See Section 2.4.4 on page 28.

11.6 Profibus® Toolbar

When the Profibus® application starts, the display shows the toolbar. The icons are gray when they are not active or not available for use.



Figure 11-7: Profibus® Toolbar

The icons functions are:

Icon	Name	Description
	OPEN CONNECTION	Only available when awaiting an open connection. (When navigating devices Open Connection is replaced by the Close icon).
	CLOSE	Only available in navigation tree (refer to Section 11.10.2). This icon closes down the connection and returns to Device Focus view (refer to Section 11.10.1).
	SETTINGS	Application configuration settings and DD library details (refer to Section 11.13).
	COMMIT	Commit updated values back to the device (refer to Section 11.10.7).
	ABORT	Abort Update of parameters, reverts to previous values (refer to Section 11.10.7).
	STATUS	Provides device profile of currently connected device (refer to Section 11.10.1).
	FUNCTION FINDER	Search FF variables and device functions.
	HOME	Returns to Main Application. Allows user to either minimize or exit. If Profibus® readings are to be referenced in Main Application, then minimize should be selected.
	DEVICE COMMUNICATIONS ON	Indicator showing active communication.
	DEVICE COMMUNICATIONS OFF	Indicator showing no active communication.

11.7 Scanning for Devices

The following steps describe how to scan for PROFIBUS® PA devices through a PROFIBUS® PA connection:

1. Connect the DPI620G to network. Refer to Section 11.4.

2. Tap the **OPEN CONNECTION**  icon on the toolbar to enter device scan screen.



Figure 11-8: Profibus® Device Scan Screen

3. Tap the **'Scan'** icon.

The scanning progress dialog view opens. The tree window shows a list of devices found. All scanned devices are shown as a bold icon with a related descriptor and device type (separated by a '/'). If the descriptor has not been set, only the device type will be shown.

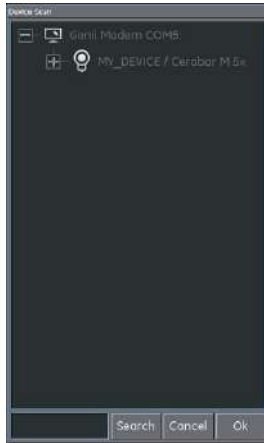

Figure 11-9: Profibus® Device Scan View

Note: If necessary, you can select the **CANCEL** icon to stop the scan immediately. If canceled, the current scan results are kept.

A search term can be entered into the **Search** bar to look for a specific device in the discovered scan list.

4. Select a device in the search results and then select **OK** to start the connection to the **Device Focus** view. Refer to Section 11.10.1.
5. Scan again: use the context sensitive menu, modem option. Refer to Section 11.8.

11.8 Context Sensitive Menu

Context sensitive menus are available for the modem and each device in the bus tree window list. To access the context sensitive menu tap on the relevant field text until the display shows the related screen.

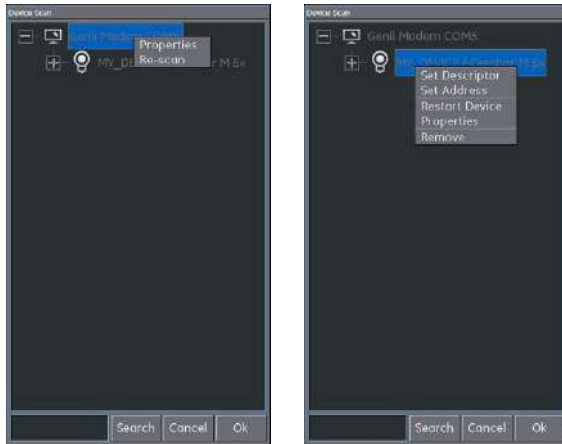

Figure 11-10: Profibus® Context Sensitive Menu

This screen gives access to the following functions:

1. Modem - this gives access to the following functions:
 - a. Properties (Displays modem profile).
 - b. Rescan.
2. Descriptor/Address Change - which includes:
 - a. Set Descriptor.
 - b. Set Address.
3. Boot Operational Function (BOF) class change - which includes:
 - a. Restart Device.
 - b. Properties (Displays device profile).
 - c. Remove.

11.9 Troubleshooting Connection Problems

If no device is found when scan check is done:

1. Field wiring - make sure that the electrical segment connections are correct, as defined by the specific user manual supplied with the field device and segment coupler / power supply.
2. Make sure that an unstable voltage supply from the segment power supply and / or electrical interference, does not cause interference with the operation of the loop power supply.
3. The required termination is in the network.
4. The internal power supply, if required, is energized (switched on).

Some bridging devices / LAS implementations use an optimization where some address ranges are not scanned. This can result in an individual device not being found.

After the address is set, it may take some time for the device and the Link Active Scheduler (LAS) to synchronize information: this includes address, identity, and protocol timing information.

11.10 Profibus® Application – Communication

11.10.1 Device Focus View

This view has the specific information of the device, for example:

- Device Descriptor.
- Device Type.
- Block List with Target / Actual Mode.

When the **Device Focus** view starts, the software loads the Blocks of the target field device, which makes them available for parameterization.

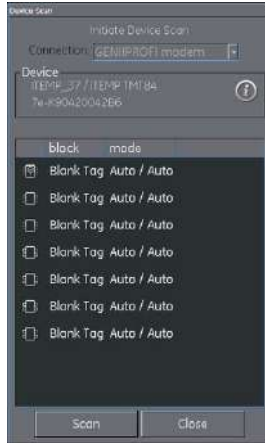





Figure 11-11: Profibus® Device Focus View

There are three types of blocks:

Icon	Block Name	Description
	Resource	Devices only have one resource block. Specifies the general characteristics of the device. For example, device type, manufacturer ID and serial number.
	Transducer	Reads the physical sensor information. Functions as a coupler between the function blocks and the physical sensors.
	Function	Gives the control by talking to the transducer blocks to set the Inputs and Outputs. Devices can have a defined set of functions they can perform, e.g. Analog Input (AI).

Note: The **Settings** menu controls if the function blocks can be seen or not in the **Device Focus** view. (Refer to Section 11.13.2).

Select the information icon to show the device profile.



Figure 11-12: Profibus® Device Profile

Tap the **Scan** icon to show the **Device Scan** view again. Refer to Figure 11-8. Selection of the desired block with one key tap opens the Navigation Tree for that block. Refer to Section 11.10.2.

11.10.2 Block Navigation Tree

The screen will show the navigation tree after the selection of a block.

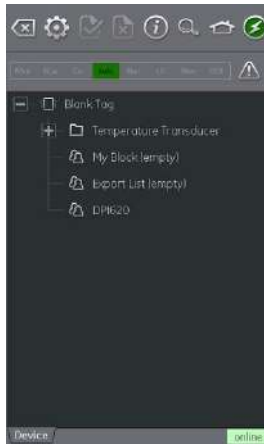

Figure 11-13: Profibus® Navigation Tree

Any folder with a '+' symbol to the left can be expanded by selecting the folder name and similarly any with a '-' symbol, can be contracted.

The navigation tree will show a number of folders that have:

- Device variables
- My Block
- Export List
- DPI620.

Chapter 11. Profibus® PA

My Block - is a "favourites" location to which device variables can be added. Refer to Section 11.11.

Export List - is a location for the device variables that will be in the Communication channel window of the main DPI620G application. Refer to Section 11.12.

DPI620G - shows a list of all the variables that are used by the channels of the main DPI620G application.



Figure 11-14: Profibus® Navigation Tree – DPI620G

11.10.3 Block Header Bar

The block header bar indicates the target and actual mode of the block.



Figure 11-15: Profibus® Block Header Bar

The highlighted text indicates the operation mode of the device block. The highlight is shown in green if the target mode is equal to the operation mode of the device block. If the target mode does not equal the operation mode of the device block, the highlight will be red.

Available options are indicated by black text; unavailable options are shown in gray.

The target mode can be changed with a quick touch on the block header or by running a block method.

The Block Header bar will have a warning symbol if there is an problem with the device communications.



Figure 11-16: Profibus® Block Header Warning

Click on the warning symbols to show more information.

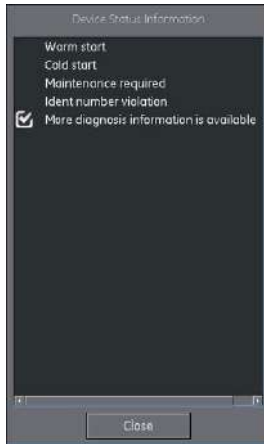

Figure 11-17: Profibus® Block Header Warning Information

11.10.4 Folder Variables

Click on a folder that cannot be expanded, to see the folder variables.

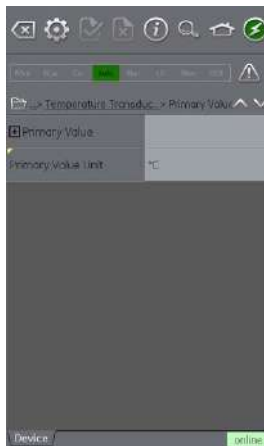

Figure 11-18: Profibus® Folder Parameters

The left side has the “**Variable Description Area**” and gives access to the context-based adjustment functions. The right side, with a light background, has the “**Variable Editing Area**” and gives access to value adjustment.

Some folders hold executable methods.

The navigation tree bar shows where the view is in the device hierarchy.



Figure 11-19: Navigation Tree Bar

Navigation back out of the folder is possible by the linked references in the tree bar itself (e.g., Temperature Transducer > Primary value in).

Chapter 11. Profibus® PA

The up and down navigation arrows move the selected set of folder parameters to that of the one above or below the current selection in the menu tree.

Communication activity is signified by the communication progress bar in the bottom right of the screen.

11.10.5 Displayed Parameter Help

The yellow triangle in the corner of the **Variable Description** area indicates that help is available for that parameter.

Open the **Context** menu with a tap and hold move. Select **“Display Help”** to show the help attributes.

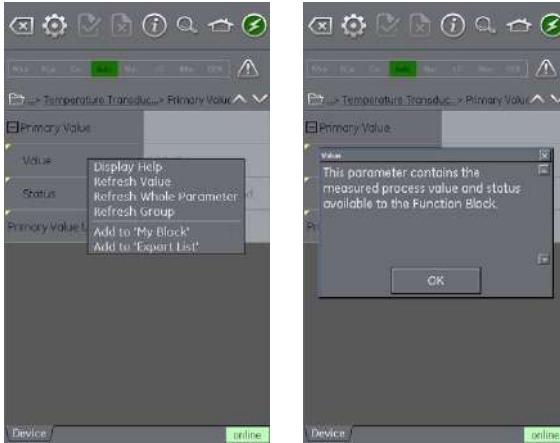

Figure 11-20: Profibus® Parameter Help

11.10.6 How to refresh Data

When a refresh operation is in progress, the variable description goes gray and in the right-hand side of the **Variable Editing** area the pending icon appears.



Figure 11-21: Profibus® Variable refresh

When the read request is fulfilled, the variable description goes from gray to black again and the pending icon disappears.



Figure 11-22: Profibus® Refreshed Variable

A data refresh can be selected from the drop-down context menu with the following options:

Refresh Option	Description
Refresh Value	Updates selected value only.
Refresh Group	Updates all values in the function group.
Refresh Vars On	Automatically refreshes values.
Refresh Vars Off	Manual refresh required to update values.

11.10.7 Editing Variables

Some variables can be changed. Select the variable to open.

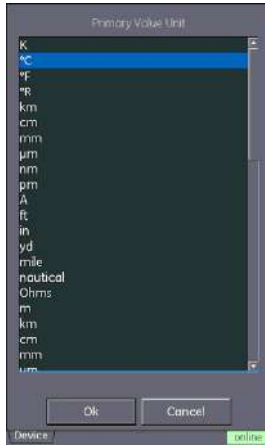

Figure 11-23: Profibus® Primary Variable Unit

When editing is completed, the variable description is highlighted in bold and the **Commit** and **Cancel** icons in the toolbar become available for use.



Figure 11-24: Profibus® Edited Parameter

Icon	Description
	Commits all Update
	Aborts all Updates

If necessary, select **Revert Value** from the context menu to go back to the update used before the new update. (Accessed by a touch and hold on the variable description).

Note: This can only occur if the update has not yet been committed.



Figure 11-25: Profibus® Invalid Variable Value

11.11 Profibus® Application – My Block

My Block allows the user to create a list of regularly used variables for future use.

Chapter 11. Profibus® PA

Additional folders can be made under **My Block** by the use of the context menu (accessed with touch and hold.)

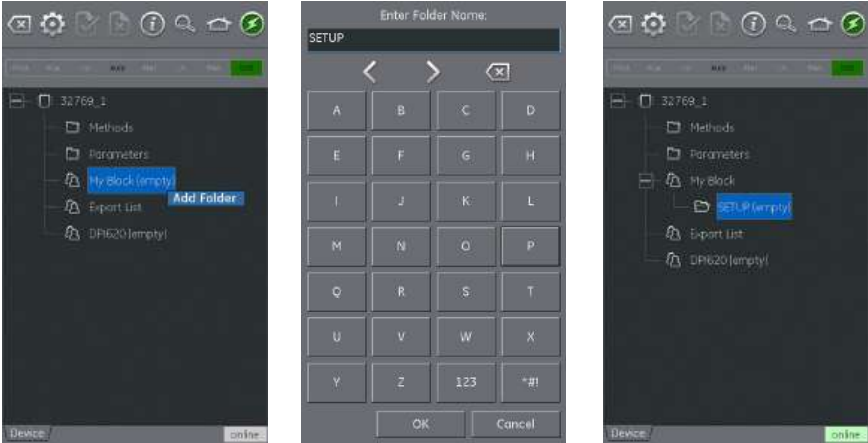

Figure 11-26: Profibus® 'My Block'

11.12 Profibus® Application – Exporting Variables

The PROFIBUS® application lets the **Communications** channel window show selected variables. Use the **Export List** menu to specify the selected variables. Refer to Section 11.10.2. Use the context menu in the **Variable Description** area and select **Add to 'Export List'** to add parameters to the **Export List**.

Note: A maximum of six variables (and only variables that return a value) can be added to the Export List.

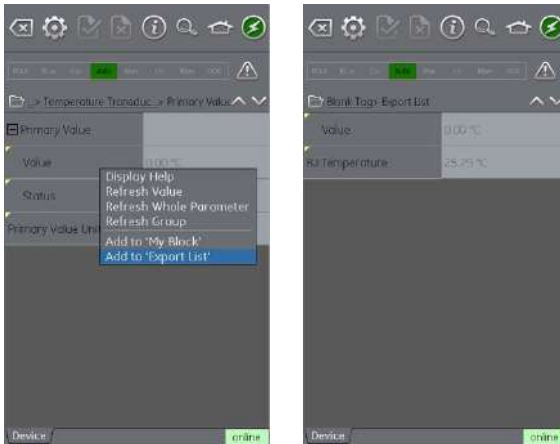

Figure 11-27: Adding Items to Export List

11.12.1 Viewing Exported Variables in Channel Window

To go back to the main application: minimize the Profibus® application (tap the **Home**  icon).

Expand the Profibus® window, select the **Settings**  icon and then tap **PRIMARY VALUE**.

The screen will show the **Export List** of selected parameters.

Profibus® channel window will show selected parameters.

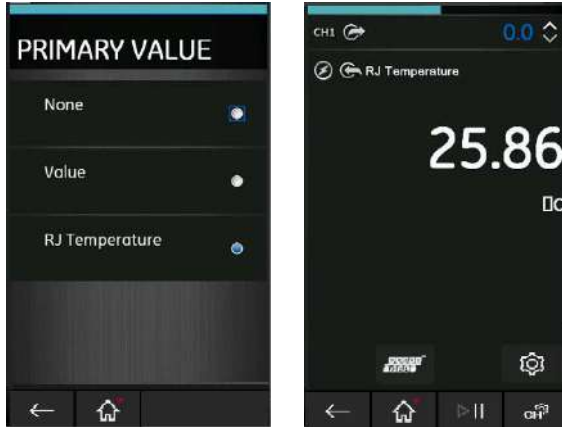

Figure 11-28: Displaying Primary Value

11.13 Profibus® Application Settings

Use the Profibus® toolbar to manage application settings. Tap the **Settings** icon for the following options.

11.13.1 Device Library

The library tab shows the Device Descriptions (DDs) that are on the DPI620G. This lets the user browse for a specific device to find if there is support for it.

To request support for a non-registered DD please contact your local Druck Service center. Refer to Section 1.18.4.

11.13.2 Application Options

Option	Description
Poll header every	Sets the refresh rate for the device parameters displayed in the header.
Poll all dynamic every	Sets the refresh rate for dynamic variables in the folder variables view. Note this setting only becomes valid if the folder variables option "Refresh Vars On" is active.
Enable Device Library Monitor	If checked enables the automatic check of the Open Field Communications DD library on application start up for new Device Descriptions. Note this configuration option requires a network path to the Internet. After installation the default setting is "checked".
Confirm Device Commits	If checked brings up a confirmation dialog before every write is committed to the field device. After installation the default setting is "checked".
Enable My Device Functions	Enables the My Device and Export to DPI620G functions. After installation the default setting is "checked".
Enable Function Blocks	If checked function blocks are enabled. After installation the default setting is "unchecked".
Enable Transducer Blocks	If checked transducer blocks are enabled. After installation the default setting is "checked".

11.13.3 Advanced

These settings are for advanced users only and it is recommended to keep default values.

11.14 Profibus® Function Finder

Function Finder can search for variables and device functions in the online device. In complex devices with multiple menus, this lets the user move through the interface without a manual, greatly simplifying the online experience, even with an unfamiliar device.

The system needs the name of the variable (or part thereof) and the results show all variables that match the search. Navigation to the variable is just a single click in the search results. To start a search, proceed as follows in the online or offline device view:

1. Select the **Search** icon from the Profibus® toolbar.
2. In the "**Name**" field enter the text you wish to search for in the online device. Select return in the keyboard view followed by the **Search** icon to start the search.
3. From the list of results, select the parameter that is required. Note that the variable name and the folder it relates to, is shown.

- Function Finder will then show the related Folder Variables in the Device view with all searched variables highlighted in yellow.



Figure 11-29: Profibus® Function Finder

12. Calibration Procedures

Druck has a calibration service that obeys international standards and thus is traceable.

Druck recommends you send the instrument to the manufacturer or an approved service agent for calibration. If you use an alternative calibration facility, make sure that it uses the standards that are in this chapter. Only approved personnel must calibrate the device.

12.1 Before you start the calibration

Get your parts only from Druck or an approved Druck supplier. To do an accurate calibration of the DPI620G device, use the following:

- Calibration equipment specified in Table 12-1.
- A stable temperature environment: $21 \pm 1^\circ\text{C}$ ($70 \pm 2^\circ\text{F}$).

Keep the equipment in the calibration environment for a minimum of two hours before you start a calibration procedure. Make sure that the time and date on the instrument are correct. Note that the CH1 specification does not apply to the DPI620G-B.

Table 12-1: Calibration Equipment Specification



Function	Calibration Equipment ^a	
	Measure	Source
Current (CH1 or CH2)	Current (mA) calibrator. For accuracy, see Table 12-2,	Current (mA) calibrator. For accuracy, see Table 12-3.
Voltage (CH1)	Voltage calibrator. For accuracy, see Table 12-5.	Voltage calibrator. For accuracy, see Table 12-7.
Voltage (CH2)	Voltage calibrator. For accuracy, see Table 12-5.	–
Millivolts (CH1)	Voltage mV calibrator. For accuracy, see Table 12-4.	Voltage mV calibrator. For accuracy, see Table 12-6.
Millivolts (CH2)	Voltage mV calibrator. For accuracy, see Table 12-4.	–
Millivolts TC mV (CH1)	Voltage mV calibrator. For accuracy, see Table 12-14.	Voltage mV calibrator. For accuracy, see Table 12-14.
Frequency (CH1)	Signal generator. Total error: 0.3 ppm or better	Frequency meter. Total error: 0.3 ppm or better. Resolution: 8 digits (minimum). Voltage calibrator. For accuracy, see Table 12-7.
Resistance (CH1)	Standard resistor (100R, 200R, 300R, 400R, 1k, 2k, 4k). Total uncertainty: 20 ppm or better.	An ohmmeter or an RTD measurement system with the specified excitation currents, refer to Table 12-13.
Cold Junction (CH1)	Calibrated K type thermocouple. Accuracy: 50 mK for -5 to 28°C (23 to 82.4°F)	Accuracy: 50 mK for -5 to 28°C (23 to 82.4°F)
Cold Junction (CH1)	Thermocouple temperature reference unit (0°C). Accuracy: 30 mK	–

Table 12-1: Calibration Equipment Specification

Function	Calibration Equipment ^a	
	Measure	Source
AC mV (CH1)	AC mV calibrator. For accuracy, see Table 12-15.	–
AC Volts (CH1)	AC Volts calibrator. For accuracy, see Table 12-16.	–
Pressure (PM620) Range: 25 mbar (0.36 psi)	Module Carrier MC620G or Pressure Base PV62X. Pressure Calibrator. Total uncertainty of 0.015% reading or better.	–
Pressure (PM620) Range: > 25 mbar (0.36 psi)	Module Carrier MC620G or Pressure Base PV62X. Pressure Calibrator. Total uncertainty of 0.01% reading or better.	–
Pressure (PM620T)	Module Carrier MC620G or Pressure Base PV62X. Pressure Calibrator. Total uncertainty of 0.009% reading or better.	–
Pressure (IDOS)	UPM only. Refer to the user manual K0378, Druck IDOS UPM.	–
Pressure (TERPS)	Refer to the user manual K0473, TERPS.	–
Temperature (RTD Interface)	Standard resistor (100R, 200R, 300R, 400R). Total uncertainty: 20 ppm or better.	–

a. ppm = parts per million.

To do a calibration on a measure or source function, use the **ADVANCED** menu option.

1. Tap the **Settings**  icon on the Dashboard and then tap the **ADVANCED** button.
2. Enter the calibration PIN: 4321
3. Select the tick  icon to show the **CALIBRATION** screen.
4. You have two choices: do an electrical calibration (**PERFORM ELECTRICAL CAL**) or a pressure calibration (**PERFORM PRESSURE CAL**). Tap on the related menu row to select the type of calibration.
5. Select the necessary channel/function from the list.
6. Select the range (if applicable).
7. Follow the instructions on the screen.

- When the calibration is complete, set the next calibration date.

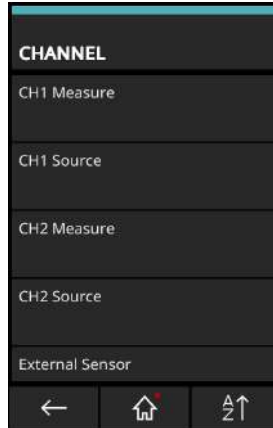

Figure 12-1: Calibration Function and Channel Selection

12.2 Procedures (CH1/CH2): Current (Measure)

When you calibrate measure functions again for this range, an adjustment will affect the related source function calibration. It will be necessary to calibrate the source function again after you adjust the measure function:

- Connect the applicable calibration equipment. Refer to Table 12-1.
- Let the equipment get to a stable temperature (minimum: 5 minutes since the last power on).
- Use the Calibration menu (see Section 12.1) to do a three-point current measure calibration (-FS, Zero and +FS) for each range:
 - 20mA
 - 55mA.

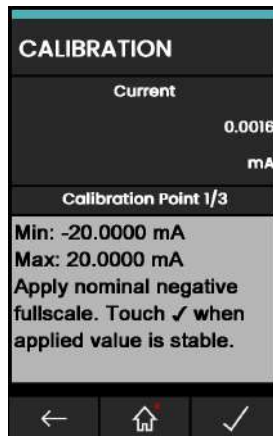

Figure 12-2: Calibration – Current Measure (Range: 20mA)

- Make sure the calibration is correct.
- Make sure that the error is in the specified limits. Refer to Table 12-2:

- a. Select the applicable channel **Current** (measure) function via the **Calibrator Task** menu.
- b. Apply these values:
 mA: -55, -25, -20, -10, -5, 0 (open circuit).
 mA: 0, 5, 10, 20, 25, 55.

Table 12-2: Current (Measure) Error Limits

Applied (mA)	Calibrator Uncertainty (mA)	Permitted DPI620G Error (mA)
± 55	0.00300	0.0055
± 25	0.00250	0.0040
± 20	0.00063	0.0022
± 10	0.00036	0.0016
± 5	0.00025	0.0013
0 (open circuit)	0.00020	0.0010

12.3 Procedures (CH1/CH2): Current (Source)

Follow this procedure:

1. Connect the applicable calibration equipment. Refer to Table 12-1.
2. Let the equipment get to a stable temperature (minimum: 5 minutes since the last power on).
3. **CH1** has only one range (24mA) while **CH2** has two ranges (24mA and -24mA).
4. Use the **Calibration** menu (see Section 12.1) to do a two-point current source calibration (0.2mA and FS) for the relevant channel:
 - **CH1** (one range): 24mA
 - **CH2** (two ranges): 24mA (reverse) and 24mA (forward).

Note: Input positive values for the forward and reverse calibration.

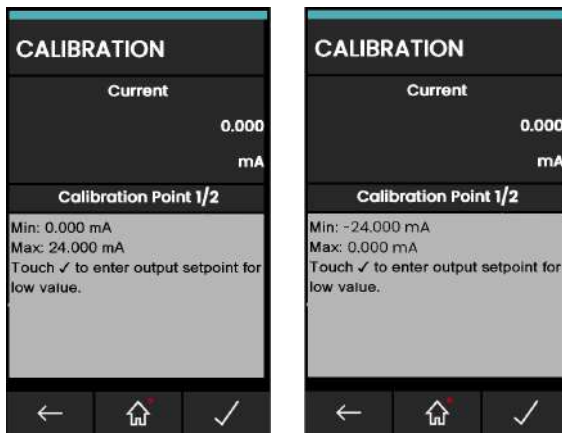

Figure 12-3: Calibration – Current Source (Range: +24mA and -24mA)

5. To make sure the calibration is correct:
 - a. Select the applicable **Current** (source) function via the **Calibrator Task** menu.
 - b. Apply these values: mA: 0.2, 6, 12, 18, 24.

Chapter 12. Calibration Procedures

- c. The error must be in the limit range. Refer to Table 12-3 for these limits.

Table 12-3: Current (Source) Error Limits

Source (mA) ^a	Calibrator Uncertainty (mA)	Permitted DPI620G Error (mA)	Permitted DPI620G-IS Error (mA)
± 0.2	0.00008	0.0010	0.00011
± 6	0.00023	0.0016	0.00132
± 12	0.00044	0.0022	0.00156
± 18	0.00065	0.0028	0.00180
± 24	0.00120	0.0034	0.00204

- a. Negative source values only apply to CH2.

12.4 Procedures (CH1/CH2): DC mV/Volts (Measure)

When you calibrate measure functions again for this range, an adjustment will affect the related source function calibration. It will be necessary to calibrate the source function again after you adjust the measure function:

1. Connect the applicable calibration equipment. Refer to Table 12-1.
2. Let the equipment get to a stable temperature (minimum: 5 minutes since the last power on).
3. Use the calibration menu (see Section 12.1) to do a three-point volts or mV measure calibration (-FS, Zero and +FS) for the applicable set of ranges:
 - a. mV (measure) ranges:
 - 200mV
 - 2000mV
 - b. Volts (measure) ranges:
 - 20V
 - 30V

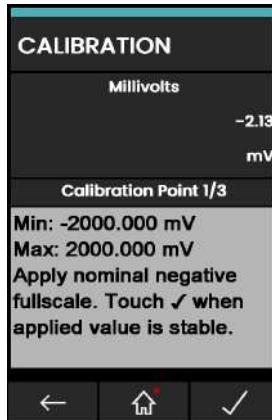

Figure 12-4: Calibration – Millivolts Measure (Range: $\pm 2000\text{mV}$)

4. Make sure the calibration is correct:
 - a. Select the applicable Millivolts or Voltage (measure) function via the **Calibrator Task** menu.
 - b. Apply the input values that are applicable to the calibration:
 - mV: -2000, -1000, -200, -100, 0 (short circuit)
 - mV: 0, 100, 200, 1000, 2000
 - Volts (V): -30, -21, -20, -10, -5, 0 (short circuit)
 - Volts (V): 0, 5, 10, 20, 21, 30
 - c. Make sure that the error is in the limit range. Refer to Table 12-4 or Table 12-5 on the next page.

Table 12-4: Millivolts (Measure) Error Limits

Applied (mV)	Calibrator Uncertainty (mV)	Permitted DPI620G Error (mV)	Permitted DPI620G-IS Error (mV)
± 2000	0.0510	0.1400	0.0900
± 1000	0.0400	0.1000	0.0750
± 200	0.0051	0.0170	0.0109
± 100	0.0040	0.0125	0.0095
0 (short circuit)	0.0036	0.0080	0.0080

Table 12-5: Voltage (Measure) Error Limits

Applied (V)	Calibrator Uncertainty (V)	Permitted DPI620G Error (V)	Permitted DPI620G-IS Error (V)
± 30	0.000520	0.00210	0.00195
± 21	0.000400	0.00180	0.00172
± 20	0.000310	0.00090	0.00090
± 10	0.000160	0.00065	0.00065
± 5	0.000080	0.00053	0.00052
0 (short circuit)	0.000024	0.00040	0.00040

12.5 Procedures (CH1): DC mV/Volts (Source)

Follow this procedure:

1. Connect the applicable calibration equipment. Refer to Table 12-1.
2. Let the equipment get to a stable temperature (minimum: 5 minutes since the last power on).
3. Use the calibration menu (see Section 12.1) to do a two-point volts or mV source calibration (Zero and +FS) for the applicable range:
 - a. mV (source) ranges:
 - 2000 mV.
 - b. Volts (source) ranges:
 - 20 V

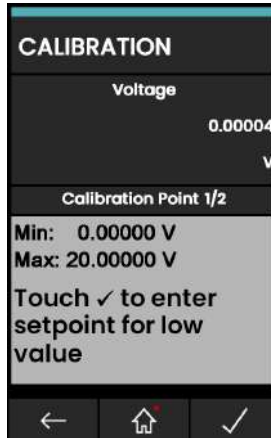

Figure 12-5: Calibration – Voltage Source CH1 (Range: 20 V)

4. Do a check that the calibration is correct:
 - a. Select the applicable **Millivolts** or **Voltage** (measure) function via the **Calibrator Task** menu.
 - b. Apply the input values that are applicable to the calibration:
 - mV: 0, 100, 200, 1000, 2000.
 - Volts (V): 0, 5, 10, 15, 20.
 - c. Do a check that the error is in the limit range. Refer Table 12-6 or Table 12-7.

Table 12-6: Millivolts (Source) Error Limits

Source (mV)	Calibrator Uncertainty (mV)	Permitted DPI620G Error (mV)	Permitted DPI620G-IS Error (mV)
0	0.00010	0.0080	0.0060
100	0.00046	0.0125	0.0090
200	0.00090	0.0170	0.0120
1000	0.00300	0.1000	0.0750
2000	0.00600	0.1400	0.0900

Note: Values in square brackets [] relate to the DPI620G-IS.

Table 12-7: Voltage (Source) Error Limits

Source (V)	Calibrator Uncertainty (V)	Permitted DPI620G Error (V)	Permitted DPI620G-IS Error (V)
0	0.000004	0.00042	[0.00048]
5 [3]	0.000019	0.00070	[0.00060]
10 [6]	0.000034	0.00010	[0.00072]
15 [9]	0.000049	0.00013	[0.00084]
20 [12]	0.000064	0.00160	[0.00096]

12.6 Procedures (CH1): Frequency (Measure or Source)

Only do one frequency calibration: use either the measure function or the source function.

12.6.1 Frequency Calibration (Measure Function)

Use this procedure:

1. Connect the applicable calibration equipment. Refer to Table 12-1.
2. Let the equipment get to a stable temperature (minimum: 5 minutes since the last power on).
3. Set up the equipment as follows:
 - a. Signal generator:
 - Output = 10 V
 - Unipolar
 - Square wave
 - Frequency = 990 Hz.
 - b. DPI620G:
 - Input units = Hz
 - Input trigger level = 5 V.

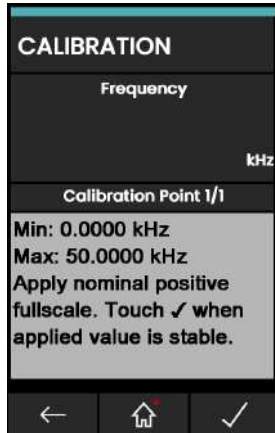

Figure 12-6: Calibration – Frequency Measure CH1 (Range: 50 kHz)

4. Use the **Calibration** menu (see Section 12.1) to do a one-point frequency calibration.

5. Do a check that the calibration is correct.

12.6.2 Frequency Calibration (Source Function)

Do the procedure as follows:

1. Connect the applicable calibration equipment. Refer to Table 12-1.
2. Let the equipment get to a stable temperature (minimum: 5 minutes since the last power on).
3. Set up the equipment as follows:
 - a. Frequency meter:
 - Gate time = one second
 - b. DPI620G:
 - Waveform = Square
 - Amplitude = 10 V
 - Frequency = 990 Hz
4. Use the **Calibration** menu (see Section 12.1) to do a one-point frequency calibration.

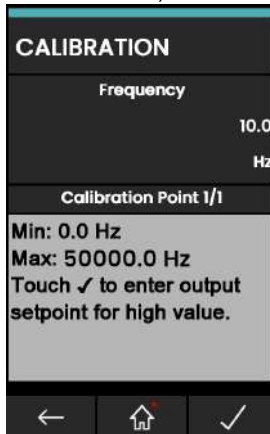

Figure 12-7: Calibration – Frequency Source CH1 (Range: 50 kHz)

5. Do a check that the calibration is correct.

12.6.3 Frequency Calibration Check

1. Frequency (measure) calibration check.
 - a. Signal generator:
 - Output = 10 V
 - Unipolar
 - Square wave
 - b. DPI620G:
 - Input trigger level = 5 V
 - Units: Hz or kHz as specified in Table 12-8 or Table 12-9.
2. Frequency (source) calibration check.
 - a. Frequency meter:
 - Gate time = 1 second.
 - b. DPI620G:

Chapter 12. Calibration Procedures

- Units: Hz or kHz as specified in Table 12-8 or Table 12-9.
3. Select the applicable Frequency measure or source via the **Calibrator Task** menu.
 4. Apply the input values:
 - a. Hz: 0, 990
 - b. kHz: 10, 50.
 5. Do a check that the error is in the limit range. Refer to Table 12-8 or Table 12-9.

Table 12-8: Hz Error Limits (Measure or Source)

Measure/Source (Hz)	Calibrator Uncertainty (Hz)	Permitted DPI620G Error (Hz)	
		(Measure)	(Source)
100	0.0002	0.0023	0.0026
990	0.0005	0.0050	0.0053

Table 12-9: kHz Error Limits (Measure or Source)

Measure/Source (kHz)	Calibrator Uncertainty (kHz)	Permitted DPI620G Error (kHz)	
		(Measure)	(Source)
10	0.00002	0.00023	0.000067
50	0.00002	0.00035	0.000185

12.7 Procedures (CH1): Frequency Amplitude (Source)

Use this procedure:

Note: The procedure that follows, calibrates the “mark” value of the square wave frequency output. The “space” value is fixed and is approximately -120 mV.

1. Connect the applicable calibration equipment. Refer to Table 12-1.
2. Let the equipment get to a stable temperature (minimum: 5 minutes since the last power on).
3. Set up the equipment as follows:
 - Source frequency = 0 (for DC output)
 - Waveform = Square.
4. Use the **Calibration** menu (see Section 12.1) to do a two-point frequency source calibration.
 - Point 1 = 0.2 V
 - Point 2 = 20 V.
5. To a check to find if the calibration is correct:
 - a. Set up the equipment as follows:
 - Source frequency = 0 (for DC output)
 - Waveform = Square.
 - b. Use the amplitude values that are in Table 12-10: these are applicable to the calibration.

This procedure continues on the next page.

- c. Do a check to find if the error is in the limit range. Refer to Table 12-10.

Table 12-10: Amplitude (Source) Error Limits

Amplitude Volts (V)	Calibrator Uncertainty (V)	Permitted DPI620G Error (V)	Permitted DPI620G-IS Error (V)
0.2	0.01 [0.000004]	0.1	[0.1]
5.0 [3]	0.01 [0.000019]	0.1	[0.1]
[6.0]	0.01 [0.000034]	0.1	[0.1]
10.0 [9]	0.01 [0.000049]	0.1	[0.1]
20.0 [12]	0.01 [0.000064]	0.1	[0.1]

12.8 Procedures (CH1): Resistance (Measure)

Use this procedure:

1. Connect the applicable calibration equipment. Refer to Table 12-1.
2. Let the equipment get to a stable temperature (minimum: 5 minutes since the last power on).
3. Use the **Calibration** menu (see Section 12.1) to do a two-point resistance measure calibration:
 - a. Range: 0 - 400Ω
 - Nominal zero ohms - make a 4-wire connection to the 0Ω.
 - Nominal positive full-scale ohms - make a 4-wire connection to the 400Ω resistor.
 - b. Range: 400 Ω - 4kΩ
 - Nominal 400Ω - make a 4-wire connection to the 400Ω resistor.
 - Nominal positive full-scale ohms - make a 4-wire connection to the 4kΩ resistor.

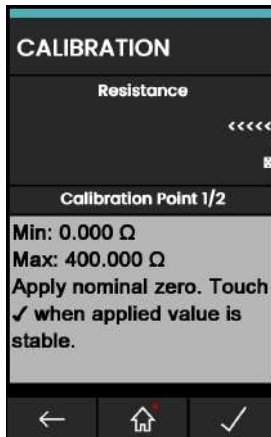

Figure 12-8: Calibration – Resistance Measure CH1 (Range: 400Ω)

4. Do a check to make sure that the calibration is correct:
 - a. Select the applicable **Resistance** (measure) function via the **Calibrator Task** menu.
 - b. Make a 4-wire connection to the applicable standard resistor and measure the value.

Chapter 12. Calibration Procedures

- c. Check the error is within limits. Refer to Table 12-11.

Table 12-11: Resistance (Measure) Error Limits

Standard Resistor (Ω)	Resistor Uncertainty (Ω)	Permitted DPI620G Error (Ω)
0 (short circuit)	–	0.020
100	0.002	0.032
200	0.004	0.044
300	0.006	0.056
400	0.008	0.068
1000	0.020	0.300
2000	0.040	0.410
4000	0.080	0.640

12.9 Procedures (CH1): True Ohms (Measure)

Follow this procedure:

1. Repeat procedure in Section 12.8; in step 3 and 4 select 'True Ohms'.
2. Check the error is within limits. Refer to Table 12-12.

Table 12-12: True Ohms (Measure) Error Limits

Standard Resistor (Ω)	Resistor Uncertainty (Ω)	Permitted DPI620G Error (Ω)	Permitted DPI620G-IS Error (Ω)
0 (short circuit)	–	0.0040	0.0040
100	0.002	0.0095	0.0095
200	0.004	0.0150	0.0150
300	0.006	0.0205	0.0205
400	0.008	0.0260	0.0260
1000	0.020	0.0590	0.0950
2000	0.040	0.1140	0.1500
4000	0.080	0.2240	0.2600

12.10 Procedures (CH1): Resistance (Source)

Use this procedure:

1. Connect the applicable calibration equipment. Refer to Table 12-1.
2. Let the equipment get to a stable temperature (minimum: 5 minutes since the last power on).
3. Use the **Calibration** menu (see Section 12.1) to do a two-point resistance source calibration for each of the following ranges:
 - Range: 0 - 400Ω
 - Range: 400Ω - 2000Ω
 - Range: 2kΩ - 4kΩ

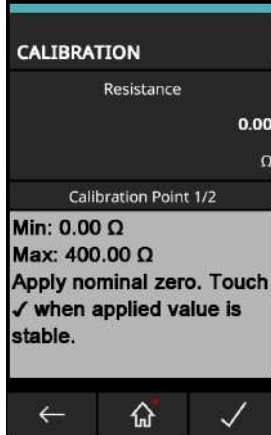

Figure 12-9: Calibration – Resistance Source CH1 (Range: 2000 to 4000Ω)

4. Do a check that the calibration is correct:
 - a. Select the **Resistance** (source) function via the **Calibrator Task** menu.
 - b. Use the resistance values in Table 12-13 that are applicable to the calibration.
 - c. Do a check that the error is in the limit range. Refer to Table 12-13.

Table 12-13: Resistance (Source) Error Limits

Ohms (Ω)	Excitation (mA)	Calibrator Uncertainty (Ω)	Permitted DPI620G Error (Ω)
0	0.1	0.0014	0.014
100	0.1	0.0016	0.038
200	0.1	0.0021	0.062
300	0.1	0.0028	0.086
400	0.1	0.0035	0.110
1000	0.1	0.0080	0.310
2000	0.1	0.0160	0.550
3000	0.1	0.0240	0.860
4000	0.1	0.0320	1.100

12.11 Procedures (CH1): TC mV (Measure or Source)

When you calibrate measure functions again for this range, an adjustment will affect the related source function calibration. It will be necessary to calibrate the source function again after you adjust the measure function:

Note: To make sure calibration is correct when you calibrate the TC mV measure, you must measure the voltage values used at the TC terminals, with the use of the recommended calibration equipment. Refer to Table 12-1.

Use this procedure:

1. Connect the applicable calibration equipment. Refer to Table 12-1.
2. Let the equipment get to a stable temperature (minimum: 5 minutes since the last power on).
3. Use the **Calibration** menu (see Section 12.1) to do a three-point TC mV measure/source calibration with the following points:
 - mV: -10, 0, 100.

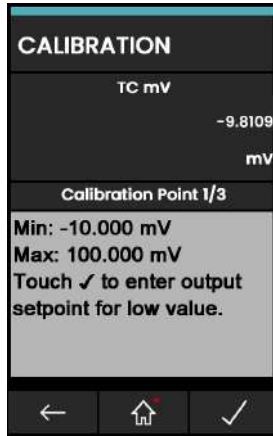

Figure 12-10: Calibration – TC mV Measure CH1 (Range: ± 100 mV)

4. Do a check that the calibration is correct:
 - a. Use the **Calibrator Task** menu to select the applicable TC mV (measure) or (source).
 - b. Use these values:
 - TC mV (measure): -10, 0 (short circuit)
 - TC (mV): 10, 25, 50, 100
 - TC mV (source): -10, 0, 10, 25, 50, 100.
5. Do a check that the error is in the limit range. Refer to Table 12-14.

Note: Values in square brackets [] relate to the DPI620G-IS.

Table 12-14: TC mV (Measure or Source) Error Limits

Input or Output TC (mV)	Calibrator Uncertainty TC (mV)		Permitted DPI620G Error TC (mV)	
	(Measure)	(Source)	(Measure)	(Source)
-10	0.0036	0.00011	0.0085 [0.0080]	0.0090 [0.0085]
0	0.0036	0.00010	0.0080 [0.0080]	0.0080 [0.0080]
10	0.0036	0.00011	0.0085 [0.0080]	0.0090 [0.0085]

Table 12-14: TC mV (Measure or Source) Error Limits

Input or Output TC (mV)	Calibrator Uncertainty TC (mV)		Permitted DPI620G Error TC (mV)	
	(Measure)	(Source)	(Measure)	(Source)
25	0.0036	0.00015	0.0091 [0.0080]	0.0100 [0.0091]
50	0.0037	0.00025	0.0100 [0.0080]	0.0125 [0.0103]
100	0.0040	0.00046	0.0125 [0.0080]	0.0170 [0.0125]

12.12 Procedures (CH1): Cold Junction (TC Method) and CJ (Measure)

Note: Do the TC mV (measure) calibration before the CJ (Cold Junction) calibration. The conditions for CJ calibration are:

- Battery mode (with DC charger disconnected).
- **CH1** active (TC or TC mV).
- **CH2** set to “None”.
- Set **Burnout Detection** to **Off** (in **CH1 TC** settings).
- Use miniature TC connectors.

There are two methods to do a cold junction test: the CJ (TC Method) is the preferred method. Both procedures are as follows:

12.12.1 Cold Junction (TC Method)

Follow this procedure:

1. Connect the applicable calibration equipment. Refer to Table 12-1.
2. Set the reference unit temperature: 0°C.
3. Let the equipment get to a stable temperature (minimum: 1 hour since the last power on).
4. Use the **Calibration** menu (see Section 12.1) to do a one-point calibration for the CJ (TC method) function.
5. Calculate the expected reading: use the known error in the thermocouple and reference unit.
6. Do a check that the calibration is correct:
 - a. Use the **Calibrator Task** menu to select the TC measure function.
 - b. Do a check that the equipment gives a TC temperature that is the same as the temperature on the reference unit $\pm 0.1^\circ\text{C}$ (0.2°F), after correction for the known thermocouple and reference unit error.

12.12.2 Cold Junction (Alternative Method)

Follow this procedure:

1. Connect the applicable calibration equipment. Refer to Table 12-1.
2. Set up the equipment:
 - Function = TC (measure)
 - TC Type = K Type
 - CJ Compensation, Mode = Automatic.
3. Set the reference unit temperature: 0°C.
4. Let the equipment get to a stable temperature (minimum: 1 hour since the last power on).
5. Record the values that occur:
 - TC temperature given on the reference unit T (actual).

Chapter 12. Calibration Procedures

- TC temperature given on the calibrator T (measured).
 - CJ temperature given on the calibrator CJ (measured).
6. Calculate the CJ (Cal Value) as follows:
 - $CJ \text{ (Cal Value)} = CJ \text{ (measured)} - T \text{ (actual)} + T \text{ (measured)}$.
 7. Use the **Calibration** menu to do a one-point calibration for the CJ (measure) function.
 8. When the display shows "**Sampling complete**", set the correct Cal Value = CJ (Cal Value) in step 6.
 9. To make sure that the calibration is correct:
 - a. Use the **Calibrator Task** menu to select the TC (measure) function.
 - b. Do a check that the equipment gives a TC temperature that is the same as the temperature on the reference unit $\pm 0.1^\circ\text{C}$ (0.2°F).

12.13 Procedures (CH1): AC mV/Volts (Measure)

Note: This procedure does not apply to the DPI620G-IS.

Follow this procedure:

1. Connect the applicable calibration equipment. Refer to Table 12-1.
2. Let the equipment get to a stable temperature (minimum: 5 minutes since the last power on).
3. Use the **Calibration** menu (see Section 12.1) to do a two-point AC calibration for the applicable AC function.
 - Use the local power supply frequency.
 - For the AC mV (measure) function:
 - point 1 = 200.0mV AC
 - point 2 = 2000.0mV AC
 - For the AC Volts (measure) function:
 - point 1 = 2.000V AC
 - point 2 = 20.000V AC
4. Do a check that the calibration is correct:
 - a. Use the **Calibrator Task** menu to select the applicable AC mV or AC Volts (measure) function.
 - b. Use these input values that are applicable to the Calibration:
 - AC mV: 10, 500, 1000, 2000
 - AC Volts: 5, 10, 20.
 - c. Do a check that the error is in the limit range. Refer to Table 12-15 or Table 12-16.

Table 12-15: AC mV (Measure) Error Limits

Applied AC (mV)	Calibrator Uncertainty (mV)	Permitted DPI620G Error (mV)
10	0.12	2.50
500	0.20	3.10
1000	0.28	3.75
2000	0.44	5.00

Table 12-16: AC Volts (Measure) Error Limits

Applied AC Volts (V)	Calibrator Uncertainty (V)	Permitted DPI620G Error (V)
5	0.0018	0.030
10	0.0026	0.037
20	0.0042	0.050

12.14 Procedures: Pressure Module

Note: This procedure is suitable for PM620, PM620T or IDOS UPM pressure modules.

Follow this procedure:

1. Assemble the pressure indicator with the necessary pressure module.
2. Connect the instrument to the pressure standard.
3. Let the equipment get to a stable temperature (minimum: 1 hour since the last power on).
4. Use the **Calibration** menu (see Section 12.1) to do a two-point pressure calibration (absolute sensors) or three-point pressure calibration (gauge sensor).
 - -FS, Zero and +FS for gauge sensors.
 - Zero and +FS for absolute sensors.

Note: If the software version requires a three-point calibration for an absolute sensor, use points at 0, 50% and +FS or three-point calibration. Refer to Table 12-17 or Table 12-18.

Table 12-17: Calibration Pressures (Gauge Sensors)

Pressure Range mbar (psi)	Nominal Applied Pressure mbar (psi)		
	-FS ^a	Zero	+FS
< 700 mbar (10.0)	-FS	0	+FS
> 700 mbar (10.0)	-900 (-13.1)	0	+FS

- a. For a three-point calibration, do not apply more than -90% of the specified FS for the unit.

Table 12-18: Calibration Pressures (Absolute Sensors)

Pressure Range bar (psi)	Nominal Applied Pressure mbar (psi)	
	Zero	+FS
350mbar (5.0)	< 1.0 (0.02)	+FS
2bar (30.0)	< 5.0 (0.07)	+FS
7bar (100.0)	< 20.0 (0.29)	+FS
20bar (300.0)	< 50.0 (0.73)	+FS
350bar (5000)	Use atmospheric pressure as zero.	+FS

Chapter 12. Calibration Procedures

5. Do a check that the calibration is correct:
 - a. Use the **Calibrator Task** menu to select the applicable pressure function.
 - b. Use these pressure values for absolute sensors:
%FS: 0, 20, 40, 60, 80, 100
%FS: 100, 80, 60, 40, 20, 0.
 - c. Use these pressure values for gauge sensors:
%FS: 0, 20, 40, 60, 80, 100
%FS: 100, 80, 60, 40, 20, 0.
 - d. Do a check that the error is in the limit range.
 - e. Refer to the sensor datasheet and use the values in the total uncertainty column.
 - f. The specified values include an allowance for temperature changes, reading stability for one year, and the uncertainty of the standard used for calibration.

12.15 Procedures: TERPS USB

Refer to the user manual K0473, Druck TERPS. Refer to Section 12.14 for the procedure.

When the calibration is complete, the instrument automatically sets a new calibration date in the sensor.

12.16 Procedures: RTD-INTERFACE

Follow this procedure:

1. Connect the RTD-Interface to the DPI620G.
2. Connect the RTD probe to the temperature standard.
3. Let the equipment get to a stable temperature (minimum: 1 hour since the last power on).
4. Use the **Calibration** menu (see Section 12.1) to do a two-point temperature (resistance) measure calibration (0 to 400 Ω range):
 - Zero and +FS

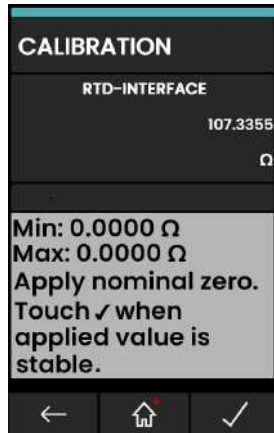

Figure 12-11: Calibration – RTD-INTERFACE

This procedure continues on the next page.

5. Do a check that the calibration is correct:
 - a. Select the applicable RTD-Interface measure function via the **Calibrator Task** menu.
 - b. Use these values:
%FS: 0, 25, 50, 75, 100
 - c. Do a check that the error is in the limit range. Refer to Table 12-19.

Table 12-19: RTD Resistance (Measure) Error Limits

Applied Resistance (Ω)	Calibrator Uncertainty (Ω)	Permitted DPI620G Error (Ω)
0	0.0020	0.020
100	0.0020	0.032
200	0.0029	0.044
300	0.0041	0.056
400	0.0052	0.068

13. General Specification

For a full specification of the Druck DPI620G calibrator and its related accessories (MC620G module carrier, PM620 or PM620T pressure module and PV62X pressure station), refer to the relevant product datasheet. The DPI620G is applicable to indoor use with the following environmental requirements. It is also permitted to use outdoors as a portable instrument if these environmental requirements are met.

Item	Description
Display	LCD: Color display with touchscreen.
Operating Temperature	-10 to 50°C (14 to 122°F)
Storage Temperature	Device: -20 to 70°C (-4 to 158°F) Battery: -20 to 40°C (-4 to 104°F)*
Ingress Protection	IP54 (Druck DPI620G-IS). IP55 (Druck DPI620G)
Humidity	0 to 90% relative humidity (RH) non-condensing.
Maximum Altitude	3000m
Shock/Vibration	MIL-PRF-28800F for class 2 equipment.
Pollution Degree	2
EMC	Electromagnetic Compatibility: EN 61326-1:2013
Electrical Safety	Electrical: EN 61010:2010 Electrical: EN 62368-1:2014 + A11:2017. (Charger PSU Only).
Pressure Safety	Pressure Equipment Directive - Class: Sound Engineering Practice
Approved	CE Marked
Battery Power	DPI620G/-B. (IO620-BATTERY) Nominal voltage: 3.7V. Capacity: DPI620G/-B. 4800mAh (Li-Polymer). Charge temperature*: DPI620G/-B. 0 to 45°C (32 to 113°F). The battery will not receive a charge if the temperature goes out of the limits. Discharge Temperature -10 to 50 degrees C. Charge/discharge cycles: >500 >70% capacity. DPI620G-IS (IO620G-IS-BATTERY) Nominal Voltage 3.65V. Capacity: DPI620G-IS. 4000mAh (Li-Ion). Charge temperature*: DPI620G-IS. 0 to 40°C (32 to 104°F). The battery will not receive a charge if the temperature goes out of the limits. Discharge temperature: -10 to 60°C (14 to 140°F).

Note: The DPI620G has been assessed to the European IEC 60529 standard as having an ingress protection rating of IP55. The IP for the DPI620G-IS is IP54. But these are for reliability purposes and not for safety reasons.

Note: To meet the immunity requirements of annex A of EN 61326-1:2006, when used in an industrial environment, the unit must be battery powered to guarantee accurate measurements.

Note: The case of the DPI620G is not suitable for prolonged exposure to UV.

Note: * Battery temperature. Long time exposure to temperature extremes can decrease battery life. For maximum life, do not expose the battery to temperatures outside the range -20°C to +40°C for long periods. The recommended storage temperature range is -20°C to 25°C.

Note: The DPI620G is not suitable for permanent installation in an outdoor environment.

Appendix A. COMPLIANCE STATEMENTS

A.1 FCC (USA)

Federal Communication Commission Interference Statement

This equipment has been tested and found to comply with the limits for a Class B digital device, pursuant to Part 15 of the FCC Rules. These limits are designed to provide reasonable protection against harmful interference in a residential installation. This equipment generates, uses, and can radiate radio frequency energy and, if not installed and used in accordance with the instructions, may cause harmful interference to radio communications.

However, there is no guarantee that interference will not occur in an installation. If this equipment does cause harmful interference to radio or television reception, which can be determined by turning the equipment off and on, the user is encouraged to try to correct the interference by one of the following measures:

- Reorient or relocate the receiving antenna.
- Increase the separation between the equipment and receiver.
- Connect the equipment into an outlet on a circuit different from that to which the receiver is connected.
- Connect the equipment into an outlet on a circuit different from that to which the receiver is connected.

FCC Caution: Any changes or modifications not expressly approved by the party responsible for compliance could void the user's authority to operate this equipment.

This device complies with Part 15 of the FCC Rules. Operation is subject to the following two conditions:

1. This device may not cause harmful interference; and,
2. This device must accept any interference received, including interference that may cause undesired operation.

FCC Radiation Exposure Statement

This product complies with the US portable RF exposure limit set forth for an uncontrolled environment and is safe for intended operation as described in this manual. Further RF exposure reduction can be achieved if the product is kept as far as possible from the user body or is set to a lower output power if such function is available.

This transmitter must not be co-located or operated in conjunction with any other antenna or transmitter.

Appendix A. COMPLIANCE STATEMENTS

A.2 CANADA

ISED Canada Statement

This device complies with Industry Canada's license-exempt RSSs. Operation is subject to the following two conditions:

1. This device may not cause interference; and
2. This device must accept any interference, including interference that may cause undesired operation of the device.

Le présent appareil est conforme aux CNR d'Industrie Canada applicables aux appareils radio exempts de licence. L'exploitation est autorisée aux deux conditions suivantes:

1. l'appareil ne doit pas produire de brouillage;
2. l'utilisateur de l'appareil doit accepter tout brouillage radioélectrique subi, même si le brouillage est susceptible d'en compromettre le fonctionnement.

Radiation Exposure Statement

The product complies with the Canada portable RF exposure limit set forth for an uncontrolled environment and are safe for intended operation as described in this manual. The minimum separation distance for portable use is limited to 15mm assuming use of antenna with 2dBi of gain. The further RF exposure reduction can be achieved if the product can be kept as far as possible from the user body or set the device to lower output power if such function is available.

Déclaration d'exposition aux radiations

Le produit est conforme aux limites d'exposition pour les appareils portables RF pour les Etats-Unis et le Canada établies pour un environnement non contrôlé. La distance de séparation minimale pour l'utilisation portative est limitée à 15mm en supposant l'utilisation de l'antenne avec 2 dBi de gain. Le produit est sûr pour un fonctionnement tel que décrit dans ce manuel. La réduction aux expositions RF peut être augmentée si l'appareil peut être conservé aussi loin que possible du corps de l'utilisateur ou que le dispositif est réglé sur la puissance de sortie la plus faible si une telle fonction est disponible.

Office Locations



Services and Support Locations

