

# Druck DPI 620

## advanced modular calibrator

safety and quick reference guide - K0454



### A1.1 DPI 620: Channel 1 (CH1)

Measure (M) / Source (S) / Power (P)		
a	±30 V (M)	Figure C1 <b>Note:</b> ⚡ = See figure or table.
b	0 to 12 V (S)	
c	±2000 mV (M) 0 to 2000 mV (S)	
d	0 to 4000 Ω (M/S)	
e	0 to 50 kHz (M/S)	
f	Switch (M) ⚡	
g	±55 mA (M)	Figure C2
h	0 to 24 mA (S)	
i	11 RTDs (M/S)	Figure C3 (2, 3, 4-wire)
j	12 TCs (M/S)	Figure C4
k	±300 Vac: AC probe	Figure C5 (Part: IO620-AC)

### A1.2 DPI 620: Channel 2 (CH2)

l	±30 V (M)	Figure D1
m	±2000 mV (M)	
n	±55 mA (M)	
o	0 to 24 mA (S)	
p	24 V loop (P)	
q	Switch (M) ⚡	

### A1.3 DPI 620 + MC 620 + PM 620

Pressure* (M)	Figure E1
Gauge: 25 mbar to 200 bar (0.36 to 3000 psi) Absolute: 350 mbar to 1000 bar (5 to 15000 psi)	
<b>Note:</b> Maximum pneumatic pressure: 500 bar (7250 psi)	

**\*Caution:** To prevent damage to the PM 620 module, only use it within the specified pressure limit on the label.

© 2008 General Electric Company. All rights reserved.

Trademarks

All product names are trademarks of their respective companies.

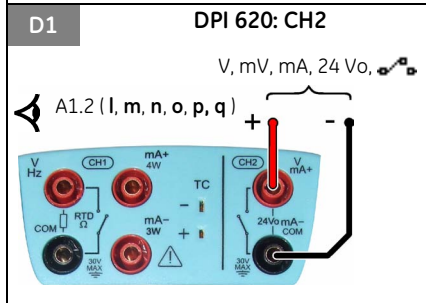
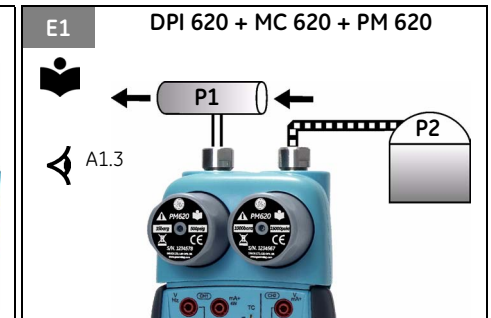
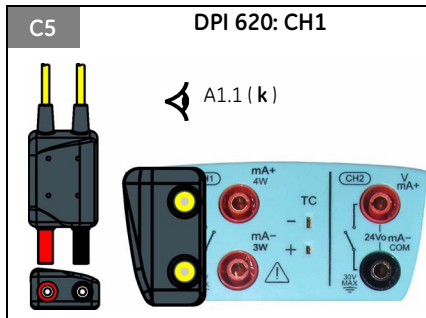
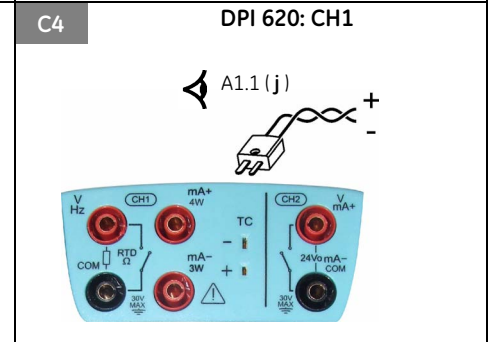
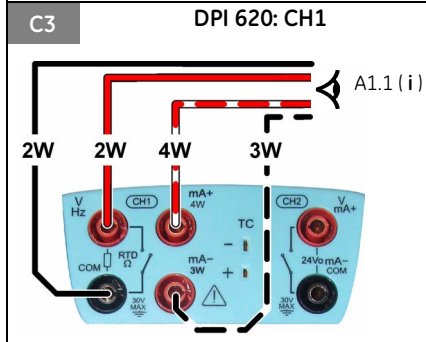
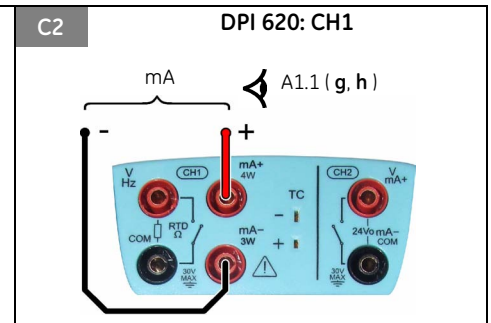
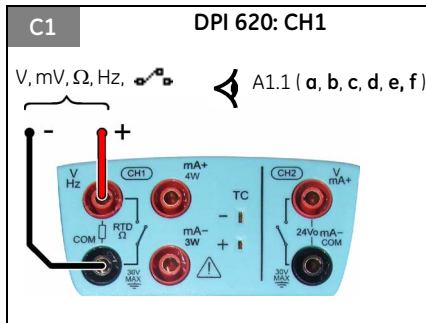
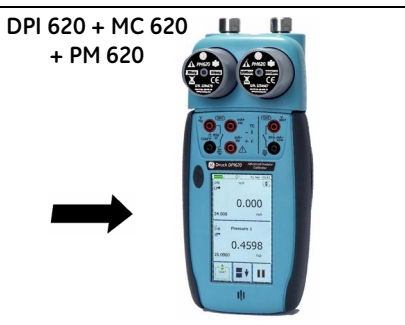
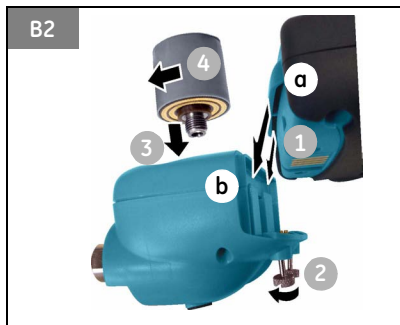
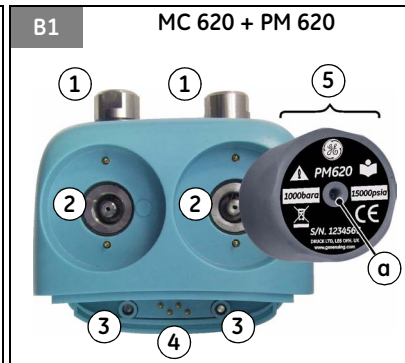
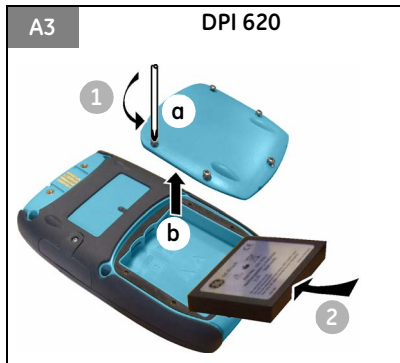
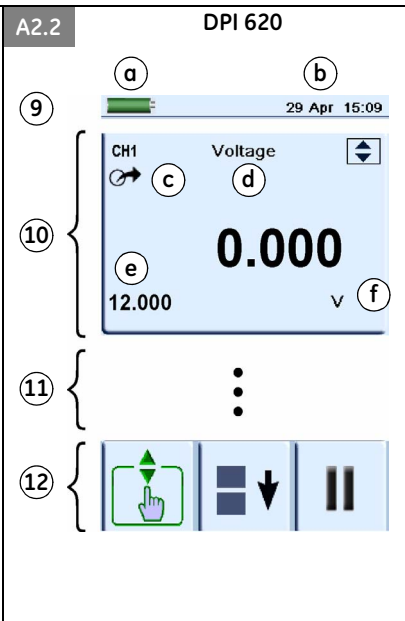
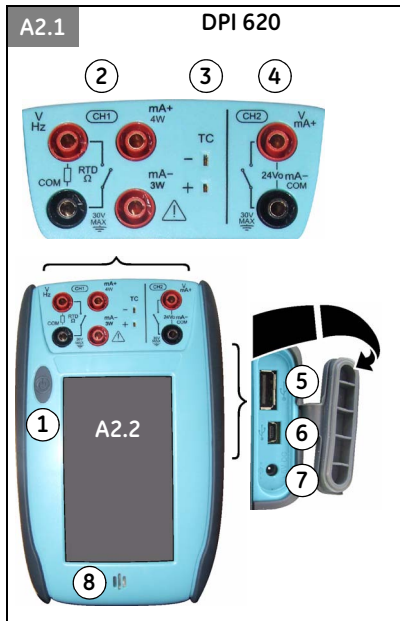

## Quick Reference

**WARNING:** Before you use this instrument, read and understand the “Safety” section. It is dangerous to ignore the specified warnings.

### Start operations (S1 to S4)

**S1:** *Install the battery.* Refer to Section 5.

**S2:** *Power on/off sequence*

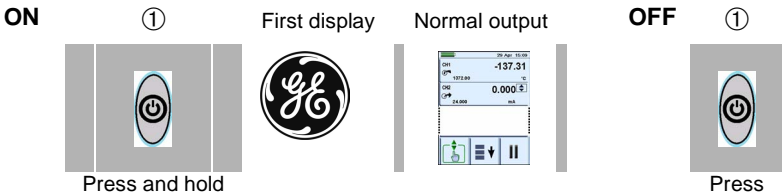

**S3:** *Example change of function (Voltage to Current)*

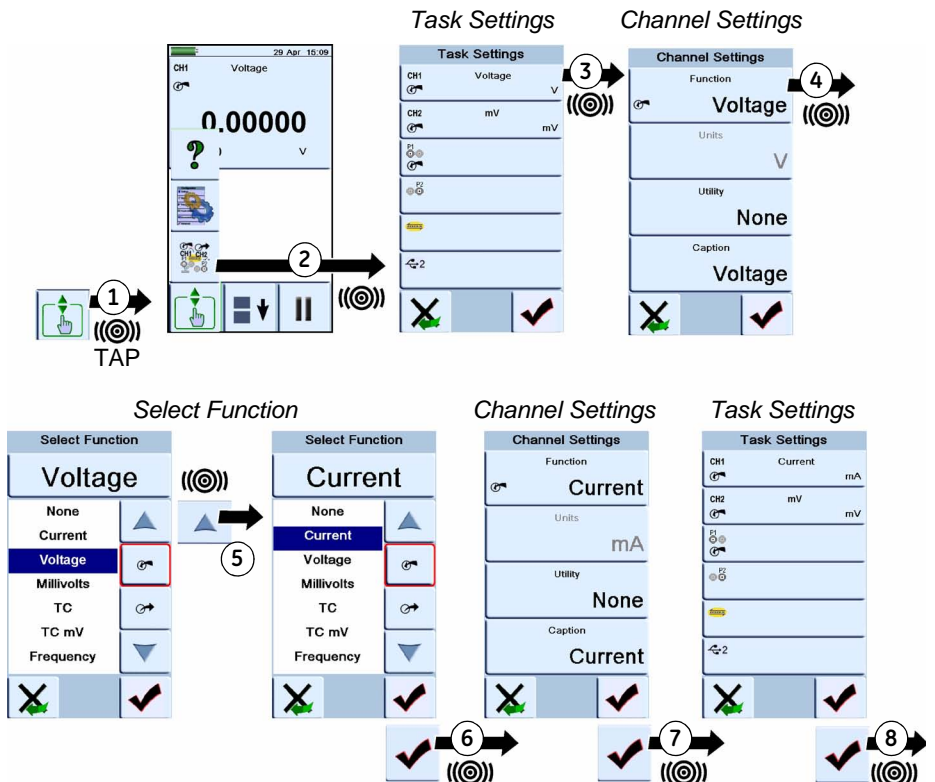

**S4: Touch-screen operations (maximise, minimise, set voltage)**

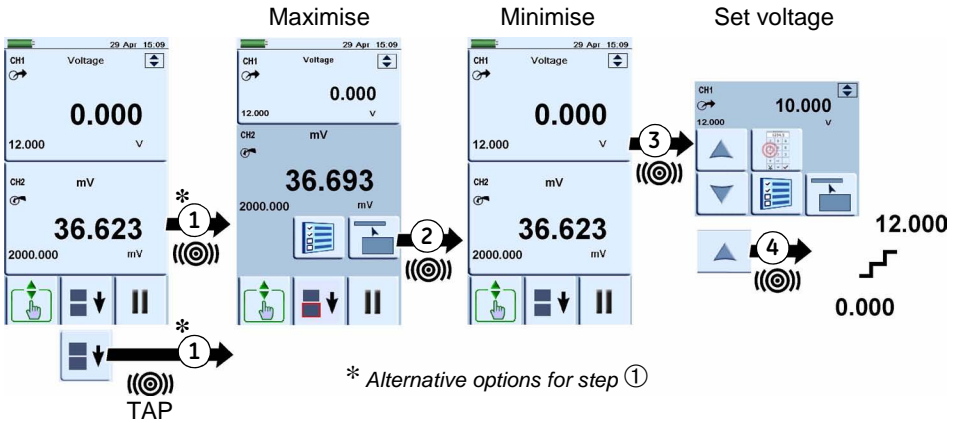

**Menu sequence**

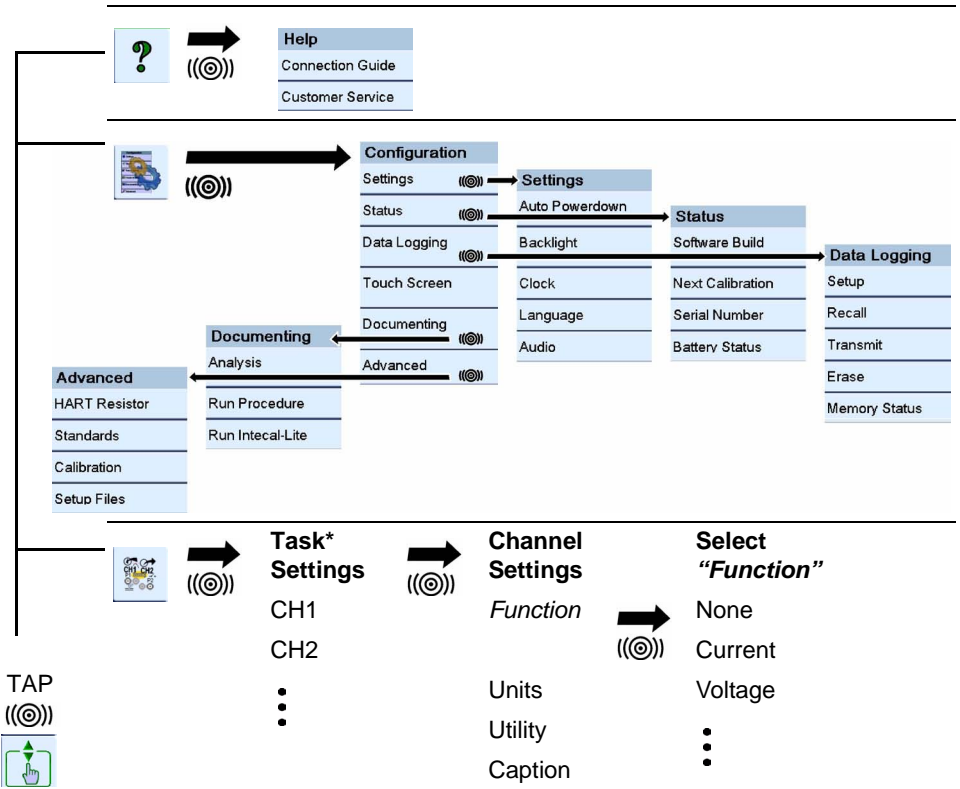

---

## 1 Overview

The advanced modular calibrator (AMC) is part of a set of hand-held modules that you can quickly put together to include a wide range of calibrator functions.



**Advanced modular calibrator, DPI 620:** This is a battery-powered instrument for electrical measure and source operations and HART® communications; see table A1 (front cover). It also supplies the power and user interface functions for all the add-on modules. You can use the touch-screen to display up to six different parameters.



**Pressure module carrier, MC 620:** *Optional item.* This attaches to the DPI 620 calibrator to make a fully integrated pressure indicator instrument. To measure and display pneumatic or hydraulic pressures, you can have up to two interchangeable pressure transducers at a time.



**Pressure modules, PM 620:** *Optional item.* These modules attach to the pressure module carrier (MC 620) or to a pressure station (PV 62x) to give the DPI 620 calibrator the necessary pressure measurement functionality. They are fully interchangeable “plug and play” modules with no initial set-up or user calibration.



**Pressure stations, PV 62x:** *Optional item.* To make a fully integrated pressure calibrator, you can attach the DPI 620 calibrator to one of the three pressure stations. Refer to user manual - K0457.

---

## 2 Standard equipment

These items are part of the standard equipment with the DPI 620 calibrator:

- DC power supply/battery charger unit
- Li-Polymer battery
- Set of six electrical test leads
- Safety and quick reference guide
- CD with the user manual

---

### 3 Safety

Before you use the instrument, make sure that you read and understand all the related data. This includes: the applicable local safety procedures, the user manual (K0449), and the instructions for the accessories/options/equipment you are using it with.

#### *General warnings*

---

#### **⚠ WARNING ⚠**

---

- **It is dangerous to ignore the specified limits for the instrument or to use the instrument when it is not in its normal condition. Use the applicable protection and obey all safety precautions.**
- **Do not use the instrument in locations with explosive gas, vapour or dust. There is a risk of an explosion.**

#### *Electrical warnings*

- 
- **To prevent electrical shocks or damage to the instrument, do not connect more than 30V between the terminals, or between the terminals and the ground (earth).**
  - **To prevent electrical shocks, use only the GE specified AC probe (Part: IO620-AC) to measure AC voltages (maximum: 300 Vac).**
  - **This instrument uses a Lithium-Polymer (Li-Polymer) battery pack. To prevent an explosion or fire, do not short circuit, do not disassemble, keep it safe from damage. For operating conditions, see Table 1.**
  - **To prevent an explosion or fire, use only the GE specified battery, power supply and battery charger.**
  - **To prevent battery leakage or heat generation, only use the battery charger and power supply in the temperature range 0 to 40°C (32 to 104°F). For operating conditions, see Table 1.**

#### *Pressure warnings*

- 
- **Some liquid and gas mixtures are dangerous. This includes mixtures that occur because of contamination. Make sure that the equipment is safe to use with the necessary media.**
  - **To prevent a dangerous release of pressure, isolate and bleed the system before you disconnect a pressure connection.**

*Continued*

- To prevent a dangerous release of pressure, make sure that all the related pipes, hoses and equipment have the correct pressure rating, are safe to use and are correctly attached.







## Cautions

**To prevent damage to the display, do not use sharp objects on the touch-screen.**

**To prevent damage to the PM 620 module, only use it within the specified pressure limit on the label.**

Before you start an operation or procedure in this publication, make sure that you have the necessary skills (if necessary, with qualifications from an approved training establishment). Follow good engineering practice at all times.

## Marks and symbols on the instrument

	Complies with European Union directives		Warning - refer to the manual
	Read the manual		USB ports: Type A; Mini-type B connector
	Ground (Earth)		ON/OFF
	Do not dispose of this product as household waste. Refer to "Maintenance" (Section 5.5).		
More marks and symbols are specified in the user manual (K0449 - Druck DPI 620 Advanced modular calibrator)			





## 4 Parts

Refer to the figures on the front cover (A2, B1).

### 4.1 Key to figure A2 (DPI 620 calibrator)

A2	1.		On or off button. Refer to "Quick Reference".
	2.	CH1	Channel 1 connectors for: voltage (V); frequency (Hz); resistance ( $\Omega$ ); resistance temperature detectors (RTD): 3W, 4W = 3-wire, 4-wire RTD input; switch operation; current (mA+, mA-); COM = Common connector  You can also use the GE specified AC probe (Part: IO620-AC) to measure AC voltages (maximum: 300 Vac).
	3.	TC	Channel 1 connectors for thermocouples.
	4.	CH2	Isolated channel 2 connectors for: voltage (V); current (mA+, mA-); 24V loop power supply (24Vo); switch operation

A2

5.		USB type A connector for connections to external peripherals (USB flash memory or optional external modules).
6.		USB mini-type B connector for communication with a computer.
7.		+5V DC power input socket. This supply also charges the battery.
8.		Sealed speaker unit.
9.		Liquid crystal display (LCD): Colour display with touch-screen. To make a selection, lightly tap on the applicable display area. <b>a.</b> Battery indicator <b>b.</b> Date and time
10.		CH1: Window for the channel 1 settings and values. <b>c.</b> Measure or source indication <b>d.</b> Function <b>e.</b> Full scale (FS) range <b>f.</b> Function units
11.		Other windows: The number of windows you see on the display is set by the number of task selections and external modules you are working with (maximum: 6).
12.		Tap this button to set up the <i>Task</i> , set up the instrument ( <i>Configure</i> ) and to access Help (?). Refer to “Quick Reference”.
		Tap this button to maximise each of the available windows in sequence. Refer to “Quick Reference”.
		<i>Pause</i> (  ) or <i>Play</i> (▶): Tap (  ) to hold (freeze) all the data on the display. To release the display and continue, tap (▶).

#### 4.2 Key to figure B1 (MC 620 module carrier/PM 620 module) - Optional item

B1

1.		Pressure connection (G1/8 or 1/8NPT) to attach external pressure equipment.
2.		Pressure and electrical connections for a pressure module (PM 620). These are self-seal pressure connections.
3.		Two screws to attach the calibrator (DPI 620).
4.		Electrical connections for the calibrator (DPI 620).
5.		Pressure module (PM 620) with a pressure connection, reference port (a) and a label. The label includes: <i>Pressure range</i> . Example: 20 bar g (g: gauge; a: absolute); <i>serial number (S/N)</i> ; <i>manufacturer</i> : name, address, website



## 5 Installation

Before you start:

- Read and understand the “Safety” section.
- Do not use damaged equipment.

**Note:** Use only original parts supplied by the manufacturer.

### 5.1 AMC battery

See figure A3 (front cover).

A3	Step	Procedure
	1.	When the power is off, loosen the five screws (a) and remove the cover (b).  If necessary, turn the instrument over and let the discharged battery drop into your hand.
	2.	Install the new battery correctly until it is flat in the compartment.
	3.	Re-attach the cover.

### 5.2 Indicator assembly

*Optional item (MC 620/PM 620).* See figure B2 (front cover).

B2	Step	Procedure
	1.	Align the two slots (a) on the calibrator with the two posts (b) on the module carrier.
	2.	When the posts are fully engaged in the slots, tighten the two screws until they are hand tight.
	3.	Attach one or two PM 620 modules with the correct range and type.
	4.	Tighten each one until it is hand tight only.

### 5.3 Electrical connections

See figure C1 to C5, and D1 (front cover).

### 5.4 External pressure connections

See figure B1/E1 (front cover). Use an applicable method to seal the external pressure connections, and then tighten to the applicable torque. Maximum torque:

1/8 NPT: 35 Nm (26 lbf.ft)

G1/8: 25 Nm (18.4 lbf.ft)

## 5.5 Maintenance

Clean the case with a moist, lint-free cloth and a weak detergent. Do not use solvents or abrasive materials.

Return the instrument to the manufacturer or an approved service agent for all repairs. Refer to the user manual.

Do not dispose of this product as household waste. Use an approved organisation that collects and/or recycles waste electrical and electronic equipment. For more information, contact one of these:

- our customer service department:  
(Contact us at [www.gesensing.com](http://www.gesensing.com))
- your local government office.

---

## 6 Specification

**Table 1: General specification**

Display	LCD: Colour display with touch-screen
Operating temperature	-10 to 50°C (14 to 122°F)
Storage temperature	-20 to 70°C (-4 to 158°F)
Ingress Protection	IP65 (DPI 620 calibrator only)
Humidity	0 to 90% relative humidity (RH) non-condensing
Shock/Vibration	Def Stan 66-31, 8.4 cat III
EMC	Electromagnetic compatibility: BS EN 61326-1:2006
Electrical safety	Electrical - BS EN 61010:2001
Pressure safety	Pressure Equipment Directive - Class: Sound Engineering Practice (SEP)
Approved	CE Marked
Battery power	Lithium-Polymer battery (GE Part number: 191-356) Capacity: 5040 mAh (minimum), 5280 mAh (typical); Nominal voltage: 3.7 V. Charge temperature: 0 to 40°C (32 to 104°F) <b>Note:</b> When the instrument senses the temperature is outside this range, it stops charging. Discharge temperature: -10 to 50°C (14 to 122°F). Charge/discharge cycles: > 500 > 70% capacity

## **Customer service**

Visit our web site: [www.gesensing.com](http://www.gesensing.com)