



doc.metrel.si



www.metrel.si/newsletter



www.metrel.si/academy



EurotestCOMBO XC
MI 3136
Instruction manual
Version 1.2.2, Code no. 20 753 493

Distributor:

Manufacturer:

Metrel d.o.o.
Ljubljanska cesta 77
SI-1354 Horjul
[e-mail: info@metrel.si](mailto:info@metrel.si)
<https://www.metrel.si>

DATA BACKUP AND LOSS:

It is the user's responsibility to ensure the integrity and security of the data carrier and to regularly backup and validate the integrity of backups of the data. METREL HAS NO OBLIGATION OR LIABILITY FOR ANY LOSS, ALTERATION, DESTRUCTION, DAMAGE, CORRUPTION OR RECOVERY OF USER DATA, REGARDLESS OF WHERE THE DATA IS STORED.



Mark on your equipment certifies that it meets requirements of all subjected EU regulations.



Hereby, Metrel d.o.o. declares that the MI 3136 is in compliance with Directive 2014/53/EU (RED) and all other subjected EU directive. The full text of the EU declaration of conformity is available at the following internet address <https://www.metrel.si/DoC>.



Mark on your equipment certifies that it meets requirements of all subjected UK regulations.



Hereby, Metrel d.o.o. declares that the MI 3136 is in compliance with Radio Equipment Regulations 2017 and all other subjected UK regulations. The full text of the UK declaration of conformity is available at the following internet address <https://www.metrel.si/UK-DoC>.

© Metrel d.o.o.

Published: 05/2026

No part of this publication may be reproduced or utilized in any form or by any means without permission in writing from *Metrel*.

Table of Contents

1	General description	6
1.1	Warnings and notes	6
1.1.1	<i>Safety warnings</i>	6
1.1.2	<i>Warnings related to batteries</i>	7
1.1.3	<i>Warnings related to safety of measurement functions</i>	7
1.1.4	<i>Notes related to measurement functions</i>	8
1.1.5	<i>Markings on the instrument</i>	9
1.1.6	<i>Note related to measurement procedure</i>	10
1.1.7	<i>General notes</i>	10
1.2	Testing for dangerous voltages at the PE terminal	10
1.3	Battery and charging of Li-ion battery pack	12
1.3.1	<i>Li - ion battery pack guidelines</i>	12
1.4	Standards applied	12
2	Instrument set and accessories	14
2.1	Basic set of the instrument	14
2.2	Optional accessories	14
3	Instrument description	15
3.1	Front panel	15
3.2	Bottom side	16
3.2.1	<i>Battery / fuse compartment</i>	17
4	Instrument operation	18
4.1	General meaning of keys	18
4.2	General meaning of touch gestures	18
4.3	Virtual keyboard	19
4.4	Safety checks, symbols, messages	19
4.4.1	<i>Terminal voltage monitor</i>	19
4.4.2	<i>Measurement actions and messages</i>	20
4.4.3	<i>Battery indication</i>	22
4.5	Instrument main menu	22
4.6	General Settings menu	23
4.6.1	<i>Settings</i>	24
4.6.2	<i>Bluetooth initialization</i>	25
4.6.3	<i>Initial Settings</i>	25
4.6.4	<i>About</i>	26
4.6.5	<i>User accounts</i>	26
4.6.6	<i>Connectivity</i>	31
4.7	Instrument profiles	31
4.8	Workspace Manager	32
4.8.1	<i>Workspaces and Export</i>	32
5	Memory Organizer	34

5.1	Operations in Memory Organizer	34
5.1.1	Operations on Workspace	34
5.1.2	Operations on measurements	35
5.1.3	Measurement statuses	36
5.1.4	Operations on Structure objects	37
5.1.5	Searching in Memory Organizer	39
6	Single tests	41
6.1	Selection modes	41
6.1.1	Area groups	41
6.2	Single test screens	42
6.2.1	Single test start screen	42
6.2.2	Single test screen during test	43
6.2.3	Single test result screen	43
6.3	Single test (inspection) screens	44
6.3.1	Single test (inspection) start screen	45
6.3.2	Single test (Inspection) screen during test	45
6.3.3	Single test (Inspection) result screen	46
6.3.4	Help screens	47
6.4	Single test measurements	48
6.4.1	Voltage, frequency and phase sequence	48
6.4.2	R iso – Insulation resistance	50
6.4.3	R low – Resistance of earth connection and equipotential bonding	51
6.4.4	Continuity	53
6.4.5	Ring Continuity (with A 2214)	55
6.4.6	Rpe – PE conductor resistance	57
6.4.7	Testing RCDs	57
6.4.8	Z loop – Fault loop impedance and prospective fault current	60
6.4.9	Zs rcd – Fault loop impedance and prospective fault current in system with RCD 61	
6.4.10	Z line – line impedance and prospective short-circuit current	63
6.4.11	Voltage Drop	65
6.4.12	AUTO tests	67
6.4.13	Earth resistance	68
6.4.14	Diagnostic Test (EVSE)	69
6.4.15	Locator	71
6.4.16	Functional test	72
7	Auto Sequences®	73
7.1	Selection of Auto Sequences®	73
7.1.1	Searching in Auto Sequences® menu	73
7.2	Organization of an Auto Sequence®	74
7.2.1	Auto Sequence® view menu	75
7.2.2	Step by step execution of Auto Sequences®	77
7.2.3	Auto Sequence® result screen	78
7.2.4	Auto Sequence® memory screen	79
8	Communications	80

8.1	USB communication with PC.....	80
8.2	Bluetooth communication	80
9	Maintenance	82
9.1	Periodic calibration	82
9.2	Fuses	82
9.3	Battery pack insertion / replacement	83
9.4	SD card maintenance	84
9.5	Service	84
9.6	Cleaning	84
10	Technical specifications	85
10.1	R iso – Insulation resistance	85
10.2	R low – Resistance of earth connection and equipotential bonding.....	86
10.3	Continuity – Continuous resistance measurement with low current	86
10.4	Ring Continuity	87
10.5	RCD testing.....	87
10.5.1	General data	87
10.5.2	RCD t – Trip-out time.....	91
10.5.3	RCD I – Trip-out current	91
10.5.4	Uc - Contact voltage	91
10.5.5	RCD Auto.....	92
10.6	Z loop – Fault loop impedance and prospective fault current.....	92
10.7	Zs rcd – Fault loop impedance and prospective fault current in system with RCD	93
10.8	Z line – Line impedance and prospective short-circuit current	93
10.9	Voltage Drop	94
10.10	Rpe – PE conductor resistance	94
10.11	AUTO TT, AUTO TTrcd, AUTO TN, AUTO TNrcd	95
10.12	Earth – Earth resistance (3-wire measurement).....	96
10.13	Voltage, frequency, and phase rotation	96
10.13.1	Phase rotation.....	96
10.13.2	Voltage / Online terminal voltage monitor	96
10.13.3	Frequency.....	96
10.13.1	Phase rotation.....	97
10.14	Auto Sequences®	97
10.15	Diagnostic Test (EVSE) (A 1632)	97
10.16	General data.....	97
Appendix A	Commanders (A 1314-UK, A 1401)	99
A.1	 Warnings related to safety.....	99
A.2	Battery.....	99
A.3	Description of commanders	99
A.4	Operation of commanders	101
Appendix B	Locator receiver R10K (A 1191)	102
Appendix C	Structure objects in EurotestCOMBO XC.....	103

1 General description

1.1 Warnings and notes



1.1.1 Safety warnings

In order to reach high level of operator safety while carrying out various measurements using the instrument, as well as to keep the test equipment undamaged, it is necessary to consider the following general warnings:

- Read Instruction manual carefully, otherwise the use of the instrument may be dangerous for the operator, the instrument or for the equipment under test!
- Consider warning markings on the instrument (see next chapter for more information).
- If the test equipment is used in a manner not specified in this instruction manual, the protection provided by the equipment may be impaired!
- Do not use the instrument or any of the accessories if any damage is noticed!
- Regularly check the instrument and accessories for correct functioning to avoid hazard that could occur from misleading results.
- Consider all generally known precautions in order to avoid risk of electric shock while dealing with hazardous voltages!
- Always check for the presence of dangerous voltage on PE test terminal of installation by touching the TEST key on the instrument or by any other method before starting single test and Auto Sequence® measurements. Make sure that the TEST key is grounded through human body resistance without any insulated material between (gloves, shoes, insulated floors, pens,...). PE test could otherwise be impaired, and results of a single test or Auto Sequence® can mislead. Even detected dangerous voltage on PE test terminal cannot prevent running of a single test or Auto Sequence®. All such behaviour is regarded as misuse. Operator of the instrument must stop the activity immediately and eliminate the fault/connection problem before proceeding with any activity!
- Use only standard or optional test accessories supplied by your distributor!
- In case a fuse has blown follow the instructions in this manual in order to replace it! Use only fuses that are specified!
- Service, calibration or adjustment of instruments and accessories is only allowed to be carried out by a competent authorized person!
- Do not use the instrument in AC supply systems with voltages higher than 550 V a.c.

- ▶ Consider that protection category of some accessories is lower than of the instrument. Test tips and Tip commander have removable caps. If they are removed the protection falls to CAT II. Check markings on accessories!
 - cap off, 18 mm tip: CAT II up to 1000 V
 - cap on, 4 mm tip: CAT II 1000 V / CAT III 600 V / CAT IV 300 V
- ▶ The instrument comes supplied with rechargeable Li-Ion battery pack. The battery pack should only be replaced with the same type as defined on the battery compartment label or as described in this manual!
- ▶ Hazardous voltages exist inside the instrument. Disconnect all test leads and charging cable, and switch off the instrument, before removing battery /fuse compartment cover.

1.1.2 Warnings related to batteries

- ▶ Use only batteries provided by the manufacturer.
- ▶ Do not attempt to disassemble, crush or puncture the batteries in any way.
- ▶ Do not use a damaged battery.
- ▶ If a battery has leaking fluids, do not touch any fluids.
- ▶ In case of eye contact with fluid, do not rub eyes. Immediately flush eyes thoroughly with water for at least 15 minutes, lifting upper and lower lids, until no evidence of the fluid remains. Seek medical attention.

1.1.3 Warnings related to safety of measurement functions

Insulation resistance (R iso)	Insulation resistance measurement should only be performed on de-energized objects! Do not touch the test object during the measurement or before it is fully discharged! Risk of electric shock!
Continuity functions (R low, Continuity, Ring Continuity)	Continuity measurements should only be performed on de-energized objects!
RCD Contact voltage pretest	Contact voltage measurement is performed before trip-out time/current tests. If the limit U_c voltage is exceeded in the pre-test, the RCD test is aborted for safety reason.
RCD Monitoring of contact voltage during the test	Contact voltage measurement is monitored during all RCD tests. If the set limit U_c voltage is exceeded during the test the RCD test is aborted for safety reason. If U_c limit is not defined in the RCD function, the RCD test is aborted if the monitored $U_c > 25\text{ V}$ (50 V for PRCD-K).

1.1.4 Notes related to measurement functions

Insulation resistance (R iso)	<p>The measuring range is decreased if using Tip commander A 1401.</p> <p>If a voltage of higher than 30 V (AC or DC) is detected between test terminals, the measurement will not be performed.</p> <p>Load Pretest When enabled in the Settings, the Load Pretest feature performs a low-voltage impedance measurement between the test terminals before applying high voltage. If the measured impedance is below 50 kΩ, a warning message will be displayed.</p> <p>This feature helps protect sensitive electronic equipment from potential damage, caused by exposure to high test voltages.</p>
Continuity functions (R low, Continuity)	<p>If a voltage of higher than 10 V (AC or DC) is detected between test terminals, the measurement will not be performed.</p> <p>In some PRCDs (PRCD-3p and PRCD-S+), the current through protective conductor is monitored and the test current will trip-out the PRCD.</p> <p>In this case setting the parameter Current to 'ramp' may help. The slowly rising current up to 200 mA (ramp) may prevent the PRCD from tripping out.</p>
Earth	<p>If voltage between test terminals is higher than 10 V the measurement will not be performed.</p>
RCD tests (RCD t, RCD I, RCD Uc, RCD AUTO)	<p>The contact voltage pre-test or previous RCD tests may influence time delayed RCDs - it takes a certain period to recover into normal state. Therefore, there is a time delay of 30 s for S type and 5 s for G/KV before performing the selected test.</p> <p>If the RCD monitors the protective conductor too, the device will trip at $\leq 0.5 I_{\Delta N}$. To consider this, the parameter Sensitivity can be set to 'Ipe monitoring'. In this case, the actual test current will be a half of the selected one.</p>
Z loop, Zs rcd	<p>The specified accuracy of tested parameters is valid only if the mains voltage is stable during the measurement.</p> <p>Z loop test has high immunity against noise but will trip an RCD.</p> <p>(Zs rcd) For best measurement accuracy and immunity against noise I test should be set to 'Standard'.</p>

	<p>The measurement does not normally trip an RCD. However, if a leakage current from L to PE already flows or if a very sensitive RCD is installed the RCD could trip. In this case setting I test to 'Low' may help.</p> <p>(Zs rcd) If ground impedance in TT system is higher than 2 Ω, or high noise is present, it is recommended to set parameter Test frequency to '125 Hz', for better stability of test results.</p>
Z line, Voltage drop	<p>In case of measurement of ZLine-Line with the instrument test leads PE and N connected together the instrument will display a warning of dangerous PE voltage. The measurement will be performed anyway.</p> <p>The specified accuracy of tested parameters is valid only if mains voltage is stable during the measurement.</p> <p>If the Zref value is not set, or reset by Zref measurement with disconnected test leads, it is considered as 0.00 Ω.</p>
Rpe	<p>The specified accuracy of tested parameters is valid only if the mains voltage is stable during the measurement.</p> <p>The test current will trip an RCD if the parameter RCD is set to 'No'.</p> <p>To avoid tripping out the RCD the parameter RCD should be set to 'Yes'.</p>
AutoTTrcd, Auto TNrzd, Auto TN, AutoTT	See notes related to Zline, Zloop, Zs rcd, Voltage drop and Rpe single tests.
Auto Sequences®	<p>METREL assumes no responsibility for any Auto Sequence® by any means. It is the user's responsibility, to check adequacy for the purpose of use of the selected Auto Sequence®. This includes type and number of tests, sequence flow, test parameters and limits.</p> <p>See notes related to single tests in the selected Auto Sequence®.</p> <p>Compensate test leads resistance before entering Auto Sequences®.</p> <p>Zref value for Voltage drop test (ΔU) implemented in any Auto Sequence® should be set in single test function.</p>



1.1.5 Markings on the instrument



Read the Instruction manual with special care to safety operation«. The symbol requires an action!



Do not use the instrument in AC supply systems with voltages higher than 550 Va.c.!

	Mark on your equipment certifies that it meets requirements of all subjected EU regulations.
	Mark on your equipment certifies that it meets requirements of all subjected UK regulations.
	This equipment should be recycled as electronic waste.

1.1.6 Note related to measurement procedure

- In general, the procedure for measurement consists of the following steps in exact order:
 1. Select measurement function
 2. Connect test leads / accessories to the test instrument first and then to the installation under test
 3. Carry out the measurement
 4. Disconnect the device under test from the test instrument in reverse order of connection

1.1.7 General notes

- LCD screenshots in this document are informative only. Screens on the instrument may be slightly different.
- *Metrel* reserve the right to make technical modifications without notice as part of the further development of the product.

1.2 **Testing for dangerous voltages at the PE terminal**

A touch probe is integrated in the metalized Run key on instrument and commander. The presence of dangerous voltages is automatically tested when the metalized Run key is touched. If live voltage is detected, audible and visual warnings will be displayed on the LCD and some measurements are disabled.

Testing for dangerous voltages at the PE Terminal

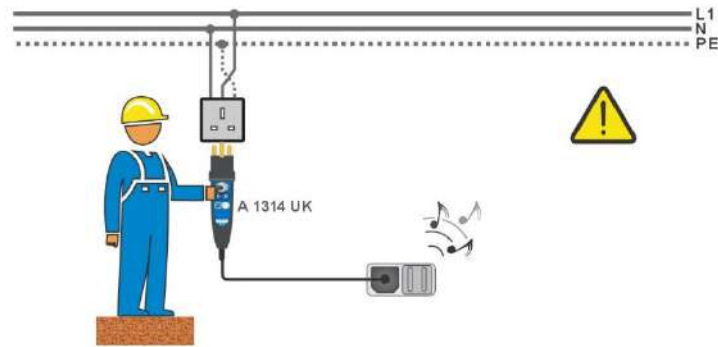

Reversed L and PE conductors (plug commander)

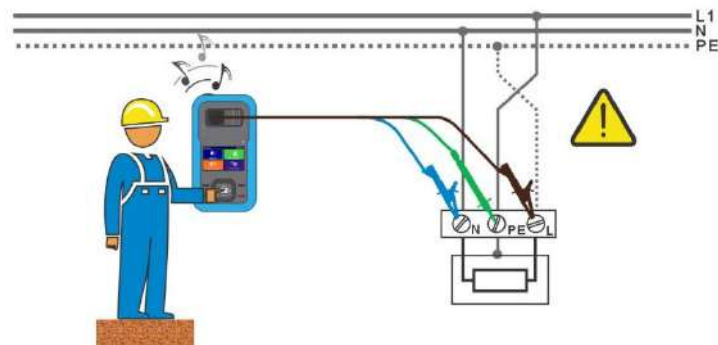

Reversed L and PE conductors (application of 3-wire test lead)

WARNINGS

- **Reversed phase and protection conductor is the most dangerous situation!**
- Presence of live voltage on installation's PE part is very dangerous as the earthed parts are accessible.
- If dangerous voltage is detected on the tested PE terminal, stop all measurements immediately and ensure the fault is corrected before proceeding with any further activity.

Notes

- PE test terminal is active in the Voltage, Rpe, RCD tests, Z loop, Zs rcd, Z auto, Z line, ΔU, AUTO TT, AUTO TT (rcd), AUTO TN, AUTO TN (rcd) tests and Auto Sequences® only!
- In IT systems, PE warnings can be ignored by enabling the 'Ignore PE Probe Warning (IT)' setting. Use this option with extreme caution.
- For accurate testing of the PE terminal, the Run key must be touched for at least 0.5 seconds.
- The human body and ground are part of the PE test current loop. Any additional insulation, such as gloves, non-conductive shoes, insulated floors, or pens, can increase resistance to a level that may compromise the test function. This must be considered!
- The function of PE touch probe may be impaired (too sensitive) at frequencies > 65 Hz

1.3 Battery and charging of Li-ion battery pack

1.3.1 Li - ion battery pack guidelines

Li - ion rechargeable battery pack requires routine maintenance and care in their use and handling. Read and follow the guidelines in this Instruction manual to safely use Li - ion battery pack and achieve the maximum battery life cycles.

Do not leave batteries unused for extended periods of time - more than 6 months (self - discharge). Rechargeable Li - ion battery pack has a limited life and will gradually lose their capacity to hold a charge. As the battery loses capacity, the length of time it will power the product decreases.

Storage:

- Charge or discharge the instruments battery pack to approximately 50% of capacity before storage.
- Charge the instrument battery pack to approximately 50% of capacity at least once every 6 months.

1.4 Standards applied

The instrument is manufactured and tested according to the following regulations, listed below.

Electromagnetic compatibility (EMC)

BS EN 61326-1	Electrical equipment for measurement, control and laboratory use - EMC requirements - Part 1: General requirements
BS EN 61326-2-2	Electrical equipment for measurement, control and laboratory use - EMC requirements - Part 2-2: Particular requirements - Test configurations, operational conditions and performance criteria for portable test, measuring and monitoring equipment used in low-voltage distribution systems

Safety (LVD)

BS EN 61010-1	Safety requirements for electrical equipment for measurement, control, and laboratory use - Part 1: General requirements
BS EN 61010-2-030	Safety requirements for electrical equipment for measurement, control and laboratory use - Part 2-030: Particular requirements for testing and measuring circuits
BS EN 61010-031	Safety requirements for electrical equipment for measurement, control and laboratory use - Part 031: Safety requirements for hand-held probe assemblies for electrical measurement and test

BS EN 61010-2-032	Safety requirements for electrical equipment for measurement, control and laboratory use – Part 2-032: Particular requirements for hand-held and hand-manipulated current sensors for electrical test and measurement
-------------------	---

Functionality

BS EN 61557	Electrical safety in low voltage distribution systems up to 1000 VAC and 1500 VDC – Equipment for testing, measuring or monitoring of protective measures Part 1: General requirements Part 2: Insulation resistance Part 3: Loop impedance Part 4: Resistance of earth connection and equipotential bonding Part 5: Resistance to earth Part 6: Residual current devices (RCDs) in TT, TN and IT systems Part 7: Phase sequence Part 10: Combined measuring equipment
-------------	--

Reference standards for electrical installations and components

BS EN 61008	Residual current operated circuit-breakers without integral overcurrent protection for household and similar uses
BS EN 61009	Residual current operated circuit-breakers with integral overcurrent protection for household and similar uses
IEC 60364-4-41	Electrical installations of buildings Part 4-41 Protection for safety – protection against electric shock
BS 7671	IEE Wiring Regulations (18th edition)
AS/NZS 3017	Electrical installations – Verification guidelines
IEC 62752	In-cable control and protection device for mode 2 charging of electric road vehicles (IC-CPD)
IEC 62955	Residual direct current detecting device (RDC-DD) to be used for mode 3 charging of electric vehicles

2 Instrument set and accessories

2.1 Basic set of the instrument

- Instrument MI 3136 EurotestCOMBO XC
- A 1857 USB C to C cable, 1m
- A 1296 3-wire test lead, 3 x 1.5 m
- Test probe, 3 pcs (A 1298 brown, A 1015 blue, A 1062 green)
- Crocodile clip, 3 pcs (A 1297 brown, A 1310 blue, A 1309 green)
- A 1003 Test cable, 1.5 m, 0.75 mm²
- A 1826 Li-ion battery pack, 7.2 V , 5200 mAh
- SW 1201 Metrel ES Manager*
- Short form instruction manual (Quick Guide)
- Calibration certificate

Note

The actual contents of the set may vary, depending on the country where purchased.
Please refer to the list of accessories provided with your instrument.

*SW 1201 Metrel ES Manager and all documentation can be downloaded free of charge from Metrel Web server (<https://www.metrel.si/en/downloads/>) or Metrel Documentation center (<https://doc.metrel.si/>).

2.2 Optional accessories

For a list of optional accessories, approved with this test instrument, visit www.metrel.si.

3 Instrument description

3.1 Front panel



Test connector options:

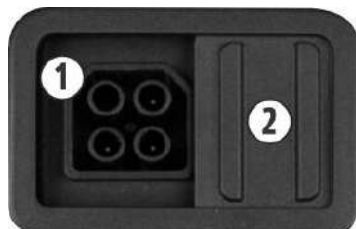

1	Test connector
2	Protection cover
3	USB C communication / charging port
4	Colour TFT display with touch screen
5	Set of keys (for details, see chapter General meaning of keys)

3.2 Bottom side

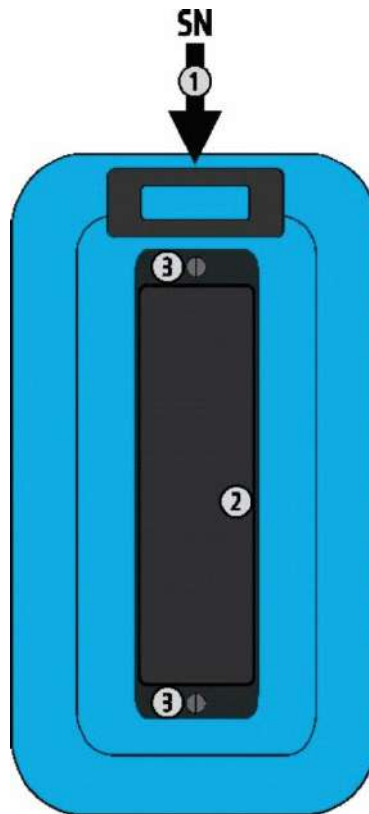

1	Serial number label
2	Battery / fuse compartment cover with information label
3	Battery / fuse compartment cover screws

3.2.1 Battery / fuse compartment

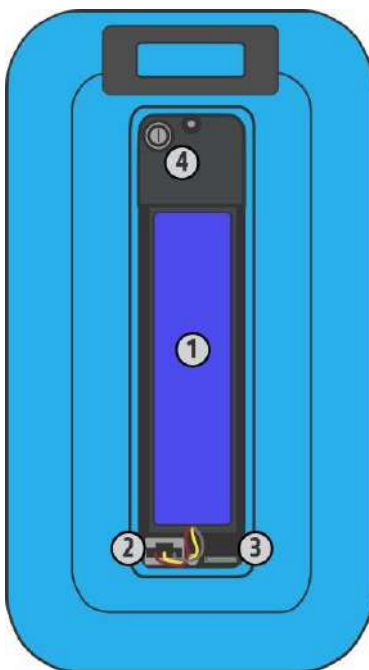

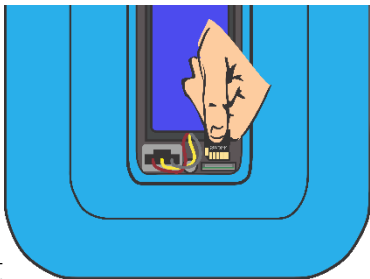





1	Li-ion battery pack
2	Battery connector
3	 <p>Micro SD card slot</p>
4	Fuse (for details, see chapter Fuses)

4 Instrument operation

The instrument can be manipulated via a keypad or touch screen.

4.1 General meaning of keys

	<p>Cursor keys are used to:</p> <ul style="list-style-type: none"> • Select appropriate option. • Left, right, up, down. • In some functions: page up, page down.
	<p>RUN key is used to:</p> <ul style="list-style-type: none"> • Confirm selected option. • Start and stop measurements. • Test PE potential.
	<p>Escape key is used to:</p> <ul style="list-style-type: none"> • Return to previous menu. • Abort measurements.
	<p>Option key is used to:</p> <ul style="list-style-type: none"> • Expand column in control panel. • Show detailed view of options.
	<p>Save key is used to:</p> <ul style="list-style-type: none"> • Store test results.
	<p>On / Off key is used to:</p> <ul style="list-style-type: none"> • Switch On / Off the instrument; • Switch Off and reset the instrument if pressed and held for 5 s.

4.2 General meaning of touch gestures

	<p>Tap (briefly touch surface with fingertip) is used to:</p> <ul style="list-style-type: none"> • Select appropriate option. • Confirm selected option. • Start and stop measurements.
---	--



Swipe (press, move, lift) up/ down is used to:

- Scroll content in same level.
- Navigate between views in same level.



Long press (touch surface with fingertip for at least 1 s) is used to:

- Select additional keys (virtual keyboard).



Tap Escape icon is used to:

- Return to previous menu.
- Abort / stop measurements.

4.3 Virtual keyboard



Notes

- If Backspace is held for 2 s, all characters will be selected.
- Set English, Greek, Russian, Hebrew character set: eng, GR, RU, HEB.

Hint

Long press on some keys opens additional keys.

4.4 Safety checks, symbols, messages

4.4.1 Terminal voltage monitor

The terminal voltage monitor displays:

- on-line voltages on the test terminals
- information about active test terminals
- information about polarity of test signals

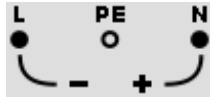
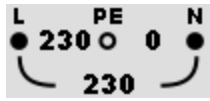

A filled marked circle indicates the active terminals for the selected test.

A non-filled circle indicates that the terminal is not used in the selected test.

(+) and (-) symbols indicate the polarity of the signal generated by the instrument during the test.

4.4.2 Measurement actions and messages



Count down timer (in seconds) within measurement.



Measurement is running, consider displayed warnings.



RCD tripped out during the measurement



Instrument is overheated. A new measurement is not allowed until the temperature decreases under the allowed limit.



High noise on mains was detected.

High interference current during earth resistance measurement.

Results may be impaired.



L and N are changed. Depending on the instrument profile and measurement, the instrument will/ will not allow to proceed with the test.



WARNING

High voltage is applied to the test terminals.

















WARNING

Dangerous voltage on the PE terminal! See chapter [Testing for dangerous voltages at the PE terminal](#) for more information.



Test leads resistance in R low / Continuity is not compensated.

	Test leads resistance in R low / Continuity is compensated.
	High resistance to earth of current test probes. Results may be impaired.
	High resistance to earth of potential test probes. Results may be impaired.
	High resistance to earth of potential and current test probes. Results may be impaired.
	Single fault condition in IT system.
	Fuse is broken.
	Test passed.
	Test failed.
	Measurement was aborted. Consider displayed warnings and messages.
	Conditions on the input terminals allow starting the measurement
	Conditions on the input terminals do not allow starting the measurement.
	Proceeds to next step of the measurement.
	Stop the measurement.
	Result(s) can be stored.
	Starts test leads compensation in Rlow / Continuity measurement. Starts Zref line impedance measurement.



Bluetooth communication active / inactive.



Wi-Fi communication active / inactive.
Wi-Fi signal strength is indicated.

Hint

For some icons more information is displayed if  on icon.

4.4.3 Battery indication

The battery indication indicates the charge condition of battery and connection of external charger.



Battery capacity indication.



Battery is full.



Low battery. Results may be impaired. Recharge the battery.



Empty battery or no battery.



Charging in progress (if power supply adapter is connected).



Charging finished.

4.5 Instrument main menu

From the instrument Main Menu four main operation menus can be selected.

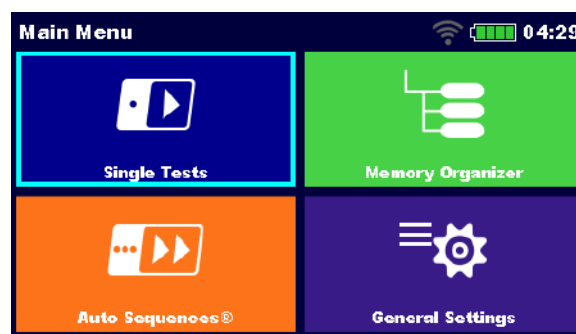

Single Tests

Menu for selecting single tests

Auto Sequences®

Menu for selecting Auto sequences

Memory Organizer	Menu for working with structured test objects and measurements
General Settings	Menu for setup of the instrument

4.6 General Settings menu

In the General Settings menu general parameters and settings of the instrument can be viewed or set.

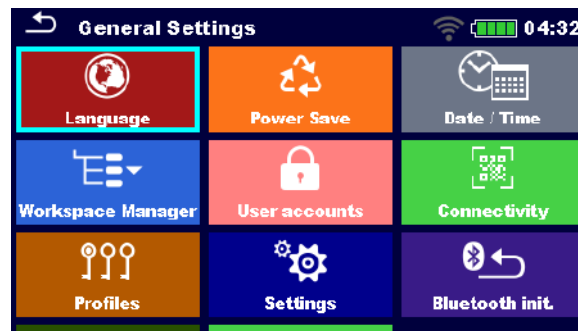

Language	Language selection
Power Save	Power saving options
Date / Time	Setting date and time
Workspace Manager	Managing project files
User accounts	Managing user accounts
Connectivity	Menu with QR code link for connection to Metrel Cloud app
Profiles	Instrument profiles (This setting is visible only if more than one profile is available.)
Settings	Setting different system and measuring parameters
Bluetooth init.	Bluetooth initialization
Initial Settings	Factory settings
About	Instrument data

4.6.1 Settings

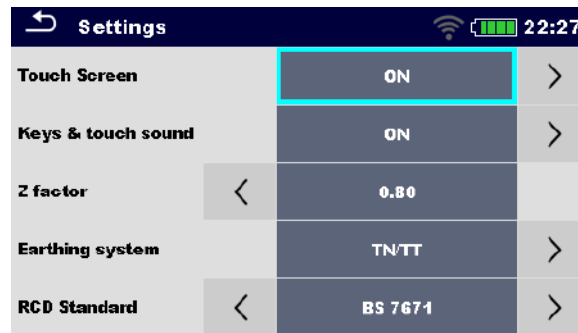

Touch screen	Set Touch screen on / off.
Keys & touch sound	Set keys touch sound on / off.
Z factor	Set Impedance scaling factor.
Earthing system	Selection of Earthing System: [TN/TT, IT] The terminal voltage monitor and measurement functions are adjusted accordingly.
RCD Standard	Used standards for RCD tests. Maximum RCD disconnection times differ in various standards. The trip-out times defined in individual standards are listed in RCD trip out time limits / test duration .
EV RCD/RCM Standards	Used standards for RCD tests for DD RCD and IC CPD RCDs.
Merge fuses	<ul style="list-style-type: none"> • Yes – Fuse type and parameters set in one function are also kept in other functions • No – Fuse parameters apply only within the specific function where they were set.
Ignore PE warning (IT)	<p>This setting applies only if IT earthing system is selected.</p> <ul style="list-style-type: none"> • Yes – measurement is allowed if voltage on PE warning is detected. • No – measurement is not allowed if voltage on PE warning is detected.
Uc pretest (IT)	<p>This setting applies only if IT earthing system is selected.</p> <ul style="list-style-type: none"> • Yes – measurement is not allowed if Uc result exceeds set limit. • No – a message is displayed if the Uc result exceeds the set limit; the operator must confirm to proceed with the selected measurement

IscMax, IscMin calculation	Enable/ disable IscMax, IscMin calculation in Z line measurement.
Load pretest	Enable/ disable load pretest in Riso. See Notes related to measurement functions for more information.
External Device	<ul style="list-style-type: none"> • None – Disable the commander's keys. In case of high EM interfering noise the operation of the commander can be irregular. • Commander – Working with commander is enabled.
Adapter Type	Configuration of the adapters. See section Adapters .
Limit Uc	Contact voltage limit [Custom, 12 V, 25 V, 50 V]

4.6.1.1 Adapters

Settings menu provide selection and configuration of Metrel measuring adapters to perform supported tests and measurements.

Adapter type	Selection of available adapters.
Port	Sets communication port of selected measuring adapter. See chapter Bluetooth communication for more details.
Bluetooth device name	After searching is finished, selection of all available Bluetooth devices is presented.

4.6.2 Bluetooth initialization

In this menu the Bluetooth module is reset.

4.6.3 Initial Settings

In this menu internal Bluetooth module will be initialized and the instrument settings, measurement parameters and limits will be set to initial (factory) values.

WARNING

Following customized settings will be lost when setting the instruments to initial settings:

- Measurement limits and parameters.
- Parameters, System settings and Devices in General settings menu.
- Opened Workspace will be deselected.
- User will be signed out.

Note

Following customized settings will stay:

- Profile settings
- Data in memory (Data in Memory organizer, Workspaces and Auto Sequences®)
- User accounts

4.6.4 About

In this menu instrument data (name, serial number, FW (firmware) and HW (hardware) version, FW profile, HD (hardware documentation) version, fuse version and date of calibration) can be viewed.

About	
Name	MI 3136 EurotestCOMBO XC
S/N	25460480
FW version	1.1.31.a8d3f0a5
FW Profile	BKAC
HW version	1
HD version	1

Note

- Info of test adapters is also displayed if they are connected.

4.6.5 User accounts

The demand to sign in can prevent from unauthorized persons to work with the instrument.

In this menu user accounts can be managed:

- Setting if signing in to work with the instrument is required or not.
- Adding and deleting new users, setting user permissions, user names and passwords.

The user accounts can be managed by the administrator.

Factory set administrator password: ADMIN

It is recommended to change factory set administrator password after first use. If the custom password is forgotten the second administrator password can be used. This password always unlocks the Account manager and is delivered with the instrument.

If a user account is set and the user is signed in the user's name will be stored in memory for each measurement.

Individual users can change their passwords.

4.6.5.1 Signing in

If signing in is demanded, the user must enter the password in order to work with the instrument.

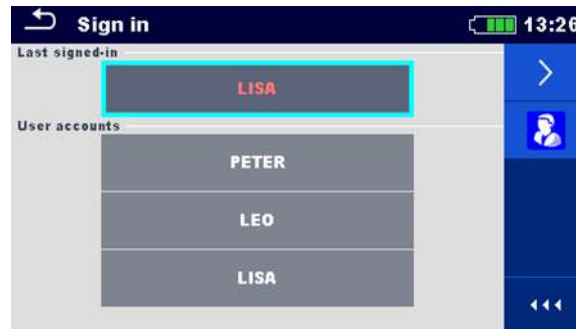

Options

User signing in

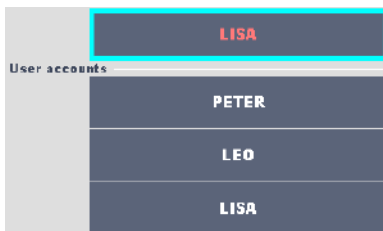

The user should be selected first. The last used user is displayed in the first row.



Goes to Password entry menu.



To sign in, the selected user password must be entered and confirmed.

The user password consists of a up to 4-digit number.

Administrator signing in



Enters Account manager menu.

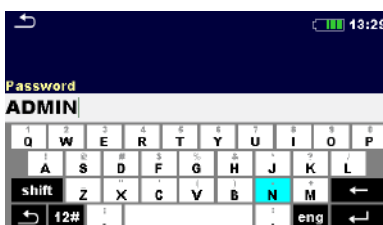

The administrator password must be entered and confirmed first.

Administrator password consists of letters and/or numbers. Letters are case sensitive.

4.6.5.2 Changing user password, signing out



Options



Signs out the set user.



Enters procedure for changing the user's password.

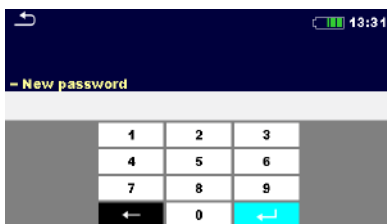

The actual password must be entered first followed by the new password.



Enters the Account manager menu.

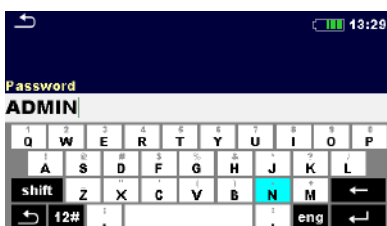

The Account manager menu is accessed by selecting Account Manager in Sign in menu or User profile menu. The administrator password must be entered and confirmed first.

The factory set default administrator password is: ADMIN

4.6.5.3 Managing accounts



Options



Field for setting if signing in is required to work with the instrument.

Field for setting if signing is required once or at each power on of the instrument.



Enters procedure for changing the administrator password.

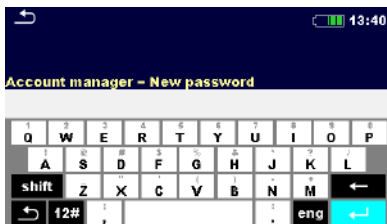

The actual password must be entered first followed by the new password.



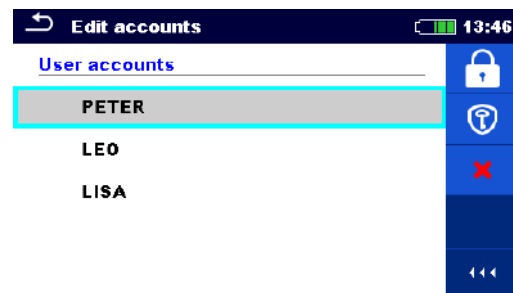
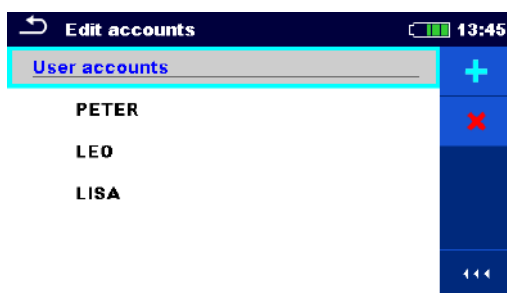

Enters menu for editing user accounts.



Options

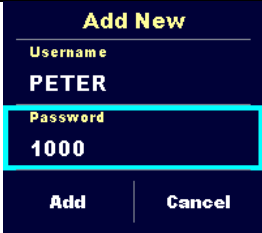

Opens the window for adding a new user account.

	<p>In the Add New window the name and initial password of the new user account are to be set. 'Add' confirms the new user account.</p>
	<p>Changes password of the selected user account.</p>
	<p>Deletes all user accounts. Deletes the selected user account.</p>

4.6.5.4 Setting Black-box password

Black-box password can be set by administrator from the Account manager menu. Set Black-box password is valid for all users. Default Black-box password is empty (disabled).

Options

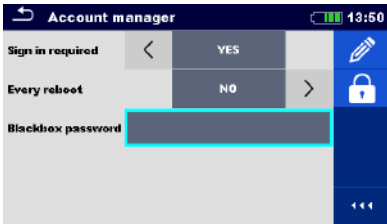
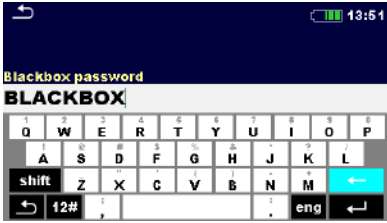
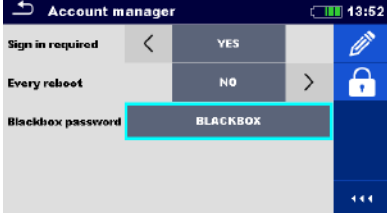
	<p>Add or edit Black-box password. Enter to modify.</p>
	<p>Keyboard for entering new Black-box password is opened. Empty string disables password. Confirm entry.</p>
	<p>Black-box password is changed.</p>

Note

- Black-box protocol is used for instrument remote operation. Contact Metrel for more information.

4.6.6 Connectivity

In this menu QR code link for connection to Metrel Cloud App is displayed. Refer to Metrel Cloud help for more information.

Note

- Metrel Cloud app is available for Android and iOS.



Google Play



App Store

4.7 Instrument profiles

The instrument uses specific system and measuring settings in regard to the scope of work or country it is used. These specific settings are stored in instrument profiles. By default, each instrument has at least one profile activated. Proper licence keys must be obtained to add more profiles to the instrument.

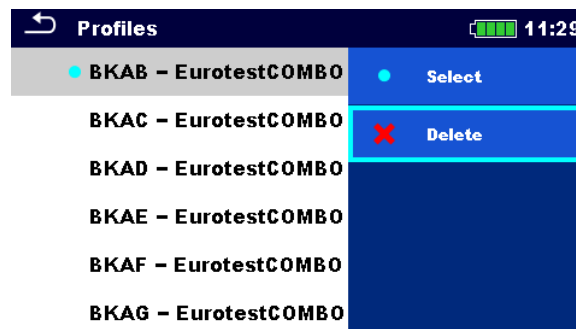

Select Select profile

Delete Delete profile

Note

- This menu is visible only if more than one profile is available.

4.8 Workspace Manager

The Workspace Manager is intended to manage with different Workspaces and Exports stored on the microSD card.

4.8.1 Workspaces and Export

The works can be organized with help of Workspaces and Exports. Both Exports and Workspaces contain all relevant data (measurements, parameters, limits, structure objects) of an individual work.

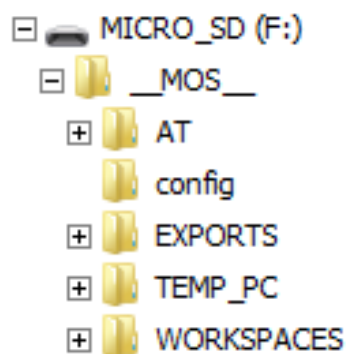

Workspaces are stored on microSD card on directory WORKSPACES, while Exports are stored on directory EXPORTS. Export files can be read by Metrel applications that run on other devices. Exports are suitable for making backups of important works or can be used for storage of works if the removable microSD card is used as a mass storage device. To work on the instrument an Export should be imported first from the list of Exports and converted to a Workspace. To be stored as Export data a Workspace should be exported first from the list of Workspaces and converted to an Export. In the Workspace manager menu Workspaces and Exports are displayed in two separated lists.



Header line (Workspaces, Exports),
Switch View

Switch between Exports and Workspaces

Header line (Workspaces), New

Add new Workspace

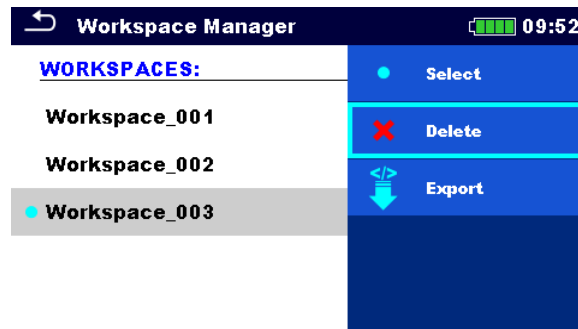

Select	Open selected Workspace in Memory Organizer
Delete	Delete selected Workspace
Export	Export selected Workspace into an Export

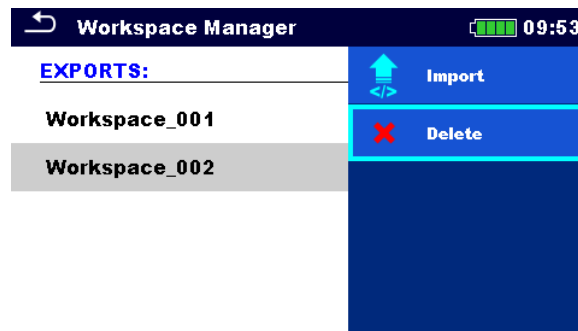

Import	Import selected Export to a Workspace
Delete	Delete selected Export

Note

- If a Workspace / Export file with the same name already exists, the name of the Imported workspace / Exported file will be changed (name_001, name_002, name_003,...).

5 Memory Organizer

Memory Organizer is an environment for storing and working with test data. The data is organized in a multilevel tree structure with Structure objects and Measurements. For a list of available structure objects see [Appendix C - Structure objects in EurotestCOMBO XC](#).

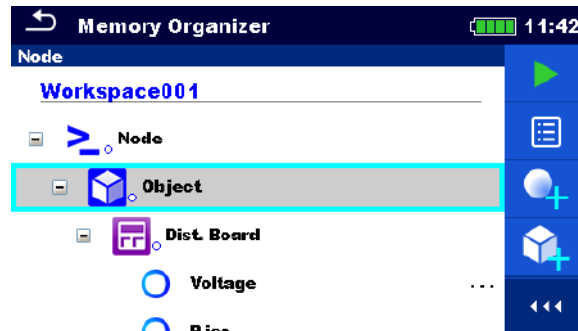

5.1 Operations in Memory Organizer

5.1.1 Operations on Workspace

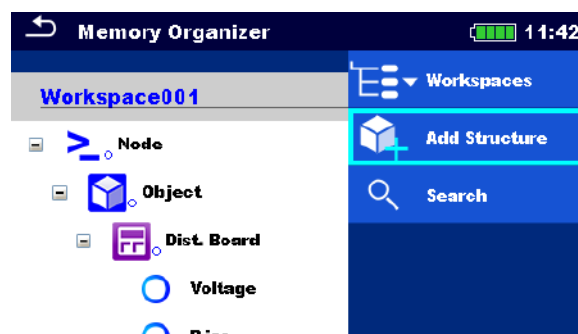

Header line (Workspace), Workspaces	Go to Workspace Manager from Memory Organizer
-------------------------------------	---

Header line (Workspace), Search	Search for structure elements
---------------------------------	-------------------------------

Node:

Node is the highest-level structure element. One Node is a must; others are optional and can be created or deleted freely.

Add a new node	Header line (Workspace), Add structure
----------------	--

5.1.2 Operations on measurements

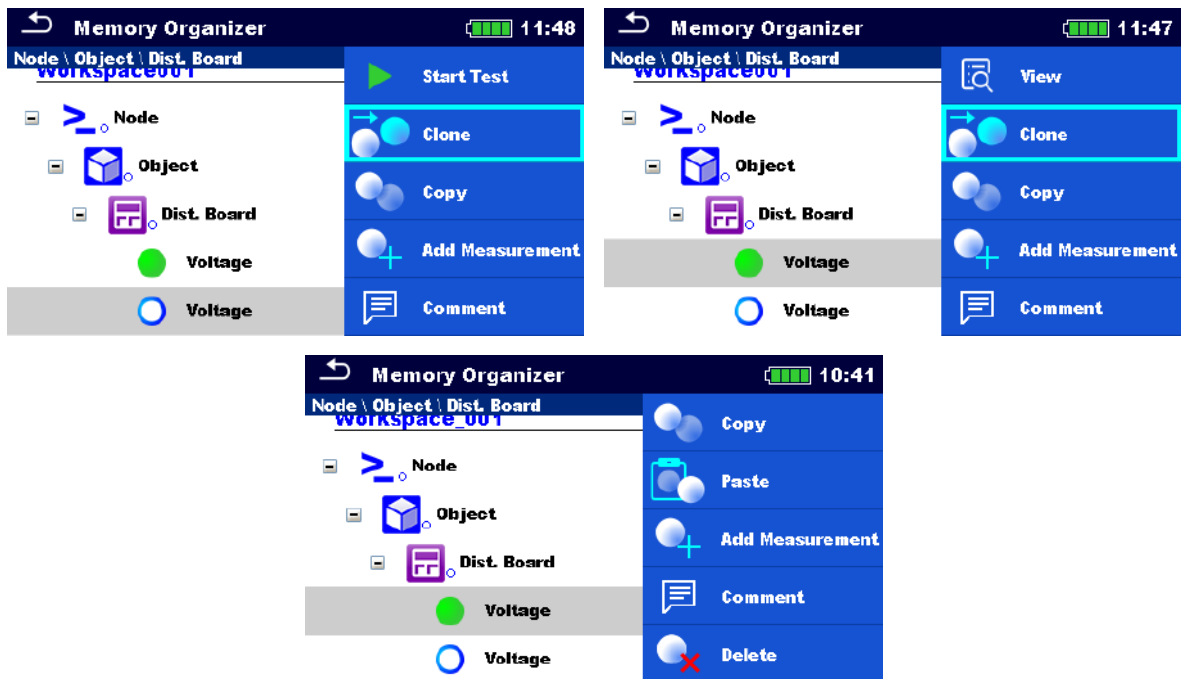

Start Test	Start a new measurement
Clone	Copy selected measurement as an empty measurement under the same Structure object
Copy, Paste	Copy a selected measurement as an empty measurement to any location in structure tree
Add Measurement	Add an empty measurement
Comment	View / add a comment to the measurement
Delete	Delete a measurement
Retest, Start Test	Run a new measurement or Auto Sequence with same settings as selected measurement

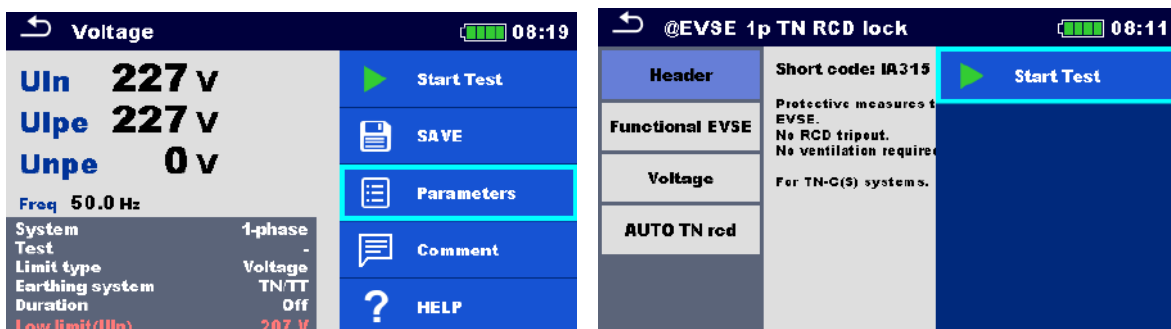

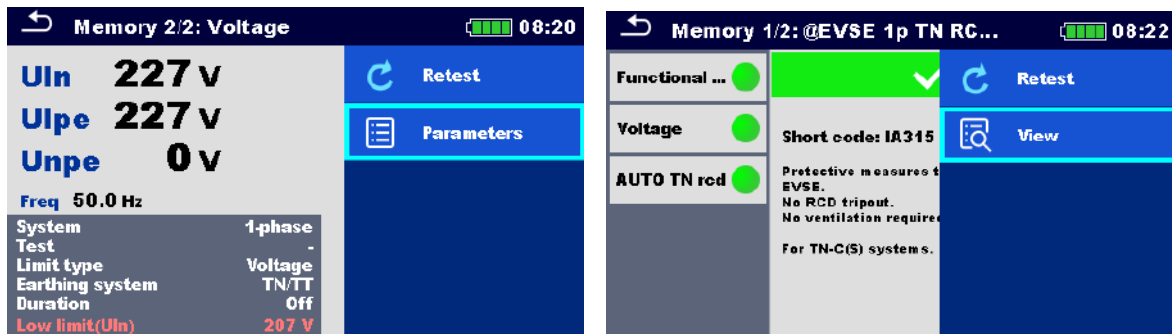

Parameters	View / edit parameters
View	Enter menu for viewing details of Single test or Auto Sequence

5.1.3 Measurement statuses

Measurement statuses indicate the status of a measurement or a group of measurements in the Memory Organizer.

Statuses of Single tests





	Passed finished single test with test results
	Failed finished single test with test results
	Finished single test with test results and no status
	Empty single test without test results

Overall statuses of Auto Sequence

or	At least one single test in the Auto Sequence passed and no single test failed
or	At least one single test in the Auto Sequence failed
or	At least one single test in the Auto Sequence was carried out and there were no other passed or failed single tests
or	Empty Auto Sequence with empty single tests

Overall status of measurements under structure elements
 Overall status of measurements under each structure element gives a fast information on tests without expanding tree menu.

Options

	There are no measurement result(s) under selected structure object. Measurements should be made.
	One or more measurement result(s) under selected structure object has failed. Not all measurements under selected structure object have been made yet.
	All measurements under selected structure object are completed but one or more measurement result(s) has failed.
	No status indication if all measurement results under each structure element / sub-element have passed or are without measurements.

5.1.4 Operations on Structure objects

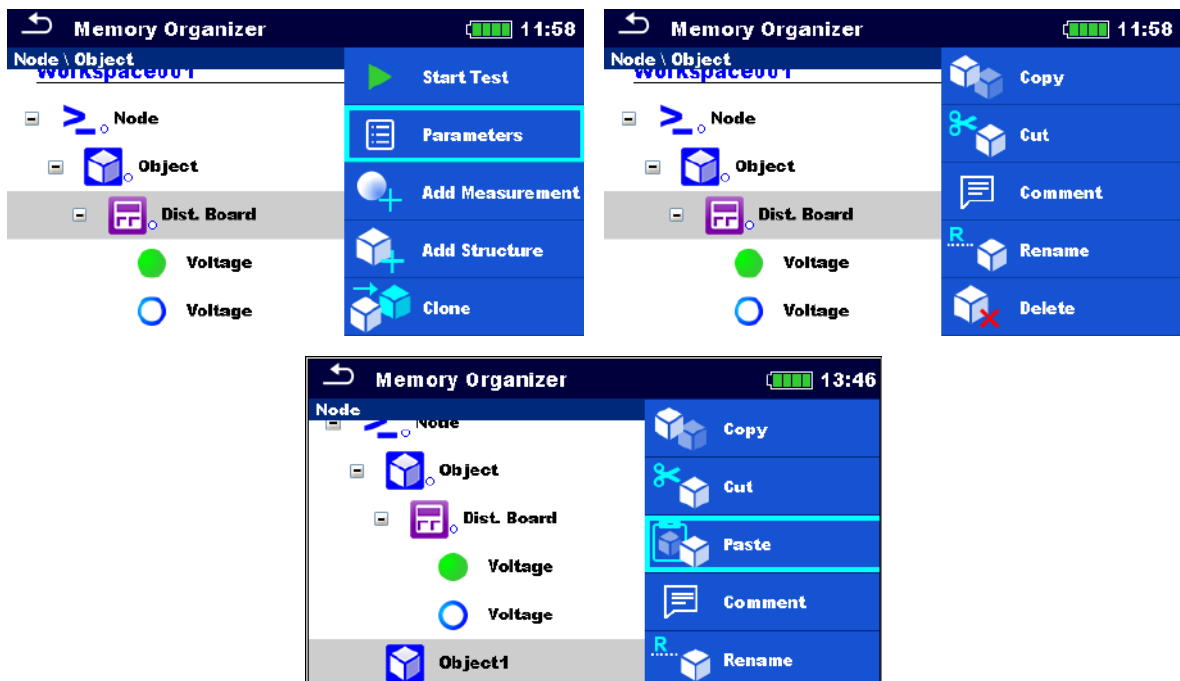

Start Test Start a new measurement (proceeds to menus for selection of measurement)

Parameters View / edit parameters

Add Measurement	Add a new empty measurement. Menu for adding new measurement will open
Add Structure	Add a new structure / sub-structure
Clone	Copy selected element as to same level in the structure tree
Copy, Paste	Copy selected element to any allowed location in structure tree
Cut, Paste	Move selected Structure with child items (sub-structures and measurements) to any allowed location in structure tree
Attachment	View link of attachment
Comment	View/edit/add a comment to the structure element
Rename	Rename the structure element
Delete	Delete the structure element

5.1.4.1 Custom lists of Structure parameter values

Some structure parameters include option to create custom lists of values for particular structure parameter. These custom values can be re-used easily, by selecting it from the custom lists, and re-typing is therefore not required.



Option



Select from a Custom list

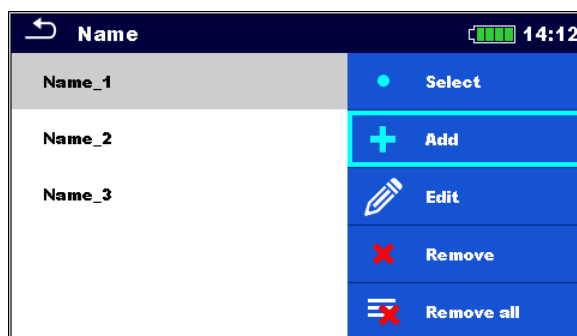
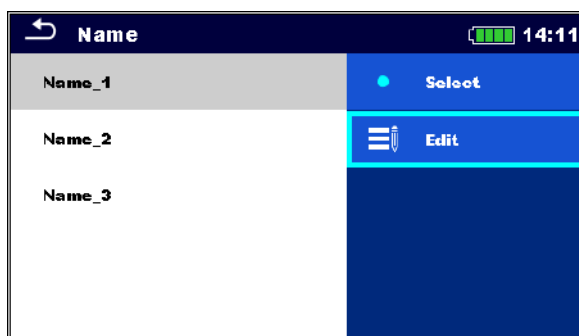

Select

Select Structure parameter value from a Custom list

Edit	Edit Custom list
Add	Add a new Structure parameter value to a Custom list
Edit	Edit selected Structure parameter value in a Custom list
Remove	Delete selected Structure parameter value from a Custom list
Remove all	Delete all Structure parameter values from a list. (Empty list)

Notes

- All Structure parameter values in a Custom list are sorted in alphabetical order.
- A Custom list contains only unique entries. Duplicates are not allowed.

5.1.5 Searching in Memory Organizer

In Memory organizer it is possible to search for different structure objects and their parameters.

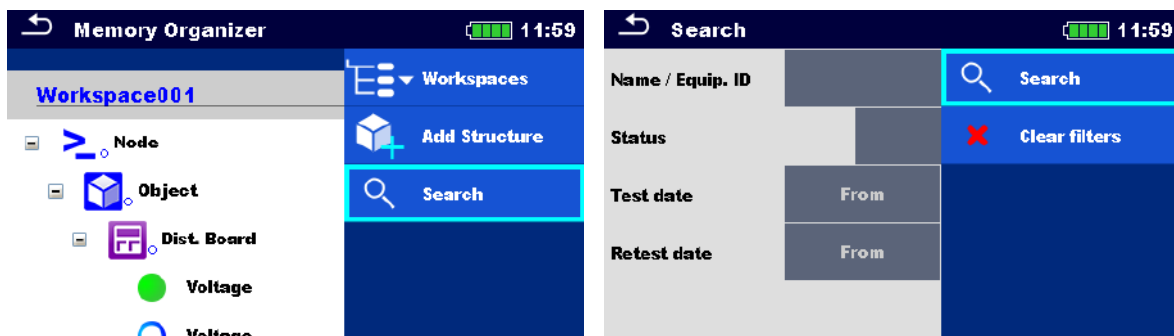

Header line (Workspace), Search	Enter Search menu
Search	Search according to parameter, status...
Clear filters	Clear set filters in Search menu

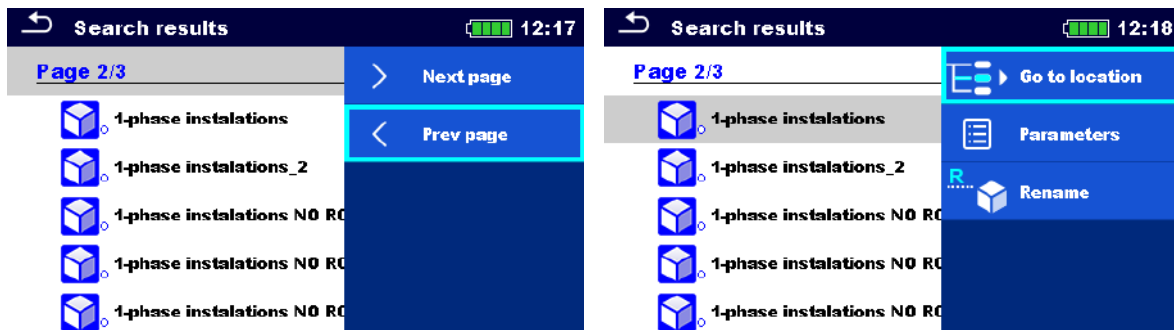

Operations on found structure objects	
Header line (Page x/y), Next Page, Previous Page	Go Page Up / Down

Go to location	Jump to selected location in Memory organizer
Parameters	View/edit parameters
Rename	Rename the found object

Note

- Searching by Equipment ID, Test date, and Retest date (if applicable) applies only to the following structure objects: Machine, EVSE and Appliance.

6 Single tests

Different modes for selecting single tests are available.

6.1 Selection modes

6.1.1 Area groups

With help of area groups, it is possible to limit the number of offered single tests, according to the field of use.

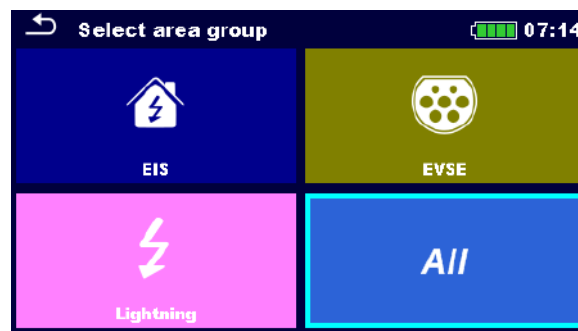

Select Area Group

Select appropriate Area group or All single tests

Groups of single tests, Last used single tests

In selected area group, two views are available.

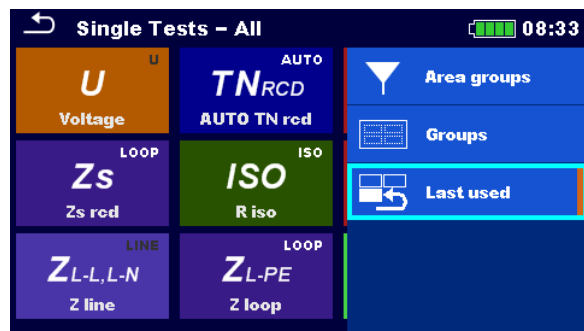

Area groups

Change area group

Groups

View groups, (sub-groups) of available measurements

Last used

View last made measurements

6.2 Single test screens

In the Single test screens main measuring results, sub-results, limits and parameters of the measurement are displayed. In addition, on-line statuses, warnings and other information are displayed.

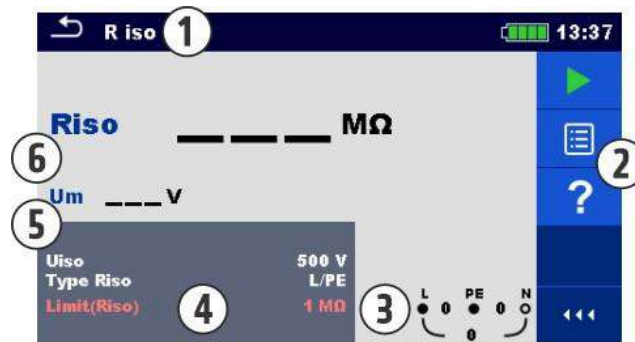

1	Name of function
2	Options
3	Statuses, infos, warnings
4	Parameters (white) and limits (red)
5	Sub-result
6	Main result

6.2.1 Single test start screen

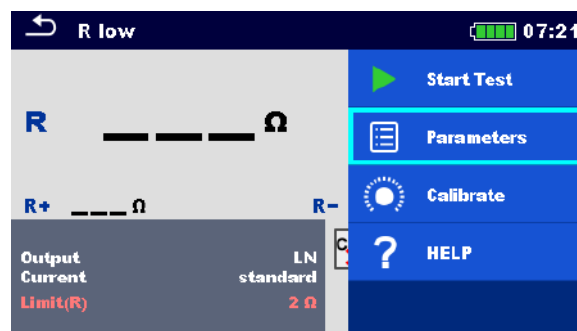

Start test	Start single test
Parameters, or tap on Parameters field	Set parameters/ limits of single test
Help	View help screens

Calibrate: other options are available, depending on the test.
See chapter [Single test measurements](#) for more information.

6.2.2 Single test screen during test

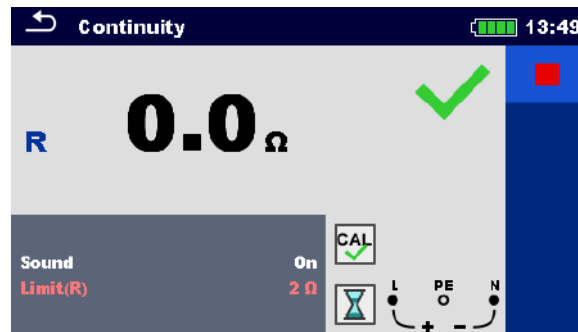

End single test



Proceed to the next step of a single test

Testing procedure (during the test)

Observe the displayed results and statuses

Check for eventual messages, warnings

6.2.3 Single test result screen

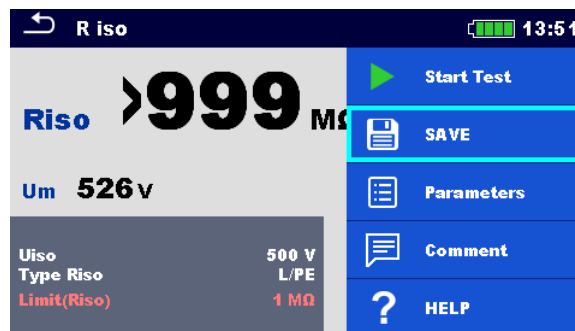

Start test Start a new single test

Save Save the result

A new measurement was started from a Structure object in the structure tree

The measurement will be saved under the selected Structure object

A new measurement was started from the Single test main menu

Saving under the last selected Structure object will be offered by default. The user can select another Structure object or create a new Structure object. By pressing the Save

	key in Memory organizer menu the measurement is saved under selected location.
An empty measurement was selected in Memory Organizer and started	The result(s) will be added to the measurement. The measurement will change its status from 'empty' to 'finished' .
An already carried out measurement was selected in Memory Organizer, viewed and then restarted	A new measurement will be saved under the selected Structure object.
Comment	Add comment to the measurement

6.3 Single test (inspection) screens

Visual and Functional inspections are a special type of single tests. Items to be visually or functionally checked are displayed. Appropriate statuses can be applied.

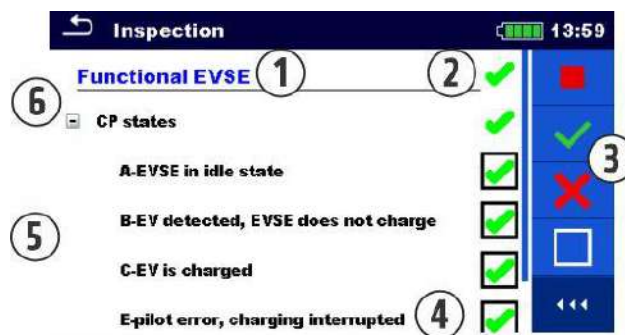

1	Selected inspection
2	Overall status
3	Options
4	Status fields
5	Child items
6	Item

6.3.1 Single test (inspection) start screen

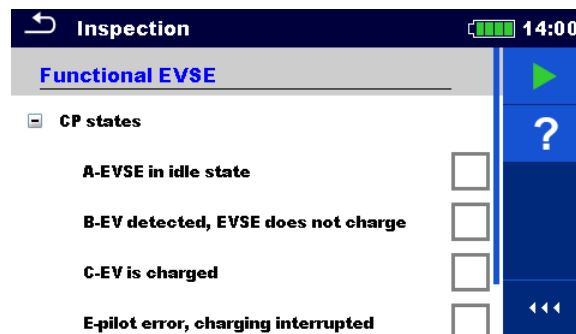

Start test

Start the inspection

Help

View help screens

6.3.2 Single test (Inspection) screen during test

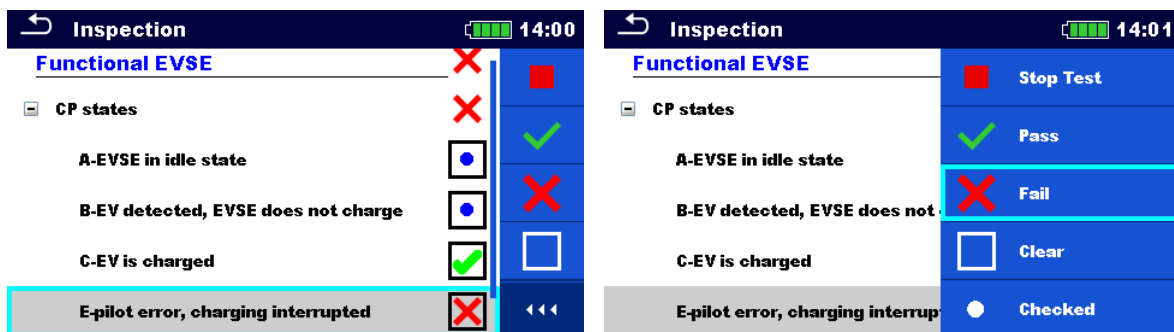

Header line (name of inspection),
apply Pass or Fail or Checked or Clear

Apply or clear the overall status to complete inspection

Select group of items,
apply Pass or Fail or Checked or Clear

Apply or clear the status of group of items

Select items,
apply Pass or Fail or Checked or Clear

Apply or clear the status of an individual item

Hint

Tap on or use  key to set status.

Rules for automatic applying of statuses

The parent items will automatically get a status on base of statuses in child items

- A fail status has highest priority. A fail status for any item will result in a fail status in all parent items and an overall fail result.
- If there is no fail status in child items the parent item will get a status only if all child items have a status.
- Pass status has priority over checked status.

The child items will automatically get a status on base of status in the parent item

All child items will get the same status as applied to the parent item.

Notes

- Inspections and even inspection items inside one inspection can have different status types. For example, some inspections don't have the 'checked' status.
- Only inspections with an overall status can be saved.

6.3.3 Single test (Inspection) result screen

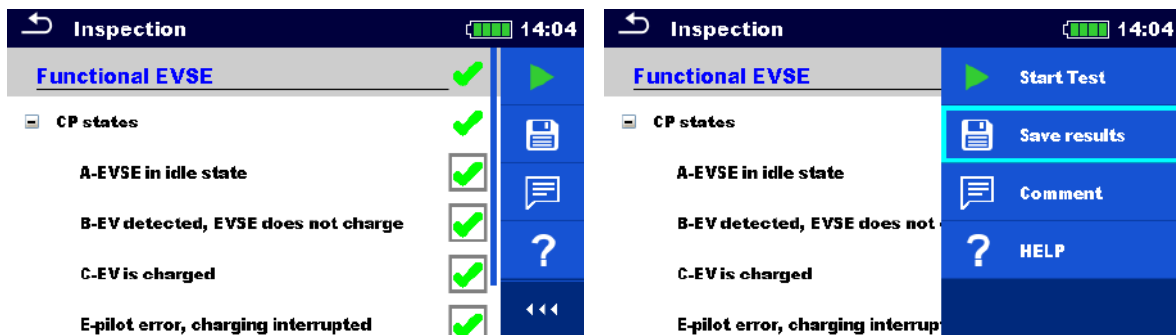

Start test	Start a new inspection
Save results	Save the result
Comment	Add comment to the inspection
Help	View help screens

A new inspection was started from a Structure object in the structure tree	The inspection will be saved under the selected Structure object.
A new inspection was started from the Single test main menu	Saving under the last selected Structure object will be offered by default. The user can select another Structure object or create a new Structure object. By pressing the Save

	key in Memory organizer menu the inspection is saved under selected location.
An empty inspection was selected in Memory Organizer and started	The result(s) will be added to the inspection. The inspection will change its status from 'empty' to 'finished'.
An already carried out inspection was selected from Memory Organizer, viewed and then restarted	A new inspection will be saved under the selected Structure object.

6.3.4 Help screens

Help screens contain diagrams for proper connection of the instrument.

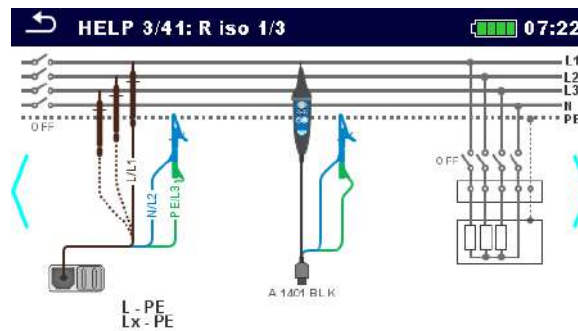

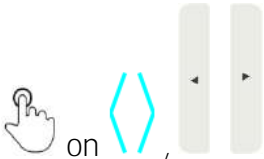
Help	Open help screen
	Go to other help screens

6.4 Single test measurements

6.4.1 Voltage, frequency and phase sequence

Test results / sub-results - for single-phase TN/TT system

UIn	Voltage between phase and neutral conductors
U _{lpe}	Voltage between phase and protective conductors
U _{npe}	Voltage between neutral and protective conductors
Freq	Frequency

Test results / sub-results - for single-phase IT system

U ₁₂	Voltage between phases L1 and L2
U _{1pe}	Voltage between phase L1 and PE
U _{2pe}	Voltage between phase L2 and PE
Freq	Frequency

Test results / sub-results - for three-phase TN/TT and IT system

U ₁₂	Voltage between phases L1 and L2
U ₁₃	Voltage between phases L1 and L3
U ₂₃	Voltage between phases L2 and L3
Freq	Frequency
Field	3-phase rotation sequence

Test parameters

System	Voltage system [-, 1-phase,3-phase]
Test	Phase to be tested [-, L1, L2, L3]
Limit type	Type of limit [Voltage, %]
Earthing system	Earthing system [TN/TT, IT]
Nominal voltage	Nominal voltage [Custom, 110 V, 115 V, 190 V, 200 V, 220 V, 230 V, 240 V, 380 V, 400 V, 415 V]
Reference field	Correct phase rotation [-, 1.2.3, 3.2.1]
Duration	Test duration [Off, Custom, 1 s, 3 s, 5 s]

Test limits - for TN/TT earthing system

Low limit UIn	Min. voltage [Off, Custom, 0 V ... 499 V]
High limit UIn	Max. voltage [Off, Custom, 0 V ... 499 V]
Low limit UIn	Min. voltage [Off, Custom, -20% ... 20%]
High limit UIn	Max. voltage [Off, Custom, -20% ... 20%]
Low limit Ulpe	Min. voltage [Off, Custom, 0 V ... 499 V]
High limit Ulpe	Max. voltage [Off, Custom, 0 V ... 499 V]
Low limit Unpe	Min. voltage [Off, Custom, 0 V ... 499 V]
High limit Unpe	Max. voltage [Off, Custom, 0 V ... 499 V]
Low limit U12	Min. voltage [Off, Custom, 0 V ... 499 V]
High limit U12	Max. voltage [Off, Custom, 0 V ... 499 V]
Low limit U13	Min. voltage [Off, Custom, 0 V ... 499 V]
High limit U13	Max. voltage [Off, Custom, 0 V ... 499 V]
Low limit U23	Min. voltage [Off, Custom, 0 V ... 499 V]
High limit U23	Max. voltage [Off, Custom, 0 V ... 499 V]
Low limit U12,U13,U23	Min. voltage [Off, Custom, -20% ... 20%]
High limit U12,U13,U23	Max. voltage [Off, Custom, -20% ... 20%]

Test limits - for IT earthing system

Low limit U12	Min. voltage [Off, Custom, 0 V ... 499 V]
High limit U12	Max. voltage [Off, Custom, 0 V ... 499 V]
Low limit U12	Min. voltage [Off, Custom, -20% ... 20%]
High limit U12	Max. voltage [Off, Custom, -20% ... 20%]
Low limit U1pe	Min. voltage [Off, Custom, 0 V ... 499 V]
High limit U1pe	Max. voltage [Off, Custom, 0 V ... 499 V]
Low limit U2pe	Min. voltage [Off, Custom, 0 V ... 499 V]
High limit U2pe	Max. voltage [Off, Custom, 0 V ... 499 V]
Low limit U13	Min. voltage [Off, Custom, 0 V ... 499 V]
High limit U13	Max. voltage [Off, Custom, 0 V ... 499 V]
Low limit U23	Min. voltage [Off, Custom, 0 V ... 499 V]
High limit U23	Max. voltage [Off, Custom, 0 V ... 499 V]
Low limit U12,U13,U23	Min. voltage [Off, Custom, -20% ... 20%]
High limit U12,U13,U23	Max. voltage [Off, Custom, -20% ... 20%]

Test circuits

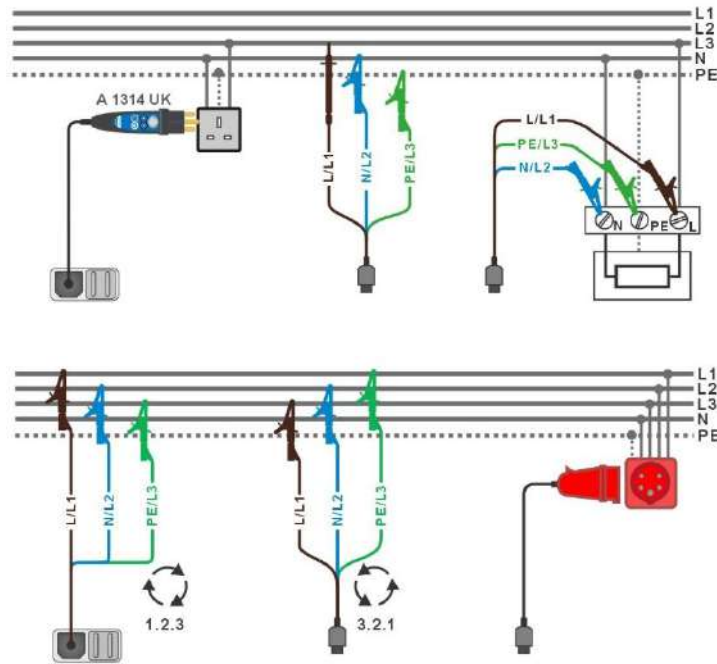

6.4.2 R iso - Insulation resistance

Test results / sub-results

Riso	Insulation resistance
Um	Test voltage

Test parameters

Uiso	Nominal test voltage: [50 V, 100 V, 250 V, 500 V, 1000 V]
Type Riso ¹⁾	Type of test: [-, L/PE, L/N, N/PE, L/L, L1/L2, L1/L3, L2/L3, L1/N, L2/N, L3/N, L1/PE, L2/PE, L3/PE]

¹⁾ Active test terminals are indicated on the voltage monitor.

Test limits

Limit (Riso)	L Limit (Riso): [Off, Custom, 10 kΩ ... 100 MΩ]
--------------	---

Test circuits

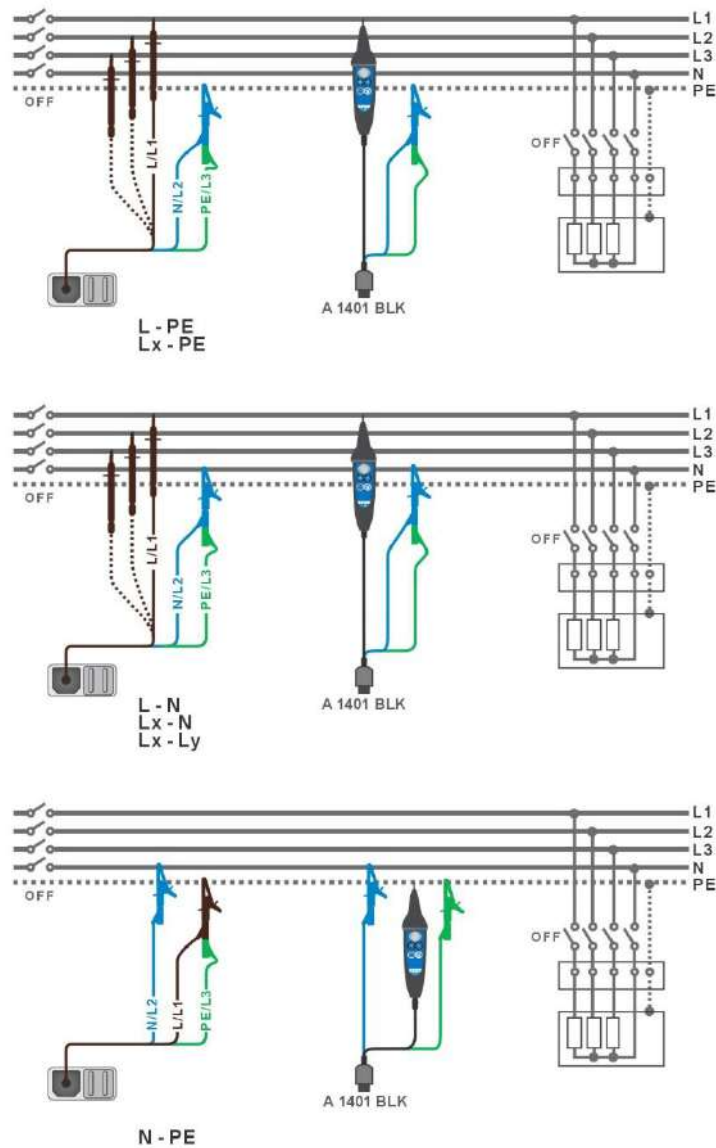

6.4.3 R low – Resistance of earth connection and equipotential bonding

Test results / sub-results

R	Resistance
R+	Result at positive test polarity
R-	Result at negative test polarity

Test parameters

Output ¹⁾	[LPE, LN, r1, m, r2, R1+R2, R2, R1+RN]
Current	[standard, ramp]

¹⁾ Active test terminals depend on Output setting. See table below.

Output	Test terminals
LN, R1+RN	L and N
LPE, r1, rn, r2, R1+R2, R2	L and PE

Test limits

Limit (R)	H Limit (R): [Off, Custom, 0.05 Ω ... 20.0 Ω]
-----------	---

Test circuits

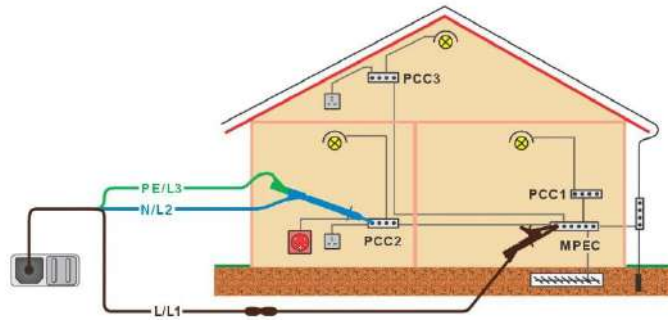

Connection of 3-wire test lead plus optional Extension lead (Output: LPE or LN)

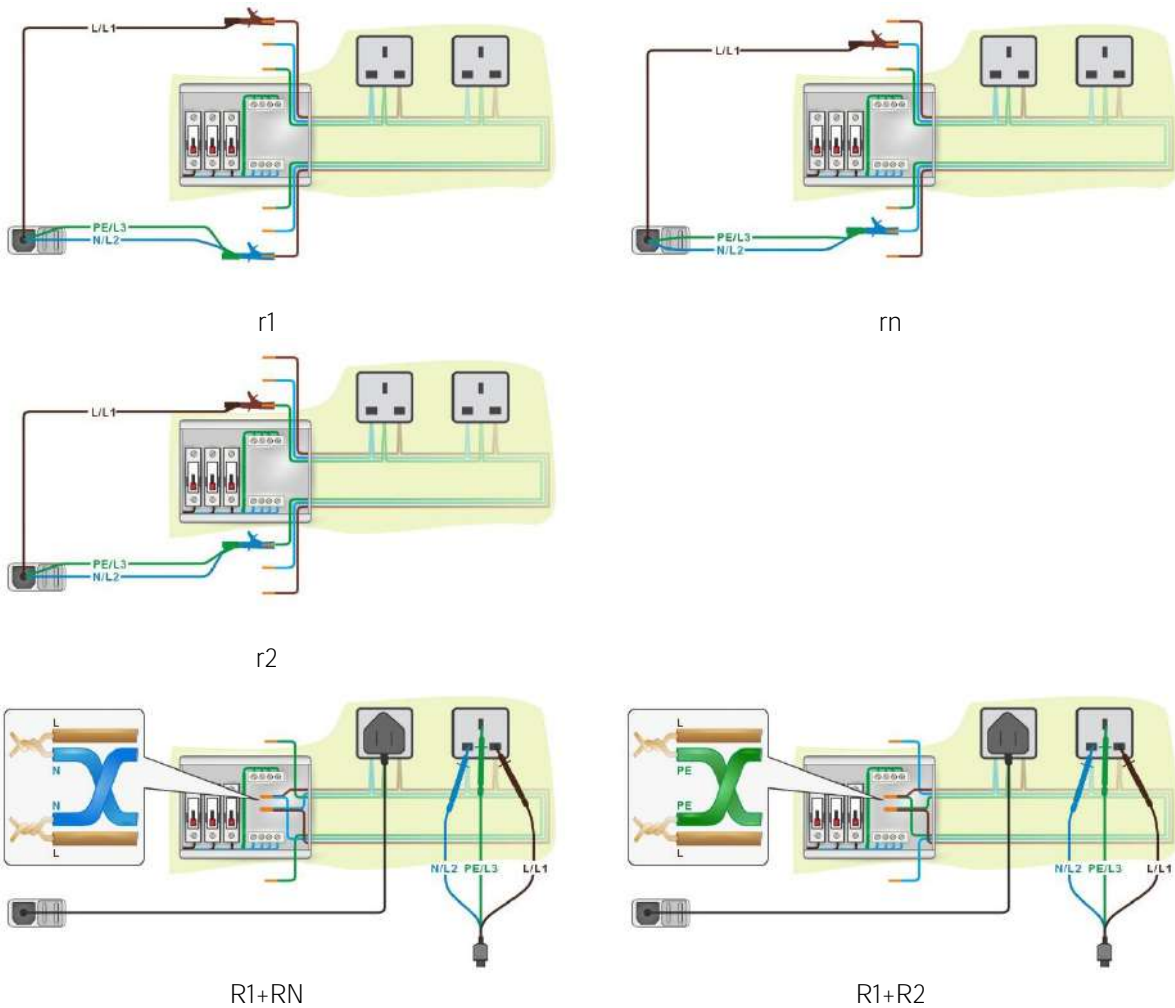

Testing r1, rn, r2, R1+RN and R1+R2 sections of the wiring in ring final circuits

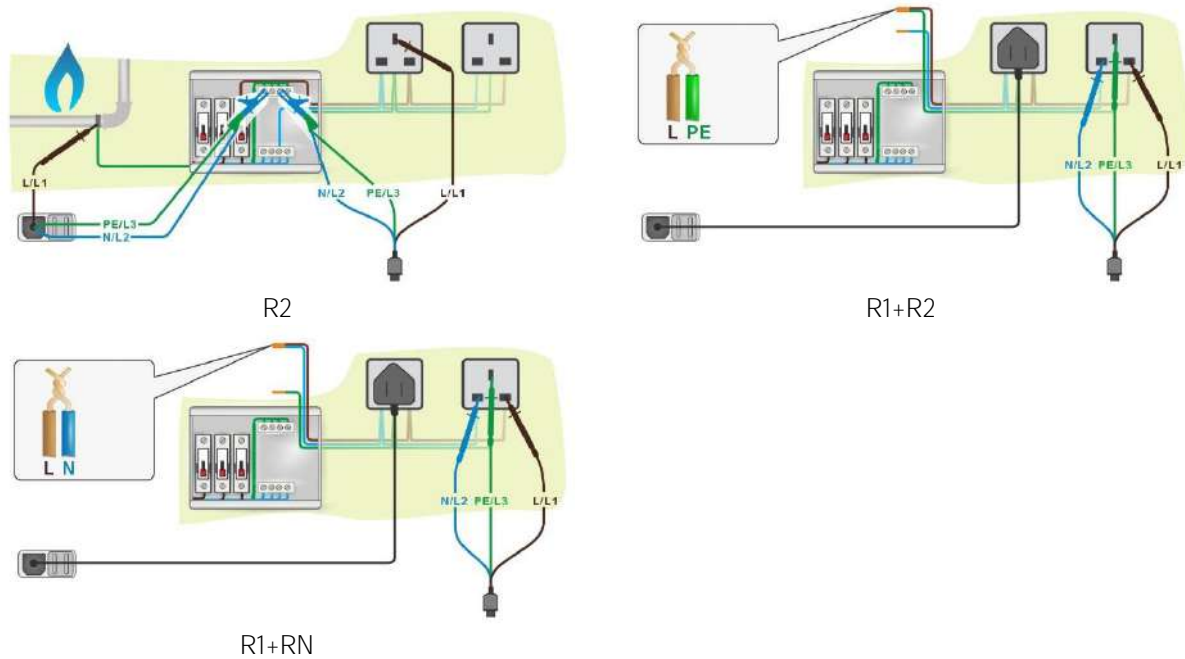

Testing R2, R1+R2 and R1+RN sections of the wiring in radial final circuits

6.4.4 Continuity

Test results / sub-results

R	Resistance
---	------------

Test parameters

Sound	[On ¹⁾ , Off]
-------	--------------------------

¹⁾ Instrument sounds if resistance is lower than the set limit value.

Test limits

Limit (R)	H Limit (R): [Off, Custom, 0.01 Ω ... 20.0 Ω]
-----------	---

Additional options

Calibrate	Compensation – see chapter Compensation of test leads resistance
-----------	--

Test circuits

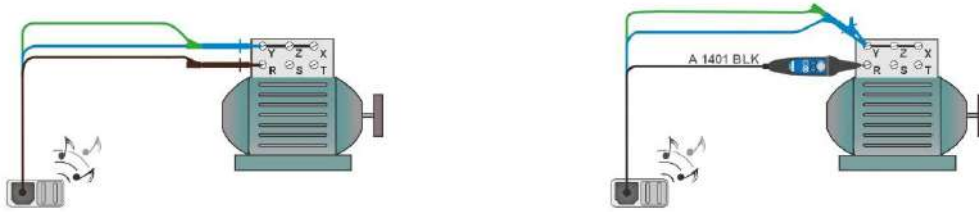

6.4.4.1 Compensation of test leads resistance

Resistance of test lead(s) and cables can be compensated. Compensation is possible in following functions:

- R low
- Continuity

Connections for compensating the resistance of test leads

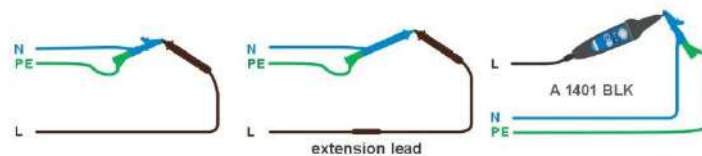

Compensation of test leads

Select single test and its parameters.

Connect test cable to the instrument and short all test leads together



Calibrate: Compensate test leads

0.00 Ω and symbol  is displayed if the compensation was carried out successfully.

Hint

- To reset compensation value, carry out compensation with open leads.

6.4.5 Ring Continuity (with A 2214)

Test results / sub-results

Step 1 - r_1 , r_2 , r_n resistances

r_1	Ring resistance of line conductors
r_n	Ring resistance of neutral conductors
r_2	Ring resistance of protective conductors



Step 2 - R_1+R_N , R_1+R_2 resistances

R_1+R_N c	Reference test value, committed and measured values
R_1+R_2 c	Reference test value, committed and measured values
$(r_1+r_n)/4$	Calculated reference value
$(r_1+r_2)/4$	Calculated reference value

Test parameters

Test	Step 1 or Step 2 selection: [(r_1, r_2, r_n) , (R_1+R_N, R_1+R_2)]
------	--

Additional options

 Calibrate	Compensate Test lead / adapter A 2214 resistance
 Commit	Commit results to values on positions R_1+R_N c and R_1+R_2 c
 Clear committed	Use Clear committed to reset committed values

Test circuits

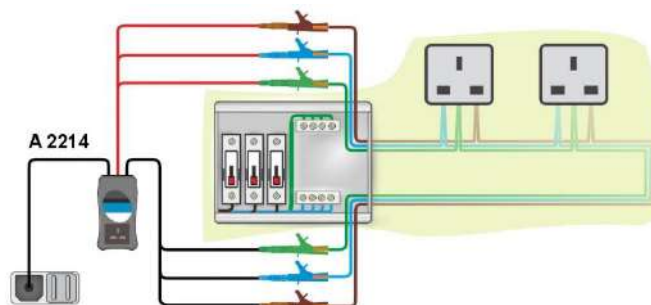

Step 1 : Measurement of resistance r_1 , r_2 and r_n with A 2214

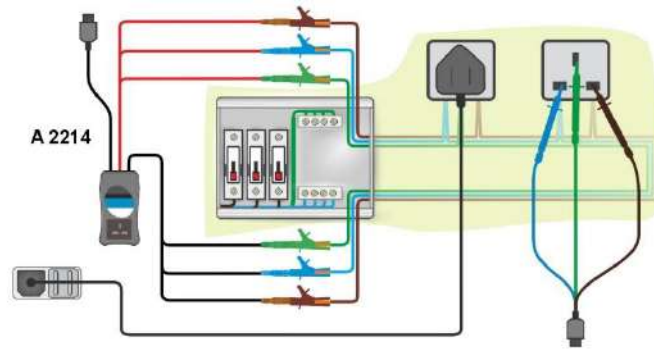

Step 2 : Testing R1+RN and R1+R2 sections of the wiring in ring final circuit with A 2214

6.4.5.1 Test lead / adapter A 2214 resistance compensation

Resistance of the Test cable / Plug cable and internal resistance of Ring Continuity Adapter (A 2214) can be compensated in Ring Continuity function.

Each setup has separate compensation.

- Step 1 – r1,r2,rN
- Step 2 – R1+RN, R1+R2

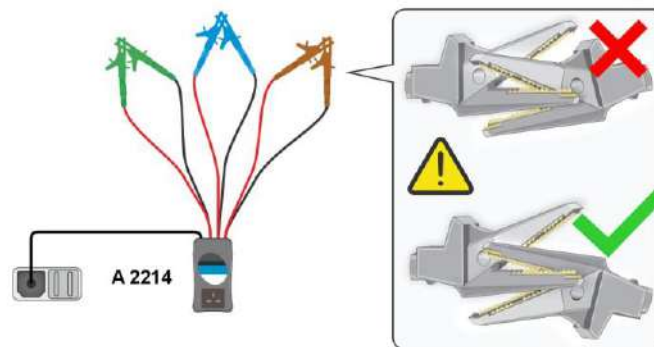

Connections for compensating the resistance of A 2214 – Step 1

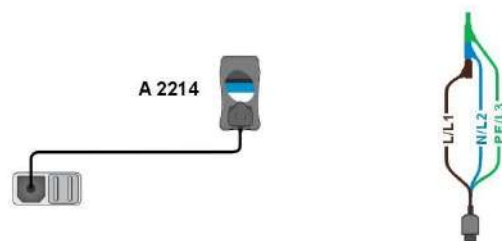

Connections for compensating the resistance of test leads – Step 2

Compensation of test leads / A 2214 internal resistance

Select Ring Continuity and Test parameter.

Connect according to the above figures.



Calibrate: Compensate test leads

0.00 Ω and symbol  is displayed if the compensation was carried out successfully.

Hint

- To reset compensation value, carry out compensation with open leads.

6.4.6 R_{pe} - PE conductor resistance

Test results / sub-results

R_{pe} PE conductor resistance

Test parameters

RCD [Yes, No]

Test limits

Limit(R_{pe}) Max. resistance [Off, Custom, 0.1 Ω ... 20.0 Ω]

Test circuit

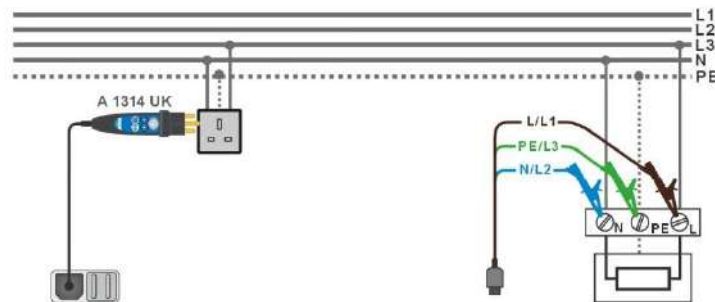

6.4.7 Testing RCDs

Following measurements for the verification of RCDs are supported:

- Contact voltage
- Trip-out time
- Trip-out current
- RCD Auto test

Note

- Displayed test parameters, test limits and test results depend on selected test, RCD type and test standard.

Test parameters

Use	Field of use [Fixed, Portable, EVSE, Other]
Name	RCD type [See table below ¹⁾]
Selectivity	Characteristic [-, S, G/KV]
Shape, Shape t, Shape I	Test current shape [Sine, Pulse, DC]
RCD I	RCD I test included [On, Off]
$I_{\Delta N}$	Rated residual current [10 mA, 15 mA, 30 mA, 100 mA, 300 mA, 500 mA, 650 mA, 1000 mA]
$I_{\Delta N} / I_{\Delta Ndc}$	Rated residual current [30 mA / 6 mA d.c., - / 6 mA d.c.]
Test	Test [-, L/PE, L1/PE, L2/PE, L3/PE]
RCD Standard	Standard for RCD
EV RCD/RCM Standard	Standard for EVSE protective device
Sensitivity	Sensitivity [standard, Ipe monitoring]
$x I_{\Delta N}$	Multiplication factor for test current [0.5, 1, 2, 5]
$x I_{\Delta N}$ d.c.	Multiplication factor for d.c. test current [0.5, 1, 10, 33.33, 50]
Phase	Starting polarity [(+), (-), (+,-)]
Earthing system	Earthing system [TN/TT, IT]

¹⁾ List of RCD names depends on field of use:

Fixed	Portable	EVSE	Other
AC	2 pole	RCD DD + Type A	MI RCD
A	3 pole	RCD DD	
B	PRCD S	IC CPD	
F	PRCD S+		
B+	PRCD S pro		
	PRCD K		

Test limits

Limit Uc	Touch voltage limit [Custom, 12 V, 25 V, 50 V]
----------	--

Test circuit

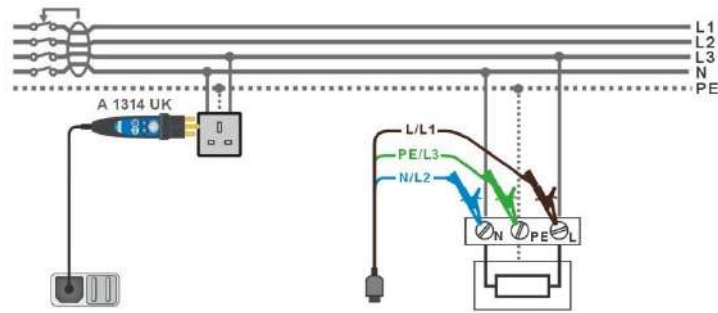

6.4.7.1 RCD U_c – Contact voltage

Test results / sub-results

U_c	Contact voltage
R_l	Fault loop resistance
R_{max}	Maximum earth fault loop resistance value according to BS 7671

6.4.7.2 RCD t – Trip-out time

Test results / sub-results

$t_{\Delta N}$	Trip-out time
U_c	Contact voltage for rated $I_{\Delta N}$

6.4.7.3 RCD I – Trip-out current

Test results / sub-results

I_{Δ}	Trip-out current
U_c	Contact voltage
$U_c I_{\Delta}$	Contact voltage at trip-out current I_{Δ} or no value if the RCD didn't trip

6.4.7.4 RCD Auto - RCD Auto test

RCD Auto Tests performs a preselected sequence of RCD tests, including trip-out time, trip-out current, and contact voltage.

Test results / sub-results

t IΔN (+multiplication factor, shape, polarity)	Trip out time @ IΔN Multiplier [x0.5 ... x10] Test current shape [sin, pul, d.c.] Test current polarity [(+), (-)]
IΔ (+shape, polarity)	Trip out current Test current shape [sin, pul, dc] Test current polarity [(+), (-)]
Uc	Contact voltage

Note

- During the Autotest the RCD may need to be reactivated one or more times.

6.4.8 Z loop - Fault loop impedance and prospective fault current

Test results / sub-results

Z	Loop impedance
Ipsc	Prospective fault current
Ulpe	Voltage L-PE
R	Resistance of loop impedance
XL	Reactance of loop impedance

Test parameters

Fuse Type ¹⁾	Selection of fuse type [Off, Custom, BS 88-2, BS 88-3, BS 3036, BS 1362, B, C, D]
Fuse I ¹⁾	Rated current of selected fuse
Fuse t ¹⁾	Maximum breaking time of selected fuse
Z factor	Z factor [Custom, 0.8, 1]
Test ²⁾	Selection of test [-, L/PE, L1/PE, L2/PE, L3/PE]

¹⁾ Refer to *Fuse tables guide* for detailed information on fuse data.

²⁾ Measurement is the same across all settings. Parameter is intended for documentation.

Test limits

Z _{lim(Z)}	Maximum loop impedance for selected fuse or custom value
---------------------	--

Test circuits

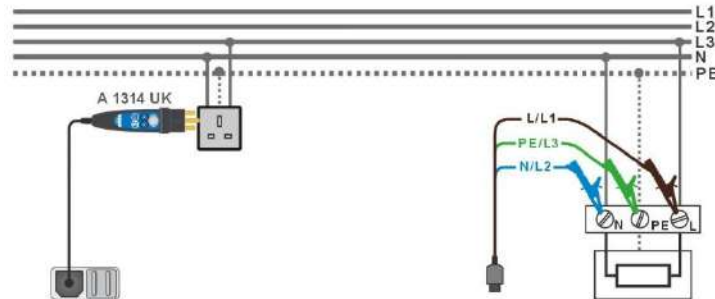

Prospective fault current I_{PSC} is calculated from measured impedance as follows:

$$I_{PSC} = \frac{U_n}{Z}$$

Loop impedance limit $Z_{lim(Z)}$ for selected fuse is calculated from the following formula:

$$Z_{Lim(Z)} = \text{Scaling_factor} \times Z_{Lim}$$

where:

Z_{Lim} Maximum loop impedance for selected fuse (according to BS 7671)
 Scaling_factor.....Impedance correction factor (Z factor); refer to chapter 4.6.1 *Settings* for more information.

U_nNominal U_{L-PE} voltage (see table below) used for calculation

U_n	U_{LPE} (measured)	I_{PSC} (calculated)
110 V	$(93 \text{ V} \leq U_{L-PE} \leq 159 \text{ V})$	Yes
230 V	$(185 \text{ V} \leq U_{L-PE} \leq 266 \text{ V})$	Yes
-	Other value	No

6.4.9 Z_s rcd – Fault loop impedance and prospective fault current in system with RCD

Z_s rcd measurement prevents trip-out of the RCD in systems with the RCD.

Test results / sub-results

Z	Loop impedance
I _{psc}	Prospective fault current
U _{lpe}	Voltage L-PE

Prospective fault current I_{PSC} is calculated from measured impedance as follows:

$$I_{PSC} = \frac{U_n}{Z}$$

Loop impedance limit $Z_{Lim(Z)}$ for selected fuse is calculated from the following formula:

$$Z_{Lim(Z)} = \text{Scaling_factor} \times Z_{Lim}$$

where:

Z_{Lim} Maximum loop impedance for selected fuse (according to BS 7671)

Scaling_factorImpedance correction factor (Z factor); refer to chapter 4.6.1 *Settings* for more information.

U_n Nominal U_{L-PE} voltage (see table below) used for calculation

U_n	U_{LPE} (measured)	I_{PSC} (calculated)
110 V	(93 V \leq U_{L-PE} \leq 159 V)	Yes
230 V	(185 V \leq U_{L-PE} \leq 266 V)	Yes
-	Other value	No

6.4.10 Z line - line impedance and prospective short-circuit current

Test results / sub-results

Z	Line impedance
Ipsc	Prospective short-circuit current
R	Resistance of line impedance
XL	Reactance of line impedance
Uln	Voltage measured between L and N test terminals
I _{max} ¹⁾	Maximal single-phase prospective short-circuit current
I _{min} ¹⁾	Minimal single-phase prospective short-circuit current
I _{max3p} ^{1), 2)}	Maximal three-phases prospective short-circuit current
I _{min3p} ^{1), 2)}	Minimal three-phases prospective short-circuit current
I _{max2p} ^{1), 2)}	Maximal two-phases prospective short-circuit current
I _{min2p} ^{1), 2)}	Minimal two-phases prospective short-circuit current

¹⁾ Parameter I_{scMax}, I_{scMin} calculation is set to Yes

²⁾ Instrument is connected to a 3-phase voltage system

Test parameters

Fuse Type ¹⁾	Selection of fuse type [Off, Custom, BS 88-2, BS 88-3, BS 3036, BS 1362, B, C, D]
Fuse I ¹⁾	Rated current of selected fuse
Fuse t ¹⁾	Maximum breaking time of selected fuse
Z factor	Z factor [Custom, 0.8, 1]
Test ²⁾	Test [-, L/N, L/L, L1/N, L2/N, L3/N, L1/L2, L1/L3, L2/L3]
Earthing system	Earthing system [TN/TT, IT]

¹⁾ Refer to *Fuse tables guide* for detailed information on fuse data.

²⁾ Measurement is the same across all settings. Parameter is intended for documentation.

Test limits

Zlim(Z)	Maximum line impedance for selected fuse or custom value
---------	--

Test circuits

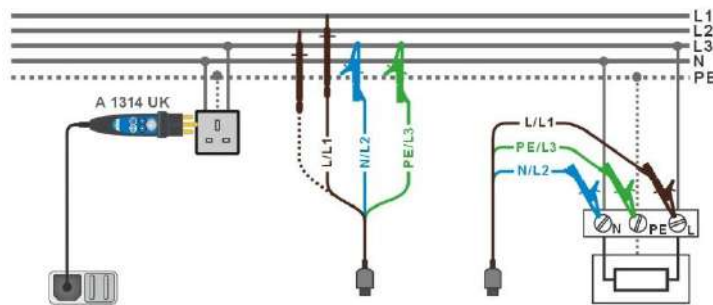

Prospective short circuit current I_{PSC} is calculated from measured impedance as follows:

$$I_{PSC} = \frac{U_n}{Z}$$

Line impedance limit $Z_{lim(Z)}$ for selected fuse is calculated from the following formula:

$$Z_{Lim(Z)} = \text{Scaling_factor} \times Z_{Lim}$$

where:

Z_{Lim} Maximum line impedance for selected fuse (according to BS 7671)

Scaling_factor.....Impedance correction factor (Z factor); refer to chapter 4.6.1 *Settings* for more information.

U_nNominal $U_{L-N(L)}$ voltage (see table below) used for calculation.

U_n	U_{LN} / U_{LL} (measured)	I_{PSC} (calculated)
110 V	$(93 \text{ V} \leq U_{L-N} \leq 134 \text{ V})$	Yes
230 V	$(185 \text{ V} \leq U_{L-N} \leq 266 \text{ V})$	Yes
400 V	$(321 \text{ V} \leq U_{L-L} \leq 485 \text{ V})$	Yes
-	Other value	No

6.4.11 Voltage Drop

The voltage drop is calculated based on the difference of line impedance at connection points (sockets) and the line impedance at the reference point (usually the impedance at the switchboard).

Test results / sub-results

ΔU	Voltage drop
I_{psc}	Prospective short-circuit current
U_{In}	Voltage L-N
Z_{ref}	Reference line impedance
Z	Line impedance

Test parameters

Fuse Type ¹⁾	Selection of fuse type [Off, Custom, BS 88-2, BS 88-3, BS 3036, BS 1362, B, C, D]
Fuse I ¹⁾	Rated current of selected fuse
Fuse t ¹⁾	Maximum breaking time of selected fuse
$I(\Delta U)$ ²⁾	Rated current for ΔU measurement (custom value)
Z factor	Z factor [Custom, 0.8, 1]
Test ³⁾	Test [-, L/N, L/L, L1/N, L2/N, L3/N, L1/L2, L1/L3, L2/L3]
Earthing system	Earthing system [TN/TT, IT]

¹⁾ Refer to *Fuse tables guide* for detailed information on fuse data.

²⁾ Applicable if Fuse type is set to Custom.

³⁾ Measurement is the same across all settings. Parameter is intended for documentation.

Test limits

Limit(ΔU)	Maximum voltage drop [Off, Custom, 3.0 % ... 9.0 %]
---------------------	---

Test circuits

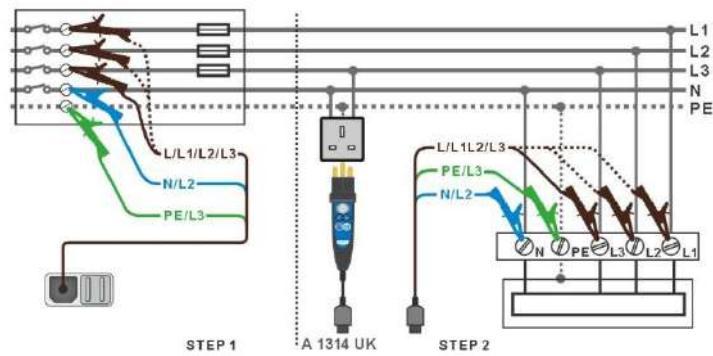

6.4.11.1 Setting Zref

1. Select Voltage Drop
2. Connect test leads / accessories to the test instrument first and then to the installation's reference point
3. Select  Zref and carry out the measurement.
4. Measured value will be stored as Zref.

Hint

- To reset compensation value, carry out compensation with open leads.

Voltage drop is calculated as follows:

$$\Delta U[\%] = \frac{(Z - Z_{REF}) \cdot I_N}{U_N} \cdot 100$$

where:

ΔU	Calculated Voltage drop
Zref	Impedance at reference point (at origin)
Z	Impedance at test point
U_n	Nominal voltage used for calculation
I_n	Rated current of selected fuse (Fuse I) or custom value I (ΔU)

U_n	U_{LN} / U_{LL} (measured)	I_{PSC} (calculated)
110 V	$(93 \text{ V} \leq U_{L-N} \leq 134 \text{ V})$	Yes
230 V	$(185 \text{ V} \leq U_{L-N} \leq 266 \text{ V})$	Yes
400 V	$(321 \text{ V} \leq U_{L-L} \leq 485 \text{ V})$	Yes
-	Other value	No

6.4.12 AUTO tests

AUTO tests combine measurements of Zline, Zloop, Zs(RCD), Voltage drop and Rpe in a fast and efficient manner.

- Auto TT is intended for testing TT systems protected by a fuse.
- Auto TTrcd is intended for testing TT systems with RCD protection.
- Auto TN is intended for testing TN systems protected by a fuse.
- Auto TNrcd is intended for testing TN systems with fuse protection supplemented by RCD protection.

Note

- Displayed test parameters, test limits and test results depend on selected test, RCD and test standard.

Test results / sub-results

UIn	Voltage between phase and neutral conductors
ΔU	Voltage drop
Z (LN)	Line impedance
Z (LPE)	Loop impedance
Zref	Reference line impedance
Ipsc (LN)	Prospective short-circuit current
Ipsc (LPE)	Prospective fault current
Rpe ¹⁾	Continuity of protective conductor
Uc ¹⁾	Contact voltage

¹⁾ where applicable

Test parameters

Name	RCD name [AC, A, B, F, B+, RCD-DD + Type A]
Selectivity	Characteristic [-, G/K, S]
I Δ N	Rated RCD residual current sensitivity [10 mA, 15 mA, 30 mA, 100 mA, 300 mA, 500 mA, 650 mA, 1000 mA]
Fuse type ¹⁾	Selection of fuse type [Off, Custom, BS 88-2, BS 88-3, BS 3036, BS 1362, B, C, D]
Fuse I ¹⁾	Rated current of selected fuse
Fuse t ¹⁾	Maximum breaking time of selected fuse
I (ΔU) ²⁾	Rated current for ΔU measurement (custom value)

Isc factor	Isc factor [Custom, 0.8, 1]
I test	Test current [Standard, Low]
Test Frequency	Frequency of test current [Low, 125 Hz]
Rpe	Rpe [On, Off]

¹⁾ Refer to [Fuse tables guide](#) for detailed information on fuse data.

²⁾ Applicable if Fuse type is set to Custom.

Test limits

Limit(ΔU)	Maximum voltage drop [Off, Custom, 3.0 % ... 9.0 %]
Zlim(Z(LPE), Z(LN))	Maximum loop / line impedance for selected fuse or custom value
Limit Uc	Conventional touch voltage limit [Custom, 12 V, 25 V, 50 V]
Limit Rpe	Max. resistance [Off, Custom, 0.05 Ω ... 20.0 Ω]

Test circuit

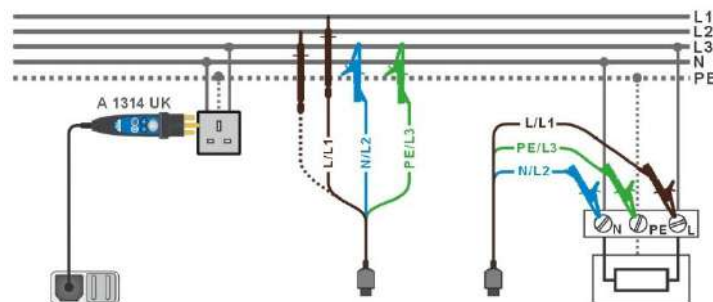

6.4.13 Earth resistance

Test results / sub-results

Re	Earth resistance
Rc	Resistance of H (current) probe
Rp	Resistance of S (potential) probe

Test limits

Limit(Re)	Maximum resistance [Off, Custom, 1 Ω ... 5 k Ω]
-----------	--

Test circuit

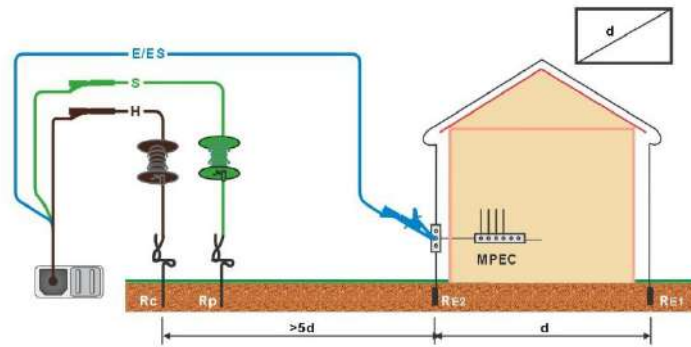

6.4.14 Diagnostic Test (EVSE)

Diagnostic Test (EVSE) should be performed with adapter A 1632 eMobility Analyser.

Test results / sub-results

CP+	Maximal value of CP (control pilot) signal
CP-	Minimal value of CP (control pilot) signal
Duty C.	Duty cycle of CP (control pilot) signal
Freq	Frequency of CP (control pilot) signal
levse	Charging current available by charging cable / EVSE
U1N	Voltage UL1-N on the output of charging cable / EVSE
U2N	Voltage UL2-N on the output of charging cable / EVSE
U3N	Voltage UL3-N on the output of charging cable / EVSE
Field	1.2.3 – correct connection – CW rotation sequence 3.2.1 – invalid connection – CCW rotation sequence
toff	Disconnection time of charging cable / EVSE
State	System state

Test parameters

Test	[EV simulator, Monitor, Errors] <i>EV simulator:</i> - Simulation of electrical vehicle. <i>Monitor:</i> - Monitoring of EVSE - EV interconnection and signalling. <i>Errors:</i> - Simulation of CP errors.
Toff	Simulated CP errors [C->E1, C->E2, C->E3, D->E1, D->E2, D->E3]
Simulator CP	CP (control pilot) state setting [nc, A, B, C, D]

Simulator PP	PP (proximity pilot) state setting [nc, 13 A, 20 A, 32 A, 63 A, 80 A]
Duration	Duration [Off, 2 s ... 180 s]
Control	Analyser control [Manual (A 1632), Remote (Bluetooth)]

Test circuits



Diagnostic test - Connection to EVSE

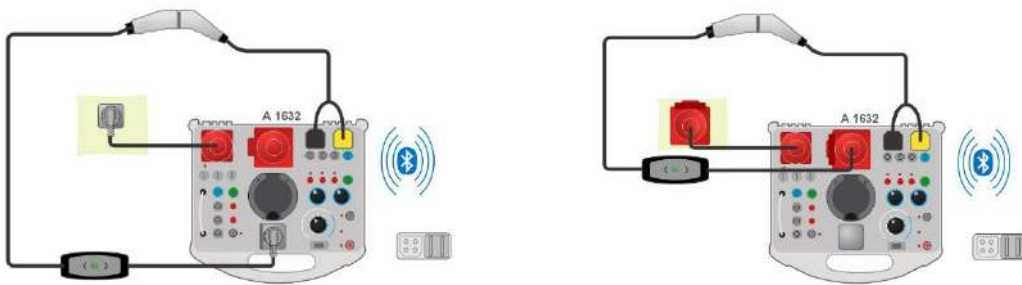

Connection to Mode 2 charging cable

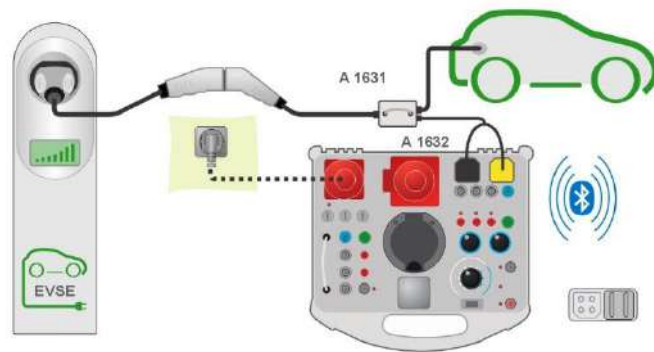

Connection to EVSE or charging cable via A1631

Note

- Refer to [A 1632 eMobility Analyser Instruction manual](#) for more information.

6.4.15 Locator

This function is intended for tracing mains installation, like:

- ▶ Tracing lines,
- ▶ Finding shorts, breaks in lines,
- ▶ Detecting fuses.

The instrument generates test signals that can be traced with the handheld tracer receiver R10K. See [Appendix B - Locator receiver R10K](#) for additional information.

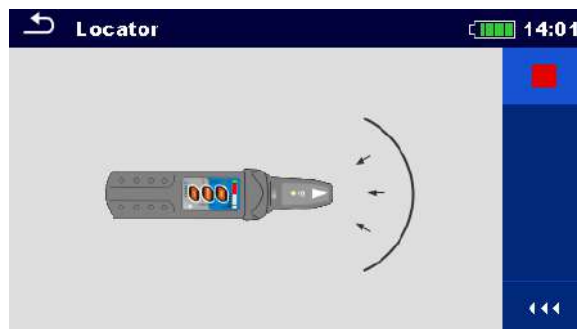

Locator active

Typical applications for tracing electrical installation

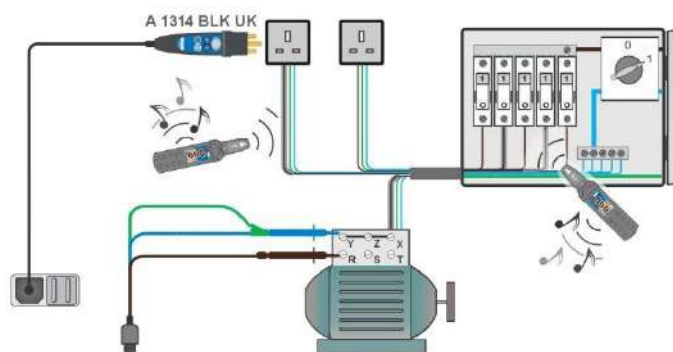

Tracing wires under walls and in cabinets

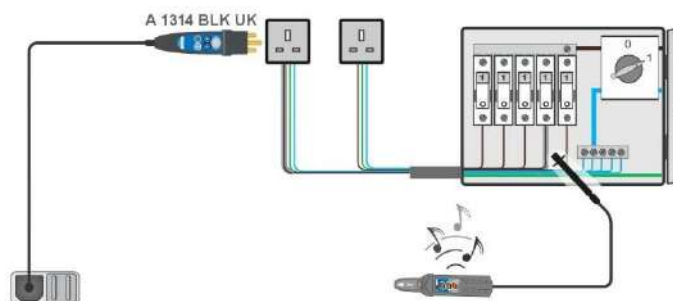

Locating individual fuses

6.4.16 Functional test

Test results / sub-results

Pass, Fail, Checked

Test circuit

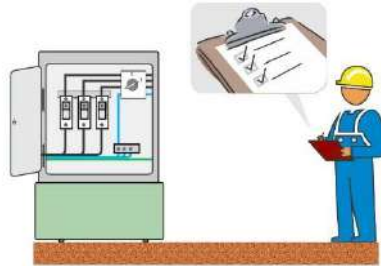

7 Auto Sequences®

Pre-programmed sequences of measurements can be carried out in Auto Sequences® menu. The results of an Auto Sequence® can be stored in the memory together with all related information.

7.1 Selection of Auto Sequences®



Options

	Auto Sequence®	The original Auto Sequence®
	Auto Sequence®	A shortcut to the original Auto Sequence®
View	View Auto Sequence	
Start Test	Start Auto Sequence	

Note

- The content of preprogramed Auto Sequences® depends on the selected instrument profile.

7.1.1 Searching in Auto Sequences® menu

In Auto Sequences® menu it is possible to search for Auto Sequences® on base of their Name or Short code.

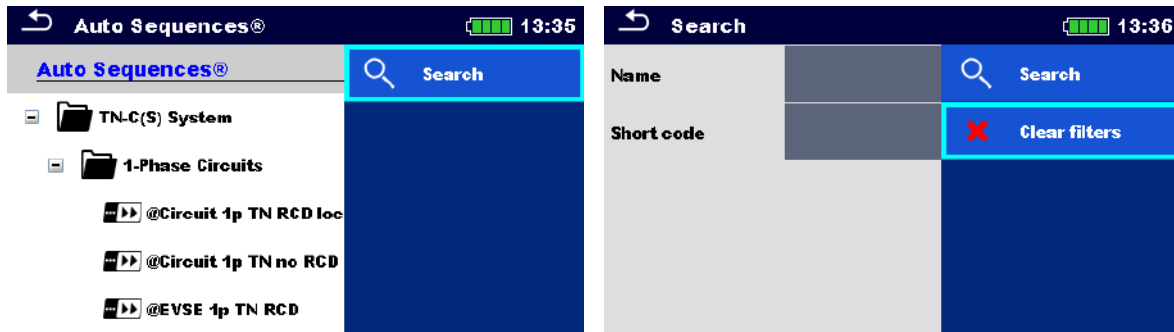

Searching of Auto Sequences

Search for Auto Sequence	Header line (Auto Sequence list), Search, set filters (Name or Short code)
Clear filters	Clear filters

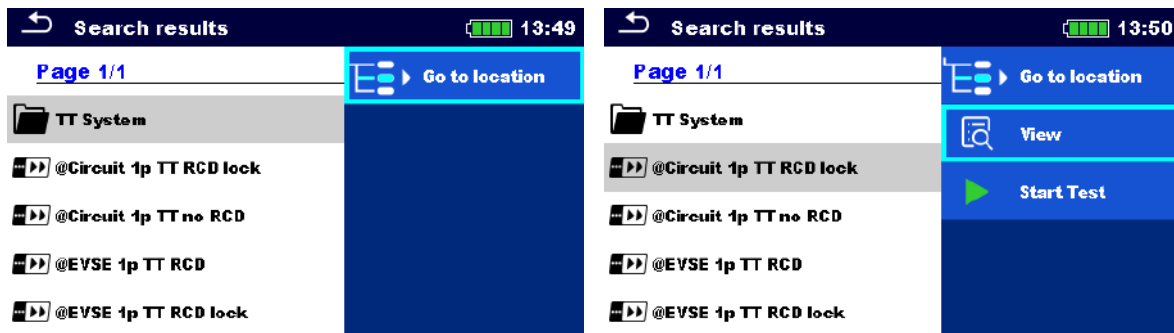

Operations on found Auto Sequences

Page x/y, Next Page, Previous Page	To jump Page Up/Down
Go to location	Go to location in Auto Sequences® menu
View	View Auto Sequence details
Start Test	Start Auto Sequence

Note

- Search result page consists of up to 50 results.

7.2 Organization of an Auto Sequence®

An Auto Sequence® measurement procedure is divided into three phases:

- Before starting the first test, the Auto Sequence® view menu is shown (unless it was started directly from the Main Auto Sequences® menu). Parameters and limits of individual measurements can be set in this menu.
- During the execution phase of an Auto Sequence®, pre-programmed single tests are carried out.

- After the test sequence is finished the Auto Sequence® result menu is shown. Details of individual tests can be viewed and the results can be saved to Memory organizer.

7.2.1 Auto Sequence® view menu

In the Auto Sequence® view menu, the header and the single tests of selected Auto Sequence® are displayed. The header contains Name, Short code and description of the Auto Sequence®. Before starting the Auto Sequence®, test parameters / limits of individual measurements can be changed.

Note

- Once fuse and RCD parameters are changed in active Auto Sequence®, the new settings are distributed through all single tests within active Auto Sequence® and stored for next use of same Auto Sequence®.

7.2.1.1 Auto Sequence® view menu (Header is selected)

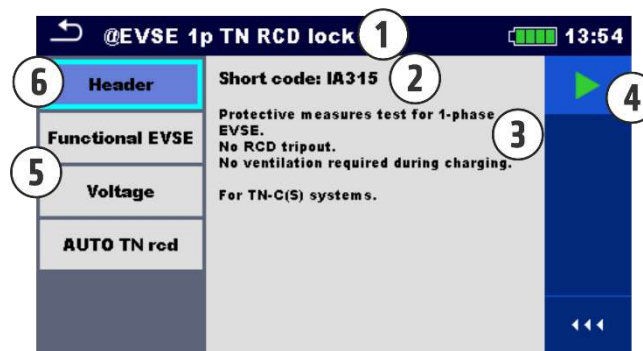

Header is selected

1	Auto Sequence name
2	Short code
3	Description
4	Options
5	Single tests
6	Header

Start Test	Start of Auto Sequence
------------	------------------------

7.2.1.2 Auto Sequence® view menu (measurement is selected)

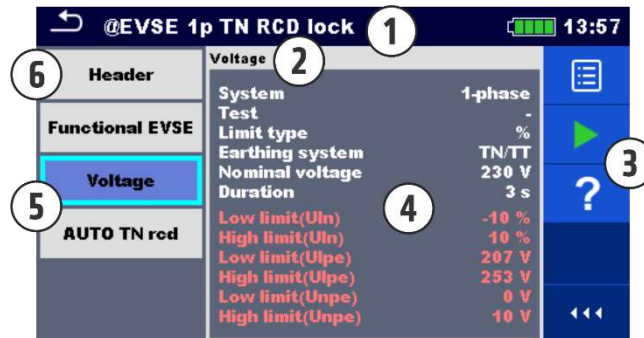

Single test is selected

1	Auto Sequence name
2	Name of selected single test
3	Options
4	Parameters / limits of selected single test
5	Single tests
6	Header
Parameters	View/edit parameters
Start Test	Start of Auto Sequence®
Help	View help screens

Additional option:

Calibrate	Compensation of test leads resistance
-----------	---------------------------------------

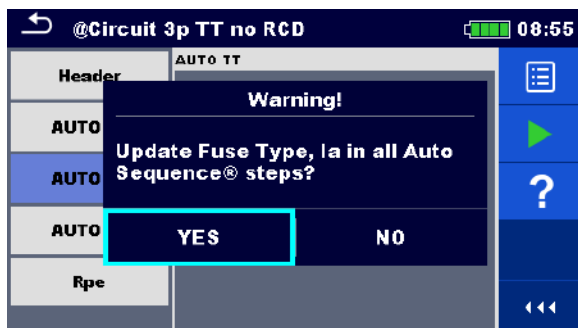

User must decide whether the changes in global parameter(s) apply to all single tests within the selected Auto Sequence® containing the modified parameter(s), or only for the edited one.

7.2.1.3 Indication of Loops

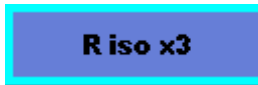

The attached 'x3' at the end of single test name indicates that a loop of single tests is programmed. This means that the marked single test will be carried out as many times as the number behind the 'x' indicates. It is possible to exit the loop before, at the end of each individual measurement.

7.2.2 Step by step execution of Auto Sequences®

While the Auto Sequence® is running it is controlled by pre-programmed flow commands.

Examples of actions controlled by flow commands

Pauses during the Auto Sequence (texts, warnings, pictures)

Buzzer Pass / Fail sound after the tests

Pre-set data off appliances

Expert mode for Inspections

Skip non-safety notifications

For the actual list and description of flow commands see [Metrel ES Manager software help file](#).

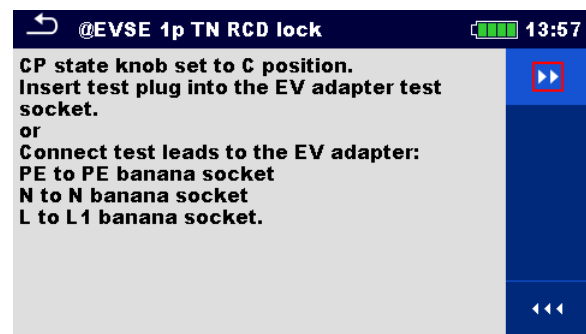
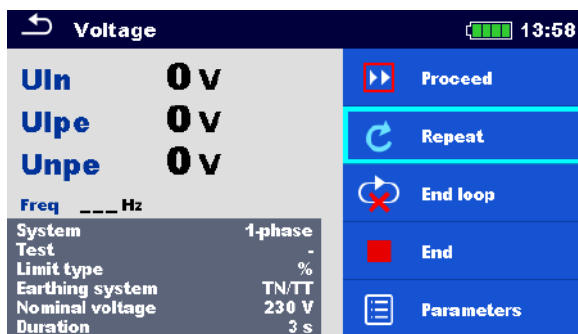

The offered options in the control panel depend on the selected single test, its result and the programmed test flow.

Proceed	Proceeds to the next step in the test sequence.
Repeat	Repeat the measurement.
End loop	Exit the loop of single tests and proceeds to the next step.
End	End the Auto Sequence® and go to result screen.
Parameters	View parameters/limits of single test.
Comment	Add comment

7.2.3 Auto Sequence® result screen

After the Auto Sequence® is finished the Auto Sequence® result screen is displayed.

At the left side of the display the single tests and their statuses in the Auto Sequence® are shown.

In the middle of the display the header of the Auto Sequence® with Short code and description of the Auto Sequence® is displayed. At the top the overall Auto Sequence result status is displayed. For more information see chapter [Measurement statuses](#).

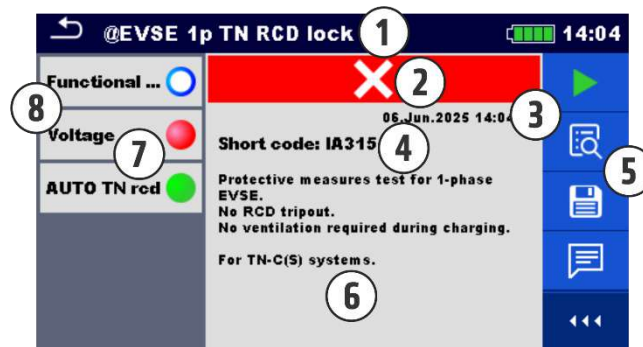

1	Auto Sequence name
2	Overall status
3	Test date and time
4	Short code
5	Options
6	Description
7	Status of single test
8	Single tests

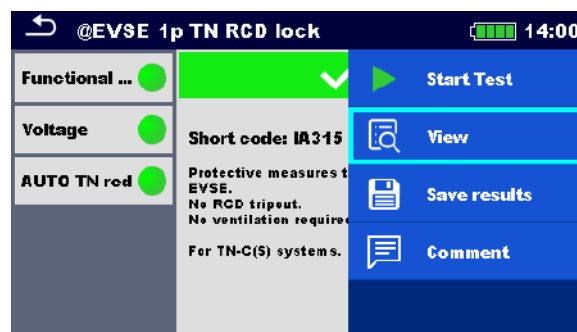

Start Test	Start a new Auto Sequence
View	View results of individual measurements.
Comment	Add comment to Auto Sequence

Tap on Single test	Viewing details of individual single tests, add comment on individual single test
Save results	Save the Auto Sequence results
A new Auto Sequence was selected and started from a Structure object in the structure tree	The Auto Sequence result will be saved under the selected Structure object
A new Auto Sequence was started from the Auto Sequence main menu	Saving under the last selected Structure object will be offered by default. The user can select another Structure object or create a new Structure object. By pressing Save in Memory organizer menu the Auto Sequence result is saved under selected location.
An empty measurement was selected in structure tree and started	The result(s) will be added to the Auto Sequence. The Auto Sequence will change its overall status from 'empty' to 'finished' .
An already carried out Auto Sequence was selected in structure tree, viewed and then restarted	A new Auto Sequence result will be saved under the selected Structure object.

7.2.4 Auto Sequence® memory screen

In Auto Sequence® memory screen details of the Auto Sequence® results can be viewed and a new Auto Sequence® can be restarted.

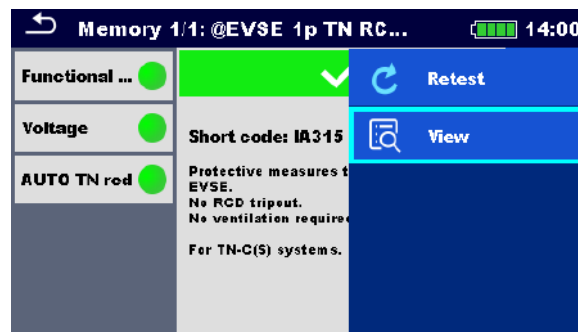

Retest	Retest the Auto Sequence®. Enters menu for a new Auto Sequence®.
View	Enters menu for viewing details of the Auto Sequence®.

8 Communications

The instrument can communicate with the Metrel ES Manager PC software. There are two communication interfaces available on the instrument: USB and Bluetooth. Instrument can also **communicate to external devices (Android devices, ...)**.

8.1 USB communication with PC

The instrument automatically selects the communication mode according to detected interface. USB interface has priority.

How to establish an USB link:

- USB communication: connect a PC USB port to the instrument USB connector using the USB interface cable.
- Switch on the PC and the instrument.
- Run the Metrel ES Manager software.
- Select communication port (COM port for USB communication is identified as **“Measurement Instrument USB VCom Port”**).
- The instrument is prepared to communicate with the PC.

8.2 Bluetooth communication

The internal Bluetooth module enables easy communication via Bluetooth with PC, Android devices and adapters.

How to configure a Bluetooth link between instrument and an Android device

-
- Switch on the instrument.
 - Some Android applications automatically carry out the setup of a Bluetooth connection. It is preferred to use this option if it exists. This option is supported by Metrel's Android applications.
If this option is not supported by the selected Android application, then configure a **Bluetooth link via Android device's Bluetooth configuration tool. Usually, no code for pairing the devices is needed.**
 - The instrument and Android device are ready to communicate.
-

Notes

- Sometimes there will be a demand from the Android device to enter the code. Enter **code '1234' to correctly configure the Bluetooth link.**
- The name of correctly configured Bluetooth device must consist of the instrument type plus serial number, e.g. *MI 3136-12240429I*. If the Bluetooth module got another name, the configuration must be repeated.
- In case of serious troubles with the Bluetooth communication it is possible to reinitialize the internal Bluetooth module. The initialization is carried out during the

Initial settings procedure. In case of a successful initialization "INITIALIZING... OK!" is displayed at the end of the procedure. See chapter [Bluetooth initialization](#).

- Metrel android application aMESM is available for download from Google play store:



How to configure a Bluetooth link between the instrument and adapter

1. Adapter: switch it ON and select BT mode, if not already automatically selected.
2. EurotestCOMBO XC: Open General Settings / Settings menu and navigate to the Adapters section.
3. Adapter type: select adapter by using left / right arrows or tap on the field and select it from the list of adapters
4. Port: Bluetooth; Proceed with pairing procedure
5. Bluetooth device name: select field and instrument start searching for Bluetooth devices; when finished, list of available devices is presented on the screen.
6. Select Adapter name from the list: pairing procedure is finished.

When test supported by the adapter is selected on EurotestCOMBO XC, active BT communication is indicated with sign  on the right-top of the screen.

Notes

- Pairing between same Metrel adapter and same EurotestCOMBO XC is necessary only when adapter is first time used.
- If communication is not established when supported test is selected, adapter is probably switched OFF or Bluetooth link is out of range.

9 Maintenance

Unauthorized persons are not allowed to open the EurotestCOMBO XC instrument. There are no user replaceable components inside the instrument, except the battery and a fuse under back cover.



9.1 Periodic calibration

It is essential that all measuring instruments are regularly calibrated in order for the technical specification listed in this manual to be guaranteed. We recommend an annual calibration.

9.2 Fuses

There is one fuse in the battery / fuse compartment:

Fuse: M 315 mA / 250 V / (20 × 5) mm / 35 A: intended for protection of Continuity test circuit

For position of a fuse see figure in chapter [Battery / fuse compartment](#).

WARNINGS

- Switch off the instrument and disconnect all test accessories and charger from the instrument, before replacing the fuses.
- Replace blown fuses with the same type as defined in this document.

9.3 Battery pack insertion / replacement

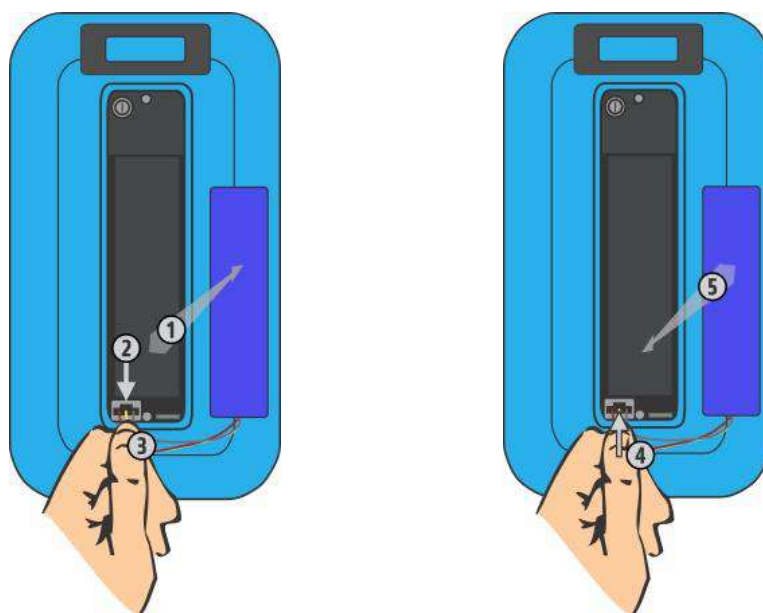

Battery pack disconnection procedure

Unscrew two screws and remove the battery / fuse compartment cover.

Remove the battery pack from battery compartment ①.

Press to unlock the connector ② and pull the wires ③ to disconnect the battery pack from the instrument.

Battery pack insertion procedure

Connect the new battery pack to the instrument ④.

Insert the battery pack into battery compartment ⑤.

Close and screw the battery / fuse compartment cover.

WARNINGS

- Switch off the instrument and disconnect all test accessories and charger from the instrument, before replacing the battery.
- Pay special attention when inserting the battery pack into the battery compartment and when closing the battery / fuse compartment cover to avoid pinched wires.

9.4 SD card maintenance

It is recommended, to regularly **backup the data stored in the instrument's SD card, to prevent potential data loss** caused by unpredictable SD card behaviour. Such issue may occur due to ageing, the excessive number of SD card write/read cycles, or excessive disturbances during SD card data transfer, resulting in possible file system error.

The instrument includes an integrated SD card self-check feature, that notifies the operator if an SD card error is detected.

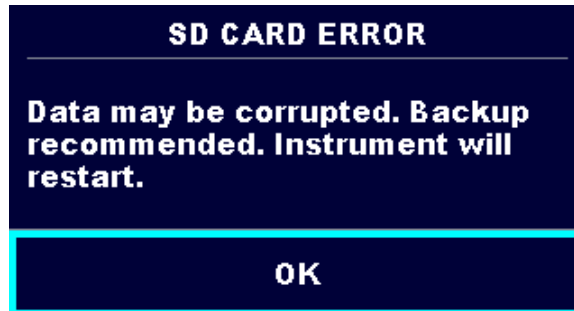

SD card error message

Troubleshooting notes:

- ▶ A quick format of the SD card is recommended. Ensure that all data is backed up before proceeding with formatting!
- ▶ Replace the SD card if formatting does not resolve the issue.

WARNING

- Switch off the instrument and disconnect all test accessories and charger from the instrument, before replacing SD card.

9.5 Service

For repairs under or out of warranty please contact your distributor for further information. Unauthorized person is not allowed to open the instrument. There are no user replaceable parts inside the instrument.

9.6 Cleaning

Use a soft, slightly moistened cloth with soap water or alcohol to clean the surface of the instrument. Leave the instrument to dry totally before using it.

WARNINGS

- Do not use liquids based on petrol or hydrocarbons!
- Do not spill cleaning liquid over the instrument!

10 Technical specifications

10.1 R iso – Insulation resistance

Uiso ≤ 250 V

Measuring range according to BS EN 61557 is 0.15 MΩ ... 199.9 MΩ.

Measuring range (MΩ)	Resolution (MΩ)	Accuracy
0.00 ... 19.99	0.01	±(5 % of reading + 3 digits)
20.0 ... 99.9	0.1	±(10 % of reading)
100.0 ... 199.9		±(20 % of reading)

Uiso: 500 V

Measuring range according to BS EN 61557 is 0.15 MΩ ... 999 MΩ.

Measuring range (MΩ)	Resolution (MΩ)	Accuracy
0.00 ... 19.99	0.01	±(5 % of reading + 3 digits)
20.0 ... 199.9	0.1	±(5 % of reading)
200 ... 999	1	±(10 % of reading)

Uiso: 1000 V

Measuring range according to BS EN 61557 is 0.15 MΩ ... 199.9 MΩ.

Measuring range (MΩ)	Resolution (MΩ)	Accuracy
0.00 ... 19.99	0.01	±(5 % of reading + 3 digits)
20.0 ... 199.9	0.1	±(5 % of reading)
200 ... 999	1	indicative

Um - Voltage

Measuring range (V)	Resolution (V)	Accuracy
0 ... 1200	1	±(3 % of reading + 3 digits)

Nominal voltages Uiso.....50 V, 100 V, 250 V, 500 V, 1000 V

Open circuit voltage.....-0 % / +20 % of nominal voltage

Measuring currentmin. 1 mA at $R_N = U_N \times 1 \text{ k}\Omega/\text{V}$

Short circuit current..... max. 3 mA

Load pretest voltage..... < 20 V_{AC}, 125 Hz

Load pretest warning..... < 50 kΩ

Number of possible tests **with a fully charged battery**..... ≤ 1000

Auto discharge after test.

Specified accuracy is valid if a 3-wire test lead is used, while it is valid up to 100 MΩ if Tip commander is used.

At measured values above 50 M Ω the error in operating conditions could be at most the error for reference conditions +20 % of measured value for every 10 % change in relative humidity from reference condition, without condensation.

In case the instrument gets moistened, it is recommended to dry the instrument and accessories for at least 24 hours.

10.2 R low – Resistance of earth connection and equipotential bonding

Measuring range according to BS EN 61557 is 0.12 Ω ... 1999 Ω .

R – Resistance

Measuring range (Ω)	Resolution (Ω)	Accuracy
0.00 ... 19.99	0.01	$\pm(3\% \text{ of reading} + 3 \text{ digits})$
20.0 ... 199.9	0.1	$\pm(5\% \text{ of reading})$
200 ... 1999	1	

R+, R – Resistance

Measuring range (Ω)	Resolution (Ω)	Accuracy
0.0 ... 199.9	0.1	$\pm(5\% \text{ of reading} + 5 \text{ digits})$
200 ... 1999	1	

Open-circuit voltage 6.5 V_{DC} to 18 V_{DC}

Measuring current min. 200 mA into load resistance of 2 Ω

Test lead compensation up to 5 Ω

The number of possible tests, with a fully charged battery

Current = standard..... ≤ 1700

Current = ramp ≤ 1200

Automatic polarity reversal of the test voltage.

10.3 Continuity – Continuous resistance measurement with low current

R – Continuity resistance

Measuring range (Ω)	Resolution (Ω)	Accuracy
0.0 ... 19.9	0.1	$\pm(5\% \text{ of reading} + 3 \text{ digits})$
20 ... 1999	1	

Open-circuit voltage 6.5 V_{DC} to 18 V_{DC}

Short-circuit current max. 8.5 mA

Test lead compensation up to 5 Ω

10.4 Ring Continuity

Measuring range according to BS EN 61557 is 0.12 Ω ... 50 Ω .

(r1,r2,rN), (R1+RN,R1+R2)

Measuring range (Ω)	Resolution (Ω)	Accuracy
0.00 ... 9.99	0.01	$\pm(3\% \text{ of reading} + 3 \text{ digits})$
10.0 ... 19.9	0.01	$\pm(5\% \text{ of reading})$
20 ... 50	0.1	$\pm(10\% \text{ of reading})$

Open-circuit voltage6.5 V_{DC} to 18 V_{DC}

Measuring currentmin. 200 mA into load resistance of 2 Ω

Test lead / adapter compensation.....up to 5 Ω

10.5 RCD testing

10.5.1 General data

Note

Applicable options depend on selected RCD/ protective device and its parameters

RCD type.....AC, A, B, F, B+, 2 pole, 3 pole, PRCD S, PRCD S+,
PRCD S pro, PRCD K, RDC DD, IC CPD, MI RCD

Nominal residual current6 mA ... 1000 mA

Test current shapesSine, Pulse, DC

Sensitivitystandard, Ipe monitoring

Selectivity.....-, S, G/KV

Test current starting polarity.....0°, 180°, Both

Standards.....EN 61008/ EN 61009, IEC 60364-4-41 TN/IT /TT, BS
7671, AS/NZS 3017, PRCD, VDE 0664, VDE 0100-410
TN/IT /TT, IEC 62752, IEC 62955

10.5.1.1 RCD trip out time limits / test duration

Trip out time limits EN 61008 / EN 61009, VDE 0664, PRCDs

	$\frac{1}{2} \times I_{\Delta N}^{(1)}$	$I_{\Delta N}$	$2 \times I_{\Delta N}$	$5 \times I_{\Delta N}$
non-delayed	$t_{\Delta} > 300 \text{ ms}$	$t_{\Delta} < 300 \text{ ms}$	$t_{\Delta} < 150 \text{ ms}$	$t_{\Delta} < 40 \text{ ms}$
S (delayed)	$t_{\Delta} > 500 \text{ ms}$	$130 \text{ ms} < t_{\Delta} < 500 \text{ ms}$	$60 \text{ ms} < t_{\Delta} < 200 \text{ ms}$	$50 \text{ ms} < t_{\Delta} < 150 \text{ ms}$

Trip out times limits IEC 60364-4-41, VDE 0100-410

	$U_0^{(2)}$	$\frac{1}{2} \times I_{\Delta N}^{(1)}$	$I_{\Delta N}$	$2 \times I_{\Delta N}$	$5 \times I_{\Delta N}$
--	-------------	---	----------------	-------------------------	-------------------------

TN / IT	≤ 120 V	$t_{\Delta} > 800$ ms	$t_{\Delta} \leq 800$ ms	$t_{\Delta} < 150$ ms	$t_{\Delta} < 40$ ms
	≤ 230 V	$t_{\Delta} > 400$ ms	$t_{\Delta} \leq 400$ ms		
TT	≤ 120 V	$t_{\Delta} > 300$ ms	$t_{\Delta} \leq 300$ ms		
	≤ 230 V	$t_{\Delta} > 200$ ms	$t_{\Delta} \leq 200$ ms		

Trip out time limits BS 7671

	$\frac{1}{2} \times I_{\Delta N}^{(1)}$	$I_{\Delta N}$	$2 \times I_{\Delta N}$	$5 \times I_{\Delta N}$
non-delayed	$t_{\Delta} > 1999$ ms	$t_{\Delta} < 300$ ms	$t_{\Delta} < 150$ ms	$t_{\Delta} < 40$ ms
S (delayed)	$t_{\Delta} > 1999$ ms	130 ms $< t_{\Delta} < 500$ ms	60 ms $< t_{\Delta} < 200$ ms	50 ms $< t_{\Delta} < 150$ ms

Trip out time limits AS/NZS 3017

	$I_{\Delta N}$ (mA)	$\frac{1}{2} \times I_{\Delta N}^{(1)}$ t_{Δ}	$I_{\Delta N}$ t_{Δ}	$2 \times I_{\Delta N}$ t_{Δ}	$5 \times I_{\Delta N}$ t_{Δ}	Note
non-delayed	≤ 10	> 999 ms	40 ms	40 ms	40 ms	Maximum break time
	> 10 ≤ 30		300 ms	150 ms	40 ms	
	> 30		300 ms	150 ms	40 ms	
S (delayed)	> 30	> 999 ms	500 ms	200 ms	150 ms	Minimum non-actuating time
			130 ms	60 ms	50 ms	

Trip out time limits IEC 62955 (dc residual currents)

6 mA ($1 \times I_{\Delta N}$)	60 mA ($10 \times I_{\Delta N}$)	200 mA ($33.33 \times I_{\Delta N}$)	300 mA ($50 \times I_{\Delta N}$)
< 10.0 s	< 300 ms	< 100 ms	×

Non-operating times IEC 62955 (a.c. residual currents)

Up to 30 mA ($1 \times I_{\Delta N}$)	60 mA ($2 \times I_{\Delta N}$)	150 mA ($5 \times I_{\Delta N}$)
No tripping	> 300 ms	> 80 ms

Trip out time limits IEC 62752 (dc residual currents)

6 mA ($1 \times I_{\Delta N}$)	60 mA ($10 \times I_{\Delta N}$)	200 mA ($33.33 \times I_{\Delta N}$)	300 mA ($50 \times I_{\Delta N}$)
< 10.0 s	< 300 ms	×	< 40 ms

Trip out time limits IEC 62752 (a.c. residual currents)

30 mA ($1 \times I_{\Delta N}$)	60 mA ($2 \times I_{\Delta N}$)	150 mA ($5 \times I_{\Delta N}$)
< 300 ms	< 150 ms	< 40 ms

Maximum test times

	Standard	$\frac{1}{2} \times I_{\Delta N}$	$I_{\Delta N}$	$2 \times I_{\Delta N}$	$5 \times I_{\Delta N}$
non delayed	EN 61008 / EN 61009	300 ms	300 ms	150 ms	40 ms
	IEC 60364-4-41	1000 ms	1000 ms	150 ms	40 ms
	BS 7671	2000 ms	300 ms	150 ms	40 ms
	AS/NZS 3017 (I, II, III)	1000 ms	1000 ms	150 ms	40 ms

	Standard	$\frac{1}{2} \times I_{\Delta N}$	$I_{\Delta N}$	$2 \times I_{\Delta N}$	$5 \times I_{\Delta N}$
S (delayed)	EN 61008 / EN 61009	500 ms	500 ms	200 ms	150 ms
	IEC 60364-4-41	1000 ms	1000 ms	150 ms	40 ms
	BS 7671	2000 ms	500 ms	200 ms	150 ms
	AS/NZS 3017 (IV)	1000 ms	1000 ms	200 ms	150 ms

¹⁾ RCD shall not trip-out.

10.5.1.2 RCD test currents

RCD Types: AC, A, B, F, B+, PRCDs

$U_n = 40 \text{ V} \dots 264 \text{ V}$ (45 Hz ... 65 Hz)

$I_{\Delta N}$ (mA)	$I_{\Delta N} \times 1/2$ (mA)			$I_{\Delta N} \times 1$ (mA)			$I_{\Delta N} \times 2$ (mA)			$I_{\Delta N} \times 5$ (mA)			RCD I_{Δ}		
	Sine	Pulse	DC	Sine	Pulse	DC	Sine	Pulse	DC	Sine	Pulse	DC	Sine	Pulse	DC
10	5	3.5	5	10	20	20	20	40	40	50	100	100	✓	✓	✓
15	7.5	5.3	7.5	15	30	30	30	60	60	75	150	150	✓	✓	✓
30	15	10.5	15	30	42	60	60	84	120	150	212	300	✓	✓	✓
100	50	35	50	100	141	200	200	282	400	500	707	1000	✓	✓	✓
300	150	105	150	300	424	600	600	848	×	1500	×	×	✓	✓	✓
500	250	175	250	500	707	1000	1000	1410	×	2500	×	×	✓	✓	✓
650	375	228	375	650	916	×	1300	×	×	×	×	×	✓	✓	×
1000	500	350	500	1000	1410	×	2000	×	×	×	×	×	✓	×	×

$U_n \geq 265 \text{ V}$ (45 Hz ... 65 Hz)

$I_{\Delta N}$ (mA)	$I_{\Delta N} \times 1/2$ (mA)			$I_{\Delta N} \times 1$ (mA)			$I_{\Delta N} \times 2$ (mA)			$I_{\Delta N} \times 5$ (mA)			RCD I_{Δ}		
	Sine	Pulse	DC	Sine	Pulse	DC	Sine	Pulse	DC	Sine	Pulse	DC	Sine	Pulse	DC
10	5	3.5	×	10	20	×	20	40	×	50	100	×	✓	✓	×
15	7.5	5.3	×	15	30	×	30	60	×	75	150	×	✓	✓	×
30	15	10.5	×	30	42	×	60	84	×	150	212	×	✓	✓	×
100	50	35	×	100	141	×	200	282	×	500	707	×	✓	✓	×
300	150	105	×	300	424	×	600	848	×	×	×	×	✓	✓	×
500	250	175	×	500	707	×	1000	1410	×	×	×	×	✓	✓	×

RCD types: RDC DD, IC-CPD, MI RCD

$U_n = 40 \text{ V} \dots 264 \text{ V} (45 \text{ Hz} \dots 65 \text{ Hz})$

Shape	$I_{\Delta N}$ (mA)	$I_{\Delta N} \times 1/2$ (mA)	$I_{\Delta N} \times 1$ (mA)	$I_{\Delta N} \times 2$ (mA)	$I_{\Delta N} \times 5$ (mA)	$I_{\Delta N} \times 10$ (mA)	$I_{\Delta N} \times 33.33$ (mA)	$I_{\Delta N} \times 50$ (mA)	RCD I_{Δ}
Sine	30	15	30	60	150	×	×	×	✓
Pulse ¹⁾	30	10.5	42	84	212	×	×	×	✓
DC	6	3	6	×	×	60	200	300	✓

¹⁾ Pulse shape is applicable for IC-CPD only.

✓applicable

×not applicable

Test current accuracy.....-0.1· I_{Δ} / +0 · I_{Δ} for $0.5 \times I_{\Delta N}$,
+0· I_{Δ} / +0.1· I_{Δ} for $(1 \dots 50) \times I_{\Delta N}$
AS/NZS 3017: ±5% of I_{Δ}

10.5.1.3 RCD I current ramp

RCD types: AC, A, F, B, B+, PRCD, MI RCD (Shape = Sine, Pulse)

Ramp range	Shape	Test current accuracy	Note
$0.2 \times I_{\Delta N} \dots 1.1 \times I_{\Delta N}$	Sine	$\pm 0.1 \times I_{\Delta N}$	
$0.2 \times I_{\Delta N} \dots 1.5 \times I_{\Delta N}$	Pulse	$\pm 0.1 \times I_{\Delta N}$	$I_{\Delta N} \geq 30 \text{ mA}$
$0.2 \times I_{\Delta N} \dots 2.2 \times I_{\Delta N}$	Pulse	$\pm 0.1 \times I_{\Delta N}$	$I_{\Delta N} < 30 \text{ mA}$
$0.2 \times I_{\Delta N} \dots 2.2 \times I_{\Delta N}$	DC	$\pm 0.1 \times I_{\Delta N}$	

RCD types: RDC DD, MI RCD (Shape = DC)

Ramp range	Shape	Accuracy	Note
$0.2 \times I_{\Delta N} \dots 1.0 \times I_{\Delta N}$	Sine	$\pm 0.1 \times I_{\Delta}$	
$0.2 \times I_{\Delta N, d.c.} \dots 1.0 \times I_{\Delta N, d.c.}$	DC	$\pm 0.1 \times I_{\Delta, d.c.}$	

RCD type: IC CPD

Ramp range	Shape	Accuracy	Note
$0.2 \times I_{\Delta N} \dots 1.0 \times I_{\Delta N}$	Sine	$\pm 0.1 \times I_{\Delta}$	
$0.0 \times I_{\Delta N} \dots 1.4 \times I_{\Delta N}$	Pulse	$\pm 0.1 \times I_{\Delta}$	
$0.0 \times I_{\Delta N, d.c.} \dots 1.0 \times I_{\Delta N, d.c.}$	DC	$\pm 0.1 \times I_{\Delta, d.c.}$	

10.5.1.4 RCD U_c

RCD parameters			Contact voltage U_c
Shape	Selectivity	$I_{\Delta N}$	proportional to
Sine	-	any	$1.05 \times I_{\Delta N}$
Sine	S		$2 \times 1.05 \times I_{\Delta N}$
Pulse	-	$\geq 30 \text{ mA}$	$1.4 \times 1.05 \times I_{\Delta N}$

Pulse	S		$2 \times 1.4 \times 1.05 \times I_{\Delta N}$
Pulse	-	< 30 mA	$2 \times 1.05 \times I_{\Delta N}$
Pulse	S		$2 \times 2 \times 1.05 \times I_{\Delta N}$
DC	-	any	$2 \times 1.05 \times I_{\Delta N}$
DC	S		$2 \times 2 \times 1.05 \times I_{\Delta N}$

Notes

- If the RCD supports only sinusoidal current, the U_c result is based on the sinusoidal shape.
- If the RCD supports both sinusoidal and pulsed currents, the U_c result is based on the pulsed shape.
- If the RCD supports sinusoidal, pulsed, and direct current, the U_c result is based on the DC shape.

10.5.2 RCD t – Trip-out time

Trip-out time

Measuring range (s)	Resolution (ms)	Accuracy
0.0 m ... 40.0 m	0.1	± 1 ms
40.1 m ... 999.9 m	0.1	± 3 ms
1000 m ... 1999 m	1	
2.00 ... 10.00	10	± 10 ms

10.5.3 RCD I – Trip-out current

Trip-out current

Measuring range (A)	Resolution (mA)	Accuracy
0.1 m ... 99.9 m	0.1	± 10 %
100 m ... 999 m	1	
1.00 ... 1.10	10	

10.5.4 U_c - Contact voltage

Measuring range according to BS EN 61557 is 20.0 V ... 99.0 V

 U_c - Contact voltage

Measuring range (V)	Resolution (V)	Accuracy
0.0 ... 19.9	0.1	(-0 % / +15 %) of reading ± 10 digits
20.0 ... 99.9	0.1	(-0 % / +15 %) of reading

The accuracy is valid if mains voltage is stable during the measurement and PE terminal is free of interfering voltages. Specified accuracy is valid for complete operating range.

RL - Loop resistance

Measuring range (Ω)	Resolution (Ω)	Accuracy
0 ... 9999	1	Calculated value $R_L = U_C / I_{\Delta N}$

Test current max. $0.3 \times I_{\Delta N}$

10.5.5 RCD Auto

For technical specification refer to chapter 10.5 RCD testing for technical specification of individual RCD tests.

10.6 Z loop - Fault loop impedance and prospective fault current

Z - Fault loop impedance

Measuring range according to BS EN 61557 is 0.12 Ω ... 9.99 k Ω .

Measuring range (Ω)	Resolution (Ω)	Accuracy
0.00 ... 9.99	0.01	$\pm(3\% \text{ of reading} + 3 \text{ digits})$
10.0 ... 99.9	0.1	
100 ... 999	1	$\pm 10\% \text{ of reading}$
1.00 k ... 9.99 k	10	

Ipsc - Prospective fault current

Measuring range (A)	Resolution (A)	Accuracy
0.00 ... 9.99	0.01	Consider accuracy of fault loop impedance measurement
10.0 ... 99.9	0.1	
100 ... 999	1	
1.00 k ... 9.99 k	10	
10.0 k ... 23.0 k	100	

Ulpe - Voltage

Measuring range (V)	Resolution (V)	Accuracy
0 ... 550	1	$\pm(2\% \text{ of reading} + 2 \text{ digits})$

The accuracy is valid if mains voltage is stable during the measurement.

Test current (at 230 V) 7 A

Voltage range 30 V ... 485 V (45 Hz ... 65 Hz)

Nominal voltage range 93 V ... 159 V, 185 V ... 266 V

R and X_L results are indicative.

For voltages < 93 V, all results are indicative.

10.7 Zs rcd – Fault loop impedance and prospective fault current in system with RCD

Z – Fault loop impedance

Measuring range according to BS EN 61557 is 0.46 Ω ... 9.99 k Ω for I test = standard and 0.48 Ω ... 9.99 k Ω for I test = low.

Measuring range (Ω)	Resolution (Ω)	Accuracy I test = standard	Accuracy I test = low
0.00 ... 9.99	0.01	$\pm(5\% \text{ of reading} + 10 \text{ digits})$	$\pm(5\% \text{ of reading} + 12 \text{ digits})$
10.0 ... 99.9	0.1		
100 ... 999	1	$\pm 10\% \text{ of reading}$	$\pm 10\% \text{ of reading}$
1.00 k ... 9.99 k	10		

Accuracy may be impaired in case of heavy noise on mains voltage.

Ipsc – Prospective fault current

Measuring range (A)	Resolution (A)	Accuracy
0.00 ... 9.99	0.01	Consider accuracy of fault loop impedance measurement
10.0 ... 99.9	0.1	
100 ... 999	1	
1.00 k ... 9.99 k	10	
10.0 k ... 23.0 k	100	

U_{lpe} – Voltage

Measuring range (V)	Resolution (V)	Accuracy
0 ... 550	1	$\pm(2\% \text{ of reading} + 2 \text{ digits})$

U_c – Contact voltage

Measuring range (V)	Resolution (V)	Accuracy
0.0 ... 99.9	0.1	Relative accuracy of U _c is equal to relative accuracy of Z

Voltage range 30 V ... 485 V (45 Hz ... 65 Hz)

Nominal voltage range 93 V ... 159 V, 185 V ... 266 V

No trip out of RCD.

R, X_L values are indicative.

For voltages < 93 V, all results are indicative.

10.8 Z line – Line impedance and prospective short-circuit current

Z – Line impedance

Measuring range according to BS EN 61557 is 0.12 Ω ... 9.99 k Ω .

Measuring range (Ω)	Resolution (Ω)	Accuracy
0.00 ... 9.99	0.01	$\pm(3\% \text{ of reading} + 3 \text{ digits})$
10.0 ... 99.9	0.1	
100 ... 999	1	$\pm 10\% \text{ of reading}$
1.00 k ... 9.99 k	10	

I_{psc} – prospective short-circuit current

I_{max} – Maximal single-phase prospective short-circuit current

I_{max2p} – Maximal two-phases prospective short-circuit current

I_{max3p} – Maximal three-phases prospective short-circuit current

Measuring range (A)	Resolution (A)	Accuracy
0.00 ... 0.99	0.01	Consider accuracy of line impedance measurement
1.0 ... 99.9	0.1	
100 ... 999	1	
1.00 k ... 99.99 k	10	
100 k ... 199 k	1000	

U_{In} – Voltage

Measuring range (V)	Resolution (V)	Accuracy
0 ... 550	1	$\pm(2\% \text{ of reading} + 2 \text{ digits})$

Test current (at 230 V)..... 7 A

Voltage range 30 V ... 485 V (**45 Hz ... 65 Hz**)

Nominal voltage range 93 V ... 134 V, 185 V ... 266 V, 321 V ... 485 V

R , X_L , I_{min} , I_{min2p} , I_{min3p} values are indicative.

For voltages < 93 V, all results are indicative.

10.9 Voltage Drop

ΔU – Voltage drop

Measuring range (%)	Resolution (%)	Accuracy
0.0 ... 99.9	0.1	Consider accuracy of line impedance measurement(s)

Z_{REF} measuring range.....0.00 Ω ... 20.0 Ω

Test current (at 230 V)..... 7 A

Voltage range 30 V ... 485 V (**45 Hz ... 65 Hz**)

Nominal voltage range 93 V ... 134 V, 185 V ... 266 V, 321 V ... 485 V

10.10 Rpe – PE conductor resistance

RCD: No

R – PE conductor resistance

Measuring range (Ω)	Resolution (Ω)	Accuracy
0.00 ... 19.99	0.01	$\pm(5\% \text{ of reading} + 5 \text{ digits})$
20.0 ... 199.9	0.1	
200 ... 1999	1	

Measuring currentmin. 200 mA into PE resistance of 2 Ω

RCD: Yes, no trip out of RCD

R – PE conductor resistance

Measuring range (Ω)	Resolution (Ω)	Accuracy
0.00 ... 19.99	0.01	$\pm(5\% \text{ of reading} + 10 \text{ digits})$
20.0 ... 99.9	0.1	
100.0 ... 199.9	0.1	$\pm 10\% \text{ of reading}$
200 ... 1999	1	

Accuracy may be impaired in case of heavy noise on mains voltage.

Measuring current < 15 mA

Voltage range 30 V ... 485 V (45 Hz ... 65 Hz)

10.11 **AUTO TT, AUTO TT_{rcd}, AUTO TN, AUTO TN_{rcd}**

Z(LPE) in AUTO TT and AUTO TN:

Measuring range according to BS EN 61557 is 0.20 Ω ... 9.99 k Ω .

Measuring range (Ω)	Resolution (Ω)	Accuracy
0.00 ... 9.99	0.01	$\pm(5\% \text{ of reading} + 5 \text{ digits})$
10.0 ... 99.9	0.1	
100 ... 999	1	
1.00 k ... 9.99 k	10	

I_{psc} – Prospective fault current

Measuring range (A)	Resolution (A)	Accuracy
0.00 ... 9.99	0.01	Consider accuracy of fault loop impedance measurement Z(LPE)
10.0 ... 99.9	0.1	
100 ... 999	1	
1.00 k ... 9.99 k	10	
10.0 k ... 23.0 k	100	

The accuracy is valid if mains voltage is stable during the measurement.

Voltage range 30 V ... 485 V (45 Hz ... 65 Hz)

Nominal voltage range 93 V ... 159 V, 185 V ... 266 V

For voltages < 93 V, all results are indicative.

For other technical specifications refer to sections:

Z(LPE) in AUTO TT_{rcd}, AUTO TN_{rcd}, U_c:

[10.7 Z_{s rcd} – Fault loop impedance and prospective fault current in system with RCD](#)

Z(LN), Z_{ref}, U_{In}:

[10.8 Z_{line} – Line impedance and prospective short-circuit current](#)

ΔU :

[10.9 Voltage Drop](#)

R_{pe} in AUTO TN and AUTO TNrcd:

[10.10 R_{pe} – PE conductor resistance](#)

10.12 Earth – Earth resistance (3-wire measurement)

R_e – Earth resistance

Measuring range according to EN61557-5 is 0.20 Ω ... 1999 Ω.

Measuring range (Ω)	Resolution (Ω)	Accuracy
0.00 ... 19.99	0.01	±(5 % of reading + 5 digits)
20.0 ... 199.9	0.1	
200 ... 9999	1	

Max. auxiliary earth electrode resistance R_C100×R_E or 50 kΩ (whichever is lower)

Max. probe resistance R_P100×R_E or 50 kΩ (whichever is lower)

R_C and R_P values are indicative.

Additional probe resistance error at R_{Cmax} or R_{Pmax} ...±(10 % of reading + 10 digits)

Additional error at 3 V voltage noise (50 Hz)±(5 % of reading + 10 digits)

Open circuit voltage< 30 VAC

Short circuit current< 30 mA

Test signal125 Hz sine wave

Noise voltage indication threshold1 V (< 50 Ω, worst case)

10.13 Voltage, frequency, and phase rotation

10.13.1 Phase rotation

Nominal system voltage range 100 V_{AC} ... 550 V_{AC}

Nominal frequency range 14 Hz ... 500 Hz

Result displayed 1.2.3 or 3.2.1

10.13.2 Voltage / Online terminal voltage monitor

Measuring range (V)	Resolution (V)	Accuracy
0 ... 550	1	±(2 % of reading + 2 digits)

Result type True r.m.s. (TRMS)

Nominal frequency range 0 Hz, 14 Hz ... 500 Hz

10.13.3 Frequency

Measuring range (Hz)	Resolution (Hz)	Accuracy
14.0 ... 499.9	0.1	±(0.2 % of reading + 1 digit)

Nominal voltage range 20 V ... 550 V

10.13.1 Phase rotation

Nominal system voltage range	100 V _{AC} ... 550 V _{AC}
Nominal frequency range	14 Hz ... 500 Hz
Result displayed.....	1.2.3 or 3.2.1

10.14 Auto Sequences®

Refer to each individual test (measurement) for detailed technical specification.

10.15 Diagnostic Test (EVSE) (A 1632)

This test is performed in combination with an external test adapter / instrument.
For technical specification refer to [A 1632 eMobility Analyzer Instruction manual](#).

10.16 General data

Battery

Battery	Li-Ion battery pack
	7.2 V, 5200 mAh, type: INR18650-2S2P
Operation	Typical 14 h
Typical charging time	2.5 hours
Battery charging current	≤ 3 A
Charger socket / charging voltage.....	USB Type-C PD, 12 V d.c., 15 V d.c.
Charger power output	≥ 45 W

Measuring categories

Measuring category	600 V CAT III, 300 V CAT IV
3-wire test lead:	600 V CAT III, 300 V CAT IV
Plug test cable:.....	300 V CAT II
Altitude	≤ 2000 m

Protection classifications

Protection classification	double insulation
Pollution degree	2
Protection degree	IP 40
Case.....	Shock proof plastic / portable
Operation	Indoor use

Display

Display.....	Colour TFT display, 4.3 inch (10.9 cm), 480 x 272 pixels
Touch screen	Capacitive

Communication ports, memory

Memory	depends on microSD card size
--------------	------------------------------

USB	Standard USB Type-C 2.0
Bluetooth	Class 1
EMC	
Emission.....	Class B (Group 1)
Immunity	Basic electromagnetic environment (Portable test and measurement equipment)
Reference conditions	
Reference temperature range.....	10 °C ... 30 °C
Reference humidity range	40 %RH ... 60 %RH
Operation conditions	
Working temperature range	0 °C ... 40 °C
Maximum relative humidity	90 %RH (0 °C ... 40 °C), non-condensing
Storage conditions	
Temperature range	-10 °C ... +70 °C
Maximum relative humidity	90 %RH (-10 °C ... +40 °C) 80 %RH (40 °C ... 60 °C)
General	
Dimensions (w × h × d)	15 cm × 8 cm × 28 cm
Weight	1.35 kg, with battery pack
Locator	
Locator	supports inductive mode
Maximum operation voltage	440 V a.c.

The error in operating conditions could be at most the error for reference conditions (specified in the manual for each function) +1 % of measured value + 1 digit, unless otherwise specified in the manual for particular function.

Appendix A Commanders (A 1314-UK, A 1401)

A.1 Warnings related to safety

Measuring category of commanders

Plug commander A 1314-UK 300 V CAT II

Tip commander A 1401

(cap off, 18 mm tip) 1000 V CAT II / 600 V CAT II / 300 V CAT II

(cap on, 4 mm tip) 1000 V CAT II / 600 V CAT III / 300 V CAT IV

WARNINGS

- Measuring category of commanders can be lower than protection category of the instrument.
- If dangerous voltage is detected on the tested PE terminal, immediately stop all measurements, find and remove the fault!
- When replacing battery cells or before opening the battery compartment cover, disconnect the measuring accessory from the instrument and installation.
- Service, repairs or adjustment of instruments and accessories is only allowed to be carried out by competent authorized personnel!

A.2 Battery

The commander uses two AAA size alkaline or rechargeable Ni-MH battery cells.

Nominal operating time is at least 40 h and is declared for cells with nominal capacity of 850 mAh.

Notes

- If the commander is not used for a long period of time, remove all batteries from the battery compartment.
- Alkaline or rechargeable Ni-MH batteries (size AAA) can be used. Metrel recommends only using rechargeable batteries with a capacity of 800 mAh or above.
- Ensure that the battery cells are inserted correctly otherwise the commander will not operate and the batteries could be discharged.

A.3 Description of commanders

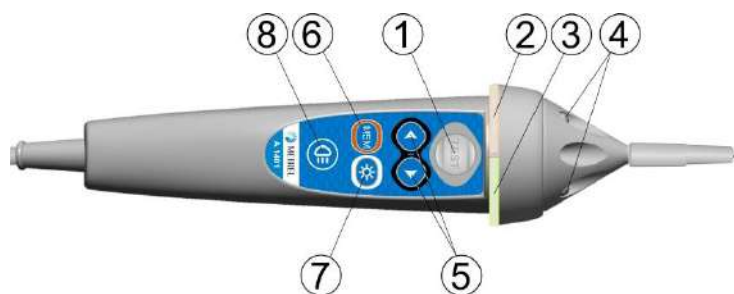

Front side Tip commander (A 1401)

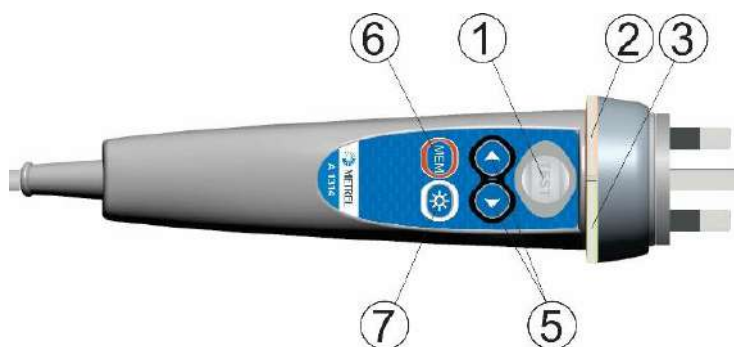

Front side Plug commander (A 1314-UK)

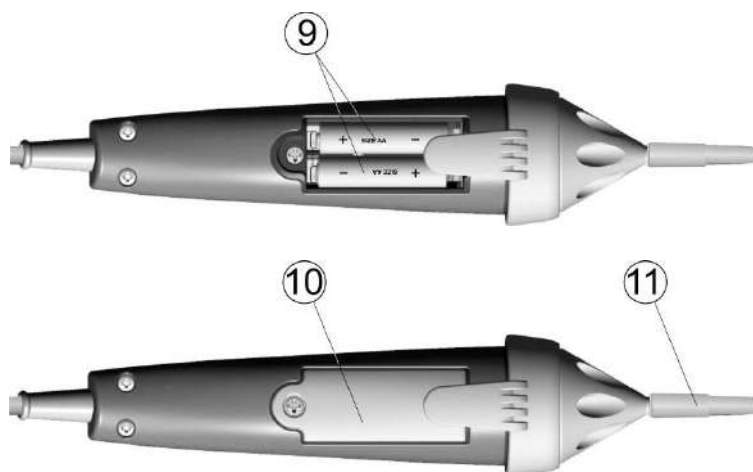

Back side

1	TEST	TEST	Starts measurements. Acts also as the PE touching electrode.
2	LED	Left status RGB LED	
3	LED	Right status RGB LED	
4	LEDs	Lamp LEDs (Tip commander)	
5	Function selector	Selects test function.	
6	MEM	Store / recall / clear tests in memory of instrument.	
7	BL	Switches On / Off backlight on instrument	
8	Lamp key	Switches On / Off lamp (Tip commander)	
9	Battery cells	Size AAA, alkaline / rechargeable Ni-MH	
10	Battery cover	Battery compartment cover	

11	Cap	Removable CAT IV cap (Tip commander)
----	-----	--------------------------------------

A.4 Operation of commanders

Both LED yellow	Warning! Dangerous voltage on the commander's PE terminal!
Right LED red	Fail indication
Right LED green	Pass indication
Left LED blinks blue	Commander is monitoring the input voltage.
Left LED orange	Voltage between any test terminals is higher than 50 V.
Both LEDs blink red	Low battery
Both LEDs red and switch off	Battery voltage too low for operation of commander

Appendix B Locator receiver R10K (A 1191)

The highly sensitive hand-held receiver R10K detects the fields caused by the currents in the traced line. It generates sound and visual output according to the signal intensity. The operating mode switch in the head detector should always be set in IND (inductive) mode. The CAP (capacitive) operating mode is intended for operating in combination with other Metrel measuring equipment.

The built in field detector is placed in the front end of the receiver. External detectors can be connected via the rear connector.

Traced object must be energized when working with the EurotestCOMBO XC.

Detectors	Operation
In built inductive sensor (IND)	Tracing hidden wires.
Current clamp (optional)	Connected through the rear connector. Locating wires.
Selective probe	Connected through the rear connector. Locating fuses in fuse cabinets.

























The user can choose between three sensitivity levels (low, middle and high). An extra potentiometer is added for fine sensitivity adjustment. A buzzer sound and 10-level LED bar graph indicator indicates the strength of the magnetic field e.g. proximity of the traced object.

Note







- The field strength can vary during tracing. The sensitivity should always be adjusted to optimum for each individual tracing.

Appendix C Structure objects in EurotestCOMBO XC

Structure elements used in Memory Organizer are instrument's Profile dependent.

Symbol	Default name	Description
	Node	Node
	Object	Object
	Dist. board	Distribution board
	Sub D. Board	Sub Distribution board
	Local bonding	Local equipotential bonding
	Water Service	Protective conductor for Water service
	Oil service	Protective conductor for Oil service
	Lightn. protect.	Protective conductor for Lightning protection
	Gas service	Protective conductor for Gas service
	Struct. steel	Protective conductor for Structural steel
	Other service	Protective conductor for Other incoming service
	Earthing cond.	Earthing conductor
	Circuit	Circuit
	Connection	Connection
	Socket	Socket
	Connection 3-ph	Connection - 3 phase
	Light	Light
	Socket 3-ph	Socket - 3 phase
	RCD	RCD
	MPE	MPE
	Foundation gr.	Protective conductor for Foundation ground
	Equip. bond. rail	Equipotential bonding rail

Symbol	Default name	Description
	House water m.	Protection conductor for House water meter
	Main water p.	Protection conductor for Main water pipes
	Main gr. cond.	Main grounding conductor
	Inter. gas inst.	Protective conductor for Interior gas installation
	Heat.inst.	Protective conductor for Heating installation
	Air cond. inst.	Protective conductor for Air conditioning installation
	Lift inst.	Protective conductor for Lift installation
	Data proc. Inst.	Protective conductor for Lift Data processing installation
	Teleph. Inst.	Protective conductor for Telephone installation
	Lightn. prot. syst.	Protective conductor for Lightning protection system
	Antenna inst.	Protective conductor for Antenna installation
	Build. Constr.	Protective conductor for Building construction
	Other conn.	Other connection
	Earth electrode	Earth electrode
	Lightning Sys.	Lightning System
	Lightning. electr.	Lightning electrode
	Inverter	Inverter
	String	String array
	Module	Module
	EVSE	Electro-Vehicle supply Equipment
	AC	EVSE AC output
	CCS	EVSE CCS output
	CHAdeMO	EVSE CHAdeMO output

Symbol	Default name	Description
	Level 1	Level 1
	Level 2	Level 2
	Level 3	Level 3
	Varistor	Varistor
	LS connection	LS connection
	Machine	Machine
	Appliance	Appliance (PRCD)
