

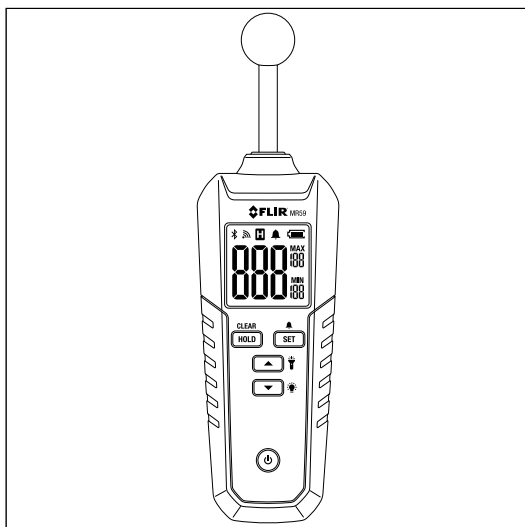

Quick Start

Ball Probe Moisture Meter with Bluetooth®

Model MR59





Quick Start

INTRODUCTION

To obtain the detailed user manual, please visit the MR59 product page on the FLIR website. Please read the user manual carefully before use.

QUICK STEPS





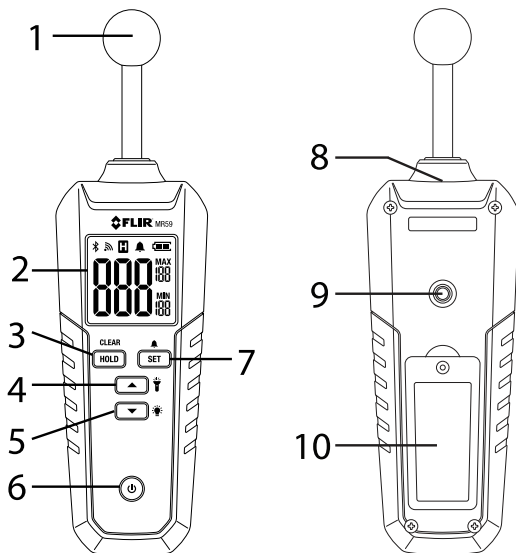

1. Ensure that a 9V battery is installed in the meter's rear compartment.
2. Long press the power button  to switch the meter ON. The meter will display 'CAL' while it performs a ZERO calibration (keep hands and objects away from sensor during this calibration).
3. The meter automatically switches OFF after 30 minutes (APO).
4. Place the ball sensor on the surface of the material under test. The sensitivity of the sensor is uniform across its entire surface. The sensor can detect moisture to a depth of 4 in (100 mm) maximum.
5. Read the moisture level in % on the meter display. Take readings in several locations for the best representation of the moisture present.
6. Note the MAX and MIN moisture readings on the display. Long press the **CLEAR** button to reset the MAX/MIN readings.
7. Long press the  button to switch the meter's backlight ON/OFF.
8. Long press the  button to switch the meter's Work Light ON/OFF.
9. To freeze/unfreeze a displayed reading, short press the **HOLD** button.
10. The MR59 beeps when the moisture reading exceeds the high alarm limit. To set the alarm limit, short press the **SET** button, and then use the up /down arrows to set the value (press **SET** again to exit). To enable/disable the alarm, long press the **SET** button. When the alarm is enabled (default), the alarm bell icon appears.
11. Refer to the Bluetooth section below, and the separate user manual, for information on transmitting readings to a remote device.

METER DESCRIPTION



1. Moisture sensor
2. Backlit LCD
3. Data Hold/MIN-MAX clear
4. Worklight ON/OFF and up arrow button
5. Backlight ON/OFF and down arrow button
6. Power button
7. Alarm SET/Alarm limit button
8. Work light
9. Tripod mount
10. Battery compartment

FUNCTION BUTTONS

	Long press to power the meter ON/OFF
CLEAR HOLD	Long press to clear MIN/MAX memories Short press to access/exit Data Hold mode
 SET	Long press to enable/disable the audible Alarm Short press SET to access/exit the alarm threshold screen (use the arrow buttons to change the threshold value)
	In Alarm limit mode, increase the moisture alarm threshold
	In Alarm limit mode, decrease the moisture alarm threshold
	Long press to switch work light ON/OFF
	Long press to the switch display backlight ON/OFF

DISPLAY DESCRIPTION

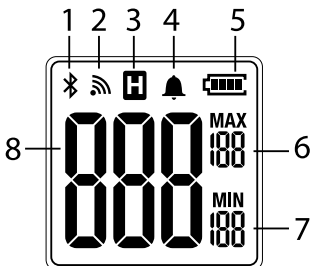



1. Bluetooth (BLE) icon (when connected)
2. Transmit icon (when connected)
3. Data Hold icon
4. Alarm enabled icon
5. Battery status icon
6. Maximum reading
7. Minimum reading
8. Moisture reading

BLUETOOTH COMMUNICATION

To connect to a smart device running the METERLiNK® app, turn on the smart device and launch the METERLiNK application. Open Instruments, and search for the MR59 (the MR59 must be ON). Tap to connect to the MR59. When connected to a device running the METERLiNK app, the MR59 continually sends readings for live display on the smart device.

When connected to a compatible FLIR camera that supports BLE (Bluetooth Low Energy), the MR59 continually sends meter readings for live display on the camera. Download the METERLiNK app from Google Play™ or the App Store®.

1. When successful communication between the meter and a remote device or FLIR camera is established, the Bluetooth icon  and the transmission icon  appear on the meter display.
2. Refer to the METERLiNK help utility in the app for general instructions.

Customer Support

Customer Support Telephone List	https://support.flir.com/contact
Repair, Calibration, and Technical Support	https://support.flir.com

Limited 3-Year Warranty

This product is protected by FLIR's Limited 3-Year Warranty. Visit www.flir.com/testwarranty to read the warranty document.



Quick Start

Website

<http://www.flir.com>

Customer support

<http://support.flir.com>

Copyright

© 2025, FLIR Systems, Inc. All rights reserved worldwide.

Disclaimer

Specifications subject to change without further notice. Models and accessories subject to regional market considerations. License procedures may apply. Products described herein may be subject to US Export Regulations. Please refer to exportquestions@flir.com with any questions.

Publ. No.: NAS100096
Release: AC
Commit: 106859
Head: 106892
Language: en-US
Modified: 2025-08-13
Formatted: 2025-08-13

