



Phase to phase fault locator

Instruction Manual



Operational user guide for the Phase to phase fault locator







Contents

Safety	4
General description	6
Connection of the  fault locator	7
Using the  fault locator	11
Specification	17
Accessories	19
Maintenance	19

Safety

Users of the  fault locator must:

- Be competent and authorised for the connection and use of test equipment on the live low voltage distribution network
- Read and understand the contents of this instruction manual
- Seek advice when unsure

B&W technologies does not take responsibility for any loss caused by the  fault locator including actions taken following its use.

ELECTRIC SHOCK RISK

The device does not generate electricity. When connecting to the live electricity network the connection lead ends may pose a risk of electric shock and should be connected using safe practices and procedures for connecting to a live network.



Connectors or leads should be examined for damage and replaced before use if necessary.



READ INSTRUCTION MANUAL BEFORE USE

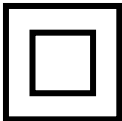

INSTRUMENT PROTECTED BY REINFORCED INSULATION



This device is for professional use only. appropriate working practices must be in place and followed in accordance with Health and Safety legislation. Instruction and training on the  is available.



Always use this product in the manner specified in the documentation or the protection provided by the equipment may be impaired. The device has no user serviceable parts.



Follow safe electrical working practices as specified in local and national instructions and codes.



Disconnect from the system before removing test leads.



The device must only be operated by suitably trained, competent persons following approved safe systems of work with appropriate training on the  device.



The  is designed to withstand limited inadvertent connections to 415V nominal voltage. Continual exposure to overvoltage is not recommended.



Device is weatherproof (IP67) when lid is closed (IP54) with lid open.



The Device is not for use at an altitude above 2000M



No need to earth device – plastic construction, double insulation and other insulating techniques.



Take care when closing lid to ensure voltage leads are not trapped. Cables should be neatly stowed.



The  is intended to be used for providing distance to fault information only.

General Description

The phase to phase  by B&W Technologies is an electrical test instrument for pinpointing the location of a fault on the electricity distribution network where two phases are welded together. The device connects to the energised low voltage network and works by taking readings whilst switching loads in and out. From the results of the on load testing it calculates distance to fault. The user then inputs cable types and lengths on the touch screen until the device offers a geographical location of the point of fault.

The device has been configured with the user in mind with the benefit of step by step instructions for operation presented on the display screen. The user simply follows these instructions and answers the on screen questions.

Connection of the fault locator

The fault locator is designed to be connected at either an LV board/pillar or underground linkbox which are being used to feed the phase to phase fault.

The device has 2 inputs, a 250V (RMS) max single phase live and neutral input, and a 30V (RMS) max voltage sensing input.



The live and neutral inputs (labelled L and N) are used to power the device and also to apply test loads to the cable under test. This input is not designed to operate over the 250V RMS max and damage could occur if connected to higher voltages. **If inadvertently connected to 415V an error ‘over voltage’ message will be displayed.**



The second input is a voltage sensing input (labelled S and S). It is used to measure the differential voltage between the 2 ends of the cable. They have a 30V RMS max measuring ability.



Provided with the fault locator are 4 x 1.5m 1000v CATIV fused test leads with crocodile clip ends. 1 x blue lead for connection to the system neutral, 2 x red sensing leads and 1 x brown for connection to the out of phase live being energised by the fault. Correct placement of the test leads is crucial for correct operation of the  fault locator, refer to connection diagrams.



The 2 X Red leads are fitted with FF0.5A HRC Fuses, and the brown and blue leads are fitted with FF6.3A HRC Fuses both (6.3mm x 32mm) Fuses with a breaking capacity of 50KA. (SIBA Part number 70-125-40) Fuses **must** only be replaced with the same type and rating.



The  fault locator **must** only be used with the supplied test leads and test clips.



Ensure the test clips are connected to the fused end of the test leads (the larger end of the lead marked with a fuse symbol).



Ensure test leads are plugged in to to the fault locator before connection to the live network, and disconnected from the live network before the test leads are removed from the fault locator.



Adhere to suitable safety measures when connecting to live networks

On the next page are connection diagrams for different types of phase to phase faults.

The Test leads should be connected to the network as shown.

Example connections for L1 feeding L2 fault

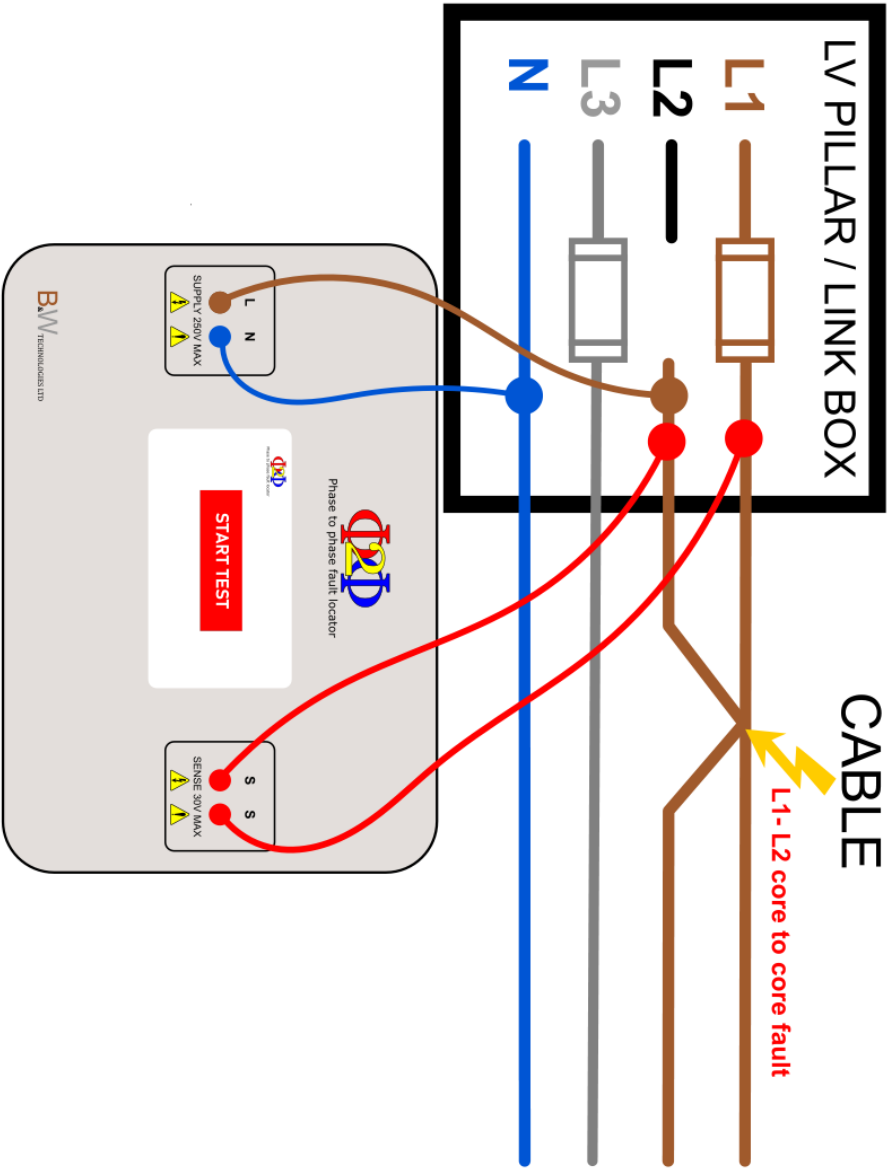

Example connections for L2 feeding L3 fault

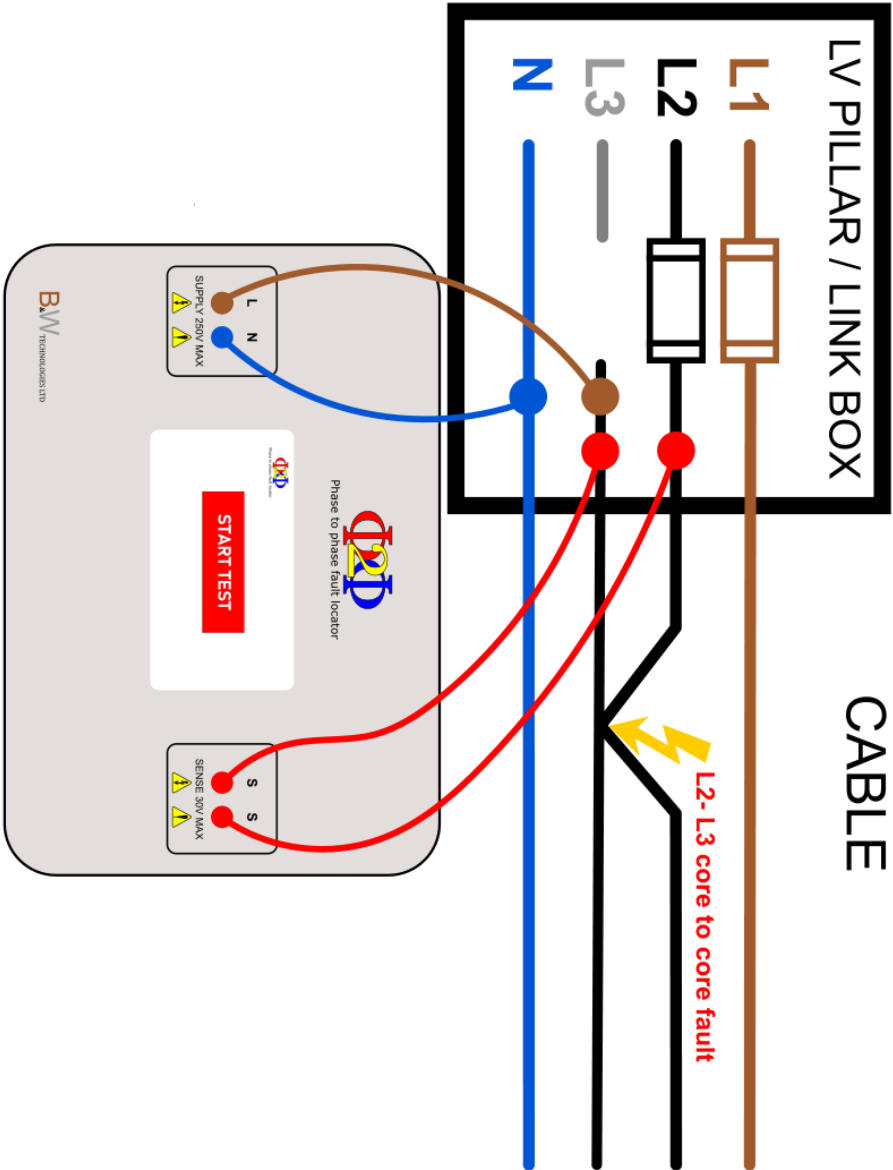

Using the fault locator

The device is powered from the mains and does not require batteries. On Connection the device touchscreen display will start up as below.

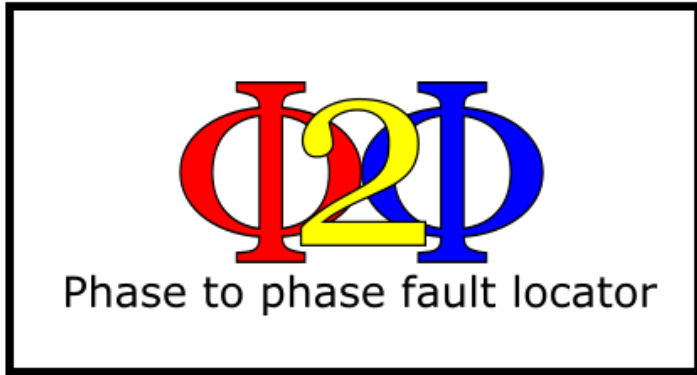

After a few seconds

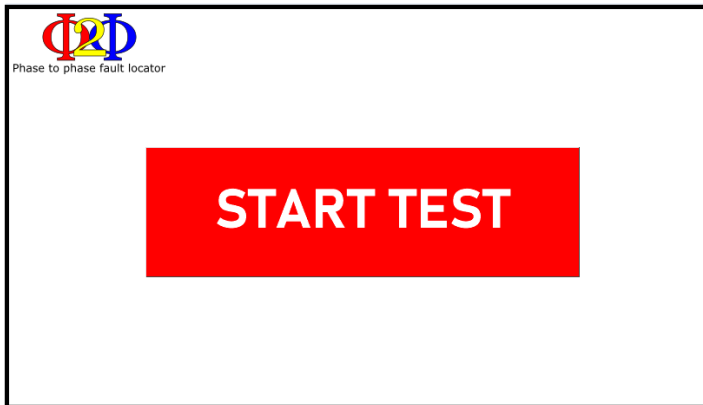

Once fully connected as per the connection diagram, the user should select “START TEST” on the touch screen and the screen will change to show testing has started.

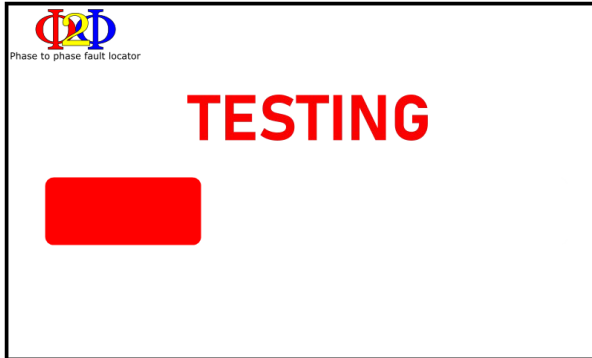

After testing is complete the user is prompted to enter the month of the year.

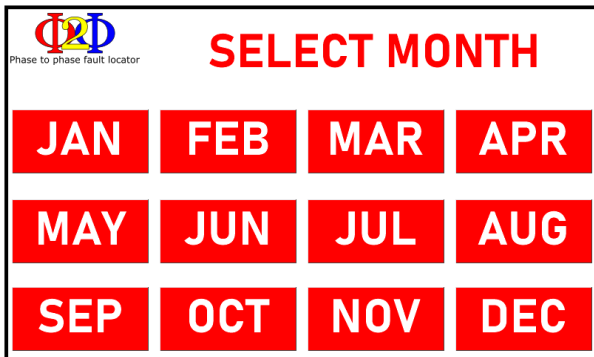

Once the month has been entered the device will ask for cable details of the network starting at the point where the device has been connected. Cable details are asked for in sections, a new section is needed when the cable type changes along the network.

Type and size of cable are all to be selected from pre-loaded tables and length in metres is entered manually. Select cable type from the options on the screen. The device will then ask for cable size.

If the network branches enter the cable details up to the branch position, then enter the cable details of the branch to its end. If the device is still asking for more cable sections after this then the fault cannot be up that branch, if the device gives a distance to fault up the branch make note of the possible position. In both cases use the re-start cable selection button to enter a new route again starting from where the device has been connected.

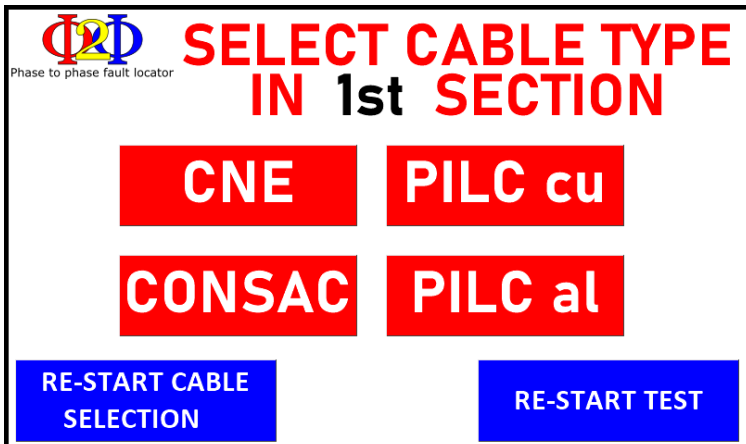

Cable size is selected from one of the below on screen options.

 **CNE SIZE**

35	70	95
120	185	300

 **PILC cu SIZE**

0.225	0.04	0.06
0.1	0.15	0.2
0.25	0.3	0.4

 **CONSAC SIZE**

70	95	120
150	185	240

 **PILC al SIZE**

0.1	0.15	0.2
0.25	0.3	0.5
95	185	300

The user will then be asked for the length of cable in the section.

This is the length of continuous cable of the type and size. Straight joints can be ignored if the same cable type and size continues after the joint. This value can be entered directly.

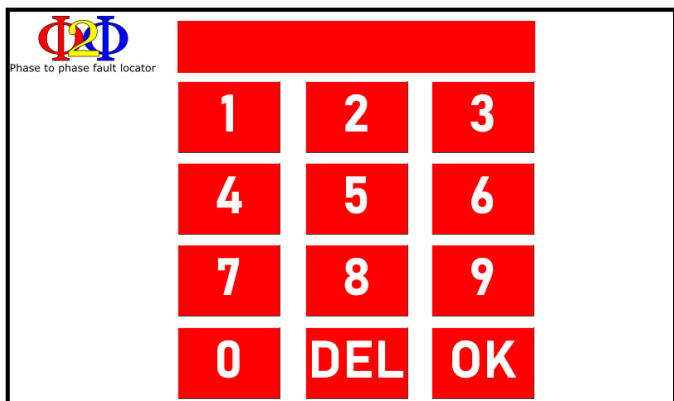
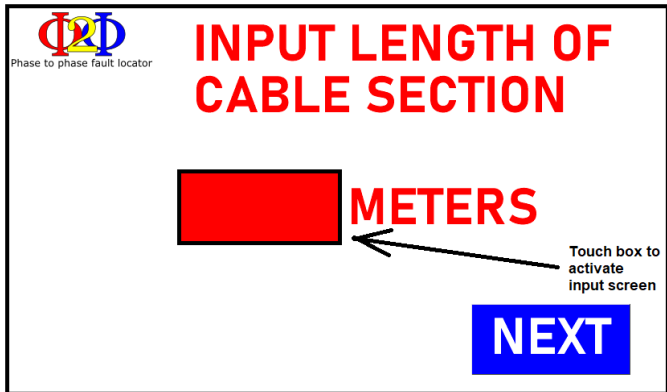

The device will ask for second and third sections until the locator has sufficient information to offer a location of the fault. This will be

displayed as a distance into the last section entered. This is the distance from the last input joint position to the fault.

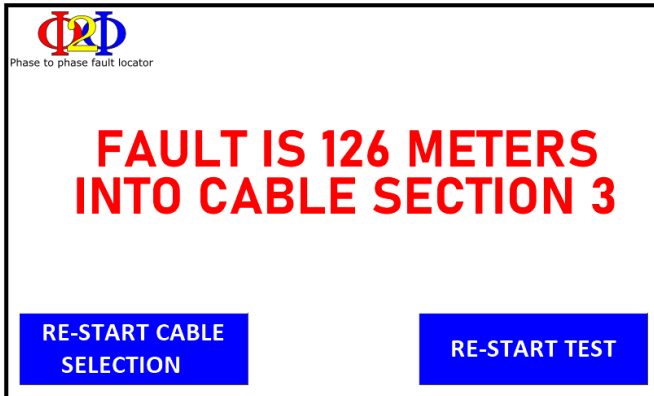

Re-start cable selection can be used to input new cable data starting from the beginning helpful if the network branches or a mistake is made when imputing cable data.

Re-start test can be used to carry out a new test to confirm fault position. It is recommended to carry out more than one test as network load changes and voltage spikes can alter results.

If the network has an alternative infeed from a network link box. It is useful to carry out a test from this position. Reconfigure the network to feed into the phase to phase fault from the link box by inserting all of the in phase links or fuses and remove all fuses from the original infeed position. re-test from the link box now feeding the fault. The correct location will be the one that correlates with the readings from the original test position.

Specifications

Connections	<p>L and N input (live and neutral)</p>	<p>216V – 253 V rms a.c. 50Hz</p> <p>Input can withstand inadvertent connection to 415 V</p> <p>error message will be displayed when connected above 274 V rms a.c.</p> <p>Fuse protected (600V a.c. 50KA rated)</p> <p>Device will be damaged if applied voltage is >440 V rms a.c.</p> <p>Consumption– 110 ma when device is powered and not testing. 11A (pulsed) When test is being carried out.</p> <p>Overvoltage rating - CAT IV 440V rms a.c.</p>
	<p>S and S input (Sensing inputs)</p>	<p>30 V max measuring capability.</p> <p>Input can withstand inadvertent connection to 240 V or 415 V.</p> <p>Fuse protected (700V a.c. 50KA rated)</p> <p>Device will be damaged if applied voltage is >440 V rms a.c.</p> <p>Overvoltage rating - CAT IV 440V rms a.c.</p>

Measuring resolution		Distance given to nearest metre.
Environmental	Working temperature	-20 ⁰ C to 50 ⁰ C
	Storage temperature	-30 ⁰ C to 80 ⁰ C
	Working humidity	Max 90%
	Altitude	Up to 2000M
Display		800x480 pixel TFT LCD resistive touchscreen with LED backlight
IP rating		IP67 (lid closed) IP54 (lid open)
Dimensions		391 x 310 x 173mm
Weight		4Kg
Safety		EN 61010:2010 + A1:2019
EMC		EN 61326-1:2021 (Group 1 Class A) EN 61000-3-2:2019 EN 61000-3-3:2013 + A1:2019 Caution: This equipment is not intended for use in residential environments and may not provide adequate protection to radio reception in such environments.

Accessories

Provided with the fault locator are 4 x 1.5m 1000v CATIV fused test leads with 3 x crocodile clips and 1 x grabber clip. Also this user manual.

Maintenance

The device contains no user serviceable parts, apart from the test leads safety fuses.



Ensure all test leads are disconnected from any live network before attempting to check or replace the fuses.



Do not remove front cover due to risk of electric shock.

If the device is not working correctly for any reason, the device should be sent to B&W technologies for repair.

It is recommend that an annual calibration and maintenance is carried out to maintain accuracy of the device, this service can be carried out by B&W technologies.

B&W Technologies Ltd

Info@bwtechnologiesltd.co.uk