

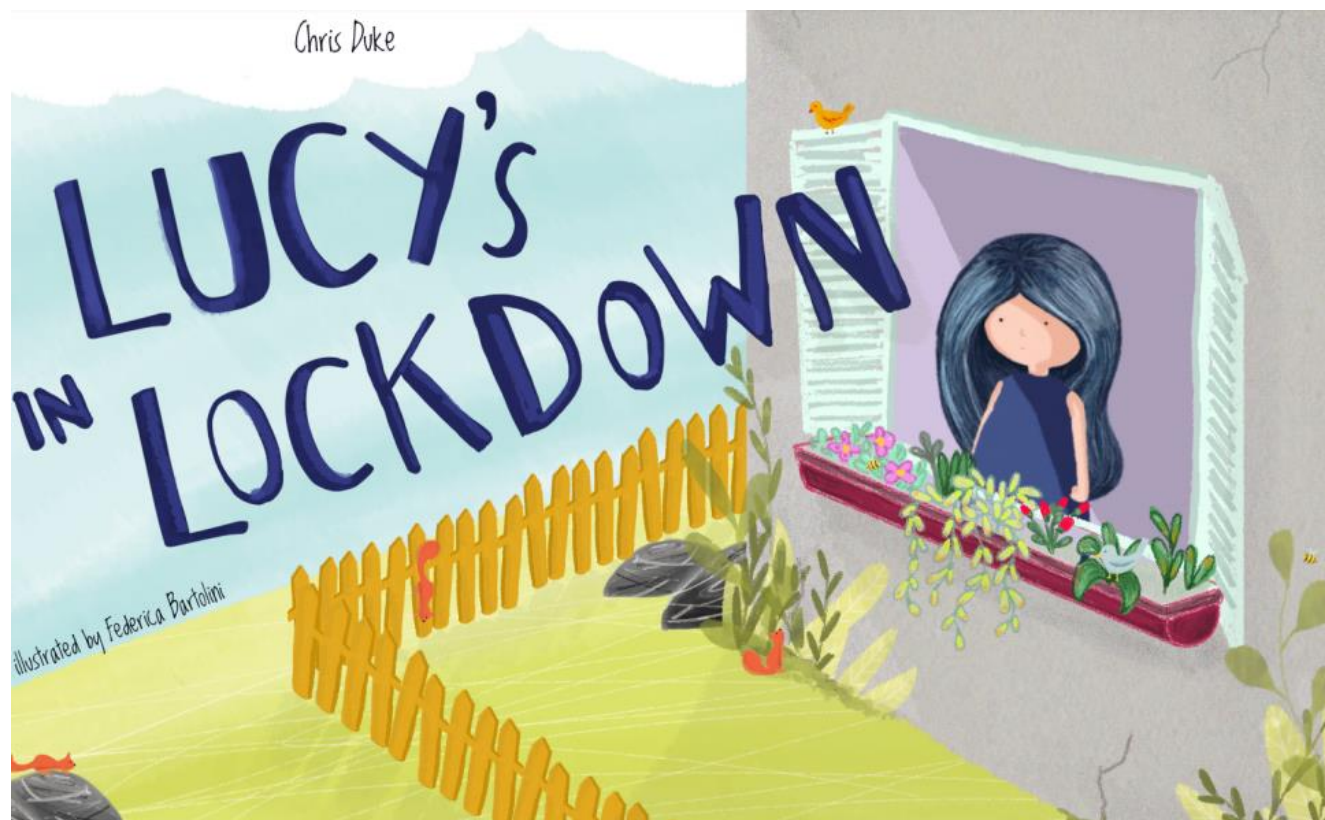

Year 2 Home Learning Pack.

(24.6.20)

Wellbeing and reading comprehension book:



Lucy Pear's hair has turned dark **BLUE** today,

All she wants to do is go out and play.

She's **SAD**, **ANGRY**, and doesn't understand

Everyone's home, in the whole entire land.



She has to stay home,
and not go to school -

Mum tries to teach

while Dad potters with tools.



It's so frustrating being home all day,
But it's to make the virus go away.

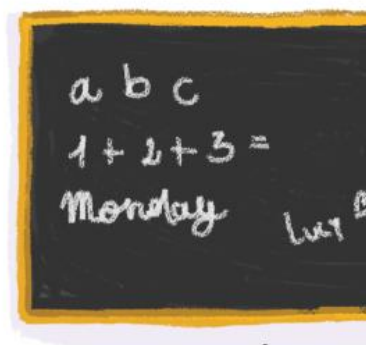

Brad is annoying and is ALWAYS there.
He noticed the change to red in her hair.



She looks out and sees the postie go by;
Her hair turns green, and she understands why.



She looks through the window, gives him a smirk;
She knows he is out there, having to work.
She can't help feel jealous, angry and sad,
And even, sometimes, a little bit glad.

"Thank goodness for tech", she thinks to herself.
A video chat is good for her health! 
Her phone rings, and she sees Maxi Bear's face;
He knows what to say; the same in this case.

"It's fine to feel these feelings. I do too.
It's important to know, it's not just you;
The world is going through this together.
Remember that it won't last forever.

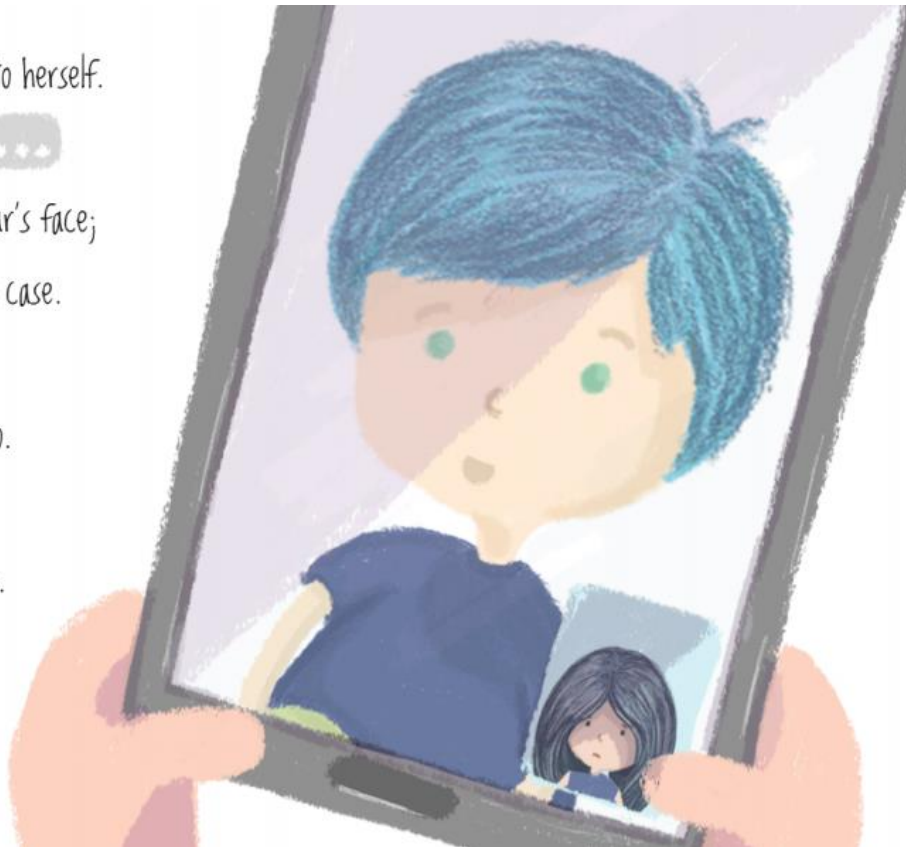

Your mum, your dad, and your bother, Brad, too, They're all feeling the same: RED, or GREEN or BLUE.
Don't bottle them up, but always show it, You'll be back to school before you know it.



And remember, Lucy, I'm always here,
Although not in person,
please do not fear.

And please don't forget what I always say:

"IT'S OK. SOMETIMES
TO HAVE A BLUE DAY"



Wellbeing: Draw what your hair would look like in lockdown.

Remember the colour you choose is based on the emotions you are feeling.

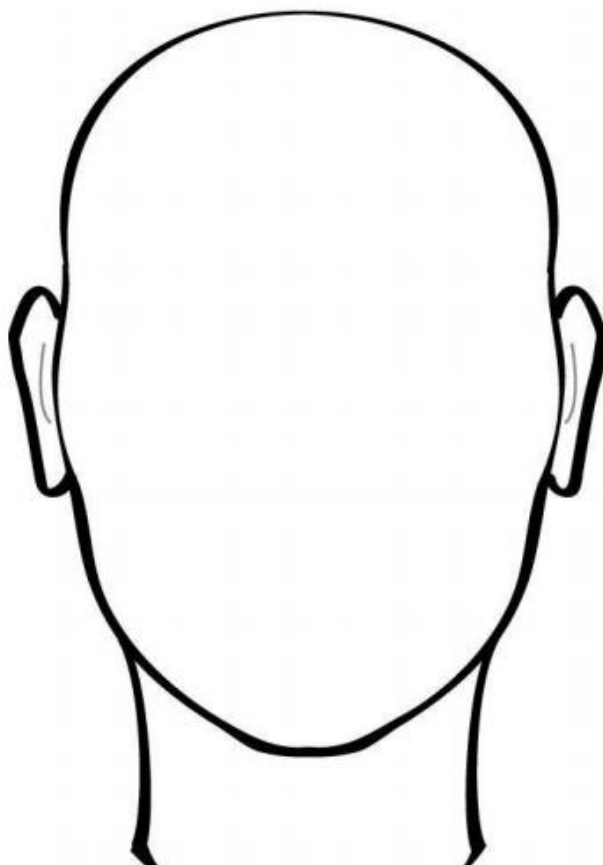

Explain why your hair is this colour:

My hair is _____ because _____



Reading: Comprehension.

Read the story called 'Lucy's in Lockdown' and answer the questions below.

Inference:

1. Why is Lucy's hair blue?

2. Why do they have to stay at home?

3. Why is Mum teaching her?

4. Why does Lucy's hair change to red?

5. Why does her hair go green when she sees the postman?

6. Why is she thankful for technology?

Maths: Measure the mass of objects.

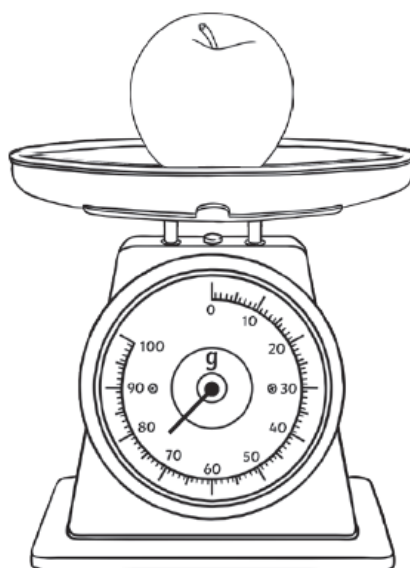
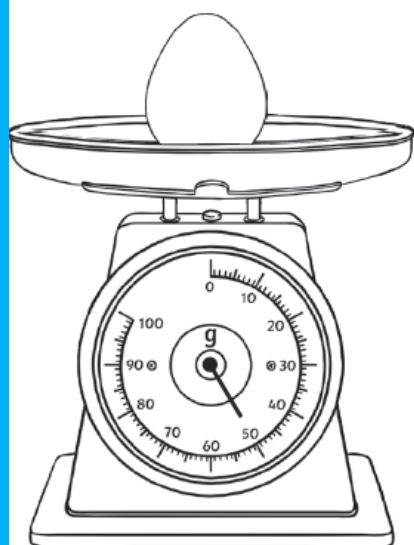
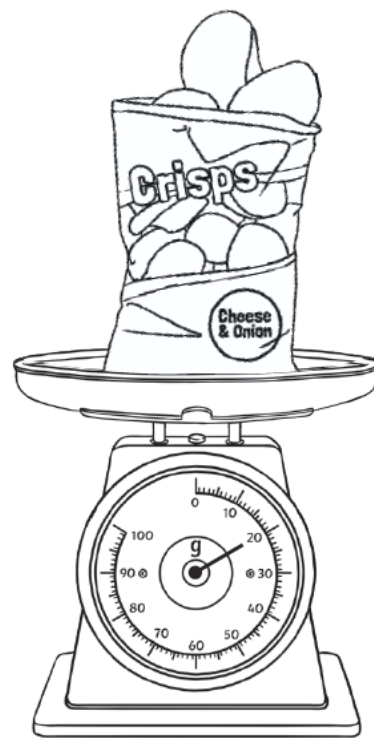
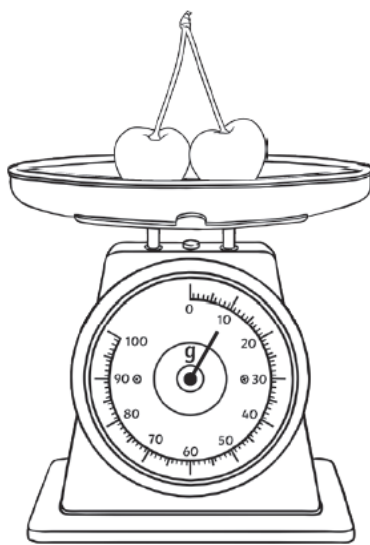
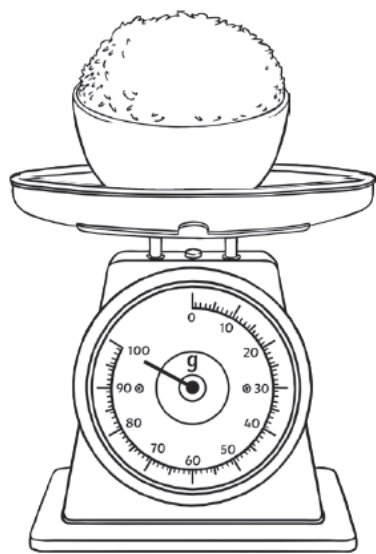

The scale shows 1 Kilogram, each large division is 100 grams and each small division is 20 grams.

Write in the reading for each of the arrows.

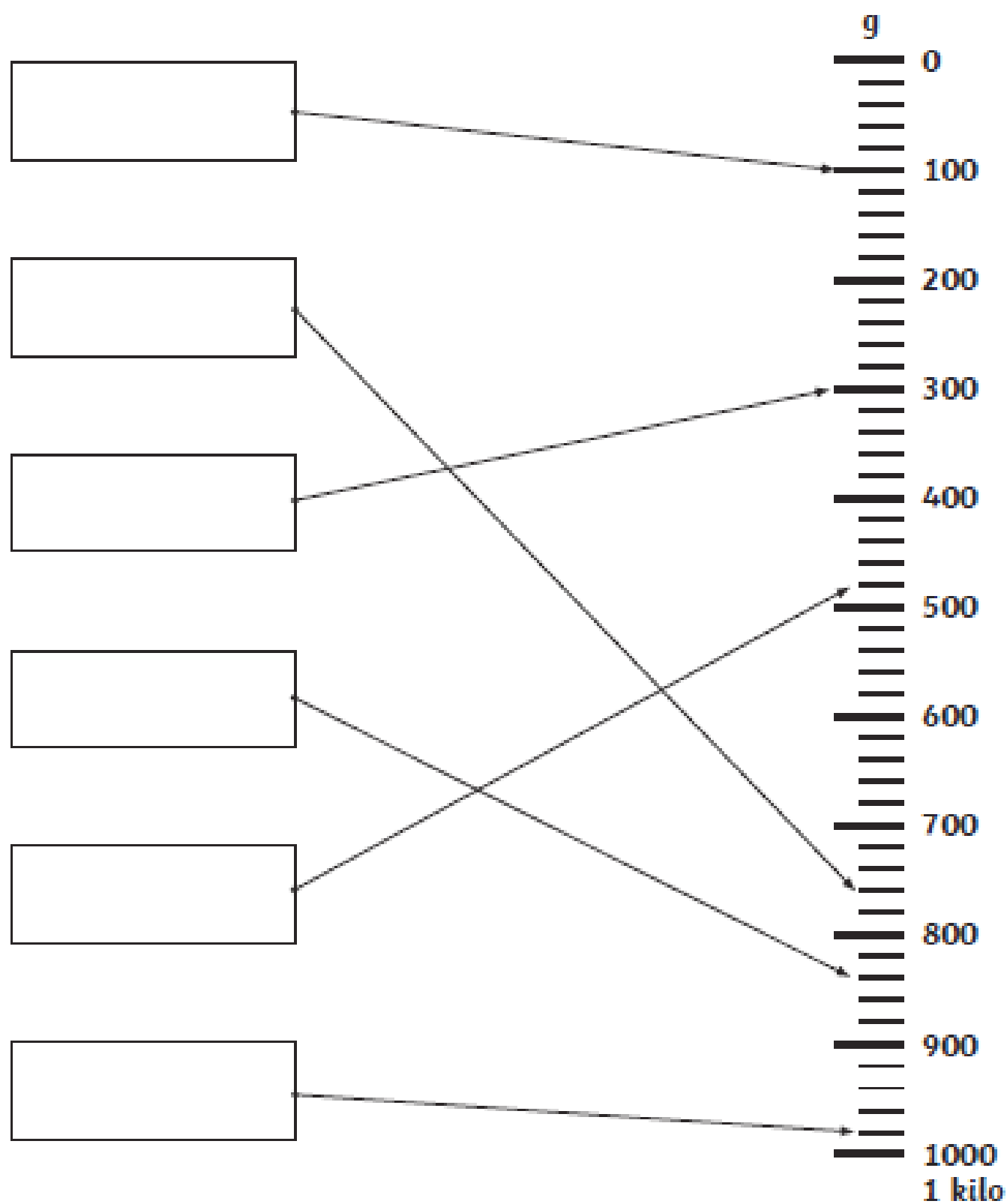



Writing: Conjunctions.

Conjunctions are words that are used to connect clauses or sentences or to coordinate words in the same clause. Examples are: *and, because, that, if, so, but, when, or*.

Write sentences using conjunctions to describe the picture below. Write about: what they are doing, how they feel, what they have, what they look like and where they are going.



Finish the sentences:

1. The witch has a black hat and _____

2. The witch has a wand because _____

3. The witch has a brown broom that _____

4. The dog is happy when _____

Add conjunctions and finish the sentences:

1. The small cat has big eyes _____

2. They have a black cauldron _____

3. They are travelling through the sky on a broom _____

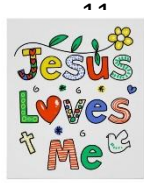
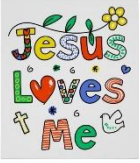

RE: Be more like Jesus!

Jesus is loving, caring and kind. Jesus shows his love for us in many ways. How can you show your love?

Write a Litany sharing how to show love to others.



Jesus loves me and he knows me.

Show your love for others by _____

Jesus loves me and he knows me.

Show you care for others by _____

Jesus loves me and he knows me.

Show you are there for others by _____

Jesus loves me and he knows me.

Show your love for others by _____

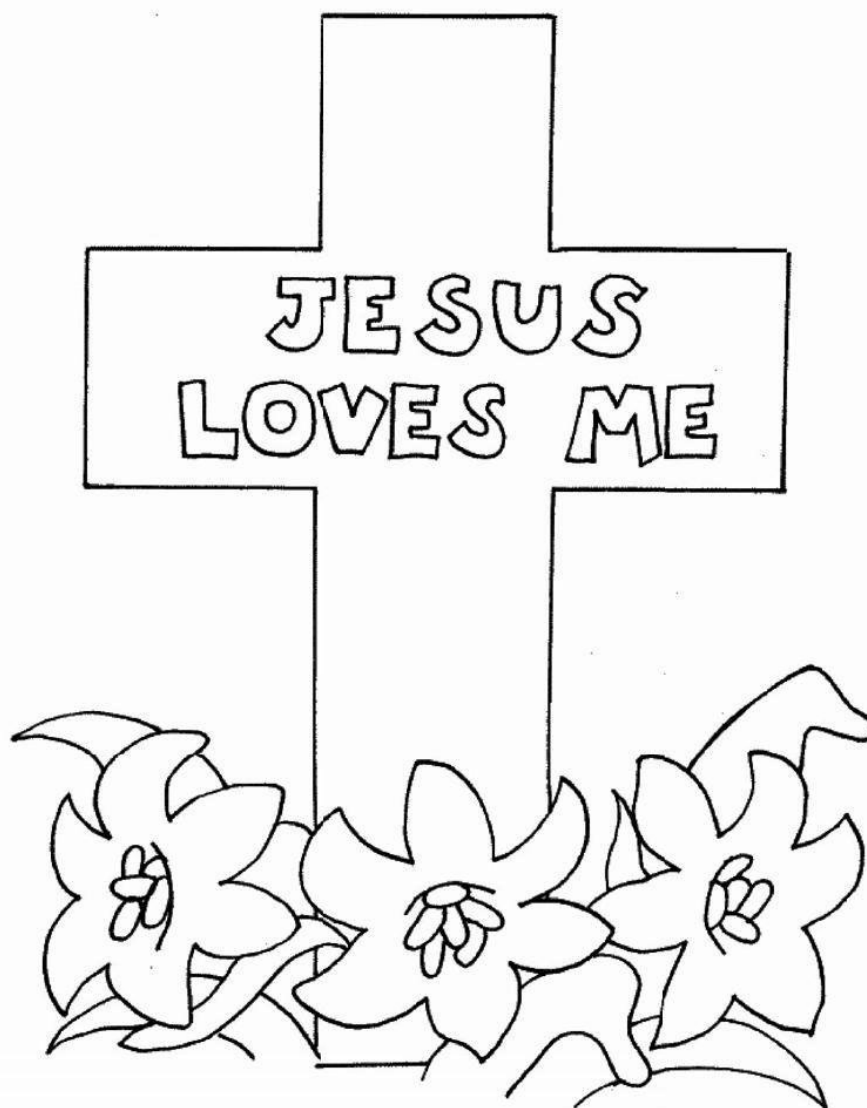

Art and DT: Toilet/kitchen roll crafts.

Using toilet or kitchen roll holders, paint and other arts and crafts resources, create and decorate several different animals, aliens and/or characters.

Use the examples below as inspiration or create your own designs.

Tutorials and more examples:

<https://www.youtube.com/watch?v=l8WygK8pTkc>

