

Supporting Information

Confined 1D Propulsion of Metallodielectric Janus Micromotors on Microelectrodes Under Alternating Current Electric Fields

Liangliang Zhang,^{†@} Zuyao Xiao,^{†@} Xi Chen,[†] Jingyuan Chen[†] and Wei Wang^{†#,}*

[†]School of Materials Science and Engineering, Harbin Institute of Technology (Shenzhen), Shenzhen, Guangdong 518055, China

[#]IBS Center for Soft and Living Matter, Institute of Basic Science, Ulsan 44919, Republic of Korea

[@] equal contributions

^{*}E-mail: weiwangsz@hit.edu.cn

Table of Contents

1. Experimental setup of SiO ₂ -Ti particles under AC electric fields.....	3
2. Simulation details	3
3. Flow profile of the electroosmotic flow	6
4. Microelectrodes designs	6
5. Supporting videos	7

1. Experimental setup of SiO₂-Ti particles under AC electric fields

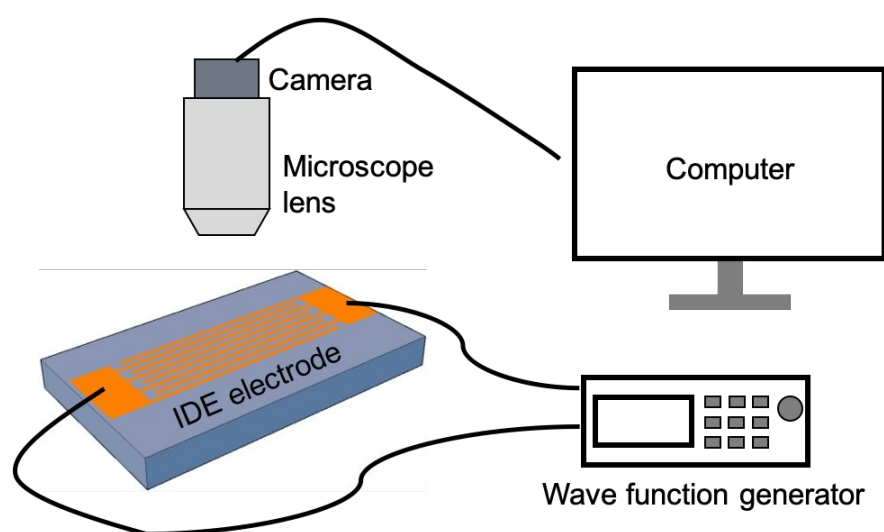

Figure S1 Schematic of experimental setup for a typical experiment.

In a typical experiment, the two large electrode pads of interdigitated microelectrodes (IDEs) are connected to the two output poles of a function generator, which outputs square waves of a particle voltage and frequency. IDEs are mounted on an upright microscope, which has a CCD or CMOS camera connected to a computer that stores the video.

2. Simulation details

Our numerical model was implemented in COMSOL Multiphysics package (version 5.2a). Based on the setup of our experiment, the IDE was placed between deionized water and a glass slide. Consequently, we built two cuboids, which are denoted as the deionized water and glass slide, respectively (Fig. S2).

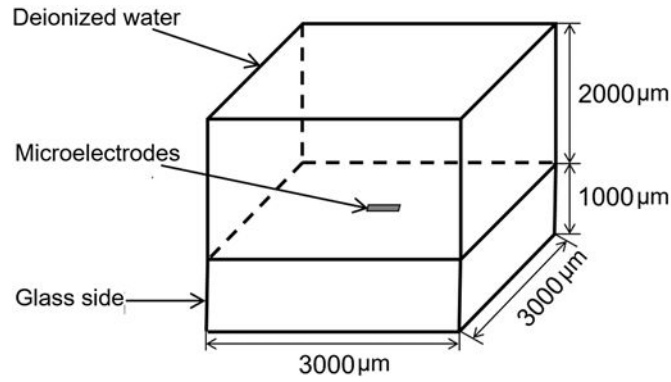

Figure S2 Geometric model of surrounding around microelectrodes

Fig. S3 shows the constructed 3D pattern and specific parameters in the model.

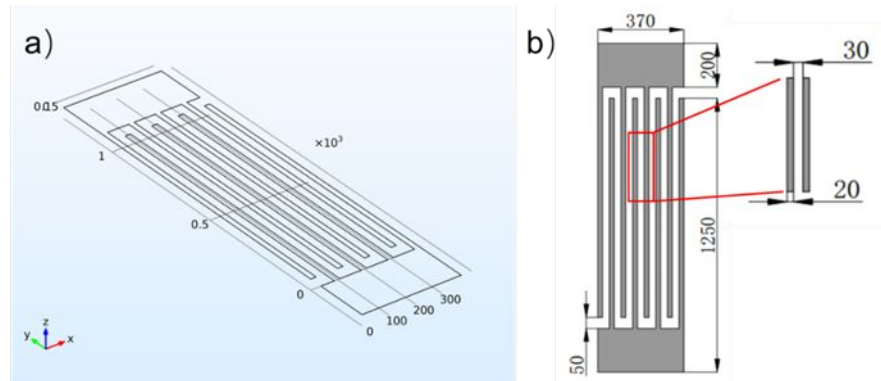

Figure S3 (a) 3D pattern of IDE electrodes (unit: mm); (b) specific parameters of IDE electrodes (unit: μm).

The electrostatic module in COMSOL were used, and the calculated domain is governed by the follow equations: $\nabla \cdot D = \rho_v$, $E = -\nabla V$, where D is electric field flux density, ρ_v is space charge density, E is the electric filed, ∇V is the electric field potential. According to the mechanism of ICEP, speed of spherical Janus particle is strongly dependent on surrounding electric field. Therefore, we used COMSOL to simulate the electric field around the microelectrodes. The simulated electric potential and electric field at y-z cross section of IDE is presented in Fig. S4.

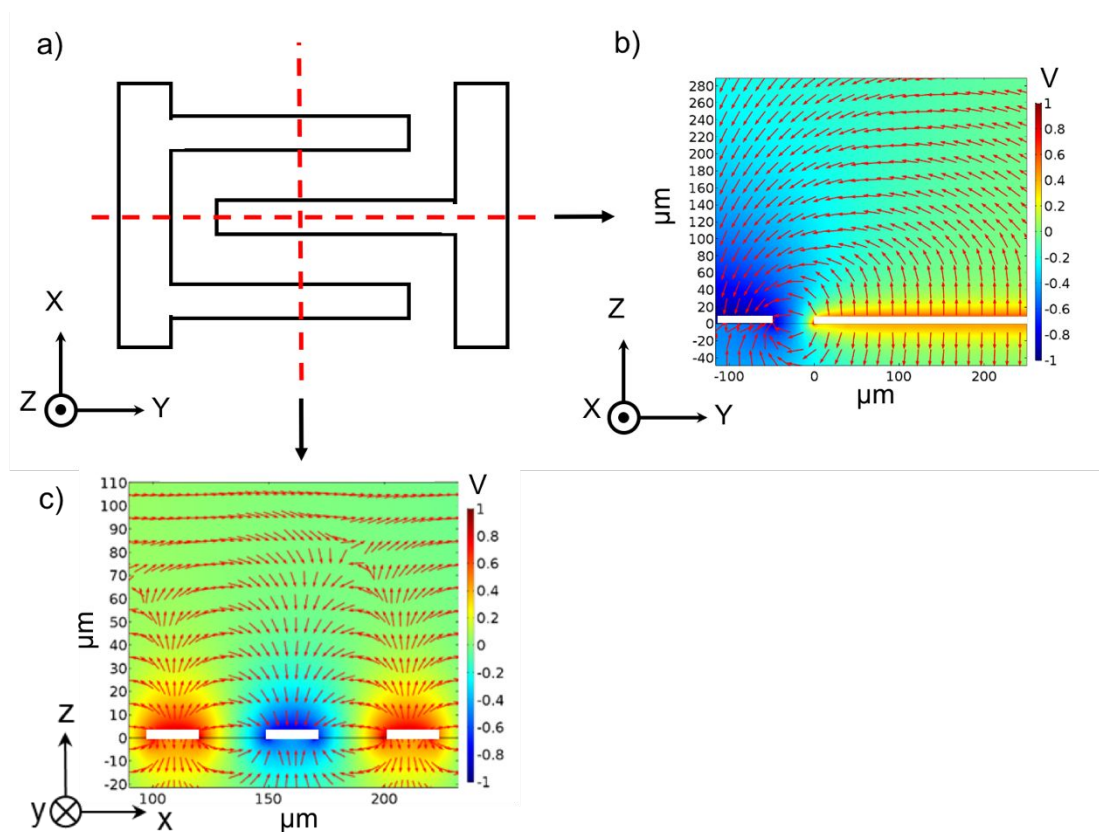

Figure S4 (a) Top view of IDE with cut lines corresponding to b and c. (b, c) Simulated electric potential (color-coded, unit: V) and electric field (red arrows) distribution at y-z cross section (b) and x-z cross section (c). These two electrodes carried 1 and -1 volt, respectively. The sizes of arrows are not correlated with the strength of electric fields.

Figure S4 clearly shows that the electric field strength varies along the Z direction as we move away from the electrode surface. In this simulation, we take the electric field intensity at a distance of $1.7 \mu\text{m}$ from the electrode surface as the representative electric field value a Janus particle experiences (radius $1.5 \mu\text{m}$ plus a gap of 200 nm).

Fig. S5b shows the electric field intensity along the length of an electrode (in the y direction) at different applied electric voltages. The results show that the electric field is for the large part uniform along the electrode, except for a sharp rise near its closure, and a slow decay near an electrode opening.

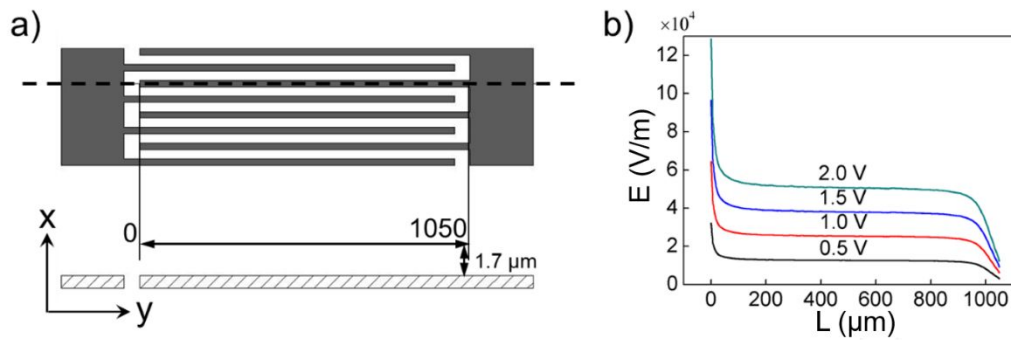

Figure S5 (a) The diagram of electrode in the y-axis direction. Y-axis coordinate is displayed; (b) The Z component of the electric field intensity (E_z) along the electrode at different electric voltages (V).

3. Flow profile of the electroosmotic flow

To quantitatively describe the electroosmotic flow acting on an incoming Janus micromotor moving toward the electrode end, we have tracked the migration of fluorescent polystyrene microspheres ($2\ \mu\text{m}$) under the influence of this flow. Results are shown in Fig. S6. Experiments were carried out with electrodes of $20\ \mu\text{m}$ in width, gaps of $40\ \mu\text{m}$ in width, voltage of 2V and AC frequency of 15 kHz. Results in Fig. S6c are in qualitative agreement with previously published literature values.¹

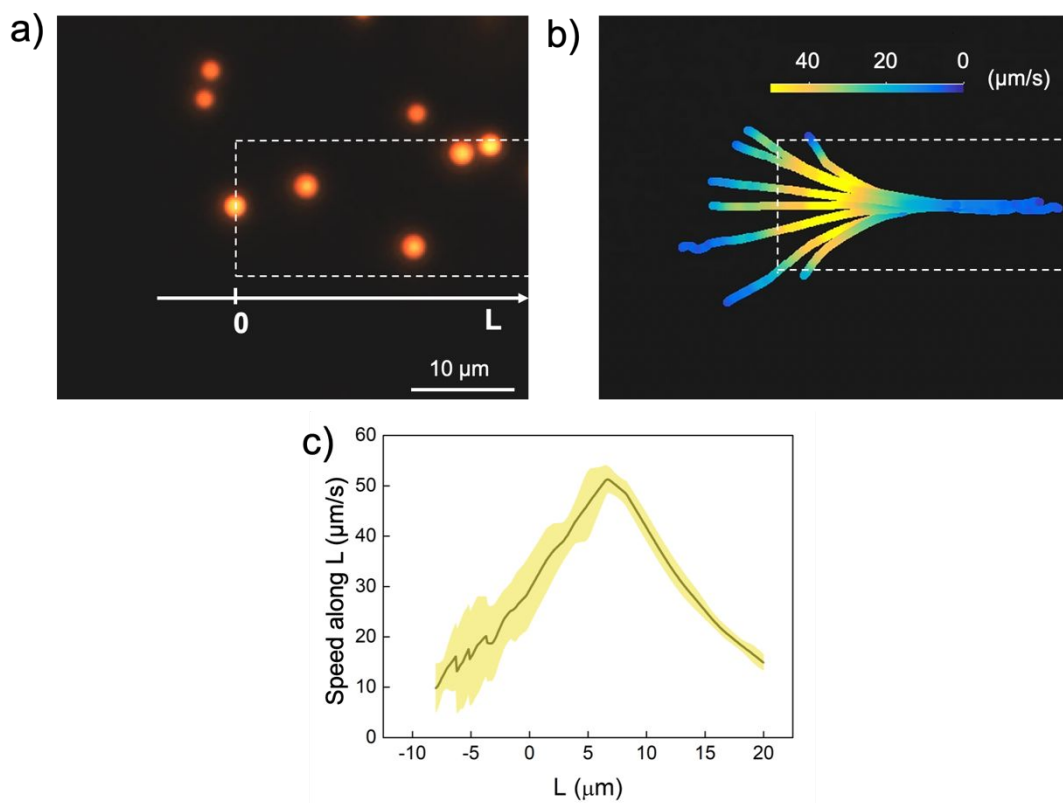

Figure S6 Tracking the electroosmotic transport of microparticles near electrode ends. a) Fluorescent optical micrographs of a few 2 μm PS microspheres. The location of the electrode (not fluorescent) is labeled with dashed lines. b) Trajectories of a few PS particles being transported by the electroosmotic flow, with their instantaneous speeds labeled in colors. c) Average speeds of the PS particles in b) along the direction of L (labeled in a). Yellow shades represent their standard deviation.

4. Microelectrodes designs

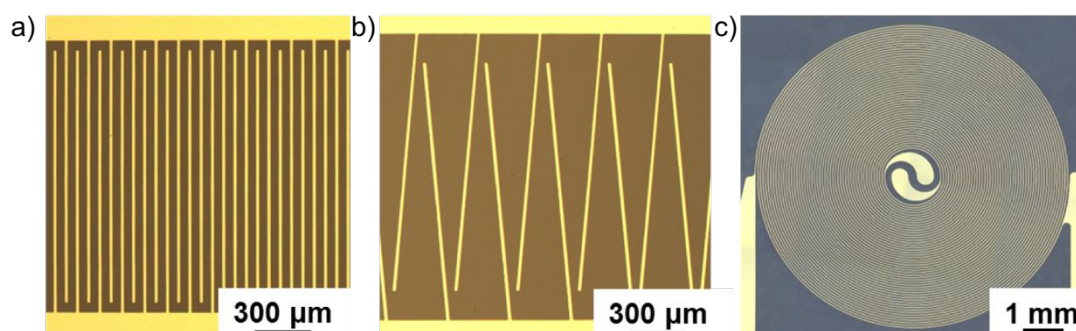

Figure S7 Three designs of microelectrodes used in our experiments. a) Typical

parallel interdigitated microelectrodes used throughout the manuscript. b) Interdigitated microelectrodes with a small offset angle (5°). c) Spiral microelectrodes with electrodes and gaps both of $20\ \mu\text{m}$ in width.

5. Supporting videos

Video S1 Single particle dynamics of SiO_2 -Ti Janus particles on interdigitated microelectrodes. The electric field is turned on roughly at $\sim 00:03$. Upon turning on the AC field, many Janus particles emerged from the dark gap and migrated to the center of the electrode where they move along a 1D track but fluctuate.

Video S2 Janus particles are convected upward at the center of an electrode by the converging electroosmotic flow coming from the sides. The focus is moved upward to see the convection at around $00:08$.

Video S3 Two SiO_2 -Ti Particles moving in opposite directions. This video is sped up 3 times.

Video S4 A line of Janus particles moving in the same direction.

Video S5 A chaotic group of Janus particles.

Video S6 A Janus particle making U-turns at the closure of a finger electrode (located at the bottom of the video). This video is sped up 3 times.

Video S7 Janus particle slowing down at the open end of an electrode. This video is sped up 3 times.

Video S8 Accumulation of a large number of particles at the openings of finger electrodes. This video is sped up 2 times.

Video S9 Accumulated Janus particles on the large gold pad can be activated by switching on the vertical electric field (see main text for electrode configuration). They move and assemble into labyrinth patterns. The vertical electric field is switched on ~ 1 -2 seconds into the video.

Video S10 An active Janus micromotor ploughs through inert SiO_2 microspheres accumulated at the electrode center. Very weak inter-particle interactions are seen.

References

1. Green, N. G.; Ramos, A.; González, A.; Morgan, H.; Castellanos, A., Fluid Flow Induced by Nonuniform AC Electric Fields in Electrolytes on Microelectrodes. I. Experimental Measurements. *Phys. Rev. E* 2000, 61, 4011-4018.