

Supporting Information (SI)

Reducing ammonia emissions from dairy cattle production via cost-effective manure management techniques in China

Nannan Zhang^{1,2,†}, Zhaohai Bai^{1,†}, Wilfried Winiwarter^{3,4}, Stewart Ledgard⁵, Jiafa Luo⁵,
Juan Liu^{1,2}, Yongqing Guo^{1,6}, Lin Ma^{1,*}

¹ Key Laboratory of Agricultural Water Resource, Hebei Key Laboratory of Soil Ecology, Center for Agricultural Resources Research, Institute of Genetic and Developmental Biology, Chinese Academy of Sciences, 286 Huaizhong Road, Shijiazhuang 050021, Hebei, China;

² University of Chinese Academy of Sciences, 19 A Yuquan Road, Shijingshan District, Beijing 100049, China

³ International Institute for Applied Systems Analysis (IIASA), Schlossplatz 1, A-2361 Laxenburg, Austria

⁴ The institute of Environmental Engineering, University of Zielona Gora, Licealna 9, 65-417 Zielona Gora, Poland

⁵ AgResearch Limited, Ruakura Research Centre, Private Bag 3123, Hamilton 3240, New Zealand

⁶ College of Animal Science, South China Agricultural University, Guangzhou 510642, China

† These authors contributed to this paper equally.

22 * Corresponding author: email, malin1979@sjziam.ac.cn, phone +8618503216030

23 **Summary:** Supporting information contains 32 pages, 12 figures and 7 tables.

24

25	Contents	
26	1. Measurement of ammonia emission abatement efficiency from diet manipulation ...	S4
27	2. Measurement of ammonia emission abatement efficiency from acidification in	
28	housing	S5
29	3. Measurement of ammonia emission abatement efficiency from covering and	
30	compaction of manure during storage	S6
31	4. Technical implementation of the abatement options.....	S7
32	5. Calculation of reduction efficiency	S9
33	6. Uncertainty and sensitivity analysis	S9
34	References	S32
35		
36		

37 In this study, reduction efficiencies of the NH₃ mitigation measures were evaluated
38 using an incubation method, which was used to represent the upper limits of the optimal
39 NH₃ mitigation potentials. The trials were conducted in the laboratory at a temperature
40 of 15-20°C. All selected mitigation options are shown in Table S6 (note: sequence of
41 tables as mentioned in the main text). Excreta from cows from the diet manipulation
42 treatments was derived from combination of urine and faeces collected from cows fed
43 with a standard diet (17% crude protein [CP]) or a low CP diet (15% CP), which are
44 detailed in the following section. Slurry used for testing acidification in housing was
45 collected directly from the floor of a dairy house, while slurry used for the storage test
46 was collected from manure channels that were connected to dairy houses. Both solid
47 and liquid manures used for the storage test were collected after manure was separated
48 using a screw-press separator. Thus, three manure types (slurry, solid and liquid
49 manure) were evaluated for the storage stage. Properties of manures used in this study
50 are shown in Table S7.

51

52 **1. Measurement of ammonia emission abatement efficiency from diet manipulation**

53 There were two dietary treatments in the present study; a standard diet (17% CP) and a
54 low CP diet (15% CP). Ingredients of standard diet contained oat hay, 10.65% DM;
55 alfalfa hay, 11.91% DM; whole corn silage, 28.02% DM; concentrate feed, 19.04%
56 DM; steam-flaked corn, 13.55% DM; ground corn, 7.12% DM; soybean meal, 0.46%
57 DM; whole cottonseed, 3.22% DM; beet pulp, 5.51% DM; mono-dicalcium phosphate,

58 0.52% DM. Ingredients of low CP diet contained: Oat hay, 10.65% DM; alfalfa hay,
59 11.91% DM; whole corn silage, 28.02% DM; concentrate feed, 19.04% DM;
60 steam-flaked corn, 8.5% DM; ground corn, 7.12% DM; soybean meal, 3.22% DM; corn
61 gluten meal, 2.3% DM; whole cottonseed, 3.22% DM; beet pulp, 5.51% DM;
62 mono-dicalcium phosphate, 0.52% DM. Urine and faeces were collected separately
63 under the tail of 4 lactating cows fed the dietary treatments, 2 cows for each respective
64 diets. Samples were collected individually over four continuous days and stored in
65 plastic containers at 4°C to limit potential N loss during storage. Separate urine and
66 faeces samples from each dairy cow were bulked for the four collection days.
67 Immediately before the start of the experiment, 100 ml of urine and 150 g of faeces¹
68 from the same dairy cow were mixed in a plastic chamber with a height of 9.3 cm and
69 diameter of 9.2 cm. For each dairy cow, three replicates of NH₃ emission measurements
70 were made over five days using a static chamber.^{2,3}

71

72 Gas emission rates were measured every six hours during the first day, every eight
73 hours during the second day, and every twelve hours during the last three days. For each
74 measurement, the concentration of NH₃ inside the chambers was recorded 3 times at an
75 interval of 2 min between two adjacent measurement occasions using a Multi-Gas
76 Monitor INNOVA 1412i. The difference in NH₃ gas concentration during the last two
77 adjacent measurements was used to calculate the gas emission flux.

78

79 **2. Measurement of ammonia emission abatement efficiency from acidification in**
80 **housing**

81 For simulation of housing practice, we assumed that the dairy building has a slatted
82 floor. Slurry was directly collected from dairy housing, and moved to a box simulating a
83 pit in a layer of 5 cm thick. Length, width and height of the simulated slatted pit were
84 25.5, 37 and 22 cm, respectively. After the addition of manure into the pit, sulfuric acid
85 (H_2SO_4), diluted 1: 100 with water, was sprayed evenly on to the manure surface to add
86 a layer of about 3 mm. Amount of acid was small compared to the volume of manure,
87 and it was expected that it had no influence on quality of slurry and bio-availability of N
88 in the manure.

89
90 The ventilated chamber method was used to quantify NH_3 emission five times:¹ at the
91 beginning, and at 6, 12, 18 and 24 h after application of the acid. Ventilation rate was
92 0.2 head space exchanges min^{-1} which simulated the air ventilation in the dairy
93 building.¹ NH_3 in the gas removed from the chamber was absorbed in 2% boric acid,
94 which was subsequently titrated by standard H_2SO_4 solution. NH_3 emission was
95 calculated from the consumption of H_2SO_4 .

96
97 **3. Measurement of ammonia emission abatement efficiency from covering and**
98 **compaction of manure during storage**

99 During storage, we applied vermiculite cover or acidified vermiculite cover layers, each

100 with a 6 cm thickness, to the surface of slurry or surface of liquid manure. Acidified
101 vermiculite cover was created by mixing lactic acid and vermiculite at a volume ratio of
102 1:5. The diameter and height of the containers used were 20 and 35 cm, respectively.
103 The abatement measures used for solid manure were a plastic film cover and/or
104 compaction. The type of container for solid manure storage was the same as for slurry
105 and liquid manure. The original height of solid manure was 20 cm. Compaction of solid
106 manure halved the volume of manure.

107

108 Storage of slurry, liquid manure and solid manure lasted for 15 days, and gas emission
109 was measured at 1, 2, 3, 4, 7, 11 and 15 days after application of the treatments. During
110 storage, NH₃ emission was measured using the ventilated chamber method⁴. Air
111 ventilation rate was 20 head space exchanges min⁻¹, which was used to measure the
112 maximum potential NH₃ emission. NH₃ in the gas removed from the chamber was
113 absorbed in 2% boric acid, titrated with standard H₂SO₄ and calculated as for the
114 acidification study described above.

115

116 **4. Technical implementation of the abatement options**

117 For cow housing, we determined the effects of the acidification treatment for manure
118 under a slatted floor (Figure 1a). To estimate the cost involving the acidification
119 measures, we made the following general assumptions about dairy houses, acidification
120 system and application: 1) each dairy building has two stirring systems, which were

121 used to dilute H_2SO_4 100 times, and four sprinkler systems, which were used to apply
122 the diluted H_2SO_4 to the surface of slurry under the slatted floor; 2) each sprinkler
123 system included 50 nozzles, 110 m pipe and one pump; and 3) three L of tap water m^{-2}
124 manure was used to clean the spraying system after each operation.

125

126 For the covered system, a cover was assumed to be applied across the stored slurry and
127 liquid manure (Figures 1b and S11). The equipment used here was a mixer and a system
128 consisting of a U-spiral conveyor with mesh on the bottom and tracks, installed on the
129 edge of the tank. Movement of the conveyor along the tracks at a proper speed could
130 distribute the vermiculite cover or the acidified vermiculite cover to the surface of
131 manure in the store tank. For the acidified vermiculite cover treatment, a mixer was
132 used for mixing lactic acid with vermiculite. As size of tank influenced the costs of the
133 equipment and operation, we assumed that the tank used for storage was 10 m wide
134 with a maximum depth of 4.5 m for stored slurry and liquid manure, based on the
135 general practice on the dairy farm.

136

137 Plastic film cover was placed on the top edge of the store facility (Figure 1c). As
138 manure was added to the facility, the plastic film was immediately used to cover it
139 mainly through a manual operation, and the lifetime of the plastic film used was
140 assumed to be 1 year. A road roller was used for compacting the solid manure (Figure
141 1c). As for the assumption presented above, the depth of stored solid manure was 1.5 m

142 while the depth of solid manure added per day was 0.15 m. The road roller was used to
143 compact the new added manure on the top of the manure store for three times in
144 succession each time.

145

146 **5. Calculation of reduction efficiency**

147 Abatement efficiencies of the test options were calculated based on differences in total
148 NH₃ emission from the tested options and the controls according to eq S1:

$$149 \text{ RE} = \frac{f_{\text{control}} - f_{\text{abatement}}}{f_{\text{control}}} \quad (\text{S1})$$

150 Where RE is defined as the reduction efficiency of abatement options directly measured
151 from the experiment; f_{control} and $f_{\text{abatement}}$ are total emissions for the nil-abatement and
152 abatement measures, respectively.

153

154 **6. Uncertainty and sensitivity analysis**

155 Many factors influenced estimation of NH₃ emission, abatement potential and net
156 economic benefit, such as animal numbers, emission factors, NH₃ abatement
157 efficiencies and the price of materials used for technical implementation of the different
158 options. Using the Monte Carlo simulation, uncertainties of baseline NH₃ emission,
159 reduction potential and net economic benefit of the selected abatement options were
160 assessed and are shown in Figures S2 and S6. Abatement options using the low CP diet,
161 acidification of surface manure during housing and solid manure compaction
162 (representing the most economic benefit, the highest-reduction and the lowest-reduction

163 abatement options, respectively) were selected to conduct the sensitivity analysis of the
164 net economic benefit for the three components (i.e. total technical implementation cost,
165 total mineral fertilizer cost saving and health damage cost saving) using both European
166 health damage data set and decreased health damage data set (Figure S12). Based on the
167 decreased health damage cost, the net economic benefit of low protein feed was more
168 sensitive to total implementation cost and health damage cost saving than total mineral
169 fertilizer cost saving, which was due to the low proportion of mineral fertilizer cost
170 saving related to the net economic benefit. Based on the “European” health damage
171 cost, the net economic benefit became more sensitive to the health damage cost saving.

172

173 **Table S1** Ammonia emission abatement efficiencies from the test abatement options

Stage	Manure system	Abatement option ^a	Reduction efficiency, %	
			Mean	Range
Feeding	Mixed excreta	Low protein feed	24	13-38
Housing		Acidification	98	97-98
Storage	Slurry	Cover	81	75-86
		Cover and acid	94	93-94
	Liquid manure	Cover	75	74-77
		Cover and acid	86	85-88
	Solid manure	Plastic film cover	71	66-75
		Manure compaction	2.7	1.5-7.2
		Manure compaction & cover (liquid) ^b	37	31-37
		Manure compaction & cover and acid (liquid) ^c	42	36-42

174 ^a See Table S6 for details of abatement options.

175 ^b Manure compaction & cover (liquid) refers to solid manure compaction and a
 176 vermiculite cover on liquid produced following compaction during storage.

177 ^c Manure compaction & cover and acid (liquid) refers to solid manure compaction and a
 178 vermiculite cover acidified with lactic acid on liquid produced following compaction
 179 during storage.

180 **Table S2** List of parameters used for the calculation of investment cost

			Total cost of investment ^a		Fixed operation	Lifetime of the	Numbers of dairy
			(US\$ system ⁻¹)		rate ^b	equipment	cows
			Mean	s.d. ^c	(%)	(year)	(head)
Acidification system during housing			595	46	4	2	100 ^h
Distribution system	Slurry	Cover ^d	7637	945	4	10	500 ⁱ
		Cover and acid ^e	7637	945	4	10	500 ⁱ
	Liquid manure	Cover ^d	7383	934	4	10	500 ⁱ
		Cover and acid ^e	7383	934	4	10	500 ⁱ
Plastic film cover ^f			- ^j	-	4	1	500 ⁱ
Compaction system ^g			1295	51	4	6	500 ⁱ

181 ^a Total cost of investment includes cost for equipment and installation excluding materials.

182 ^b Fixed operation rate reflects the cost of maintenance, insurance, and administrative overhead of equipment installed on dairy farm.

183 ^c s.d. means the standard deviation.

184 ^d Cover refers to a vermiculite cover on slurry or liquid manure during storage.

185 ^e Cover and acid refers to a vermiculite cover acidified with lactic acid on slurry or liquid manure during storage.

186 ^f Plastic film cover means the plastic film cover on the solid manure separated from slurry, and it can be operated without any equipment.

187 ^g Compaction system means the road roller for solid manure compaction.

188 ^h 100 means that the assumption of one system of corresponding mitigation option was based on 1 animal building housing 100 dairy cows.

189 ⁱ 500 means that the assumption of one system of corresponding mitigation option was based on 1 dairy farm with 500 dairy cows.

190 ^j No equipment was used for the implementation of plastic film cover on solid manure, and labor and plastic film cover were classified to
 191 be the variable operation.

192 **Table S3** List of parameters used for the calculation of variable operation costs

			Labor cost	Energy cost	Price of the material (US\$ m ⁻³) ^a	
			(US\$ cow ⁻¹ yr ⁻¹)	(US\$ cow ⁻¹ yr ⁻¹)	Mean	Standard deviation
Acidification system during housing			0.09	0.02	459	111
Distribution system	Slurry	Cover ^d	0.17	0.01	17	2.5
		Cover and acid ^e	0.74	0.02	302	41
	Liquid manure	Cover ^d	0.09	0.01	17	2.5
		Cover and acid ^e	0.36	0.01	302	41
Plastic film cover ^f			0.00	0.00	0.4	0.08
Compaction ^g			0.55	0.60	-	-
Compaction & cover (liquid) ^h			0.58	0.60	17	2.5
Compaction & cover and acid (liquid) ⁱ			0.65	0.60	302	41

193 Table continued and footnotes on next page.

194 **Table S3** List of parameters used for the calculation of variable operation costs (continued)

	Usage amount of material	Unit of usage amount	Working area of storage facility ^b (m ² cow ⁻¹ yr ⁻¹)		R _f ^c (times yr ⁻¹)
			Mean	Standard deviation	
Acidification system during housing	0.58	ml H ₂ SO ₄ kg ⁻¹ manure		-	365
Distribution Slurry system	Cover ^d	cm thickness	0.66	0.19	6
			0.66	0.19	6
	Cover and acid ^e	cm thickness	0.32	0.09	6
			0.32	0.09	6
Liquid manure	Cover ^d	cm thickness	0.32	0.09	6
Plastic film cover ^f	0.77	m ² cow ⁻¹ yr ⁻¹	0.78	0.09	1
Compaction ^g	-	-		91.9	365
Compaction & cover (liquid) ^h	6	cm	0.09	0.02	6
Compaction & cover and acid (liquid) ⁱ	6	cm	0.09	0.02	6

195 ^a Unit price of plastic film cover is US\$ m⁻².

196 ^b Working area of storage facility for slurry and liquid manure means area of storage place, and working area of storage facility for
197 compaction system means the total area for compaction per year based on assumption of 0.15 m thickness of solid manure added per day,
198 and its uncertainty was derived from the variation of the depth of storage facility.

199 ^c R_f refers to the replacement frequency.

200 ^d Cover refers to a vermiculite cover on slurry or liquid manure during storage.

201 ^e Cover and acid refers to a vermiculite cover acidified with lactic acid on slurry or liquid manure during storage.

202 ^f Plastic film cover refers to a plastic film cover on solid manure during storage. Considering the limited labor time to apply the plastic film
203 cover, no additional staff and salary was assumed.

204 ^g Compaction refers to solid manure compaction. No material is applied to compaction system.

205 ^h Materials applied to compaction & cover (liquid) refers to a vermiculite cover on liquid produced following compaction.

206 ⁱ Materials applied to compaction & cover and acid (liquid) refers to a vermiculite cover acidified with lactic acid on liquid waste produced
207 following compaction.

208 **Table S4** Uncertainty range and probability density function (PDF) of input parameters in the ammonia emission estimation, emission
 209 reduction estimation and cost-benefit analysis.

Item	Uncertainty range ^a	PDF	Reference
Emission estimation:			
Livestock number	±5%	Normal	5, 6
Manure N excretion	±20%	Lognormal	7, 8
N emission factor (NH ₃ , N ₂ O, N ₂ , NO ₃ ⁻)	±33%	Lognormal	7, 9,10
Reduction efficiency	See Table S1	Normal	This study
Cost-benefit analysis:			
Investment price	See Table S2	Normal	Survey ^b
Variable operation cost	See Table S3	Normal	Survey ^b
Urea price	±5%	Normal	Survey ^b
Diesel fuel price	±20%	Normal	Survey ^b
Gasoline fuel price	±20%	Normal	Survey ^b
Diet ingredient price	±5%	Normal	Survey ^b
Depth of manure storage facility (solid manure separated from slurry)	±33%	Normal	Survey ^b
Depth of manure storage facility (slurry and liquid manure separated from slurry)	±11%	Normal	Survey ^b
Animal stock in dairy farm	±70%	Normal	Survey ^b
Population	±5%	Normal	6
Land area	±5%	Normal	6
Fertilizer replacement percentage of retained manure N	±33%	Uniform	Survey ^b

210 ^a When the direct standard deviation is not available, the uncertainty range was assumed to be ±2 standard deviations of the parameter.

211 ^b Survey means that the uncertainty range of the parameters was derived survey data.

212 **Table S5** Health damage cost saving and net economic benefit considering health damage cost saving under selected abatement options for
 213 dairy production in China in 2015. The respective scenarios are described in Section 2.2 in the main text.

	Acidification	Low protein feed	Cover and acid (slurry)	Cover (slurry)	Cover and acid (liquid)	Cover (liquid)
Health damage cost saving (European health data set ^{a)} , million US\$	4474	2816	2036	2019	1355	1185
Net economic benefit (European health data set ^{b)} , million US\$	4315	4383	522	1906	596	1108
Health damage cost saving (Decreased health data set ^{a)} , million US\$	447	282	204	202	136	119
Net economic benefit (Decreased health data set ^{b)} , million US\$	288	1848	-1310	89	-624	41

214 Table continued and footnotes on next page.

215 **Table S5** Health damage cost saving and net economic benefit considering health damage cost saving under selected abatement options for
 216 dairy production in China in 2015. The respective scenarios are described in Section 2.2 in the main text.

	Manure compaction & cover and acid (liquid)	Plastic film cover	Manure compaction & cover (liquid)	Manure compaction
Health damage cost saving (European health data set ^a), million US\$	1736	652	1521	25
Net economic benefit (European health data set ^b), million US\$	752	654	1400	-11
Health damage cost saving (Decreased health data set ^a), million US\$	174	65	152	2.5
Net economic benefit (Decreased health data set ^b), million US\$	-811	67	31	-33

217 ^a European health data set means the health damage cost analysis based on the value of a life year in Europe.^{5, 6, 11}

218 ^b Decreased health data set means the health damage cost analysis based on an adjustment factor for the value of a life year of 10%, which
 219 was used as Chinese situation.^{5, 6, 12}

220 **Table S6** Ammonia emission abatement options

Stage	Manure system	Abatement option	
Feeding	Mixed excreta	Low protein feed	15% ^a compared with 17% ^b diet crude protein
Housing	Slurry	Acidification	Spraying sulfuric acid (H ₂ SO ₄ , diluted 1: 100 with water) to form a layer of 3 mm on manure surface
Storage	Slurry	Cover	Vermiculite cover with a layer of 6 cm on slurry
		Cover and acid	Vermiculite mixed with lactic acid (99%) at a volume ratio of 1:5 with a layer of 6 cm on slurry
	Liquid manure ^c	Cover	Vermiculite cover with a layer of 6 cm on slurry
		Cover and acid	Vermiculite mixed with lactic acid (99%) at a volume ratio of 1:5 with a layer of 6 cm on slurry
Solid manure ^c	Plastic film cover	-	
	Manure compaction	Compaction until the volume of solid manure halved	

221 ^a Ingredients of diet with 15% crude protein.

222 ^b Ingredients of diet with 17% crude protein.

223 ^c Liquid manure and solid manure were separated from slurry with a screw-press separator.

224 **Table S7** Chemical characteristic of manure used in the trials

Parameters ^a	Urine		Faeces		Slurry from	Slurry from	Liquid	Solid
	17% CP ^b	15% CP ^c	17% CP	15% CP	floor	channel	manure	manure
TN, g N kg ⁻¹ manure	11.42±0.02	8.73±2.33	3.96±0.15	3.89±0.26	3.42±0.23	4.36±0.18	2.15±0.20	2.96±0.09
TAN, g N kg ⁻¹ manure	NA	NA	NA	NA	1.24±0.07	2.08±0.05	1.33±0.17	0.45±0.16
W, %	NA	NA	84.02±0.37	82.08±0.53	86.30±0.99	74.42±1.79	93.84±3.19	57.53±0.59
pH	NA	NA	NA	NA	8.26±0.09	8.18±0.21	8.09±0.19	8.61±0.08

225 ^a TN, total N; TAN, total ammoniacal N; W, water content.

226 ^b 17% CP means a standard diet treatment in the diet manipulation trial.

227 ^c 15% CP means a low crude protein diet treatment in the diet manipulation trial.

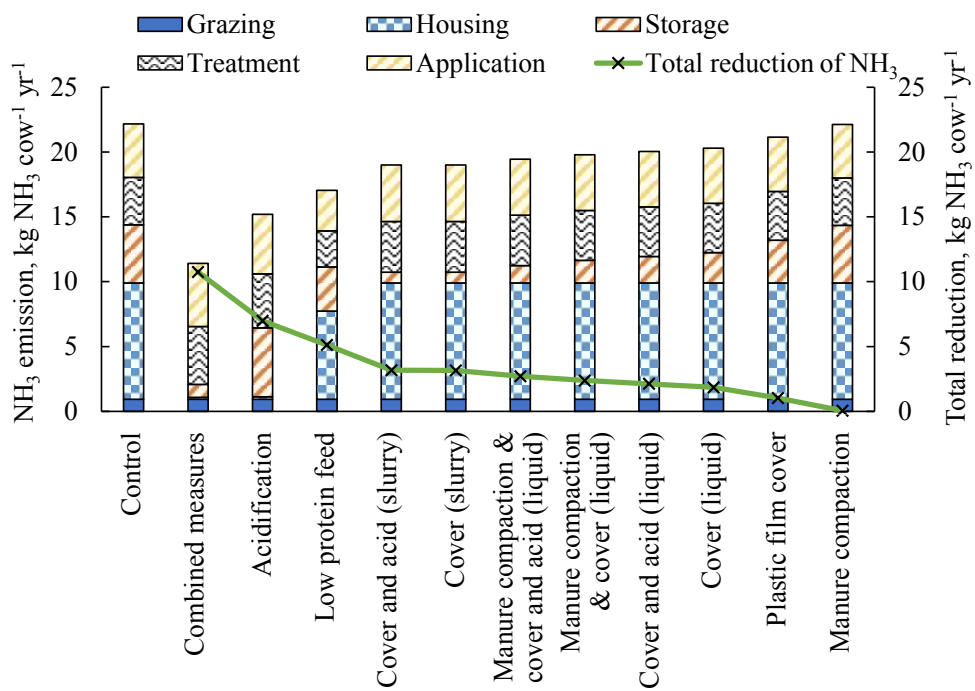

228

229 **Figure S1.** Ammonia emission on animal basis from selected abatement options for dairy
 230 production in China in 2015. The respective scenarios are described in Section 2.2.

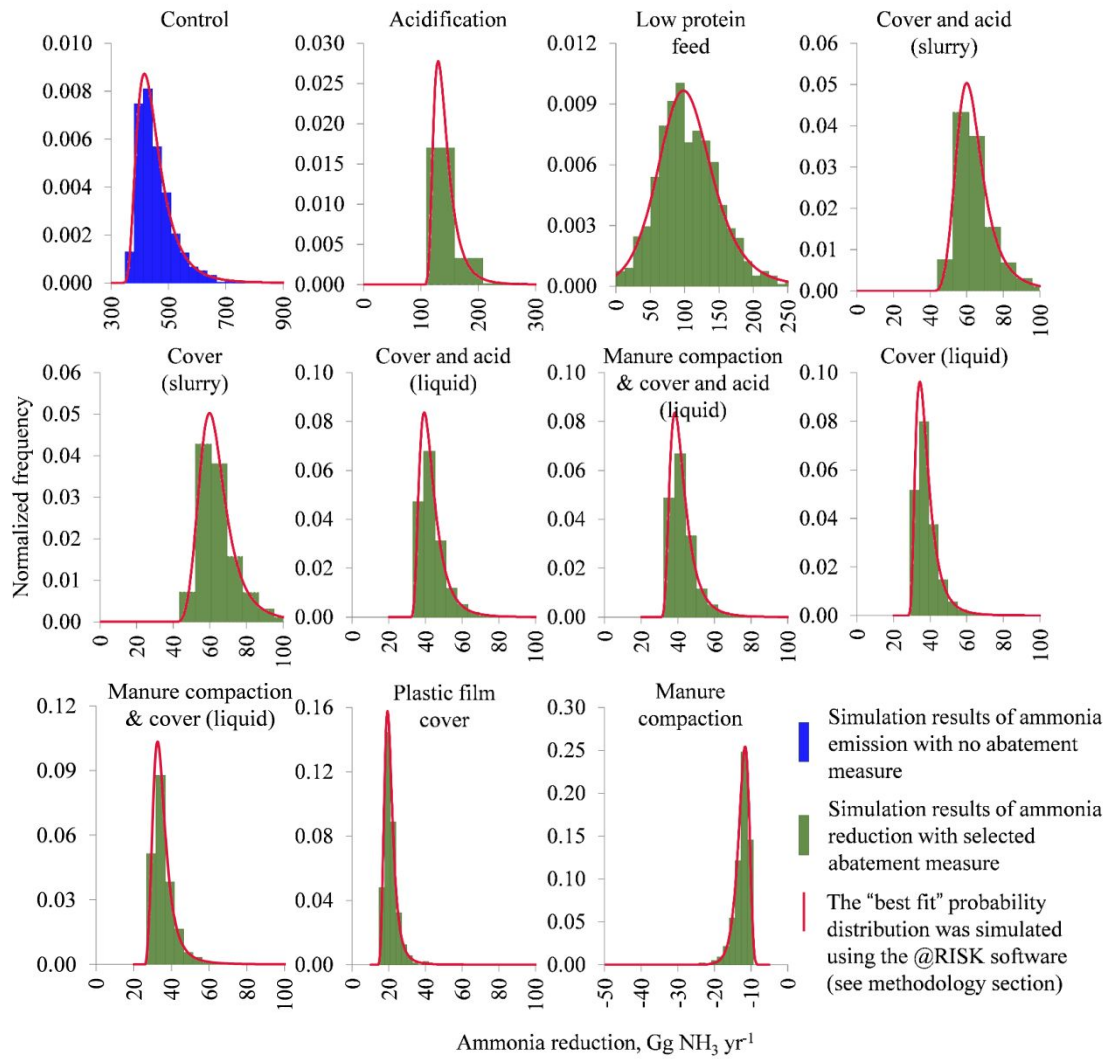

231

232

233

234

Figure S2. Uncertainty analysis of baseline ammonia emission for dairy production in China in 2015 and ammonia reduction under selected abatement options. The respective scenarios are described in Section 2.2 in the main text.

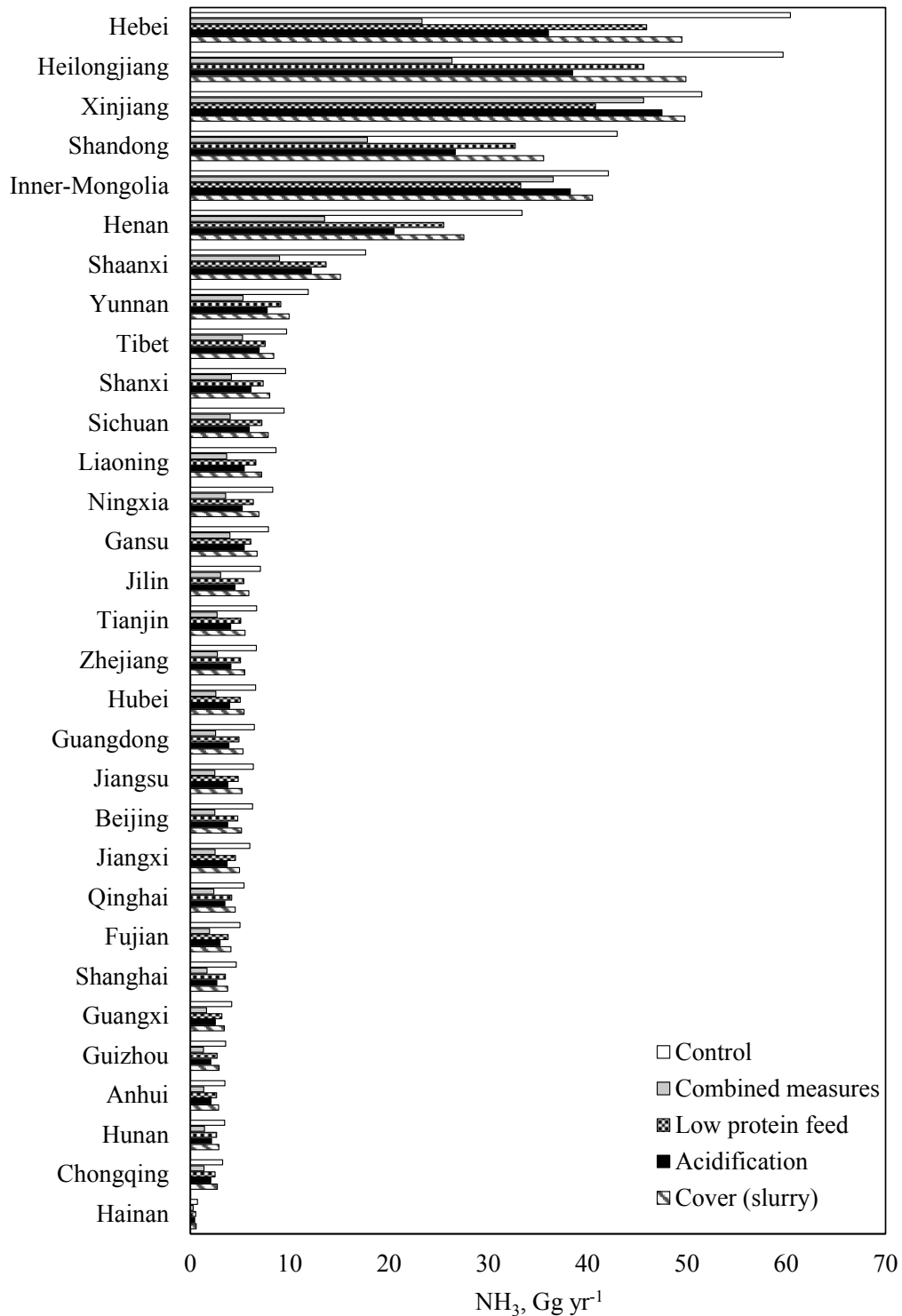

236

237

238

239

Figure S3. Ammonia emission without and with four selected abatement scenarios from dairy production system in different regions of China in 2015. The respective scenarios are described in Section 2.2 in the main text.

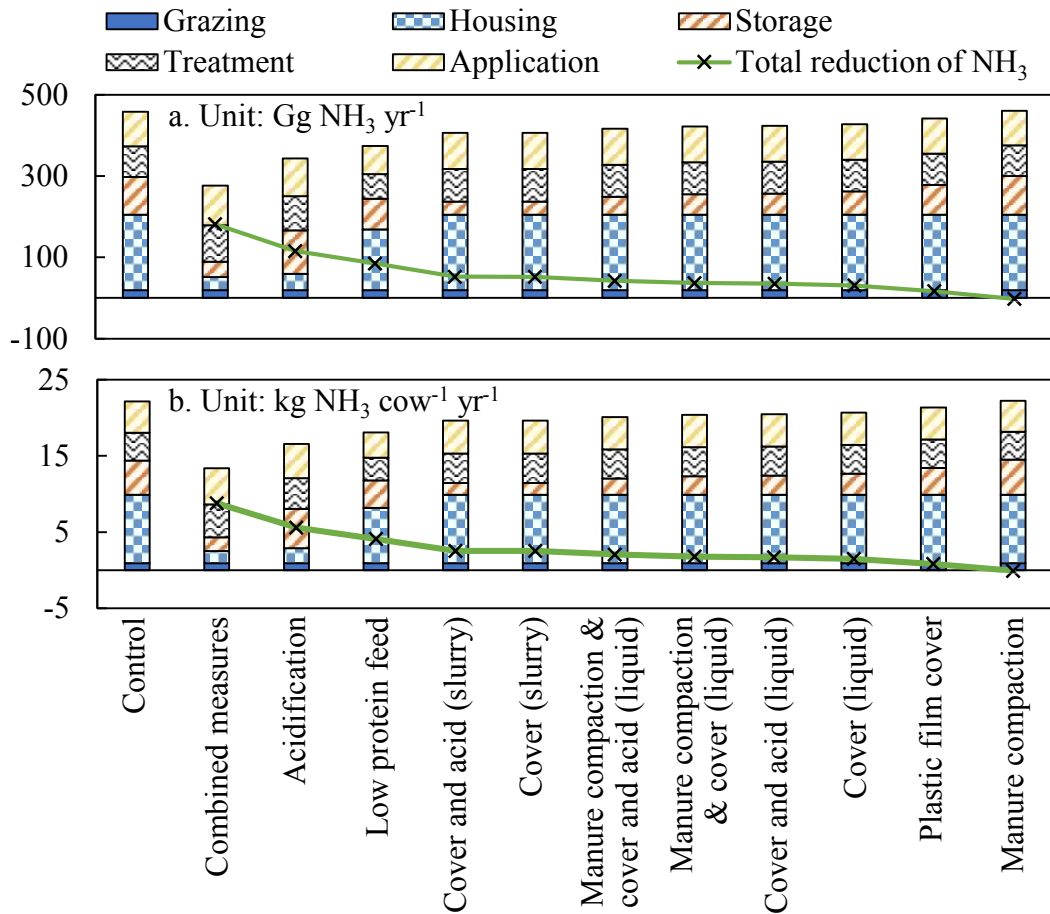

240

241

242

243

244

245

Figure S4. Total annual ammonia emission and reduction (a) and ammonia emission and reduction on an animal basis (b) from abatement options for dairy production in China in 2015, based on 80% of reduction efficiency achieved. Bars are ammonia emissions from different manure management stages, and green lines are total reduction of ammonia. The respective scenarios are described in Section 2.2 in the main text.

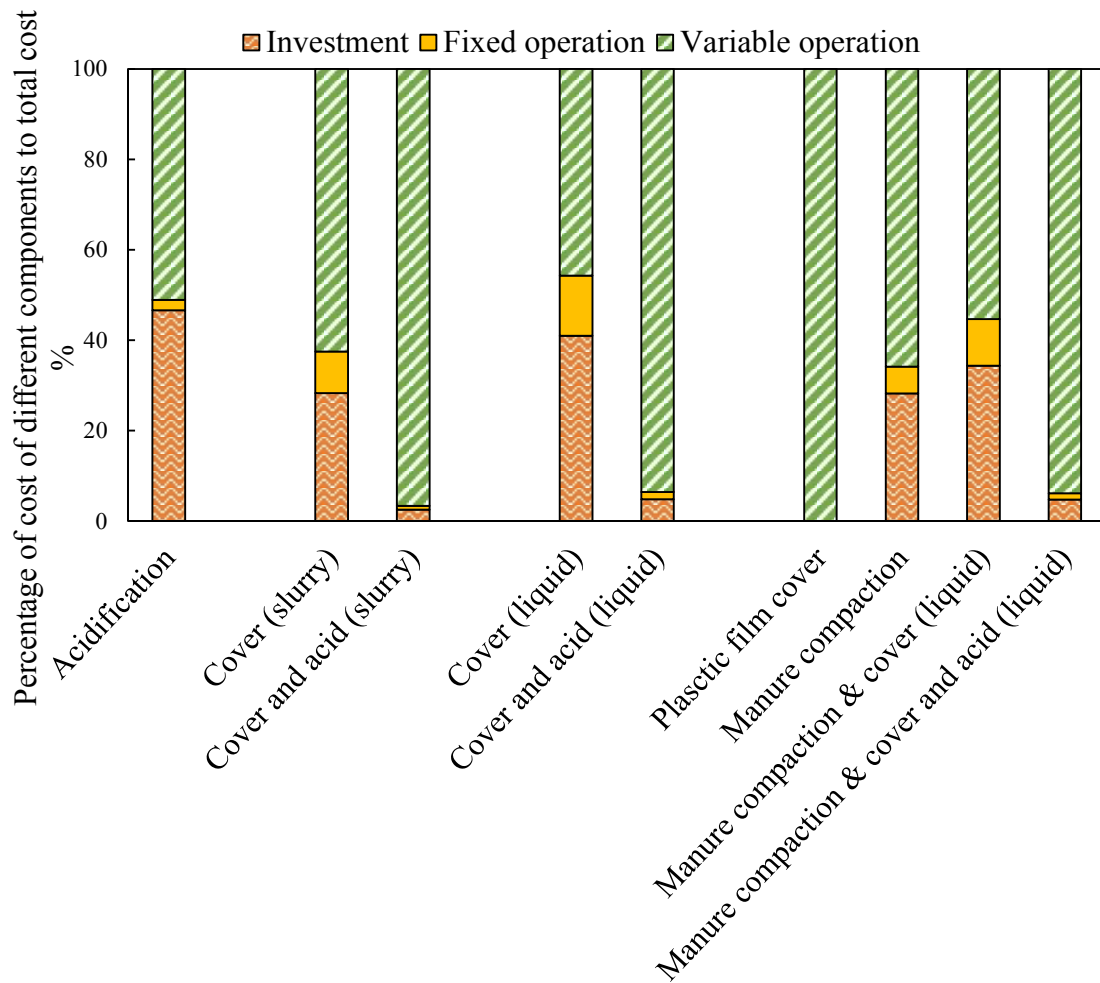

246
 247
 248
 249

Figure S5. Cost structure for technical implementation of NH₃ emission abatement options. The respective scenarios are described in Section 2.2 in the main text.

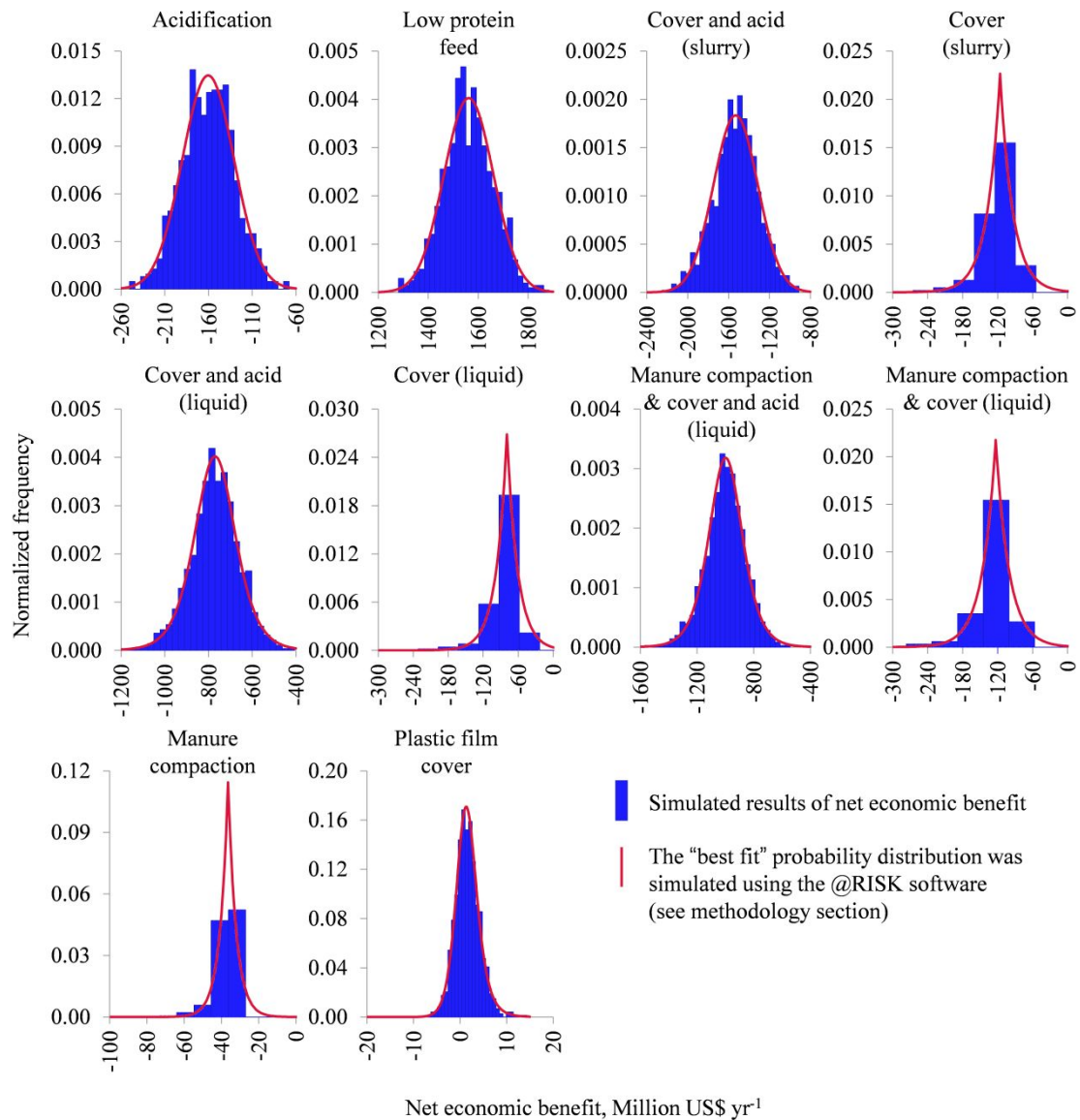

251

252 **Figure S6.** Uncertainty analysis of net economic benefit (without health damage cost
 253 saving) for selected abatement options. The respective scenarios are described in
 254 Section 2.2 in the main text.

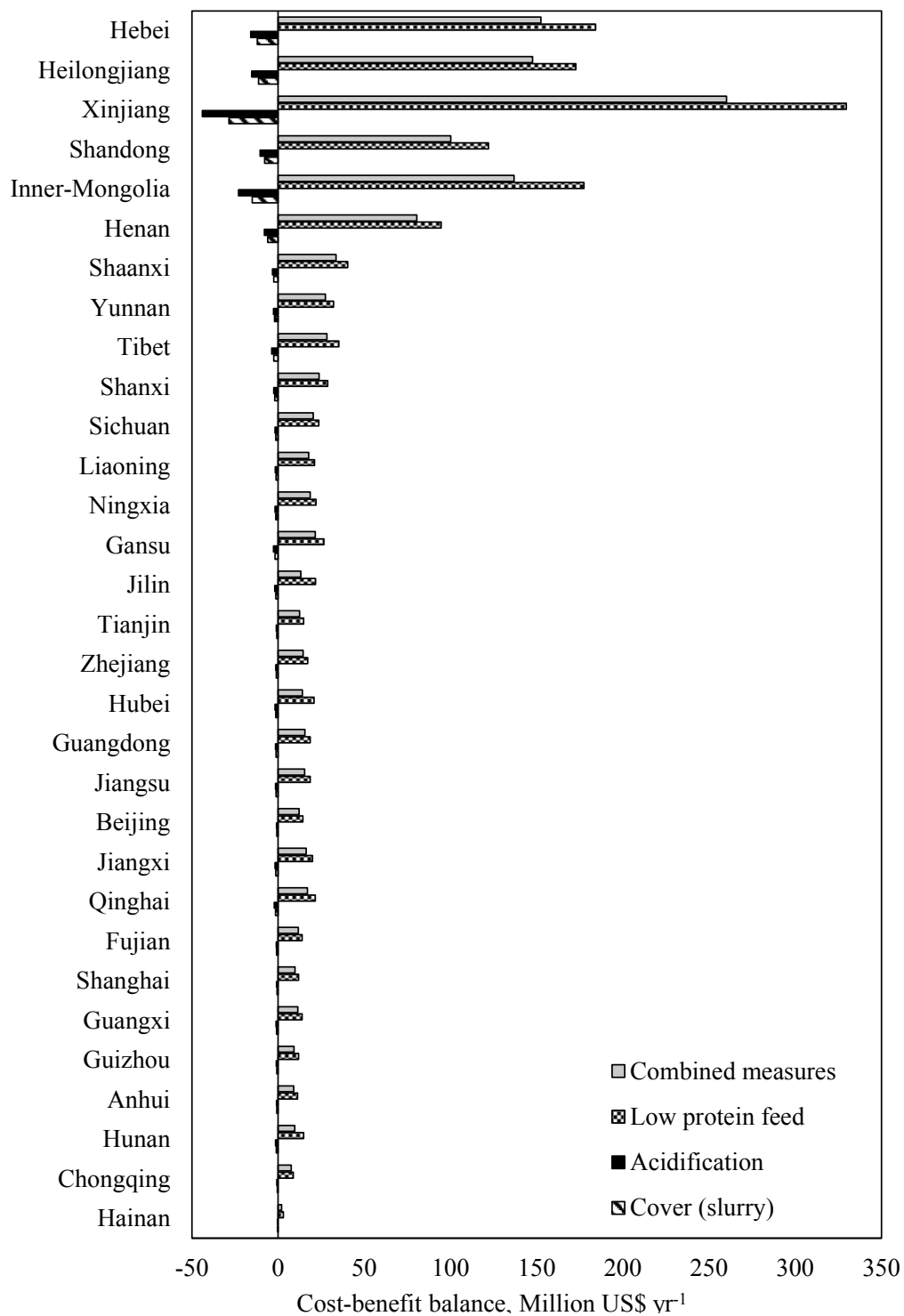

255
 256 **Figure S7.** Cost-benefit balance (fertilizer saving minus technical implementation cost)
 257 in different region for mitigation options applied to dairy production in 2015. A positive
 258 value refers to net benefit from the balance, and a negative value refers to net cost. The
 259 respective scenarios are described in Section 2.2 in the main text.

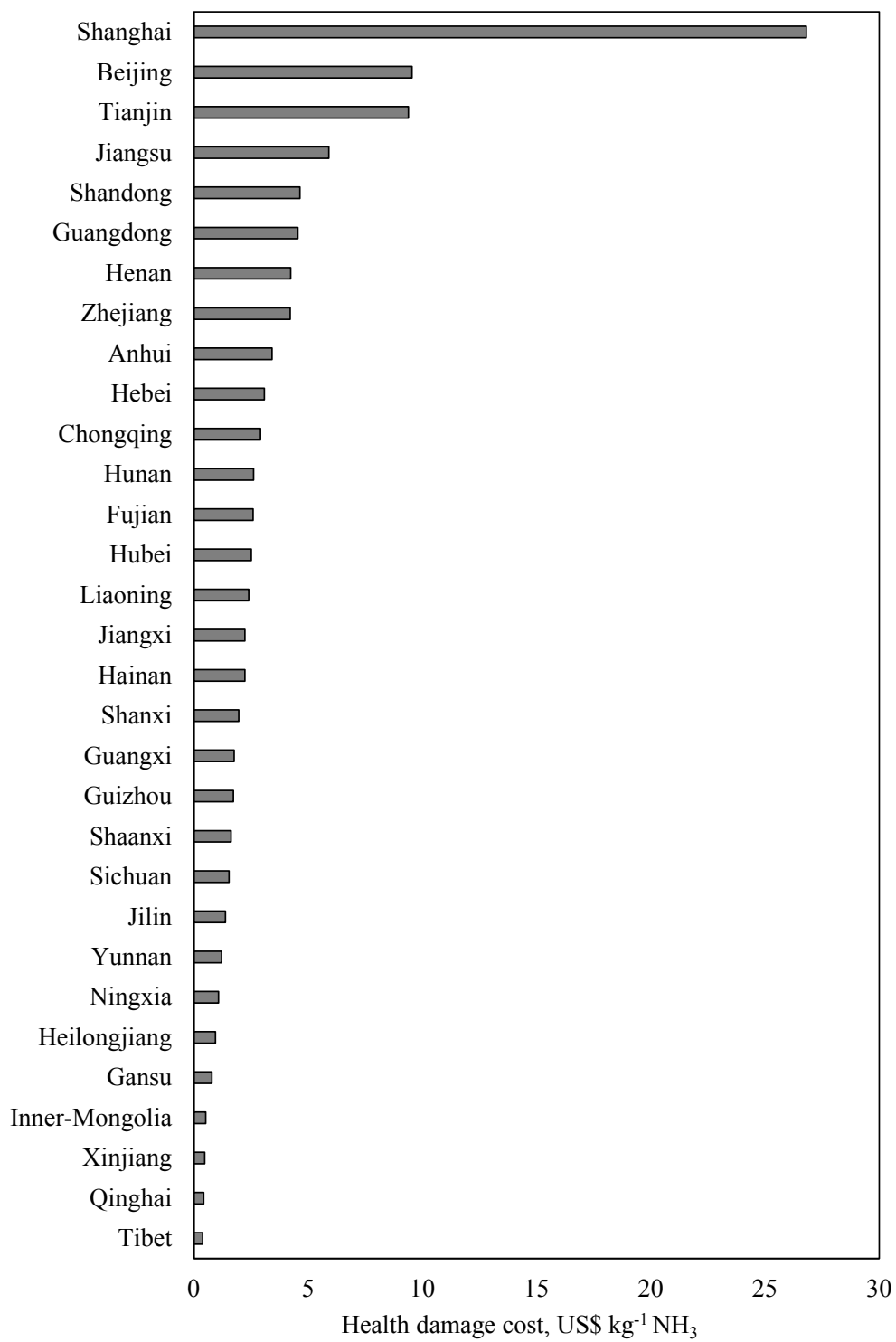

260

261

Figure S8. Regional variation of health damage cost based on 10% adjustment factor.

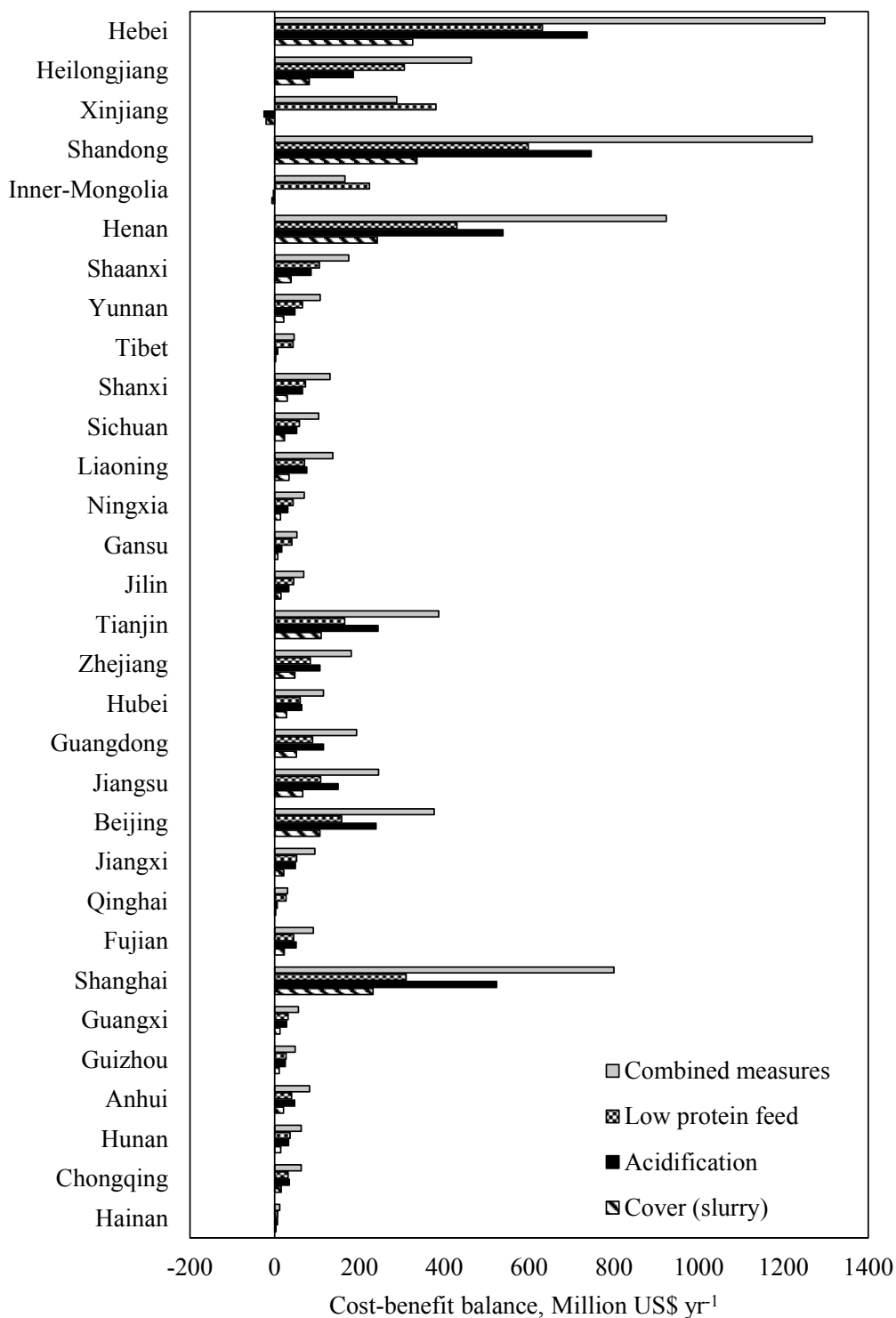

262
263
264
265
266
267

Figure S9. Cost-benefit balance (sum of fertilizer saving and health damage cost saving with European dataset minus technical implementation cost) in different region for mitigation options applied to dairy production in 2015. A positive value refers to net benefit from the balance, and a negative value refers to net cost. The respective scenarios are described in Section 2.2 in the main text.

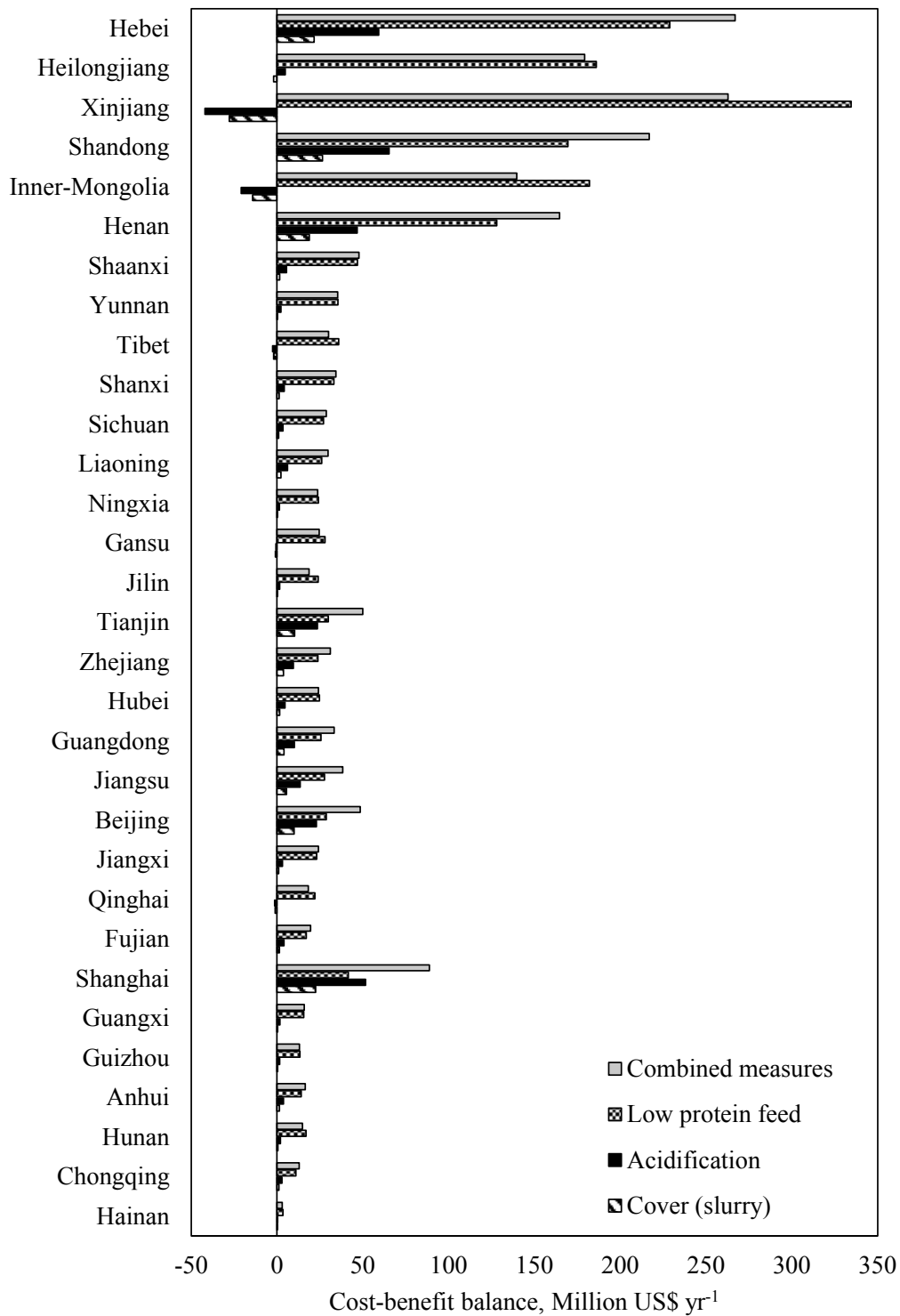

268
 269 **Figure S10.** Cost-benefit balance (sum of fertilizer saving and health damage cost saving
 270 with adjustment factor at 10% minus technical implementation cost) in million US\$ in
 271 different region for mitigation options applied to dairy production in 2015. A positive
 272 value refers to net benefit from the balance, and a negative value refers to net cost. The
 273 respective scenarios are described in Section 2.2 in the main text.

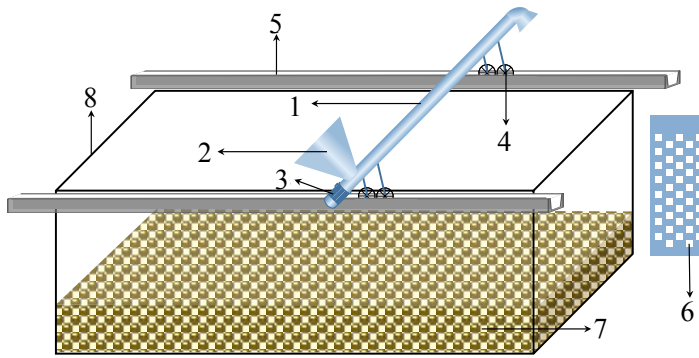

1.U-spiral conveyor; 2. hopper; 3. electric motor; 4. caster; 5. track; 6. mesh on the bottom of conveyor; 7. slurry or liquid manure; 8. storage facility.

274
275

Figure S11. Diagram of coverage system during housing.

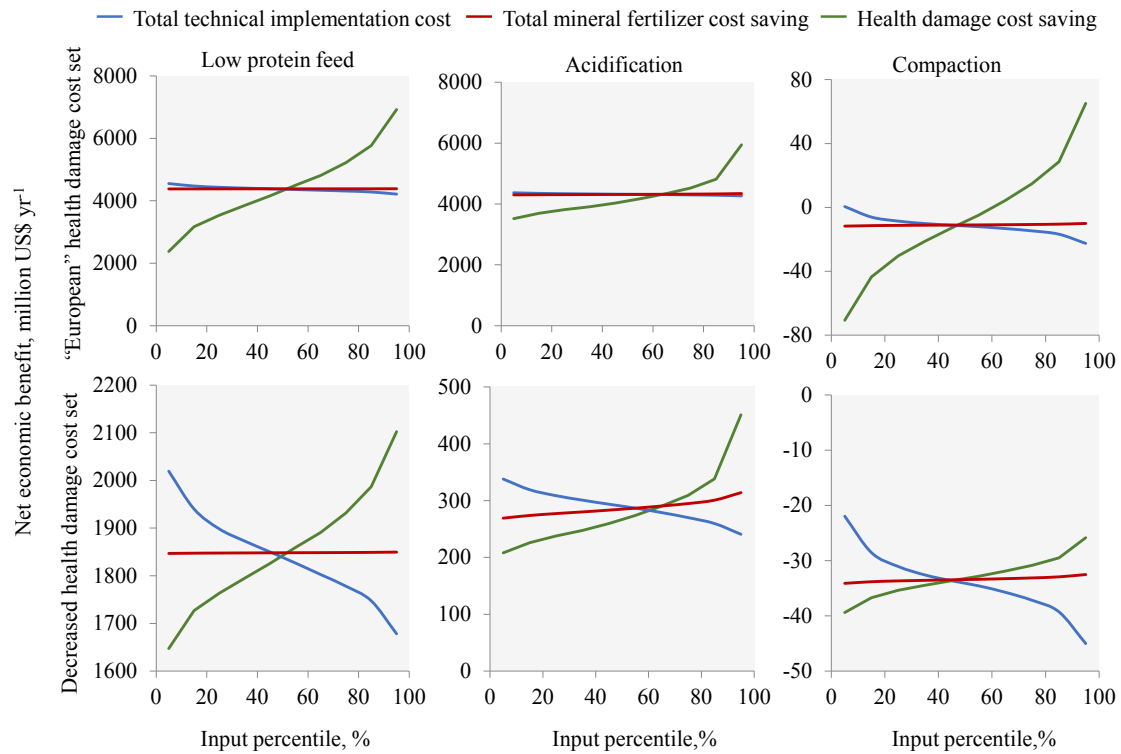

276

277

278

279

280

281

282

283

284

Figure S12. Sensitivity analysis of net economic benefit with health damage cost saving under selected abatement options. The respective scenarios are described in Section 2.2 in the main text. Costs for each respective abatement measure vary on X-axis. Y-axis shows how the value of net economic benefit changes as the sampled input value changes. The “European” health damage cost set applies the value of a life year derived by Brink et al.¹¹ Only 10% of this value is used in the decreased health damage cost set, as used by Gu et al.^{5, 12}

285 **References**

- 286 1. Pereira, J.; Fangueiro, D.; Misselbrook, T. H.; Chadwick, D. R.; Coutinho, J.;
287 Trindade, H. Ammonia and greenhouse gas emissions from slatted and solid floors
288 in dairy cattle houses: A scale model study. *Biosyst Eng.* **2011**, 109, 148-157.
- 289 2. Wheeler, E. F.; Adviento-Borbe, M. A. A.; Topper, P. A.; Brown, N. E.; Varga, G.
290 Ammonia and greenhouse gas emissions from dairy freestall barn manure. *American*
291 *Society of Agricultural and Biological Engineers*. Rhode Island, June 29-July 2,
292 **2008**, 1.
- 293 3. Lee, C.; Hristov, A.; Dell, C.; Feyereisen, G.; Kaye, J.; Beegle, D. Effect of dietary
294 protein concentration on ammonia and greenhouse gas emitting potential of dairy
295 manure. *J. Dairy Sci.* **2012**, 95, 1930–1941.
- 296 4. Chadwick, D. Emissions of ammonia, nitrous oxide and methane from cattle manure
297 heaps: effect of compaction and covering. *Atmos Environ.* **2005**, 39(4), 787-799.
- 298 5. Gu, B., Ju, X., Chang, J., Ge, Y., Vitousek, P. M. Integrated reactive nitrogen
299 budgets and future trends in China. *P. Natl. Acad. Sci. USA* **2015**, 112, 8792-8797.
- 300 6. Gu, B.; Ge, Y.; Chang, S. X.; Luo, W.; Chang, J. Nitrate in groundwater of China:
301 Sources and driving forces. *Global Environ. Change* **2013**, 23, 1112-1121.
- 302 7. Oenema, J., Burgers, S., van Keulen, H., van Ittersum, M. Stochastic uncertainty
303 and sensitivities of nitrogen flows on dairy farms in The Netherlands. *Agr. Syst.*
304 **2015**, 137, 126-138.
- 305 8. Oenema, O., Kros, H., de Vries, W. Approaches and uncertainties in nutrient

- 306 budgets: implications for nutrient management and environmental policies. *Eur. J.*
307 *Agron.* **2003**, 20, 3-16.
- 308 9. Flysjö, A., Henriksson, M., Cederberg, C., Ledgard, S., Englund, J. E. The impact of
309 various parameters on the carbon footprint of milk production in New Zealand and
310 Sweden. *Agr. Syst.* **2011**, 104, 459-469.
- 311 10. Basset-Mens, C., Kelliher, F. M., Stewart, L., Cox, N. Uncertainty of global
312 warming potential for milk production on a New Zealand farm and implications for
313 decision making. *Int. J. Life Cycle Ass.* **2009**, 14, 630-638.
- 314 11. Brink, C.; van Grinsven, H.; Jacobsen, B. H.; Klimont, Z. Costs and benefits of
315 nitrogen in the environment. *In* The European Nitrogen Assessment ; Sutton, M. A.;
316 Howard, C. M.; Erisman, J. W.; Billen, G.; Bleeker, A.; Grennfelt, P.; van Grinsven,
317 H.; Grizzetti, B. Cambridge University Press: New York. **2011**.
- 318 12. Gu, B.; Ge, Y.; Ren, Y.; Xu, B.; Luo, W.; Jiang, H.; Gu, B.; Chang, J. Atmospheric
319 Reactive Nitrogen in China: Sources, Recent Trends, and Damage Costs. *Environ.*
320 *Sci. Technol.* **2012**, 46, 9420-9427.
321