

Supporting Information

Toward the recycling of low-GWP hydrofluorocarbon/hydrofluoroolefin refrigerant mixtures using composite ionic liquid-polymer membranes

Authors:

*Fernando Pardo, Sergio V. Gutiérrez-Hernández, Gabriel Zarca, Ane Urtiaga**

Department of Chemical and Biomolecular Engineering, Universidad de Cantabria,
Av. Los Castros 46, Santander 39005, Spain.

*Corresponding author e-mail address: urtiaga@unican.es

Supporting information consists of:

- Number of pages: 4
- Number of tables: 3
- Number of figures: 1

Table S1. Physical properties of refrigerants R32, R134a and R1234yf used in this work and their mixtures.

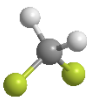
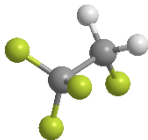
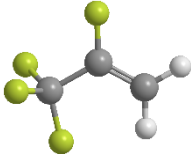
| | R32 | R134a | R1234yf | R513A | R454B |
|--|---|---|---|----------------------------------|------------------------------------|
| |  |  |  | 44 wt % R134a 56 wt % R1234yf | 68.9 wt % R32 31.1 wt % R1234yf |
| Molecular formula | CH ₂ F ₂ | C ₂ H ₂ F ₄ | C ₃ H ₂ F ₄ | - | - |
| MW (g mol ⁻¹) | 52.02 | 102.03 | 114.04 | 108.4 | 62.6 |
| <i>V</i> _c (cm ³ mol ⁻¹) | 122.4 | 200.2 | 238.6 | 209.8 | 142.7 |
| Normal boiling point (K) | 221.5 | 247.1 | 243.6 | 244.0 | 222.3 |
| <i>T</i> _c (K) | 351.3 | 374.2 | 367.9 | 369.7 | 354.1 |
| <i>P</i> _c (bar) | 57.8 | 40.6 | 33.8 | 37.7 | 50.4 |
| Acentric factor | 0.277 | 0.327 | 0.275 | - | - |
| Dipole moment (D) ^{1, 2} | 1.978 | 2.058 | 2.240 | - | - |
| Chung diameter (Å) ³ | 4.02 | 4.73 | 5.02 | - | - |
| GWP 100 years ⁴ | 677 | 1300 | 1 | 573 | 467 |

Table S2. Properties of the ILs used in this work at 30 °C and 1 bar.

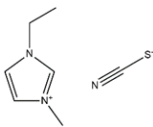
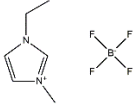
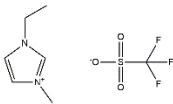
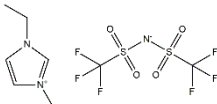
| IL | Chemical structure | CAS No. | η (mPa·s) | ρ (g·cm ⁻³) | <i>M</i> (g·mol ⁻¹) | <i>V</i> _m (cm ³ ·mol ⁻¹) |
|---|---|-------------|-------------------|---------------------------------|------------------------------------|--|
| [C ₂ mim][SCN] |  | 331717-63-6 | 20.8 ⁵ | 1.114 ⁵ | 169.3 | 151.9 ⁵ |
| [C ₂ mim][BF ₄] |  | 143314-16-3 | 32.3 ⁶ | 1.279 ⁶ | 198.0 | 154.8 ⁶ |
| [C ₂ mim][OTf] |  | 145022-44-2 | 36.3 ⁵ | 1.382 ⁵ | 260.2 | 188.3 ⁵ |
| [C ₂ mim][Tf ₂ N] |  | 174899-82-2 | 27.2 ⁷ | 1.514 ⁷ | 391.3 | 258.5 ⁷ |

Table S3. Parameters of the exponential fitting to Eq. (10).

| Penetrant gas | Parameter | Neat Pebax®1657 | Pebax®1657 – 40 wt % [C ₂ mim][SCN] | Pebax®1657 – 40 wt % [C ₂ mim][BF ₄] |
|---------------|--------------------------|-----------------|--|---|
| R32 | P_0 (barrer) | 135.5 | 201.5 | 199.9 |
| | m (bar ⁻¹) | 0.163 | 0.130 | 0.183 |
| | r^2 | 0.9996 | 0.9947 | 0.9934 |
| R134a | P_0 (barrer) | 51.58 | 52.87 | 60.58 |
| | m (bar ⁻¹) | 0.389 | 0.205 | 0.347 |
| | r^2 | 0.9857 | 0.9969 | 0.9960 |
| R1234yf | P_0 (barrer) | 13.69 | 10.58 | 11.54 |
| | m (bar ⁻¹) | 0.155 | 0.032 | 0.067 |
| | r^2 | 0.9907 | 0.9937 | 0.9702 |

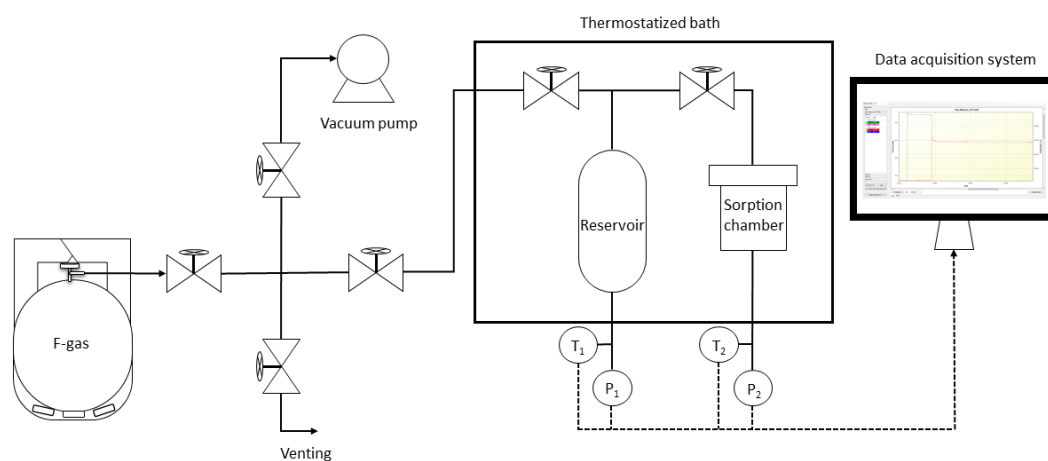


Figure S1. Schematic diagram of the dual volume pressure decay sorption system.

References

- (1) Meyer, C. W.; Morrison, G., Dipole moments of seven refrigerants. *J. Chem. Eng. Data* **1991**, 36, (4), 409-413. DOI: 10.1021/je00004a019
- (2) Sampson, C. C.; Kamson, M.; Hopkins, M. G.; Stanwix, P. L.; May, E. F., Dielectric permittivity, polarizability and dipole moment of refrigerants R1234ze(E) and R1234yf determined using a microwave re-entrant cavity resonator. *J. Chem. Thermodyn.* **2019**, 128, 148-158. DOI: 10.1016/j.jct.2018.07.011
- (3) Chung, T. H.; Ajlan, M.; Lee, L. L.; Starling, K. E., Generalized multiparameter correlation for nonpolar and polar fluid transport properties. *Ind. Eng. Chem. Res.* **1988**, 27, (4), 671-679. DOI: 10.1021/ie00076a024
- (4) IPCC, 2013: Summary for Policymakers. In: Climate Change 2013: The Physical Science Basis. Contribution of Working Group I to the Fifth Assessment Report of the Intergovernmental Panel on Climate Change [Stocker, T.F., D. Qin, G.-K. Plattner, M. Tignor, S.K. Allen, J. Boschung, A. Nauels, Y. Xia, V. Bex and P.M. Midgley (eds.)]. Cambridge University Press, Cambridge, United Kingdom and New York, NY, USA.
- (5) Freire, M. G.; Teles, A. R. R.; Rocha, M. A. A.; Schröder, B.; Neves, C. M. S. S.; Carvalho, P. J.; Evtuguin, D. V.; Santos, L. M. N. B. F.; Coutinho, J. A. P., Thermophysical Characterization of Ionic Liquids Able To Dissolve Biomass. *J. Chem. Eng. Data* **2011**, 56, (12), 4813-4822. DOI: 10.1021/je200790q
- (6) Neves, C. M. S. S.; Kurnia, K. A.; Coutinho, J. A. P.; Marrucho, I. M.; Lopes, J. N. C.; Freire, M. G.; Rebelo, L. P. N., Systematic Study of the Thermophysical Properties of Imidazolium-Based Ionic Liquids with Cyano-Functionalized Anions. *J. Phys. Chem. B* **2013**, 117, (35), 10271-10283. DOI: 10.1021/jp405913b
- (7) Gouveia, A. S. L.; Bernardes, C. E. S.; Tomé, L. C.; Lozinskaya, E. I.; Vygodskii, Y. S.; Shaplov, A. S.; Lopes, J. N. C.; Marrucho, I. M., Ionic liquids with anions based on fluorosulfonyl derivatives: From asymmetrical substitutions to a consistent force field model. *Phys. Chem. Chem. Phys.* **2017**, 19, (43), 29617-29624. DOI: 10.1039/C7CP06081E