

THE PHOTO-INHIBITION OF SEED GERMINATION  
AND THE INDUCTION OF SECONDARY DORMANCY

by P.A. LAMBTON

Submitted to the University of Leicester in  
fulfilment of the requirement for the Degree  
of Doctor of Philosophy.

September, 1985.

Dept. of Botany,  
University of Leicester,  
University Road,  
Leicester.

ProQuest Number: U360627

All rights reserved

INFORMATION TO ALL USERS

The quality of this reproduction is dependent upon the quality of the copy submitted.

In the unlikely event that the author did not send a complete manuscript and there are missing pages, these will be noted. Also, if material had to be removed, a note will indicate the deletion.

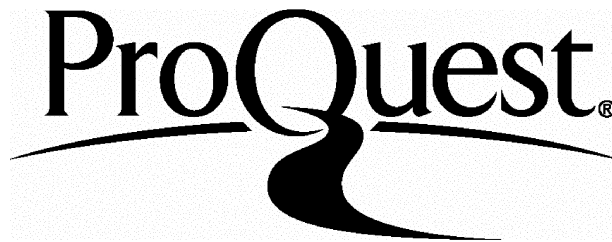

ProQuest U360627

Published by ProQuest LLC(2015). Copyright of the Dissertation is held by the Author.

All rights reserved.

This work is protected against unauthorized copying under Title 17, United States Code.  
Microform Edition © ProQuest LLC.

ProQuest LLC  
789 East Eisenhower Parkway  
P.O. Box 1346  
Ann Arbor, MI 48106-1346



X750167350

## ACKNOWLEDGEMENTS

I would like to thank Professor H. Smith for providing me with the opportunity to study in the Botany Department at Leicester for three years, and for his support during that period. Thanks to all those in the Botany Department who made it a happy time.

Thanks to my mother for her great tolerance in typing out this thesis.

And thank you, Maxine, for being patient.

## CONTENTS

	<u>Page</u>
ABSTRACT	1
INTRODUCTION	3
1. Brief introduction to the phytochrome system	3
2. Light conditions in the natural environment	7
REVIEW OF BACKGROUND LITERATURE	10
1. Seed maturation and primary dormancy	11
1a) Light quality	11
1b) Photoperiod and light quantity	13
2. Breaking of dormancy and promotion/inhibition of seed germination	16
2a) White light	16
2b) Vegetative canopy light	24
2c) Soil light	26
3. Induction and control of secondary dormancy	31
3a) Dormancy and membranes	39
3b) Water stress and dormancy	50
AIMS OF THE PROJECT	56
MATERIALS AND METHODS	58
1. Light sources and their measurement	58
a) Light sources for controlling light quality	58
i Zeta cabinet	58
ii Modified fluorescent tube lighting bank	58
iii Zeta gradient	62
iv Fisons growth cabinet 3 gradient	64
b) Light sources for controlling light quantity	64
i Fluorescent white light	64
ii Fluorescent white light with supplementary far-red	64
iii Mixes of broad waveband light	66

MATERIALS AND METHODS	<u>Page</u>
1. Light sources and their measurement	
c) Light sources for construction of action spectrum	66
d) Measurement of light sources	69
e) Measurement of light transmission through seed testas	70
2. Experimental Procedures	
a) Effects of light quality and quantity on seed germination	71
i Light quality and quantity - general	71
ii Light quality - specific	72
iii Light quantity - specific	72
b) Effects of light on secondary dormancy induction	73
c) Imbibition experiments	73
d) Respiration measurements	73
3. Seed sources	75
RESULTS & DISCUSSION	76
Germination responses to various light regimes	76
1. Light quality	76
2. Light quantity	87
a) <u>Urtica urens</u>	87
b) <u>Chenopodium album</u>	94
c) <u>Amaranthus caudatus</u>	95
Dormancy induction under various light regimes	104
3. Light quality and primary dormancy	104
4. Light quality and secondary dormancy	104
Imbibition and respiration under various light regimes	114
5. Imbibition	114
6. Respiration	114
GENERAL DISCUSSION	120
SUMMARY	132

LIST OF FIGURES

	<u>Page</u>
Figure a : 1 Spectral photon distributions for the four compartments of the "zeta cabinet" when the far-red light filter comprised of a red and a green sheet of perspex	59
Figure a : 2 Spectral photon distributions for the four compartments of the "zeta cabinet" when the far-red light filter comprised of a sheet of far-red perspex	60
Figure a : 3 Arrangement of modified fluorescent tube lighting rack	61
Figure a : 4a/4b Typical spectral photon distribution from modified fluorescent tube lighting rack	63
Figure a : 5 Arrangement of zeta-gradient	61
Figure a : 6 Spectral photon distributions for the 13 sections of the "zeta gradient". Photoequilibrium ranges from 0.372 to 0.594	65
Figure a : 7 Spectral photon distributions for 7 points along the gradient of $\zeta$ in the Fisons growth cabinet. Photoequilibrium ranges from 0.237 to 0.485	
Figure a : 8a/8b Light sources used for distinguishing between phytochrome mediated photoinhibition and blue light receptor mediated photoinhibition of germination	67
Figure a : 8c Apparatus used for action spectrum experiments	68
Figure a : 8e Apparatus for measuring seed testa light transmission	68
Figure 1 : 1a/1b Germination of <u>Chenopodium album</u> seeds shown in a stand of Sugar Beet	78
Figure 1 : 2 Germination of five species in response to photoequilibrium Established by the "zeta gradient"	81
Figure 1 : 3a-d/e-h Percentage light transmission of the seed testas of eight species over the range 400 to 800 nm	84 & 85
Figure 1 : 4 Germination response of <u>C. album</u> in the "zeta cabinet" fitted with two different types of far-red filter Red and green perspex Far-red perspex	86

	<u>Page</u>
Figure 2 : 1 Germination response of four species to different photoperiods and photon fluence rates of fluorescent white light	88
Figure 2 : 2 Germination response of <u>Urtica urens</u> to different photoperiods and photonfluence rates of fluorescent white light	88
Figure 2 : 3 Germination response of <u>U. urens</u> to a wide range of photoperiods at a high and a low photon fluence rate of fluorescent white light	89
Figure 2 : 4a Germination response of <u>U. urens</u> to low daily photon fluence (18 mmols m <sup>-2</sup> ) given over different daily photoperiods of relatively short duration	91
Figure 2 : 4b Germination response of <u>U. urens</u> to high daily photon fluence (720 mmols m <sup>-2</sup> ) given over different daily photoperiods of relatively long duration	91
Figure 2 : 5 Germination response of <u>U. urens</u> to different light regimes set within an 8h photoperiod.	93
Figure 2 : 6 Germination response of <u>C. album</u> to photoequilibrium under different photoperiods	93
Figure 2 : 7 Dose-response plot linear regressions for germination of <u>A. caudatus</u> under monochromatic light sources	97 & 98
Figure 2 : 8 Action spectrum of photoinhibition of <u>A. caudatus</u> seed germination	99
Figure 2 : 9 ln. H. versus germination response relationships for <u>A. caudatus</u> under various light sources	101
Figure 2 : 10 Germination response of <u>A. caudatus</u> to red plus far-red and blue light sources establishing similar photoequilibria.	103
Figure 3 : 1 Germination response to photoequilibrium and darkness of <u>C. album</u> seeds matured under different light qualities	105
Figure 3 : 2 Germination response to photoequilibrium of <u>Taraxacum officianale</u> seeds matured under different light qualities	105

	<u>Page</u>
Figure 4 : 1a/lb Induction of secondary dormancy (measured as the response to fluorescent white light) in seeds incubated under different light regimes	107
Figure 4 : 2 Effect of photon fluence rate on induction of secondary dormancy (as measured by response to fluorescent white light) in <u>C. album</u> seeds	108
Figure 4 : 3 Effect of light ( $\phi_c = 0.346$ , PAR = $\mu\text{mols m}^{-2} \text{s}^{-1}$ ) on induction of secondary dormancy (as measured by response to darkness) in <u>A. caudatus</u> seeds	108
Figure 4 : 4 Effects of 2 days' incubation in light establishing different photoequilibria (constant PAR of $45 \mu\text{mols m}^{-2} \text{s}^{-1}$ ) on induction of secondary dormancy (as measured by response to darkness) of <u>A. caudatus</u> seeds	110
Figure 4 : 5 Effects of 2 days' incubation in light of different photon fluence rates (constant $\phi_c$ of 0.346) on the induction of secondary dormancy (as measured by response to darkness) of <u>A. caudatus</u> seeds	110
Figure 4 : 6 Effects of 2 days' incubation in light establishing different photoequilibria (constant H of $0.01 \text{s}^{-1}$ ) on the induction of secondary dormancy (as measured by response to darkness) of <u>A. caudatus</u> seeds	112
Figure 4 : 7 Regression lines from figs. 4 : 4 and 4 : 6 (constant PAR and constant H respectively) showing H values for different treatments	112
Figure 5 : 1 Imbibition kinetics of <u>A. caudatus</u> seeds in distilled water at $20^\circ\text{C}$	115
Figure 6 : 1 Respiration rates (oxygen uptake) of <u>A. caudatus</u> seeds incubated under an inhibitory light source and in darkness	116
Figure 6 : 2 Respiration rates of <u>A. caudatus</u> seeds under prolonged exposure to an inhibitory light source and the recovery of the seeds when the light is switched off after 36 or 52 hours	118
Figure 6 : 3 Respiration rates of <u>A. caudatus</u> seeds incubated under 2 inhibitory light sources establishing different photoequilibria	119

LIST OF TABLES

	<u>Page</u>
Table 1 : 1 Characteristics of light conditions beneath Sugar Beet canopy during experiment of fig. 1 : 1	77
Table 1 : 2 Germination of a range of open and shade habit species under lights establishing different photoequilibria and in darkness	80

## ABSTRACT

A study of photoinhibition of seed germination and the induction of secondary dormancy has been made on weedy species that tend to produce large numbers of small, light-sensitive seeds.

Both light-requiring (e.g., Chenopodium album) and light-inhibited (e.g., Amaranthus caudatus) species were used but nevertheless were found to show similar responses to high fluence irradiation, differences being largely ones of varying sensitivity.

All species tested (except Digitalis purpurea) showed a marked inhibition of germination in continuous fluorescent white light supplemented with far-red compared to the response to fluorescent white light only.

Urtica urens and A. caudatus germination, however, could be inhibited by fluorescent white light only and this response was dependent on both time and fluence rate. Interestingly, A. caudatus is a dark germinator whereas U. urens is light requiring (i.e., a small amount of light promotes germination but a large amount is inhibitory). The inhibitory action of prolonged light is dependent on photon fluence rate. In photoinhibition mediated through phytochrome cycling rate of the pigment appears to be important. However, cycling rate per se cannot explain all the observed responses; and the interruption of dark processes is another important factor. Cycling rate effects are increased when photoequilibrium is low. There is also a blue light photoreceptor of unknown form which shows fluence dependent characteristics in its photoinhibitory activity.

Secondary dormancy is induced in seeds which have the ability to germinate but are prevented from doing so. In respect to the light environment, the same light conditions which inhibit germination also tend to induce secondary dormancy although there is no direct evidence on the action of blue light operating through the blue photoreceptor.

The depth of secondary dormancy increases with the time of incubation in the inhibitory conditions and also is deeper for low photoequilibrium and high photon fluence rate. High photon fluence rate fluorescent white light inhibits the germination of U. urens but the high photoequilibrium established allows the seed to germinate in subsequent darkness.

Photoinhibition of germination and induction of secondary dormancy have adaptive advantages for survival of the species since seedlings can avoid the competitive stresses of a stand of vegetation and the desiccating environment of the soil surface in full sunlight. Photoinhibition appears to act by preventing the active processes of germination from occurring, which thus enables the seeds to pass through cycles of hydration and dehydration without being damaged.

INTRODUCTION

1. Brief introduction to the phytochrome system

The germination of seeds in response to light was first found to be wavelength dependent in the 1930s (Flint and McAllister, 1935, 1937). The further investigations of these effects by Borthwick and Hendricks in the early 1950s led to the discovery that the promotion of germination by red light, and the inhibition of germination by far-red light, were photoreversible such that red-light-induced promotion of germination could be negated by a subsequent far-red irradiation.

This important discovery led to the conclusion that the pigments involved in these responses were, in fact, just one pigment which existed in two forms. The two forms could inter-convert under red and far-red light. The pigment was later termed phytochrome. A simple scheme was drawn up:

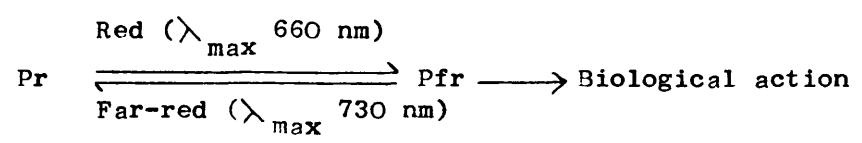

; where Pr is the red-light-absorbing form of phytochrome, and Pfr is the far-red-light-absorbing form of phytochrome which was also thought to be active.

Thus when Pr absorbs red light it is converted to Pfr and when Pfr absorbs far-red light it is converted to Pr. However, the two forms of phytochrome show considerable overlap of their absorption spectra (Butler et al, 1964). This fact has several important implications:

- 1), 100% Pfr can never be achieved, although 100% Pr is possible at wavelengths above 750 nm;
- 2), under most broad-band, or narrow-band sources at wavelengths less than 750 nm, light absorption by both Pr and Pfr determines that an equilibrium will be established between the two forms. This equilibrium is given as Pfr/P total and is symbolised as  $\theta$ . In continuous light and in the absence of competing dark reactions, the

equilibrium is termed photoequilibrium.  $\phi$  can be calculated from the known properties of phytochrome and the spectral photon distribution of the light source (see Materials and Methods, part d);

3), at equilibrium cycling will occur between Pr and Pfr;

4), the cycling rate between Pr and Pfr will depend on the photon fluence rate of the light and the wavelength. An arbitrary estimate of cycling rate (H) can be calculated (see Materials and Methods, part d).

Further complications arise from the molecular properties of phytochrome. Pfr is lost from the system in two ways:

1), destruction of Pfr shows first order kinetics; i.e., destruction is related to the concentration of Pfr. Generally Pfr appears to be less stable in vivo than Pr, although Pfr seems to be less unstable in seeds than in seedlings;

2), dark reversion of phytochrome occurs from Pfr to Pr since Pr has a lower thermodynamic energy level than Pfr. Dark reversion is a slow reaction in comparison to photoconversion but nevertheless can become theoretically important in reducing the proportion of Pfr present when photon fluence rate is sufficiently low;

3), Pr is produced at a steady rate; i.e., zero order kinetics.

Blue light is absorbed by phytochrome to a similar extent by both Pr and Pfr but absorption of the red and far-red wavelengths is greater than that of blue light. Blue light is also absorbed by another pigment called "cryptochrome". This can therefore cause confusion about which pigment is involved in blue-light-mediated responses.

Pr and Pfr do not interconvert directly. There are intermediates for conversions in both directions and the intermediates appear to be different for each pathway (for review, see Kendrick and Spruit, 1977). Accumulation of intermediates can occur, especially at high photon fluence rates. The last intermediate in the Pr to Pfr pathway, meta Rb, is the slowest to relax and therefore it is meta Rb which tends to

accumulate. There are no known physiological effects of intermediates (Kendrick and de Kok, 1983).

A slightly more detailed scheme for phytochrome conversions can now be presented:

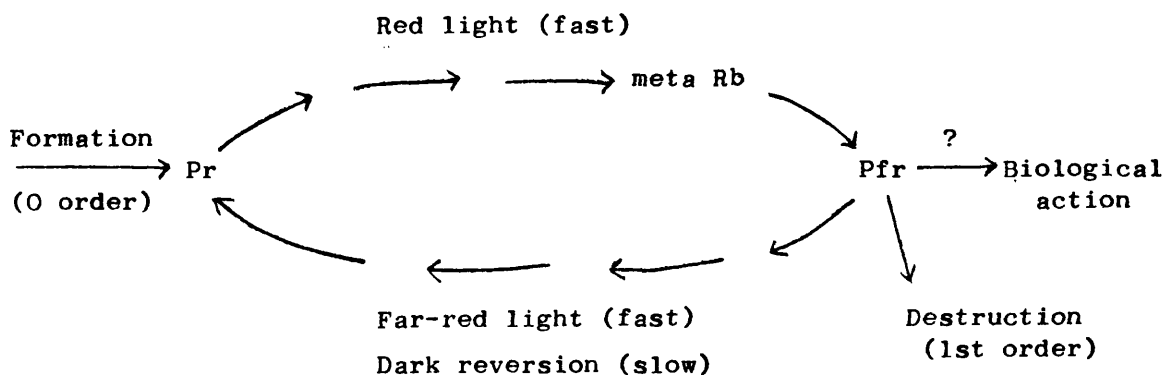

This scheme does not explain how phytochrome acts in the physiology of plants. Various models of phytochrome action have been presented but none proved. However, it is commonly speculated that Pfr interacts with another substance X which may be a membrane or a membrane-associated molecule.

There are some further characteristics of the phytochrome system in seeds which differ from the situation in seedlings. Firstly, Pfr appears to be relatively stable and is not degraded; and, secondly, a process, which appears to be an Inverse Dark Reversion, occurs where Pfr is formed in darkness (Boisard, 1968).

Both of these phenomena may be explained on the basis of the low hydration of phytochrome within seeds. In particular it was found that the completion of pathways of intermediates between Pr and Pfr, and vice versa, depended on conformational changes in the protein structure of the phytochrome molecule (see Kendrick and Spruit, 1977). Completion of the conversion pathways could not occur if hydration was too low and Inverse Dark Reversion was subsequently explained as the slow relaxation of blocked intermediates to the Pfr form. This may explain the continuous or intermittent far-red light treatments that are required to inhibit the germination of some species; although the explanation

calls for intermediates to be held in the hydrated form for prolonged periods.

The simple scheme of phytochrome conversion can be used to explain those reactions which are grouped under low energy responses (LER). Such responses are dependent on photon fluence rate and wavelength. For example, in seed germination, red light will promote germination and the number of seeds germinating is dependent on the photon fluence up to saturation of the response. Promotion of germination can be reversed by a subsequent pulse of far-red light which removes the Pfr. After a period of Pfr action following a red light pulse, the effectiveness of a far-red light pulse to reverse the promotion of germination declines until germination is unaffected. The seed is said to have "escaped from reversibility".

Photoinhibition of germination may still occur after seeds have escaped from reversibility. During the later stages of germination light can again inhibit germination, however, the characteristics for this photoinhibition are different from LER reactions. This later photoinhibition is classed under a group of response known as high irradiance reactions (HIR) since they occur mostly under conditions of prolonged high irradiance. Reciprocity fails in HIR responses and dependence on wavelength is not so important since even light sources establishing high photoequilibria can cause photoinhibition of the germination of some seeds.

High irradiance reactions generally act in the same direction as a red light pulse (except, apparently, in seed germination). Many attempts have been made to explain the HIR in terms of phytochrome and this will be considered more fully in relation to seed germination in the review of the background literature. For the moment it is sufficient to note that light acts at two distinct points in controlling seed germination. Both the LER and HIR responses have relevance to seed

germination in the natural environment.

## 2. Light conditions in the natural environment

On a bright mid-summer day in Britain, the photon fluence rate in the 400 - 700 nm range can exceed  $2,000 \mu\text{mols m}^{-2} \text{s}^{-1}$  at noon. Obviously this decreases towards the ends of the day. By contrast, light quality (i.e. spectral photon distribution) remains remarkably constant throughout the day until shortly before sunset (or shortly after sunrise). During the main part of the day the spectrum is fairly constant in the 400 - 800 nm wavelength range; and also is hardly affected by cloud cover. Under these conditions the ratio of photon fluence rate at 655 - 665 nm to that at 725 - 735 nm (known as the red/far-red ratio or  $\zeta$ ) is close to one (actually 1.15) and calculated phytochrome photoequilibria ( $\phi_c$ ) is about 0.54 (Holmes and Smith, 1977).

Photoequilibrium is closely related to the  $\zeta$  value of many broadband light sources, such that  $\phi$  decreases as  $\zeta$  decreases. A graph showing the relationship between  $\phi$  and  $\zeta$  shows that the range of red/far-red ratios commonly found in terrestrial environments coincides with the maximum sensitivity of phytochrome for precise changes in photoequilibrium (Smith and Holmes, 1977; Smith, 1982). This relationship has been used as evidence that the function of phytochrome in the natural environment is to measure the red/far-red ratio of the light, thus enabling the plant to detect vegetative shade conditions, where  $\zeta$  is reduced (see below). The plant can use the information to alter its development to adapt to changes in the light environment (see Smith, 1982 for review).

The light incident on the earth can be separated into two components; that from the solar disc (direct light), and that from the rest of the sky (scattered light). Direct light is richer in the longer wavelengths (red and far-red) whereas the scattered light is richer in the shorter (blue) wavelengths. During the main part of the day the

direct and scattered components of the light combine to give an even spectrum, but, during the twilight hours, when the sun is near the horizon (solar angle less than  $10^{\circ}$ ), there is a shift in the spectral composition of the light. This is caused by the increasing pathlength through the Earth's atmosphere that the light must pass. The effects of this are: 1), increased absorption and scattering of the light; and 2), greater refraction of the solar beam which leads to an enrichment of longer wavelengths. The combination of these factors results in an altered spectral photon distribution such that proportionately more blue and far-red light are present during twilight than during the rest of the day. The higher proportion of far-red in the light at twilight results in a drop in the  $\zeta$  value of the light and consequently a reduction in the photostationary state (photoequilibrium may not be achieved at the low photon fluence rates found at twilight) of phytochrome. It has been postulated that the drop in  $\zeta$  during twilight may act as a 'zeitgeber' for photoperiodic measurement; however it is unlikely that the changes in light quality are consistent enough from day to day (Hughes et al, 1984). Unlike the situation during the greater part of the day, cloud cover can markedly affect the changes in light quality at twilight.

The red/far-red ratio is also altered markedly when light passes through a vegetative canopy. Chlorophyll in the leaves absorbs much of the blue and red wavelengths and some green light. By contrast, far-red light is well transmitted by a vegetative canopy, and this can result in marked drops in  $\zeta$ . Under a dense stand of sugar-beet light establishing  $\phi_c$  as low as 0.03 has been recorded (Hughes et al, 1984).

In the depth of shade existing under a high leaf-area-index sugar-beet canopy it is unlikely that calculated photoequilibrium can give a realistic indication of the state of the phytochrome since dark reversion (assuming it exists in vivo) would become increasingly

important compared to photo conversion. Based on an estimate of five hours for the half life of dark reversion of Pfr to Pr at 25°C, Frankland (1981) calculated that within a few millimetres of the soil surface, the rate of non-photochemical conversion of Pfr to Pr (dark reversion) would exceed the photochemical conversion of Pr to Pfr. Despite this, sufficient light may penetrate through the soil to stimulate germination even to depths of several millimetres. Although only one per cent of incident light penetrates to a depth of 2.2mm of soil (Wooley and Stoller, 1978) this still represents about  $20 \mu\text{mols m}^{-2} \text{ s}^{-1}$  on a sunny day. This level of light is more than sufficient to stimulate the germination of many species. Indeed it is more than the photosynthetic compensation point of many species.

The range of light conditions to be found in the natural environment are therefore considerable. Seeds must be able to detect these conditions and use the information to maximise their chances of survival. The phytochrome system in seeds is adapted to this function and will be studied in more detail in the following section. The possibility of a separate blue light receptor will also be considered.

## REVIEW OF BACKGROUND LITERATURE

The continued survival of annual species from season to season must by definition depend on the success of the seed shed in previous seasons in germination under conditions which will result in seedling survival and development into mature reproductive plants. In order to increase the chances of this happening it is important that the innate dormancy of individual seeds must vary considerably, even in the population from a single parent plant, thus ensuring that not all the seeds will germinate at once, since a disaster such as a late frost could kill all the seedlings.

Most annual species produce large numbers of seeds of small size and consequently small food reserves. It is important for the seed to germinate in response to critical environmental parameters which signal a high chance of rapid establishment as an autotrophic seedling. Since such conditions may occur infrequently it is important that seeds should be able to remain dormant but viable in the soil for many years; indeed it has been shown that some seeds can remain viable in the buried state for several decades (Kivilaan & Bandurski, 1973).

The reproductive strategies of annual plants, while primarily under genetic control, can be seen to be markedly modified by environmental factors such as daylength, light quality, temperature, water and nutrient availability, and soil conditions. These factors are important throughout the life-span of the seed and can be considered under three main headings:

- 1, Seed maturation and primary dormancy;
- 2, Breaking of dormancy and promotion/inhibition of seed germination;
- 3, Induction of secondary dormancy.

Since the subject of this thesis is the photo-control of seed germination, light effects will be given precedence. However the various environmental factors all interact in a complex manner and it is impossible to understand what happens in the field unless they are

considered, so brief mentions of non-photo-mediated effects will be made where applicable.

1. Seed Maturation and Primary Dormancy

1a) Light quality

Plants of Arabidopsis thaliana have been grown under light sources of different quality; i.e., cool white fluorescent (CWF), incandescent (I) and a mixture of the two (McCullough & Shropshire, 1970; Shropshire, 1973; Hayes & Klein, 1974). These light sources gave red/far-red values of 7, 0.6 and 1 respectively. The results of McCullough & Shropshire (1970) using A. thaliana race Estland showed that the light quality the seeds matured under affected their dark germination as follows:

CWF	36%
CWF + I	12%
I	0%

Seeds matured under I showed a much greater sensitivity to a pulse of red light than did seeds matured under the other two treatments. These results are consistent with the theory that it is the state in which the phytochrome exists when the seed dehydrates that is important for determining subsequent germinability. Experiments where the maturing seeds were irradiated with different light sources to those applied to the rest of the plant tend to confirm this. In A. thaliana the germination behaviour of the seed in relation to light quality is not determined until the seed is nearly mature.

Storage of harvested fruit of Cucumis sativus and Cucumis prophetarum in continuous red or far-red light showed great differences in the amount of photoreversible phytochrome (about 3 times as much under far-red) and the percentage of Pfr in the seeds (Gutterman & Porath, 1975). A positive relationship was found between the percentage Pfr and the percentage germination in seeds that were removed from fruit stored under

red or far-red light and germinated immediately when the moisture content of the seeds was still 30-45%. However, in cases where the seeds were dried before the germination test there was no difference in germination. This suggests that in large seeds, such as cucumber, the length of the drying time may be sufficient to allow dark reversion of Pfr to Pr.

A comparative study of light- and dark-germinating species was made by Cresswell & Grime (1981). They found a very good correlation between the light requirements for germination and the amount of chlorophyll that remained in the tissues covering the seeds. This chlorophyll acts in the same way as a vegetative canopy; i.e., red and blue light is absorbed while far-red is readily transmitted. Thus, in species where the covering tissues lose their chlorophyll prior to seed maturation, e.g., Hordeum murinum, then much of the phytochrome present should be in the Pfr form and so germination should occur readily in the dark. By contrast, in a species such as Capsella bursa-pastoris where the chlorophyll level in the surrounding tissue remains high, then the seed will receive a higher proportion of far-red light resulting in a higher proportion of the Pfr form being present. The seed will thus need light to convert Pr  $\rightarrow$  Pfr before it will germinate.

While there is no experimental evidence in the literature concerning a similar screening effect of light by seed coats during maturation it seems likely that this factor must play some part in determining light requirements, e.g., Chenopodium album seed testas transmit five times more far-red (768 nm) light than red (643 nm) light (Karssen, 1970b) and this species requires light for germination.

This all seems straightforward but there is some evidence to suggest that the situation is not always so simple. Arabidopsis thaliana race Estland responds to maturation under incandescent lamps by showing a high sensitivity to red light. The same treatment given to A. thaliana race BL-1 resulted in a high degree of dormancy and seeds were insensitive to red light (Hayes & Klein, 1974). In this case the seeds were not simply

responding to the state of the phytochrome system at dehydration, but, a positive increase in dormancy seems to have resulted from maturation under light with a high proportion of far-red light. It was also pointed out by Cresswell & Grime (1981) that the seeds which matured within covering structures that had lost their chlorophyll tended to be those that could germinate in the Autumn soon after harvest. The seeds with green covers tend to be small and form persistent seed banks. The high Pr level may enable them to remain dormant while buried.

1b) Photoperiod and light quantity

The photoperiod during seed maturation can affect dormancy markedly. Seeds of Aegilops kotschy produced seeds that were more dormant if matured under long days than under short days. The photoperiodic effects on germinability were exerted after anthesis (Wurzburger & Koller, 1976). Chenopodium polyspermum seeds were affected in the same way, i.e., less dormant when matured under short days (Pourrat & Jacques, 1975), and again germinability was determined in the first few days after anthesis. The response appeared to be genuinely photoperiodic and under phytochrome control as indicated by night-break experiments (Pourrat & Jacques, 1975; Kigel et al, 1977). Seeds of Chenopodium album could also be made to show long day germinability characteristics if given a short day photoperiod plus a night break (Karssen, 1970a). However in this case the night break effect persisted for a short time only and the germinability of the seeds reverted to a typical short day response.

The persistent effects of photoperiod during maturation in C. album appear to be due to long-term morphological changes. In C. album (Karssen, 1970a) dormancy was related to seed coat thickness which, in turn, was related to the photoperiod (long days resulted in thick seed coats and vice versa). However, in C. polyspermum there was no consistent correlation between dormancy and seed coat thickness or seed weight. In Amaranthus retroflexus (Kigel et al, 1977) seed matured under short days again showed less dormancy but again showed no relationship to seed coat

thickness or seed weight. Any differences were very small and inconsistent. It seems likely that the level of dormancy induced during maturation depends on the total amount of light. Seeds of A. retroflexus showed less dormancy when matured under a neutral density shading screen during short day photoperiods (Kigel et al, 1977). In Glycine max short days during maturation result in rapid seed filling at the expense of vegetative growth (Cure et al, 1982). This results in an early cessation of plant growth and therefore seed filling is achieved over a short period. In long day situations seed filling is extended over longer periods and a higher yield is obtained but the seed is also more dormant, suggesting that it is the longer period of seed maturation which allows higher dormancy induction.

There is some convincing correlative evidence for day length effects on seed coat morphology. In the desert species Ononis sicula (Gutterman, 1973; Gutterman & Heydecker, 1973) and Trigonella arabica (Gutterman, 1980/81) daylength affects seed coat colour, structure and permeability to water. The critical period is the last 8 days of seed maturation. Under short days both species produce brown seeds, with an undeveloped seed coat structure, which germinate immediately after contact with water. However, under long days, they produce impermeable, yellow seeds with maximum development of the seed coat structure. Such differences may be due to the different metabolism of phenolics. It has been hypothesised (Marbach & Mayer, 1974) that seed coat impermeability to water may result from the oxidation of phenolic compounds through catalysis of catechol oxidase.

When pods of Ononis sicula were covered in aluminium foil and the plants transferred from a short day environment to a long day one and vice versa, the effects of light on seed germinability and seed coat permeability were transmitted by the leaves and not directly by the seeds or the pods, (Gutterman, 1973). This is a principal difference between the effects of light quality and light quantity during seed maturation

in relation to subsequent germinability.

Some other species which have been shown to respond to different day lengths are Portulaca oleracea (Gutterman, 1974), Lactuca scariola (Gutterman et al, 1975), Lactuca sativa c.v. Grand Rapids and Carrictera annua (Gutterman, 1975).

In the fruits Cucumis sativus (Gutterman & Porath, 1975) and Lycopersicon esculentum (Gutterman, 1980/81) photoperiodic effects can be transferred to seeds from the fruit even when they are not on the mother plant. In overripe tomatoes held under short days germination may occur even within the fruit despite the inhibitory nature of tomato juice.

In every case mentioned so far seed maturation under short days has resulted in lower dormancy. However there is at least one exception. Seeds of Avena fatua become more dormant under short days than long ones (Richardson, 1979).

It cannot be ruled out that some environmental effects such as photoperiod are mediated through the mother plant via the transport of metabolites and plant growth regulators. Application of plant growth regulators during seed maturation can cause changes in the germinability of the produced seed. Applications of gibberellic acid could prevent the onset of dormancy in Avena fatua (Black & Naylor, 1959) and in Avena ludoviciana (Morgan & Berrie, 1970). In Pisum sativum gibberellins increased during the main phase of pod growth early in fruit development. GA<sub>29</sub> levels were unaffected by day length but GA<sub>20</sub>, GA<sub>19</sub> and other gibberellins accumulated more under short day conditions (Ingram & Browning, 1979).

Germinability of seeds from tomato fruits injected with ethephon under short and long day photoperiods were compared to non-ethephon treated controls. Seeds matured under short days with ethephon treatment gave the greatest germination. It was found that the fruit released more ethylene under short days than long days. Also short days-matured fruit

contained less inhibitors as shown by the fact that lettuce achenes germinated much better on half strength tomato juice taken from short day fruits (58%) than those taken from long day fruits (8%) (Gutterman, 1980/81).

## 2. Breaking of dormancy and promotion/inhibition of seed germination

### 2a) White light

The germination response to white light (here taken as daylight, fluorescent or incandescent sources which have not been altered spectrally) can be positive or negative depending on species or even batch of the same species. Seeds were termed either positively (light promotes germination) or negatively (light inhibits germination) photoblastic. However the situation is rather more complex than this; negative and positive photoblastism are actually different manifestations of the function of phytochrome.

Under continuous light many species show a promotion of germination (examples in Smith, 1975). Light is required to break dormancy through the action of phytochrome and this action may be required continuously, i.e., the seed will not respond to a single short exposure of light as is found in some cases, e.g., the classic Lettuce cv. Grand Rapids experiments. So seeds which require continuous light are those which need the repeated conversion of Pr to Pfr. In all cases the requirement for a continued presence of a high proportion of Pfr can be met by intermittent pulses of light. There is a requirement for a high proportion of Pfr throughout the germination process.

There are also seeds which are inhibited from germinating when placed in white light (examples in Smith, 1975). They usually germinate well in darkness and already contain a high proportion of Pfr in the freshly harvested seed, e.g. Amaranthus caudatus contains 25% Pfr (Kendrick et al, 1969) and Cucumis Sativus L. (Spruit & Mancinelli, 1969) contains 75% Pfr. These seeds are generally unaffected by a short

exposure to white light. However there are other species whose germination is promoted by a short exposure to light but is inhibited by further irradiation e.g. Oryzopsis miliacea (Negbi and Koller, 1964). In lettuce seeds germination could be inhibited by irradiating the seeds with prolonged far-red light after brief far-red irradiations had ceased to be effective in reversing the promotive effect of a red pulse, (Negbi et al, 1968). Such reactions have also been shown in Amaranthus caudatus (Kendrick and Frankland, 1969), Chenopodium album (Karssen, 1970b) and Sinapis arvensis (Frankland and Poo, 1980). Continuous far-red light will inhibit germination after escape from photoreversibility. The events which are blocked by prolonged far-red (or even white-light) are therefore those which occur late in the process of germination (Frankland, 1981) and it has been shown with Chenopodium album that photoinhibition can even act at 'stage 3' of germination when the radicle has penetrated the inner testa and endosperm (Karssen, 1970b). Phacelia tanacetifolia seeds with the radicles exposed could be prevented from further growth in white light if they were imbibed in 0.3M mannitol (Chen and Thimann, 1966), whereas growth in darkness was unaffected. So, then, it may be concluded that the photoinhibitory action of light during the later stages of germination is on radicle elongation.

Photoinhibition by white light is dependent upon both photon fluence rate and time. Since reciprocity does not hold for these photoinhibitory reactions they can be seen to have the characteristics of the high irradiance reaction (HIR). Inhibition of germination is linearly related to the logarithm of photon fluence rate in lettuce seeds (Gorski, 1975; Gorski and Gorska, 1979) and Sinapis arvensis (Bartley and Frankland, 1982). When exposed to very high fluence rates, such as full sunlight, seeds which were normally considered insensitive to light were inhibited from germinating (Gorski, 1975).

It has been suggested that this response confers a survival advantage on seeds by preventing their germination on the soil surface where the evapo-transpiration potential is high and there is a high risk of the seedling becoming desiccated before it can become established. More seeds of Lactuca sativa germinated on a cloudy day than in sunshine (Gorski and Gorska, 1979). It may not be entirely co-incidental that the peak of light attenuation by water vapour is the same as that for peak light absorption by Pfr, i.e. 725-730 nm.

The length of daily photoperiod also affects seed germination although it is not a truly photoperiodic phenomenon. The longer the photoperiod the lower the germination, e.g., Nemophila insignis (Black and Wareing, 1960) and Chenopodium spp (Cummings, 1963). In Nemophila menziesii maximum inhibition occurs in photoperiods longer than 16 hours but the shorter photoperiods could be made more inhibitory if given at higher irradiances (Cruden, 1974).

In some species photoinhibition of germination under white light occurs only when the seeds are stressed, e.g. the germination of Sinapis arvensis is reduced under osmotic stress or in low temperatures (MacDonald and Hart, 1981). In Phacelia tanacetifolia photoinhibition can be relieved by removing the endosperm layer covering the tip of the radicle, but, it can re-occur if the seeds are subjected to osmotic stress or high temperatures (Chen and Thimann, 1966). Exposing the radicle of Nemophila insignis seeds will also result in the reduction of effectiveness of photoinhibition and germination may occur (Chen, 1968).

The active parts of the spectrum which cause photoinhibition of germination are blue and far-red (Negbi and Koller, 1964). Photoinhibition caused by the far-red part of the spectrum is probably due to phytochrome only, but it is not clear how it functions. Action spectra of photoinhibition for several different species have been

calculated and all show peak photoinhibition in the 710-720 nm range; e.g., Amaranthus arenicola and Poa pratensis (Hendricks et al, 1968), Nemophila insignis (Rollin et al, 1970), Amaranthus caudatus (Frankland, 1976), Sinapis arvensis and Plantago major (Frankland and Poo, 1980). The shape of these action spectra are similar to those for HIR responses in seedlings. However, in seedlings the HIR operates in the same direction as a low energy red light response, whereas, in seeds the HIR operates in the opposite direction, i.e., germination is inhibited. This fact has been taken to indicate that the HIR process must be different in seed and seedling but this is not necessarily so. It has been shown that the HIR causing inhibition of germination acts on later processes in germination than the inductive reactions brought about by irradiation with a brief pulse of red light. There is, therefore, no reason why the LER and HIR actions of phytochrome should be expected to act in the same direction. This is not to say, however, that the HIR is the same in seed and seedling.

Light of the wavelength range 710-720 nm establishes photoequilibria of less than 0.1. In dual wavelength studies on the photoinhibition of lettuce seed germination, Hartmann (1966) found that when various far-red wavelengths, provided at constant photon fluence rate, were combined with 658 nm light provided at different photon fluence rates, then, maximum photoinhibition always occurred at photoequilibrium values calculated to be less than 0.1. He concluded that since this was close to the value of photoequilibrium established by 720 nm light then some value of photoequilibrium, less than 0.1, must be critical. Hartmann's model can be shown as below:

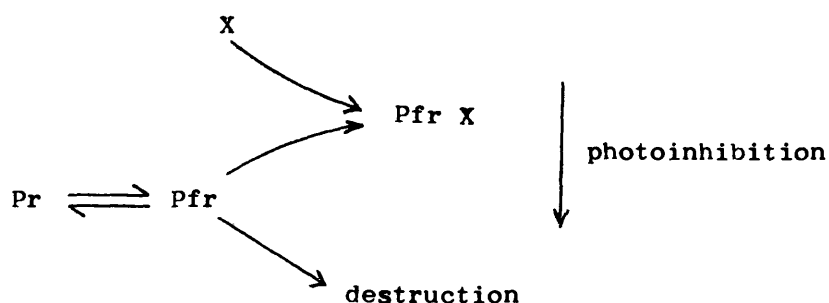

Hartmann's model depends on the concentration of a substance X, at steady state, with which Pfr combines to cause biological activity (and to become stable). If the concentration of X is low relative to Pfr concentration, then Pfr (and also P total) is rapidly denatured. This results in Pfr X being present for only a short time. On the other hand, if Pfr concentration is low (i.e., at low photoequilibria) then destruction is limited and Pfr X can exist for longer periods. Thus, according to this model, photoinhibition depends on competition between phytochrome action and destruction.

While similar results with dual wavelength experiments were found with N. insignis (Rollin et al, 1970) they also found that it was not only photoequilibrium which was important for inhibiting germination. Photoinhibition for a given pair of wavelengths, establishing a known photoequilibrium would vary depending on photon fluence rate. As presented in 1966, Hartmann's model could not explain dependence on photon fluence rate. He had to postulate that Pfr that had associated with substrate X was somehow more stable and so less susceptible to destruction. However, there was no evidence for this idea.

Dependency on photon fluence rate was also found in experiments with Poa pratensis and A. arenicola (Hendricks et al, 1968). They also found that in dual-wavelength experiments, regardless of the photoequilibrium established, any combination which included 720 nm light was inhibitory to germination. This led them to postulate the possibility of another photoreceptor (or form of phytochrome) with an absorption peak at 720 nm. Further, no evidence for Pfr destruction was found in A. caudatus (Kendrick et al, 1969) or in N. insignis (Rollin et al, 1970).

Along with the dependence of photoinhibition on photon fluence rate, and non-uniformity of the effect of photoequilibrium, the apparent stability of at least some fraction of the Pfr in seeds suggests that if

photoinhibition is mediated through phytochrome, then the cycling rate (H) between Pr and Pfr is also an important factor controlling photoinhibition.

In Sinapis arvensis, dose-response curves (where germination percentage is measured against the logarithm of the relative cycling rate) for mixtures of red and far-red light, establishing different photoequilibria, were parallel (Bartley & Frankland, 1982). Further, a theoretical action spectrum obtained by calculating the photon fluence rate required to give the value of H, at each wavelength across the spectrum, sufficient to produce half maximum germination of S. arvensis, agreed closely with other experimental action spectra for photoinhibition of seed germination. Bartley and Frankland (1982) concluded that the HIR photoinhibition of seed germination was in some way related to cycling rate of phytochrome and was antagonised by Pfr such that under light establishing high photoequilibria, then high cycling rates were required to inhibit germination. The two parameters, H and  $\phi$ , can be linked mathematically and used as a predictive relationship for germination under known light sources. Although Bartley and Frankland's (1982) scheme cannot be used to predict directly molecular mechanisms of phytochrome action in seeds it can be used to confirm parameters of the light environment which are involved in phytochrome mediated HIR photoinhibition of germination. In turn this can give clues to which areas of research into molecular mechanisms may prove fruitful. Deviations from predicted germination behaviour in white light based on fluence-response data from red and far-red mixture light sources, could indicate the involvement of photoreceptors other than phytochrome. Seeds with testas transmitting light throughout the 400-800 nm range should ideally be used.

While it is generally agreed that photoinhibition caused by the far-red part of the spectrum is mediated through phytochrome, there is

some doubt about the action of blue light.

Since phytochrome absorbs light from the blue waveband it is quite probable that at least some of the blue light activated photoinhibition is mediated through phytochrome. The effectiveness of blue light acting through phytochrome might, however, be expected to be quite low since light absorption and quantum efficiency are relatively low in blue compared to red light (Butler et al, 1964). Nevertheless, photoinhibition by blue light shows many of the characteristics of phytochrome HIRs such as dependence on photon fluence rate and failure of reciprocity (Mancinelli, 1980). In Lactuca sativa seeds blue light photoinhibition also acts on the later stages of germination as with the HIR (Gwynn & Scheibe, 1972). In a study on Nemophila insignis (Malcoste et al, 1972) the evidence concerning the blue light photoreceptor was conflicting. Data which support the view that blue light action is mediated through phytochrome is: 1) that the sensitive periods to both blue action and far-red action are the same; 2) that simultaneous irradiations with red and blue light, and far-red and blue light show interactions, and; 3) that for the same photon fluence rates a red and far-red light mixture and a blue light mixture, establishing similar photoequilibria, also give similar photoinhibition of germination. The first two findings are not surprising since photoinhibition late in germination is probably acting to inhibit the same process, possibly radicle elongation. The third finding may be coincidental. If it is the cycling rate of phytochrome which is important in determining photoinhibition (Bartley & Frankland, 1982) then blue light would be expected to be less inhibitory than the red/far-red mixture. Also, although the differences are probably not significant statistically, the red/far-red mixtures, while establishing slightly lower photoequilibria than the blue treatments, caused less photoinhibition. This could suggest that there is another inhibitory

blue light receptor acting alongside phytochrome.

Data which refute the sole action of phytochrome in the same set of experiments (Malcoste et al, 1972) were also found. Firstly, long term photoinhibition by blue light (as contrasted to that by far-red light) was found to be irreversible by red light in N. insignis. Secondly, the action spectrum for photoinhibition in the blue region bears a close resemblance to the action spectrum for Avena curvatura and other "cryptochrome" controlled processes. On balance the evidence of Malcoste and his colleagues (1972) is stronger in favour of a separate blue photoreceptor. The data which support a sole role for phytochrome is simply data for which the possible effects of two different photoreceptors cannot be separated. In Phacelia tanacetifolia a peak in the U.V. part of the spectrum for photoinhibition at 365 nm tended to confirm the involvement of some flavo-protein (Schulz & Klein, 1963).

In lettuce seeds (c.f. N. insignis) blue light was not able to induce dormancy and the seeds would germinate fully when transferred to darkness, even after 96 hours of blue light (Small et al, 1979a). Conversely far-red light of 48 hours duration was sufficient to cause dormancy. However the value of photoequilibrium established, which was lower in far-red than blue light, may be important.

There are, then, arguments for and against the involvement of a blue photoreceptor in photoinhibition of seed germination. However, although a separate effect of blue light is difficult to distinguish in some experiments the fact that results, indicating a blue photoreceptor, have been found is a positive reason for believing one may exist. There are several reasons why an effect mediated by a blue photoreceptor may not be found such as: 1) relatively high concentrations of phytochrome which may mask any separate blue light effects; 2) low concentrations, or absence of the blue photoreceptor (arguably the phytochrome system can cope with the detection of all light conditions relevant to modifications

of germination behaviour); 3) lack of transmission of blue light through the seed testa.

#### 2b) Vegetative Canopy Light

The effect of a vegetative canopy on the light environment below it is to reduce both photon fluence rate and the red/far-red light ratio ( $\lambda$ ) by the preferential absorption of the visible wavelengths (especially red and blue light) in comparison to the far-red region of the spectrum. This obviously has implications for the phytochrome system in plants and may be expected to affect the germination of seeds situated beneath vegetative canopies. Indeed it has been shown for many species that simulated or real canopy light conditions will reduce germination of seeds (Black, 1969; Vander Veen, 1970; Smith, 1973; Gorski, 1975; King, 1975; Frankland and Poo, 1980; Silvertown, 1980; Vazques-Yanes, 1980; Pons, 1983). Such a response has obvious survival advantages for the species since it will prevent the seed from germinating where the chances of seedling survival are small. The competition for resources such as light, water and nutrients would be very high under an established canopy. Such light conditions often induce secondary dormancy thus allowing the seeds to wait for a more opportune moment to germinate when the chances of successful seedling establishment are better. Prevention of germination by canopy light can also be important immediately after dispersal e.g. Cirsium palustre, allowing the seed to be incorporated into a seed bank rather than germinating in the Autumn (Pons, 1983). However, not all species tested have shown inhibition under canopy light. A survey of light promoted, light inhibited and light indifferent seeds has been made to compare their performance under canopy light (Gorski et al, 1977). Of 30 species of light requiring seeds, 29 showed reduced germination under canopy light. Nine out of 15 species with light inhibited seeds were adversely affected and 35 out of 80 light indifferent species were only

slightly affected. Of 27 chalk grassland species, only 17 were adversely affected by a leaf filter (Silvertown, 1980). Amongst annual/biennial species only Centaureum erythraea did not become dormant whereas a similar species from the same habit (Blackstonia perfoliata) showed 85% dormancy. This was taken to demonstrate the potential ecological significance of leaf induced dormancy in the maintenance of species diversity in grassland, i.e., they have different 'safe' germination sites allowing the co-existence of species in what appears to be a homogenous community.

The effectiveness of canopy light at inhibiting germination increases with the density of the leaf cover since this will result in a greater decline of  $\bar{z}$ . This has been shown with both real and simulated canopies. Seeds of Plantago major and Sinapis arvensis were germinated under canopies of Sinapis alba plants placed at different densities thus setting up a gradient of both photon fluence rate and  $\bar{z}$  (both being highest at the lowest density of S. alba plants) (Frankland and Poo, 1980). The germination of both species was stimulated by continuous white light but seeds placed below S. alba plants showed a steady (almost linear) decline in germination, as measured against photoequilibrium, down to a value of  $\phi = 0.2$  ( $\bar{z} = 0.1$ ) where both species showed no promotion of germination compared to dark controls.

Similar results were found with Cirsium palustre and Lactuca sativa seeds using a simulated canopy, consisting of a cross gradient of red and far-red sources, which gave a gradient of  $\bar{z}$  while maintaining a fairly even fluence rate (Pons, 1983). Cirsium palustre showed almost identical response to photoequilibrium as P. major and S. arvensis (Frankland and Poo, 1980) with germination declining to the level of dark controls at  $\phi \approx 0.2$ . L. sativa, on-the-other-hand, showed a sharp drop in germination from being nearly 100% at  $\bar{z} = 0.3$  to nearly 0% at  $\bar{z} = 0.15$ . The experiment with L. sativa was also carried out using

different densities of leaf cover and gave identical results. The sharp decline shown by L. sativa corresponds to the concept that germination only takes place if a threshold proportion or concentration of Pfr is reached. The rather more gradual decline of germination under light of decreasing  $\bar{z}$  ratios found with P. major, S. arvensis and C. palustre may be due to the greater variability of the seed population of these wild grown plants.

However the response is not simply one to Pfr concentration or photoequilibrium but also incorporates the HIR discussed in the previous section. Since it has been shown that an active part of the spectrum which is responsible for the HIR is far-red (e.g. Hartmann, 1966) then it follows that the effect becomes increasingly important with white light in which there is a high proportion of far-red, such as vegetative canopy light. This can be seen in an experiment with S. arvensis and P. major (Frankland and Poo, 1980) where seeds given only 1 hour of light with a  $\bar{z}$  of 0.1 showed a slight promotion of germination over dark levels compared with complete inhibition of germination which occurred with 16 hours of the same light.

#### 2c) Soil light

Soils contain vast numbers of viable seed which in most cases lie dormant until the soil is disturbed whereupon the land can be quickly colonised by the seedlings of weedy species. In many cases the stimulus which promotes germination is light, (Sauer & Struik, 1964); 0.5 seconds of daylight is sufficient for some species (Wesson & Wareing, 1969a). If the disturbance was made in darkness the number of species to emerge was much reduced. Since many of the species which respond to light during soil disturbance are those which show no light requirement for germination at harvest (or are even inhibited by light) it would appear that a light requirement was induced by burial in the soil, and further work suggested that this was so (Wesson & Wareing, 1969b).

There are many factors which will affect the germination of seeds buried in soil. Germination declines with depth of burial, e.g. Plantago lanceolata (Wesson & Wareing, 1969b), Abutilon theophrasti, Ipomoea purpurea, Brassica kaber (Holm, 1972) Senecio jacobaea (Van der Meijden and Van der Waals-Kooi, 1979), Plantago major and Sinapis arvensis (Frankland, 1981) where effects of the gas environment and water content of the soil may be expected to be greater and photon fluence rate markedly reduced. Seeds of P. lanceolata were inhibited from germinating when the water content of the soil was greater than 80% pot capacity (Wesson & Wareing, 1969b). Passing air through the soil allowed an increase in the germination of buried seed but this did not appear to be directly related to oxygen or carbon dioxide concentrations. Holm (1972) found that the seeds themselves produced volatile metabolites such as ethanol, acetaldehyde and acetone which inhibited germination if oxygen concentrations were low. It is interesting that both ethanol and acetone, as well as other anaesthetics, have been reported to stimulate the germination of Panicum dichotomiflorum (Taylorson and Hendricks, 1979) but presumably in conditions of higher oxygen concentration than those found in Holm's (1972) experiment.

Water content of the soil may also affect the induction of a light requirement by hydration effects on the phytochrome system within the seed. When the seeds imbibe water sufficiently to allow the dark reactions of phytochrome to occur then any Pfr present will revert slowly to Pr thus inducing a light requirement (Hsiao & Vidaver, 1973). They also found that at low seed water content (16-20%) the seeds did not lose light sensitivity but that in directly wetted seeds (40% water content) the seeds soon lost light sensitivity and developed secondary dormancy (Hsiao & Vidaver, 1970). However, the rate of loss of light sensitivity could be reduced by irradiating the seeds with red light to maintain high Pfr levels. Even though the treatment was insufficient

to allow germination (the seeds were not allowed to imbibe fully) the induction of secondary dormancy was slowed. This suggests the following scheme for seeds in soil. Initially the seeds have primary (or innate) dormancy which may be lost over the Winter months by vernalisation etc. If the seeds are then prevented from germinating a light requirement will be induced. If this light requirement is met then germination occurs and if not then the seed will develop secondary dormancy in preparation for the next season. Such a scheme is supported by Taylorson's work (1972) where he demonstrates cyclical changes in light sensitivity of buried seeds which correspond to the natural periods of germination. These cyclical changes of sensitivity may also allow seeds to respond to other stimuli such as diurnal temperature fluctuations (Thompson *et al*, 1977).

As mentioned, the light environment is important in determining the changes in dormancy patterns and controlling germination itself. It is, therefore, necessary to appreciate the changes in the light environment which occur beneath the soil surface. The most drastic change with depth is the reduction of photon fluence rate. In a study by Wooley & Stoller (1978) of a silty clay loam and a sand they found that less than 1% of incident light penetrated 2.2 mm at any wavelength between 350 nm and 750 nm, for ped sizes up to 1 mm. Even so it should be noted that 1% of Summer sunlight (in Britain) would be about  $20 \mu\text{mols m}^{-2} \text{s}^{-1}$ . This would be sufficient to saturate the germination requirements of most light-requiring seeds. Light quality is also altered but depends on the type of soil. Light quality changes are marked in sands, but not in soils, since light can pass through sand grains and in doing so light of shorter wavelengths tends to be scattered more than that of longer wavelengths. This results in a decrease in the red/far-red ratio with depth. In soils, light can only pass through the voids and therefore the light quality tends to remain unchanged. Water content has opposite

effects in sand and soil. Water causes increased transmittance through sand because there is a decrease in the number and sharpness of refractive index discontinuities. In soil, water causes a decrease in transmittance by reducing reflection between the peds (which do not transmit light) and also by causing ped swell and the dissolving, or suspension, of light absorbing materials in the voids.

The germination of seeds of Plantago major and Sinapis arvensis show a decline of germination with depth of burial (Frankland, 1981). Based on an estimate of 5 hours for the half life of thermal reversion of Pfr to Pr at 25°C it was calculated that within a few millimetres of the surface the rate of non-photochemical reversion of Pfr to Pr would exceed the photochemical conversion of Pr to Pfr. At 3 mm depth of a fine seed compost the estimation of photoequilibrium based on the red/far-red ratio was 0.48 whereas the actual value was probably about 0.16. Further, at 6 mm it was calculated that P. major should show no germination at all, although even at 8 mm a small percentage of germination, above the dark level, occurred.

Seeds of Senecio jacobaea were germinated in light under sand of ped size 0.1 - 0.6 mm (Van der Meijden and Van der Waals-Kooi, 1979). Germination was low on the surface, increased to a maximum at 1 mm depth and then showed a decline with depth down to 8 mm where germination levelled off at the same value until at least 16 mm. They concluded that the decline in germination with depth was due to reduced photon fluence rates which were insufficient to promote germination fully. They attributed the surface inhibition of germination to an effect of desiccation. Another possibility is that the surface seeds may be photoinhibited via the HIR.

Studies on the germination of seeds imbibed in chambers beneath screens of coarse sand (grains, 0.36 - 1 mm) have been made here at Leicester (Bliss, pers. comm.) In these experiments it is important

to note that the seeds are not actually buried within the sand (they are placed under a screen of sand or soil), so it is possible to keep all factors, other than the light environment, constant. Some species e.g. Chenopodium album and Galium aparine show peak germination beneath screens of soil about 2 mm thick, representing just below the soil surface. Surface inhibition appears to be due to high photon fluence rates ( $270 \mu\text{mols m}^{-2} \text{s}^{-1}$ ) causing photoinhibition. The decline in germination below depths of about 2 mm (where photon fluence rate is 6.1% of the incident level) appears to be related primarily to photon fluence rate rather than light quality effects. Seeds of Rumex obtusifolius are stimulated to germinate above dark levels at only  $0.007 \mu\text{mols m}^{-2} \text{s}^{-1}$  where dark reversion of Pfr to Pr should occur much more rapidly than photoconversion of Pr to Pfr ( $t_{\frac{1}{2}}$  for Pr to Pfr  $\approx$  48 hours). Amaranthus caudatus is a dark-germinating species which is strongly photoinhibited. The seeds show some photoinhibition to a depth of 4 mm.

It has been suggested that this response to photon fluence rate shown by small-seeded species may confer two survival advantages. Firstly, inhibition of germination on the soil surface by high photon fluence rate light would prevent the seed germinating under conditions of high evapo-transpirational stress where the seedling would have little chance of becoming established before it was desiccated. Cruden (1974) observed fully-imbibed seed lying beneath week-old seedlings following a rain storm. It appeared that in this instance light inhibited the germination of those seeds lying on the surface, while those that were in cracks in the soil germinated.

Secondly, it has been argued that the response of some seeds to germinate maximally just below the surface is also important. Light-sensitive seeds tend to be small and have rather limited food reserves so it is not only important that they do not germinate on the surface but also that they do not germinate at too great a depth. However this

may be an over-simplification since seed size may not be relevant to the requirements of the seedling because the size of the seedling to be achieved at emergence may be more important. In a field emergence trial seeds of cabbage, onion, carrot and lettuce (all small seeds) all show maximal emergence when sown at depths of 20 to 30 mm and some seedlings emerge from 80 or 90 mm depths (Heydecker, 1956). This shows, quite simply, that small seeds can have sufficient reserves to enable emergence from quite considerable depths of sowing. Another point to note is that other germination-stimulating factors such as diurnal temperature fluctuations will penetrate deeper into the soil than will light (Thompson et al, 1977)

### 3. Induction and Control of Secondary Dormancy

This section is concerned with the many factors which act together to control secondary dormancy in the seed, i.e., the induction and maintenance of secondary dormancy. In addition there are two extra parts towards the end of this section which lie outside the immediate confines of the experimental research of this thesis. These two parts are concerned with: i) membranes and dormancy, and ii) water stress and dormancy. Part i) is included to present some information about what is commonly considered to be the primary site of action for phytochrome, i.e., cellular membranes. Part ii) is included since at least some of the ecological significance of seed responses to light and phytochrome action is considered in terms of water stress, most particularly the HIR photoinhibition effect on seed germination.

When seeds are shed from the mother plant they generally possess primary dormancy, though not always (Cresswell & Grime, 1981). Depth of dormancy may vary even in seeds from the same plant. Release from primary dormancy may vary between species, e.g., the difference in changing patterns of dormancy, during burial, of a Summer annual (Polygonum persicaria - Karssen, 1980/81) and a Winter annual

(Veronica hederifolia - Roberts & Lockett, 1978). Secondary dormancy of the Summer annual is imposed during the high temperatures of Summer and is slowly released by the action of low temperature during Winter leaving the seed ready to germinate in Spring. Conversely secondary dormancy of the Winter annual is imposed during the Winter and released during Summer so that the seed can germinate in the Autumn. Primary dormancy is released in the same manner as secondary dormancy for both species. It is therefore clear that if a seed is inhibited from germinating at the appropriate time then the ensuing temperature changes will result in the induction of secondary dormancy. Indeed the resulting induced cyclical changes of dormancy may continue for several years (Karssen, 1980/81).

Seeds need not pass through a phase of non-dormancy when passing from a state of primary dormancy to a state of secondary dormancy (Esashi et al, 1983). Measurements of response to growth promoting substances and measurements of growth parameters showed an increase and then decline with increased pre-soak time indicating release of primary dormancy and induction of secondary dormancy without there being any stage in which seeds fully lost dormancy.

The cyclical changes in dormancy of buried seeds are mirrored by changes in Pfr requirement and light sensitivity (Taylorson, 1972). At the period of maximum sensitivity to light seeds of Barbarea vulgaris could be induced to germinate by 1 second of red light and seeds of Ambrosia artemisiifolia, Polygonum pensylvanicum, and Stellaria media could be induced to germinate by far-red light establishing only 2% Pfr. Taylorson (1972) postulated that changes in sensitivity to light were brought about by changes in total phytochrome concentration such that the concentration is highest at the time of maximum sensitivity, although he could provide no data to support this claim. The alternative would be a change in the sensitivity to Pfr itself.

In later work, Taylorson & Hendricks (1973) demonstrated that changes in sensitivity to light were not due to changes in phytochrome level since the germination response of secondarily dormant seed to light of different red/far-red ratios could be realised after a 5°C treatment to break dormancy. It was also suggested that the response to temperature changes may be due to the dependence of germination on order  $\rightleftharpoons$  disorder transitions of seed components, possibly some biophysical membrane effect (Taylorson & Hendricks, 1973). It is possible, therefore, that changes in the membrane state, rather than Pfr per se causes secondary dormancy. This hypothesis will be considered in greater depth later. Work by Duke and his colleagues (1977, 1978a, 1978b) agrees with Taylorson & Hendricks that dormancy is not under Pfr control per se. Duke et al (1977) proposed a model for variable sensitivity in dark-dormant seeds whereby dormancy is controlled by changing levels of a substance X, which can interact with Pfr, and speculated that this substance X is the primary site of action of phytochrome and may be a membrane or associated with membranes. Changing levels of substance X might come about if membrane organisation was changed, e.g., at different temperatures and water availabilities, perhaps by increasing or decreasing the availability of receptor sites. Duke's (1977) idea was supported by probit-log plots of seed germination which show parallel fluence-response kinetics despite the need for more light in some cases depending on the level of dormancy (Duke, 1978a). Similar results were found by Blaauw-Jansen & Blaauw (1976). Germination of Rumex crispus seeds in osmotica resulted in a reduced effectiveness of Pfr action but the reduced water content of the seeds had no effect on the slopes or saturation points of the fluence-response curves. Also the time during which the response of a portion of the seeds was still photoreversible by far-red light was increased by imbibition in osmoticum (Duke, 1978; Berrie et al, 1974; Loercher, 1974;

Hsiao & Vidaver, 1971). These results suggest that water potential has no effect on Pfr receptor sites but there is a direct effect on a reaction involving phytochrome; i.e., the Pfr - X interaction (Duke, 1978b). Duke concludes that low water content slows down the interaction between Pfr and X more than it inhibits the dark reversion of Pfr to Pr, and so the effect of pre-existing or newly-established Pfr is lost. This conclusion is supported by the results of Hsiao & Vidaver (1973) where lettuce seeds (cv. Grand Rapids) were allowed to develop secondary dormancy in a water-saturated atmosphere at 20°C in the dark prior to transfer to water for germination. Seeds incubated in darkness soon became dormant while those that were irradiated with red light at the beginning of the treatment, while still becoming dormant, became so at a slower rate. These results were not due simply to an effect of Pfr reversion to Pr since the effectiveness of red irradiations given after the treatments inducing secondary dormancy also decreased with time.

This type of secondary dormancy which occurs in darkness, and where the seeds are maintained at a temperature at which germination can proceed in light, is termed skotodormancy rather than thermodormancy since it is the fact that the seeds are in darkness which is determining that they are becoming dormant. This is, however, not necessarily a useful term since it implies that this type of dormancy is fundamentally different from others. Darkness, for a light requiring seed, can simply be thought of as another form of stress.

One treatment which can induce secondary dormancy is the use of supra-optimal temperatures (Vidaver & Hsiao, 1975; Roberts & Lockett, 1978; Bewley, 1980) with seeds showing greater dormancy as temperatures increase (Taylorson & Hendricks, 1973; Kristie et al, 1981; Rethy et al, 1983). Generally seeds are thought not to become dormant at low temperatures, i.e. less than 5°C (Taylorson & Hendricks, 1973) but it has been shown that dormancy can be induced at temperatures as low as

1.5°C after long periods, i.e., 12 weeks (Totterdell & Roberts, 1979). Indeed the role of light during stratification may have more to do with preventing induction of secondary dormancy rather than releasing primary dormancy (Totterdell & Roberts, 1979). By contrast, in Winter annuals, e.g., Veronica hederifolia, induction of secondary dormancy appears to be greater at low temperatures than at high temperatures (Roberts & Lockett, 1978).

Induction of secondary dormancy can occur under water stress whether by using saturated atmospheres (Hsiao & Vidaver, 1973) or by using osmotica (Loercher, 1974; Khan & Karssen, 1980; Karssen, 1967; Kahn, 1960).

Continuous or prolonged far-red irradiation can induce secondary dormancy (Blaauw-Jansen & Blaauw, 1976; Kendrick, 1976; Small et al, 1979b) as can the light filtered through a vegetative canopy (Stoutjesdijk, 1972; Gorski, 1975). Intermittent far-red irradiations are just as effective, e.g., a regime of 1 minute far-red light, 9 minutes dark cycles resulted in secondary dormancy induction equal to that caused by continuous far-red (Mancinelli & Borthwick, 1964). This was taken to indicate that phytochrome was acting through the LER phytochrome system. Brief far-red irradiations given to seeds can sometimes stimulate germination if the level of dormancy (i.e., Pfr requirement) is low (Taylorson, 1972) or if given at very low fluence rates to stimulate germination through the very low fluence response (VLFR) system (Blaauw-Jansen, 1976; Van der Woude, 1983).

Seeds appear to become secondarily dormant when held under anaerobic conditions (Vegis, 1964) in as much that a renewed light requirement may be seen for germination to occur (Ikuma & Thimann, 1964). However, anaerobic conditions may simply be inhibitory without inducing secondary dormancy since germination will occur when the seeds are returned to air and given light, e.g. with lettuce (Ikuma &

Thimann, 1964; Vidaver & Hsiao, 1975). Indeed the induction of secondary dormancy appears to require aerobic conditions. Dark or far-red light pulse treated lettuce seeds become fully dormant after 8 days of dark storage at 20°C in air, (Vidaver & Hsiao, 1974) requiring both a red light pulse and gibberellic acid treatment to induce germination. In anaerobic conditions, however, lettuce seeds will respond to either gibberellic acid or red light even after 10 days of dark storage (Vidaver & Hsiao, 1975). Also in lettuce seeds anaerobiosis opposes the temperature shift of germination which occurs when they are held at 25°C for 3 days in air (Karssen, 1980/81). Anaerobiosis prevents the development of secondary light requirement at constant temperature in seeds of Sisymbrium officianale. The secondary light requirement which can occur if seeds are held under anaerobic conditions appears to be a result of the ability of phytochrome to undergo both photoconversions and dark reversion in anaerobic conditions. The processes which lead to germination after light induction, on the other hand, do require oxygen. This is demonstrated by the fact that lettuce seeds cannot escape reversibility by far-red light while they are held in a nitrogen atmosphere (Ikuma & Thimann, 1964), but can when they are returned to air. Thus, while seeds are in anaerobic conditions, the oxygen requiring reactions needed for germination cannot occur yet Pfr may still revert to Pr. Consequently when the seeds are returned to air they require a second irradiation to induce germination although they cannot be considered to have secondary dormancy.

As mentioned above continuous or intermittent irradiation with far-red light can result in the induction of secondary dormancy. Equally, continuous irradiation with fluorescent white light or daily short red light irradiations during exposure to stress conditions (i.e., osmotic and high temperature) fully prevented subsequent inhibition in darkness and moreover, advanced the rate of germination of Chenopodium

bonus-henricus (Khan & Karssen, 1980). Osmotic stress induced secondary dormancy could be prevented in lettuce seeds by keeping the seeds in fluorescent white light (Berrie et al, 1974). Seeds of Betula papyrifera kept at 3°C for protracted periods lose the promotive effect of chilling on germination (Bevington & Hoyle, 1981). Red light could maintain the promotive effect of chilling but this could be reversed by far-red light. A 3 minute red pulse could prevent induction of secondary dormancy in osmotically stressed lettuce seeds and this was also far-red reversible (Kahn, 1960), indicating the involvement of phytochrome. Thus high Pfr levels in the seed during exposure to inhibitory conditions appears to oppose the development of light requirement and this leads to the conclusion that reversion to Pr of pre-existing or newly-established Pfr, by photoconversion or by dark reversion, is involved in the development of secondary dormancy in seeds (Khan & Karssen, 1980). On this basis then, it is possible to explain the inhibitory action of supra-optimal temperatures and water stress on the basis of the phytochrome state within the seed.

At high temperatures dark reversion of phytochrome occurs faster than at lower temperatures, e.g., in Amaranthus retroflexus Pfr reverts to Pr four times faster at 25°C than at 20°C (Taylorson & Hendricks, 1969). Thus at high temperatures any pre-existing Pfr or any Pfr that is formed by photoconversion or relaxation from intermediates will undergo dark reversion to Pr before the Pfr has time to act fully, so preventing germination and eventually resulting in secondary dormancy. The inhibition cannot be considered to be the result of an inability to germinate at high temperatures per se since if Pfr is permitted to act for a sufficient time by holding imbibed lettuce seeds for several days at 0°C, almost all germinate on transfer to 30°C even though they have been in darkness throughout (Roth-Bejerano et al, 1966). While low temperatures can allow Pfr to initiate the reactions leading to radicle

emergence often they are also too low to allow these reactions to proceed (Bevington & Hoyle, 1981). However different rates of phytochrome dark reversion of Pfr to Pr cannot explain fully all the effects of temperature. By means of treatments at 37°C it was found that Pfr action itself was inhibited by high temperatures (Scheibe & Lang, 1969). After the time required to escape from far-red reversibility at 20°C, lettuce seeds (cv Grand Rapids) held at 37°C still had sufficient Pfr present to promote germination when the seeds were returned to 20°C.

Experiments using shifts to higher temperatures promoted the germination of Rumex obtusifolius, Barbarea vulgaris, Barbarea verna and Lepidium virginicum (Taylorson & Hendricks, 1972a). Similar experiments with Rumex crispus (Taylorson & Hendricks, 1972c) showed that the effect could be enhanced by red light, or even brief far-red, and could be reversed by prolonged far-red light. These results indicate that dark germination induced by temperature shifts arise from the interaction of pre-existing Pfr with the temperature shift. Release from secondary dormancy of R. crispus seeds could be achieved by high temperature shifts or chilling at 5°C. Chilling at 5°C appeared to increase sensitivity to Pfr (Taylorson & Hendricks, 1973). The results show that loss of phytochrome is not involved in secondary dormancy since activity resulting from phototransformation of phytochrome could be realised by the temperature treatments. Also the responses to temperature suggested the dependence of germination on order  $\rightleftharpoons$  disorder transitions as noted previously. Later experiments on temperature shifts supported this view, suggesting that high temperature shifts and phytochrome interact at a common point in the chain of reactions leading to germination (Takaki et al, 1981). Both 10 minutes light and 10 minutes 35°C treatment stimulated the germination of Rumex obtusifolius (Hand et al, 1982). Fluence-response curves for the

reversal of both the red light pulse and the 35°C pulse by far-red light were quantitatively identical. To investigate this further they irradiated both the red light and 35°C treatments with 680, 700, 710 and 730 nm light sufficient to establish photoequilibrium. As expected 680 nm light did not alter germination of red light treated seeds, but it enhanced the germination of those seeds treated to the 35°C pulse. This demonstrated that germination induced by the 35°C shift was the result of increased sensitivity to pre-existing Pfr, and this was supported by the fact that the other 3 wavelengths resulted in decreased reversal of the stimulation of germination in the 35°C treatment as compared to the 10 minutes red light treatment. Hand et al, (1982) concluded that both Pfr and the 35°C pulse acted on membranes, or interacted with something associated with membranes, to initiate germination.

### 3a) Dormancy and membranes

Since 1967 when Hendricks and Borthwick first postulated the involvement of membranes in the primary action of phytochrome the literature pertaining to phytochrome and its association with membranes has become extensive. It is not my intention to make a detailed review of it here, but to present some examples of general evidence before moving on to a specific look at phytochrome controlled membrane effects in seed germination.

Tanada (1968) demonstrated a red, far-red reversible attachment of mung bean root tips to glass which he took to indicate changes in electrical potential at the plasmamembrane under control of Pfr associated with membranes. These findings were confirmed (Racusen & Etherton, 1975) and, later, Racusen (1976) was able to measure changes in potential across the plasmalemma of Avena coleoptile cells when depolarisation occurred due to photoconversion of Pr to Pfr. These changes in electric potential brought about through phytochrome action

may cause alterations in ionflux. One of the best characterised systems of changes in ionflux is to be found in the movement of legume leaves (Galston & Satter, 1976) which comes about due to  $K^+$  movement in the cells of the pulvini. They claimed that the  $K^+$  movement was a result of electrical changes brought about by phytochrome.

Movement of  $Ca^{2+}$  ions across membranes has also received some attention; e.g., the phytochrome controlled alteration of the rate of exogenous  $Ca^{2+}$  entry into Meugeotia cells (Dreyer & Weisenseel, 1979); and the red/far-red reversible accumulation of  $Ca^{2+}$  in oat mitochondria (Roux et al, 1981). However, a problem with making any conclusions about the results of ion-movement experiments is that detection of ion flux is usually recorded 3 to 5 minutes after the onset of irradiation. Detection of any earlier effects are thereby precluded making it difficult to conclude whether changes in ion flux are a consequence of direct or indirect effects of phytochrome on membrane properties.

A rather different approach by Haupt (1972) showed that the orientation of chloroplasts in the filamentous alga, Meugeotia, is under phytochrome control and that orientation with respect to the cell wall depended on the form (Pr or Pfr) that the phytochrome was in. Separation-dichroism studies (Haupt & Weisenseel, 1976) with polarised red and far-red light showed that phytochrome was associated with cell membranes.

There is a need to make in-vitro studies of modifying effects of phytochrome on membranes in order to monitor any rapid red/far-red changes. One of the more reproducible approaches to this problem was the study of the alteration of levels of gibberellins extracted from etioplasts in-vitro (Cooke & Kendrick, 1976; Evans & Smith, 1976a). Red light caused an increase in the amount of extractable gibberellins and this was far-red reversible, thus indicating the involvement of

phytochrome. Spectrophotometric evidence was also provided suggesting that low but physiologically important levels of phytochrome were associated with the etioplast envelope membrane (Evans & Smith, 1976b). In response to criticism of the etioplast purification techniques, Hilton & Smith (1980) produced a pure extract of intact etioplasts with which they confirmed earlier findings. Again, however, there is the problem of a lag time of several minutes before increases in gibberellins can be detected; a period during which, for example, some enzymatic activity may have occurred to cause the observed results.

During the mid 1970s many workers were attracted to the phenomenon of phytochrome pelletability since it seemed to indicate that phytochrome was associating with a specific receptor site on cell membranes. Irradiation with red light brought about Pfr dependent pelletability which was both in-vivo (e.g., Quail et al, 1973) and in-vitro (e.g., Marmé et al, 1973). The red light induced pelletability was not far-red reversible but would decay over several hours in darkness. The presence of a divalent cation (usually  $Mg^{2+}$ ) was required in order to observe the red light enhancement of pelletability. The binding of Pfr to the membrane fraction appears to be a rapid process. Indeed the half time of red induced pelletability found in-vivo experiments on oats and maize was only 2 seconds at 25°C (Quail & Briggs, 1978).

For a few years it appeared that in-vitro phytochrome pelletability studies might yield answers to the problem of the primary action of phytochrome even though there was no definite proof that membrane changes occurred or even that phytochrome was actually associated with membranes in situ. However, when Quail and Gressel (1976) revealed that degraded 31 S ribonucleoprotein material in the extracts from Cucurbita pepo used in in-vitro pelletability studies would bind Pfr this line of enquiry fell into disrepute. Nevertheless, in-vivo studies are still an interesting proposition and worthy of some attention.

Immunochemical studies of phytochrome movement showed that after treatment with red light Pfr aggregated to discrete loci within the cytoplasm (MacKenzie et al, 1978) although the loci do not appear to be associated with any particular cell organelle (Epel et al, 1980). The aggregation process was termed 'sequestering'. Sequestering and pelletability share similar kinetics which suggest that both represent the same process whatever that may be; it is at least a rapid, Pfr dependent reaction and as such is an attractive proposition despite the equivocal nature of the data. A physiological response which bore similarities to pelletability and sequestering response was found by Spruit (1980) whereby the response (chlorophyll production in bean seedlings) was induced by a 380 millisecond pulse of red light but could not be immediately reversed by far-red light. A dark period of several seconds ( $t_{\frac{1}{2}} = 3.2s$ ) was required before reversal of the response could be effected.

Interpretation of Spruit's (1980) data and the very low fluence response (VLFR) data of Blaauw-Jansen and Blaauw (1976) fitted well with Hendricks' unpublished hypothesis (see Vanderhoef et al, 1979). This postulated that Pfr receptor sites were rare and that once filled the phytochrome molecule would remain there (at least in the short term) despite photoconversion back to Pr. Thus a very short pulse of red light would allow the receptor sites to be filled and even far-red light would produce sufficient Pfr to saturate the receptor sites. In Spruit's (1980) experiment the half-time for Pfr receptor site filling is presumably 3.2 seconds. Thus far-red light given immediately after the red light pulse would have no effect, but a later (and necessarily higher fluence) far-red irradiation would be able to cause the photoconversion of the greater part of the receptor-site-bound sub-population back to Pfr and, therefore, reverse the response. The hypothesis also predicts that far higher doses of red light would be

required to repotentiate a given response after far-red reversal than to potentiate it initially. This occurs in the findings of Blaauw-Jansen & Blaauw (1976) and other experiments showing very low fluence response (VLFR) e.g., Mandoli & Briggs, (1981).

However, two more recent lines of evidence suggest that Hendricks' hypothesis is too simple. One is that it now appears that phytochrome is a dimer (Hunt & Pratt, 1980) which means that the pigment can exist in Pr:Pr, Pr:Pfr and Pfr:Pfr forms. The other line of evidence comes from in-vivo pelletability studies (Watson & Smith, 1982) where divalent cations are not used. Here the membrane-associated phytochrome, following saturating red light, consists of less than ten percent of the total phytochrome. Also this association is far-red reversible and is therefore easier to understand in terms of most phytochrome mediated responses. In etiolated, or far-red light treated, Avena coleoptiles 2 to 3% of the phytochrome is associated with the membrane pellet; increasing to about 8% after saturating red light. This is clearly seen at pH values above 7.5. At lower pHs larger amounts of phytochrome bind to the membrane pellet (being about 60 - 70% at pH 6.25) and this pelletability is largely irreversible. This raises the possibilities that the pH effect is similar to the effect of adding divalent cations and also that the physiologically important fraction of phytochrome is the small population which shows reversible binding at pH 7.5. Further work by Napier & Smith (cited in Whitelam, Napier & Smith, 1984) using the same system revealed that the amount of the red/far-red reversibly-bound-fraction of phytochrome remained constant over a wide range of pH. This red/far-red reversibly bound fraction (termed 'Association I' by the authors) also shows 3 more important characteristics :

1) induction of 'Association I' binding obeys the Bunsen-Roscoe law of reciprocity;

2) photoconversion of Pr to Pfr increases the amount of phytochrome

which is pelletable from dark-grown tissues by exactly three-fold;

3) a constant proportion of Pfr is maintained in the pelleted fraction as compared to the supernatant fraction.

The authors conclude that there is a small physiologically active fraction of the total cellular phytochrome (Association I) which photoreversibly associates with a membrane component which may in itself be intrinsically-associated phytochrome. The characteristics of the Association I pelletability suggest that for every Pfr molecule produced in the small fraction of phytochrome which is pelletable in darkness, two further Pfr molecules associate with the pellet from the soluble pool. The demonstration that phytochrome in vivo exists as a protein dimer (Hunt & Pratt, 1980) explains why Pr is also found in the pelletable fraction since a Pfr:Pr dimer should bind to the membrane receptor site as readily as a Pfr:Pfr dimer. A similar view has been taken by Van der Woude (1983) on consideration of the literature. Van der Woude places more emphasis on the results of VLFR experiments. He suggests that, as opposed to Napier's work (Whitelam et al, 1984), the phytochrome irreversibly associated with the membrane (to which more phytochrome binds after red light) is bound as a consequence of very low fluences as suggested by Hendricks (see Vanderhoef, 1979). The phytochrome would bind strongly with another receptor already in the membrane. This scheme requires that all the phytochrome involved exists as dimers, meaning that six phytochrome molecules are associated with each receptor site. Napier's view (pers. comm.) that the membrane receptor is intrinsically associated phytochrome is supported by his findings that this phytochrome remains bound despite treatment with a wide range of pH and monovalent cations, and can only be removed by complete disruption of the membranes with detergents. His plants were grown in complete darkness although extraction procedures were performed under dim green safelight which could have been sufficient to saturate

the VLFR. It is also possible that the phytochrome receptor in Van der Woude's (1983) scheme is capable of very strong binding with the phytochrome dimer and may also resist attempts to free the association.

Having said all this, however, it is important to note that both schemes are highly speculative. Furthermore, even if either is correct and the membrane component can be identified there will still be no proof of physiological relevance since there is no evidence to show that the membrane undergoes any change as a result of phytochrome association. Nevertheless, taken in consideration with the results from other sorts of experiments some of which do demonstrate membrane changes; e.g., bioelectric potential studies (Racusen, 1976), the recent developments in pelletability studies may have important consequences to the understanding of the primary action of phytochrome.

Finally, having considered the background of the phytochrome and membrane work we may move on to the more directly related work on seed germination and phytochrome controlled membrane effects. Unlike the work on chloroplast rotation or pelletability considered previously, the following work on seed membranes does not demonstrate any direct interaction between phytochrome and membranes. However, it has been possible to show that phytochrome can affect membrane changes.

The evidence for the involvement of membranes in phytochrome control of germination and dormancy has mainly come from the measurement of amino-acid leakage from seeds; the use of fluorescent probes in membrane preparations; and the effect of 'anaesthetic' compounds.

In 8 out of 10 species tested at temperatures between 15 and 40°C, increased amino-acid leakage occurred in the 30 to 35°C range, possibly reflecting membrane changes. Changes in germinability with temperature were related to the 30 to 35°C range in the 8 species exhibiting leakage, with germination decreasing at temperatures above 30°C (Hendricks & Taylorson, 1976). In the remaining 2 species no increase in amino-acid

leakage was observed in the 15 to 40°C range and germination increased up to 40°C.

Seeds of Setoria faberi were imbibed at 40°C, then given temperature shifts to lower temperatures. Fluorescent probes for membrane phase transition, and measurements of amino-acid leakage for S. faberi showed a phase change and an increase in amino-acid leakage when the temperature was raised through 32°C; this was associated with a decline in germination (Hendricks & Taylorson, 1978). In Amaranthus retroflexus a similar membrane transition was indicated but no amino-acid leakage occurred (Hendricks & Taylorson, 1978). The A. retroflexus seeds were given far-red light sufficient to establish a low level of Pfr. While no effect was seen on the germination ( $\approx$  5%) of seeds when far-red was given after the temperature shift, a marked effect was seen on those seeds irradiated before the shift. Shifts to temperatures lower than 30°C resulted in 80% germination but those higher than 30°C resulted in 5% germination; i.e., the same level as seeds irradiated after the temperature shift. These results indicate that the sensitivity of the seeds to existing levels of Pfr is increased by temperature shifts and that this is associated with the state of cellular membranes. The presence of Pfr may alter the membrane state allowing the reactions leading to germination to be initiated.

Further evidence for the interaction between Pfr and membranes comes from work on Barbarea verna and Lactuca sativa seeds (Hendricks & Taylorson, 1979). Seeds were imbibed at 20°C and then either irradiated with a short period of red light or left in darkness. The seeds were then given a 4 hour temperature shift. Above the temperature of membrane transition (about 30°C) both irradiated and dark imbibed B. verna seeds showed increased amino-acid leakage and a sharp decline in germination. Thus, prolonged periods above 30°C are deleterious to the germination of B. verna yet shorter periods (e.g., 64 minutes) of temperature shift up

to 40°C will promote germination. Therefore, at prolonged temperatures above 30°C, seeds may suffer due to the loss of amino-acids or some other effect due to a decrease in the organisation of the membranes, while short periods of membrane disorganisation (decreased viscosity) may result in higher sensitivity to Pfr action, so stimulating germination.

In L. sativa (Hendricks & Taylorson, 1979) there are 2 temperatures where there are increases in amino-acid leakage; one at about 28°C and the other at about 34°C. Dark treated seeds show inhibition of germination at about 27°C while red treated seeds show inhibition of germination at about 32.5°C. It therefore appears that phytochrome (or a phytochrome mediated reaction) is able to counteract the effects of the first phase of amino-acid leakage but not those of the second.

The occurrence of membrane transitions and related declines in germination in the region of 30 to 35°C is sufficiently common to suggest a general control mechanism (Hendricks & Taylorson, 1979). Prolonged periods at temperatures above 30 to 35°C often result in high amino-acid leakage and it is an attractive idea to believe that this effect may be partially responsible for induction of dormancy; a point that will be considered later.

While membrane transitions at 30 to 35°C may constitute a general control mechanism, it is not the only temperature region in which phytochrome control is affected by membrane phase changes. Two examples involving pre-chilling are considered here. Pre-chilling of lettuce seeds at temperatures lower than 18°C (maximal effect at 4°C) increases both the sensitivity of the seeds to low levels of Pfr, and the rate of potentiation of germination by phytochrome when the seeds are returned to a higher temperature (Van der Woude & Toole, 1980). The dependence of the rate of potentiation of germination on the pre-chilling temperature displayed a sharp inflection at 18°C, indicating a

physiological response to a membrane lipid phase transition. On the basis of the work of others Van der Woude and Toole (1980) claim that chilling causes a reversible increase in the proportion of unsaturated and short chain fatty acids in the membrane phospholipids such that the viscosity of the membrane is decreased. These changes are related directly to the duration of chilling and inversely related to pre-chilling temperature.

The second example involves Betula papyrifera seeds. The germination of B. papyrifera seeds at 18°C can be stimulated by 3°C pre-chilling or by red light (Bevington & Hoyle, 1981). The effectiveness of pre-chilling could be enhanced by prior treatment with red light and this was far-red reversible. The red light enhancement of germination declined sharply between pre-chilling temperatures of 5 and 7°C and reached a minimum at 12°C, however, the effect recovered as temperatures increased again. These results suggest a membrane phase transition at about 7°C below which the seeds were more sensitive to Pfr. At these low pre-chilling temperatures phytochrome action could occur but reactions leading to radicle emergence required higher temperatures. A temperature of 12°C appears to be the least favourable for seed germination since sensitivity to Pfr is low, dark reversion of Pfr to Pr is relatively high, and also the temperature is insufficient to allow the metabolic events following potentiation.

The third approach to the problem of phytochrome and membrane interaction in the control of germination is the use of organic solvents especially those with anaesthetic properties. Anaesthetic activity is thought to be due to alterations in membrane state.

Most of the work with anaesthetic effects on seeds germination has centred on ethanol, a naturally occurring and readily metabolised molecule. Dormancy of Panicum dichotiflorum caryopses can be broken by ethanol treatment at 35°C and this could be enhanced by short red light

treatment (Taylorson & Hendricks, 1979). Ethanol overcomes the dormancy of several other grass species, including Setoria faberi, in a similar manner. It is interesting that ethanol treatment is ineffective below 30°C and this is consistent with a membrane transition seen in the region of 30 to 32°C for S. faberi seeds (Hendricks & Taylorson, 1976, 1979). Evidence that ethanol acts by altering membrane properties, rather than through some metabolic effect, can be seen in the similar action shown by the more slowly metabolised compounds chloroform and ethyl ether. Also the similarity in action of ethanol, methanol, chloroform, ethyl ether and acetone, is in accord with their lipid solubilities. None of these compounds has any osmotic effect (Taylorson & Hendrick, 1979). The action of ethanol, chloroform and ethyl ether on Panicum capillare caryopses could be prevented by the application of pressure greater than 1 MPa during the period of exposure to anaesthetic (Hendricks & Taylorson, 1980), indicating that the ability to germinate is correlated with expansion at the site of anaesthetic action in a cell membrane.

By contrast to the grass species, seeds of Rumex obtusifolius are inhibited from germinating at 20°C in ethanol (Taylorson, 1984). This is not an effect of toxicity since if exposure to ethanol is delayed until 16 hours after a red light treatment then the seed can escape from the inhibitory effect. Also the rate of escape from ethanol inhibition roughly parallels the escape from far-red reversibility in water, indicating a possible effect on phytochrome. Ethanol prevents Pfr action but has no effect on photoconversions or dark reversion to Pr. The inhibitory effect of ethanol can be overcome by pretreatment at 10°C or a 2 hour shift to 40°C. Taylorson (1984) proposed that ethanol causes perturbations at a membrane which can prevent Pfr action in R. obtusifolius, even though ethanol may enhance phytochrome action in grass species. This may reflect some fundamental difference between the

phytochrome system in monocotyledons and dicotyledons.

Up to the present no single technique of looking at the association of phytochrome with membranes has been able to produce definitive evidence proving that the primary site of phytochrome action is at cellular membranes. Despite this, so many lines of evidence point to that conclusion that the theory is generally accepted.

### 3b) Water stress and dormancy

Seeds subjected to water stress are inhibited from germinating and may become dormant as has been mentioned previously. Two possible causes of this, which involve phytochrome, are: the lack of hydration for biochemical pathways to proceed; and, effects on the growth potential of the embryo.

While limited photoconversions of phytochrome between various intermediates and Pfr or Pr can occur in seeds with very little water content (see review, Kendrick & Spruit, 1977), full photoconversion from Pr to Pfr (and vice versa), and also dark reversion, require higher levels of hydration since conformational changes in the protein structure of the phytochrome molecule are involved.

Imbibition rate of Amaranthus retroflexus seeds depends on temperature (Taylorson & Hendricks, 1972b). The time required for apparent complete rehydration of phytochrome (as gauged from germination experiments) and the uptake of 17 to 19% water corresponds closely at the 3 temperatures studied; i.e., 24 hours at 10°C, 12 hours at 20°C, and 3 hours at 35°C. However, there is no specific value of water content when phytochrome becomes fully photoconvertible in both directions (Berrie et al, 1974), implying that the molecule is hydrated gradually. Lettuce seeds were held at controlled water contents and irradiated with red or far-red light (Hsiao & Vidaver, 1970). The seeds were then transferred to free water to allow germination to occur. It was found that the responses of the seeds to the red or far-red light depended on

the percentage value of the water content up to 16%. Germination of dry-treatment seeds was unaffected by either wavelength. With 11% water content, red light treated seeds germinated maximally while far-red irradiated seeds showed no effect compared to dark controls, indicating the different conversion pathways of Pr to Pfr and Pfr to Pr. In seeds with 16 to 20% water content, escape from far-red reversibility did not occur, at least in the 24 hour period tested, whereas seeds with 40% water content did escape from reversibility. This indicates that relatively high water content is required for the Pfr initiated processes to occur and also for dark reversion of Pfr to Pr. By controlling water content persistent potentiated responses to light could be induced in seeds with water contents much below those required for germination itself (Hsiao & Vidaver, 1971).

Incubation of lettuce seeds in 0.3M mannitol allows sufficient water uptake to make seeds fully sensitive to red light but germination is only possible when the osmotic potential is lowered (Loercher, 1974). Seeds in 0.3M mannitol escaped from far-red reversibility slower than those in water. Fifty percent of the seeds in 0.3M mannitol could still be reversed when all the water imbibed seeds had escaped and nearly 100% of seeds in 0.6M mannitol remained sensitive to far-red light. Again this shows that hydration levels higher than those required for phytochrome photoconversions are necessary to allow germination. Obviously a range of water contents exists in which there is insufficient hydration to allow metabolic reactions leading to germination but sufficient to allow appreciable dark reversion of any pre-existing or newly established Pfr. Without Pfr the seeds will gradually become dormant. However, the inability to germinate is not simply due to the lack of Pfr since responsivity to red light also decreases after prolonged incubation (Hsiao & Vidaver, 1973). As has previously been mentioned, however, treatment with intermittent or continuous red light

during inhibitory osmotic or saturated atmosphere incubation will prevent induction of secondary dormancy by maintaining a high Pfr level (Khan & Karssen, 1980).

Apart from the direct effects of hydration on the phytochrome system there is also substantial evidence that control of dormancy lies in the balance between the restrictive external seed layers and the 'expansive force' of the embryonic axis. Scheibe and Lang (1965) found that irradiation of lettuce seeds with red light resulted in an increase of growth potential of the embryo enabling it to overcome the osmotic restriction imposed by a 0.46M mannitol solution. The inhibiting effect of light on the germination of Phacelia tanacetifolia seeds is overcome by removing the tip of the endosperm over the radicle (Chen & Thimann, 1966), however, immersion in solutions of high osmotic potential reinstates the light sensitivity.

Similar effects were found for seeds of Syringa spp. (Juntilla, 1973) where the growth potential of the embryos, measured as their ability to germinate in osmotica, was increased by chilling and gibberellic acid treatment. Chen and Thimann (1966) ascribed dormancy as a balance between mechanical constraint by the endosperm and the 'expansive force' of the embryo.

Determination of the water potential of lettuce embryos germinating in osmoticum showed that the water potential of red light treated embryos were lower than dark treated embryos, the difference being equivalent to the potential of 0.3 molal mannitol solution (Nabors & Lang, 1971a). This is similar to the force necessary for radicle penetration of seed coats which, as measured directly, was equivalent to the water potential of 0.16 to 0.38 molal mannitol. Therefore it appears that red light acting through phytochrome induces, in photodormant lettuce seed, a decrease in water potential equal to that required for germination, although this is unlikely to be the primary

effector of growth.

When the lettuce embryos are germinated in water, rather than osmoticum, their water potential is the same in both light and dark treated seeds, but the light treated embryos elongate much more rapidly (Nabors & Lang, 1971b). This suggests that in water the extra potential induced by red light is not allowed to accumulate but is rapidly translated into growth. A decrease in water potential below zero to -0.1 molal mannitol equivalent is quickly adjusted upwards through growth.

As has been discussed already the induction of secondary dormancy at supra-optimal temperatures has been associated with the leakage from cells of amino-acids (Hendricks & Taylorson, 1979). This then appears to fit well with the idea that escape from dormancy is due to an increase in growth potential of the embryo since if amino acids were leaked out, presumably along with other solutes, then this would bring about a decrease in growth potential by causing a rise in water potential within the embryo cells.

Photo-dormant lettuce seeds were incubated in 0.5M mannitol to prevent germination (Nabors et al, 1974). Under these conditions red light induced extensive degradation of proteins and a moderate degradation of lipids in the cortical cells of the radicle 24 hours after treatment.

Red light given to lettuce seeds (cv. New York-SIS-improved), also incubated in mannitol (0.3M) to prevent germination, caused an increase in the amount of free amino-acids accumulated in the embryonic axes as measured 30 hours after treatment (Takeba, 1980). Analysis of the free amino-acids suggested that they were the product of storage protein degradation. The increase in free amino-acids was far-red reversible and also varied depending on the period of imbibition prior to red light treatment. Germination in response to red light, given at various times during imbibition, was closely related to the amount of free amino-acid

accumulation in the axes. It was therefore concluded that the increase in free amino-acids was the cause of growth (Takeba, 1980), possibly due to the resulting lowering of the water potential. However there is evidence that simple alterations of the water potential of the embryo by leakage of amino-acids and degradation of proteins and lipids etc. is insufficient to explain the differences in growth potential between red and far-red irradiated treatments. Indeed changes in ionic concentrations of the cells may be more important.

Carpita et al (1979a) found that the growth rates of lettuce embryonic axes from both red and far-red light treatments could be equalised in solutions of poly-ethylene glycol (PEG) 4000 with an osmotic potential difference of 3.4 bars, i.e., the same rate of growth was obtained for red irradiated embryos in osmotic potential of -5 bars and for far-red irradiated embryos in -1.6 bars. Although the water potential differential remained constant during the growth of the axes, the osmotic constituents of the red light treated embryos became more diluted than those of the far-red irradiated embryos. Thus, since water potential is constant, the difference between the two treatments indicates that the greater reduction of the osmotic potential in the red treated axes must be accompanied by greater wall loosening of their cells in order to maintain the same growth rate as in the far-red irradiated embryo. In other words, pressure potential is greater in the red light treated axial cells. The water potential required for radicle growth is therefore obtained by a combination of osmotic potential and pressure potential (Carpita et al, 1979a). It was suggested above (Nabors et al, 1974; Takeba, 1980) that the increase in growth potential might arise from red light induced protein and lipid degradation, and accumulation of free amino-acids. However, Carpita et al (1979b) have shown that while the onset of axial growth is associated with high metabolism of storage materials, there is no

difference between red and far-red light treated seeds when the osmotic potential of the external medium is adjusted to give equal growth (i.e., 3.4 bars difference). This shows that these metabolic changes arise as a result of growth and are not under immediate phytochrome control. By contrast, red light treated axes showed enhanced accumulation of  $\text{Na}^+$  and  $\text{K}^+$ . Red light treated axes also showed an increase in  $\text{K}^+$  uptake and  $\text{H}^+$  efflux when potassium salts were introduced into the incubation medium. The movement of these two ions may have great importance on the water potential of the cells. Potassium ion accumulation will tend to lower the osmotic potential, while  $\text{H}^+$  ion efflux may cause loosening of the cell wall structure thereby lowering the pressure potential and thus facilitating cell extension. Carpita et al (1979b) speculated that phytochrome may be functioning by stimulating a proton pump which, in whole dormant seeds, would initiate water potential changes allowing the embryos to overcome the mechanical restraint of the surrounding seed layer, resulting in germination. This idea, therefore, supports the concept of phytochrome being associated with membranes and that phytochrome activity is closely linked with the state of the membrane.

In summary, seeds unable to germinate in conditions which are otherwise ideal for germination, are said to be dormant. Both the induction and maintenance of dormancy can be controlled by phytochrome. Induction of secondary dormancy can be prevented by a maintenance of high levels of Pfr, and Pfr appears to act by altering the biophysical state of membranes such that the necessary biochemical reactions required to maintain a high growth potential in the embryo can proceed. This is not to say, of course, that all dormancy is imposed in the embryo, or by processes controlled or influenced by phytochrome, but there is not room to consider these aspects here.

## AIMS OF THE PROJECT

The purpose of the project was to study germination responses to light conditions which may be found in the natural environment and to try to present an overall picture of the part that phytochrome might play in the survival strategies of plant species with light sensitive seeds. Some specific questions which have arisen from studying the background literature and which are relevant to the scope of the project are set out below.

The prolonged irradiations which cause photoinhibition of seed germination show activity in the red and far-red, and also in the blue wavelengths. These spectral effects need to be characterised and it is important to know what modifying effects on the light (quantity and quality) might be brought about by the seed's covering structures.

Photoinhibition of seed germination by prolonged irradiation appears to have the characteristics of the HIR of phytochrome in that the action spectra (in the red and far-red part of the spectrum) are similar to those for other physiological responses. It has been suggested that the HIR for seed germination is a special case since its action is opposite to the red induced LER which promotes germination. Germination is, of course, the result of many different processes and reactions; therefore, is the distinction of this HIR of any value on such a basis?

HIR photoinhibition is reported to be increasingly effective at high photon fluence rate and low photoequilibria. The high photon fluence rate component appears to be associated with rapid cycling of phytochrome and the effectiveness of the phytochrome cycling is enhanced at low photoequilibria. Two questions arise:

1. How might cycling rate (H) cause photoinhibition of seed germination? Is H causing photoinhibition by in itself being inhibitory or causing the production of inhibitory substances; or, is it

interrupting the dark processes which lead to germination?

2. What part does the detection of red/far-red light ratios play in the HIR? Is the maintenance of low photoequilibria important simply because it combines with the effects of high fluence rate to cause an increase in H, or, is photoequilibrium itself important in controlling the germination response?

Photo inhibition of germination by blue light has also been demonstrated although it is not clear whether a separate blue light absorbing pigment to phytochrome is involved. Is it, then, possible to separate the effects of blue light on the phytochrome system from those of a separate blue light photoreceptor? What consequences would the distinction of a separate blue light photoreceptor have on the understanding of photoinhibition of seed germination?

The depth of induction of primary dormancy is increased by low photoequilibria and by high photon fluence rates, the same conditions which are responsible for photo inhibition of germination. The question arises: is the induction of secondary dormancy caused by similar light conditions? If so, does photoinhibition lead to secondary dormancy by cause and effect, or, does photoinhibition simply allow secondary dormancy to develop in conditions which would otherwise support germination, i.e., moisture, optimum temperatures etc. In other words, can light conditions causing HIR photoinhibition determine the depth of secondary dormancy, or, will secondary dormancy always develop at the same rate regardless of light conditions.

It is hoped that answering these questions might lead to a better understanding of the role of light in the survival strategy of plants during the seed production, dispersal, germination stages of the life cycle.

## MATERIALS AND METHODS

### 1. Light sources and their measurement

#### a) Light sources for controlling light quality

The natural environment regarding light quality was simulated using 4 pieces of equipment maintaining a temperature of  $20 \pm 1^\circ\text{C}$  or better.

##### i Zeta cabinet (see Heathcote et al, 1979)

The Zeta (3) cabinet is a growth cabinet divided into four compartments each with a floor area of about  $0.25\text{m}^2$ . Each compartment is illuminated by 4 x 65/80 W fluorescent tubes to provide a constant level of photosynthetically active radiation (PAR) of about  $40 \mu\text{mol m}^{-2} \text{s}^{-1}$ . In addition each compartment (except No. 1) has supplementary far-red added such that compartments 2 to 4 have an increasing amount thus giving lower red/far-red quantum ratios (3) and thus low photoequilibria ( $\phi_c$ ) as calculated from an equation multiplying the spectral photon distribution (s.p.d.) of the light source by the photoconversion cross-section of phytochrome (see section 1.d)

The far-red light sources were achieved by filtering incandescent light through a far-red filter (initially a red and a green sheet of perspex but subsequently with a single sheet of "far-red perspex" supplied by West Lake Plastic Co., U.S.A.). The far-red perspex gives a much better far-red source with a good cut off at just below 700 nm.

The light sources for the supplementary far-red are:

cabinet 2 , 4 or 8 x 150W tungsten bulbs, clear

cabinet 3 , 4 x 500W tungsten halogen (Thorn.)

cabinet 4 , 8 x 500W tungsten halogen (Thorn.)

Spectra for the zeta cabinets are shown in figures a : 1 and a : 2.

##### ii Modified fluorescent tube lighting bank (fig. a : 3)

The top was cut out of a fluorescent tubes lighting bank and then two water baths through which a cross-flow of water could pass were

fig. a : 1

Spectral photon distributions for the four compartments of the "zeta cabinet" when the far-red light filter comprised of a red and a green sheet of perspex.

f.s.d. of 10 represents:

$$\begin{aligned} 4.04 \times 10^{-1} \mu\text{mol} \cdot \text{m}^{-2} \cdot \text{s}^{-1} \cdot \text{nm}^{-1} \text{ in } \mathcal{Z} \text{ cab. 1} \\ 4.00 \times 10^{-1} \mu\text{mol} \cdot \text{m}^{-2} \cdot \text{s}^{-1} \cdot \text{nm}^{-1} \text{ in } \mathcal{Z} \text{ cab. 2} \\ 4.68 \times 10^{-1} \mu\text{mol} \cdot \text{m}^{-2} \cdot \text{s}^{-1} \cdot \text{nm}^{-1} \text{ in } \mathcal{Z} \text{ cab. 3} \\ 8.74 \times 10^{-1} \mu\text{mol} \cdot \text{m}^{-2} \cdot \text{s}^{-1} \cdot \text{nm}^{-1} \text{ in } \mathcal{Z} \text{ cab. 4} \end{aligned}$$

fig. a:1

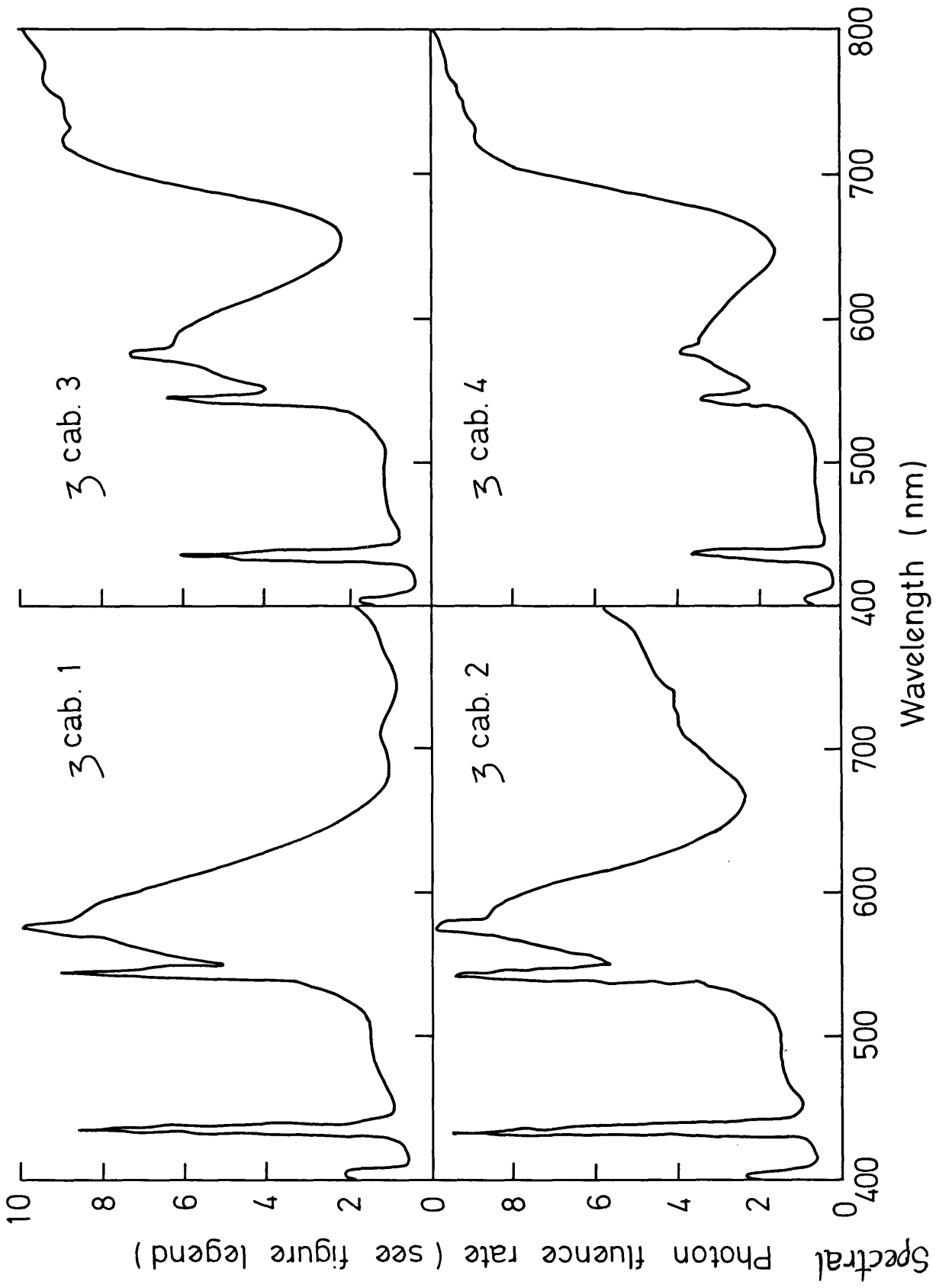

fig. a : 2

Spectral photon distributions for the four compartments of the "zeta cabinet" when the far-red light filter comprised of a sheet of far-red perspex

f.s.d. of 10 represents:

- 4.48 x 10<sup>-1</sup> μmol m<sup>-2</sup> s<sup>-1</sup> nm<sup>-1</sup> in 3 cab. 1
- 4.33 x 10<sup>-1</sup> μmol m<sup>-2</sup> s<sup>-1</sup> nm<sup>-1</sup> in 3 cab. 2
- 8.07 x 10<sup>-1</sup> μmol m<sup>-2</sup> s<sup>-1</sup> nm<sup>-1</sup> in 3 cab. 3
- 1.58 μmol m<sup>-2</sup> s<sup>-1</sup> nm<sup>-1</sup> in 3 cab. 4

fig. a:2

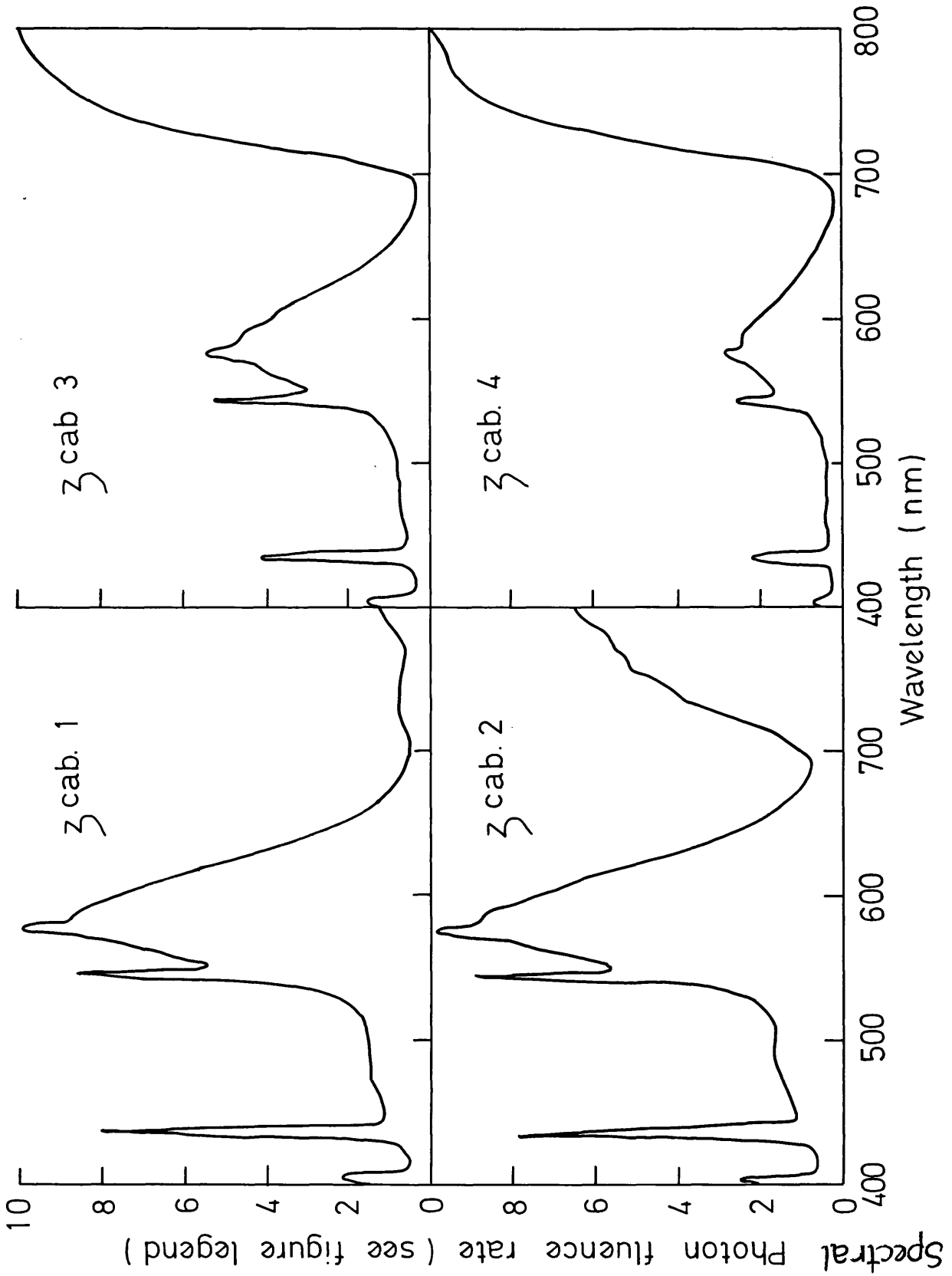

fig. a : 3

)  
Arrangement of modified fluorescent tube lighting rack

fig. a : 5

Arrangement of zeta-gradient

fig. a : 3

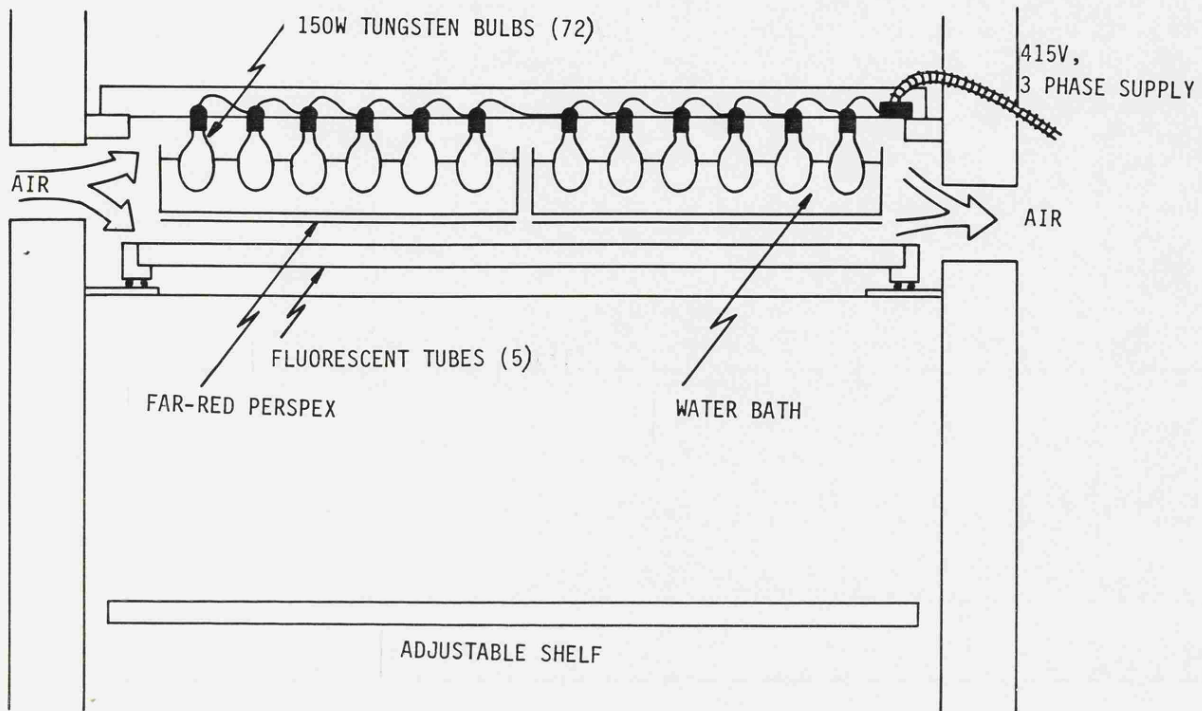
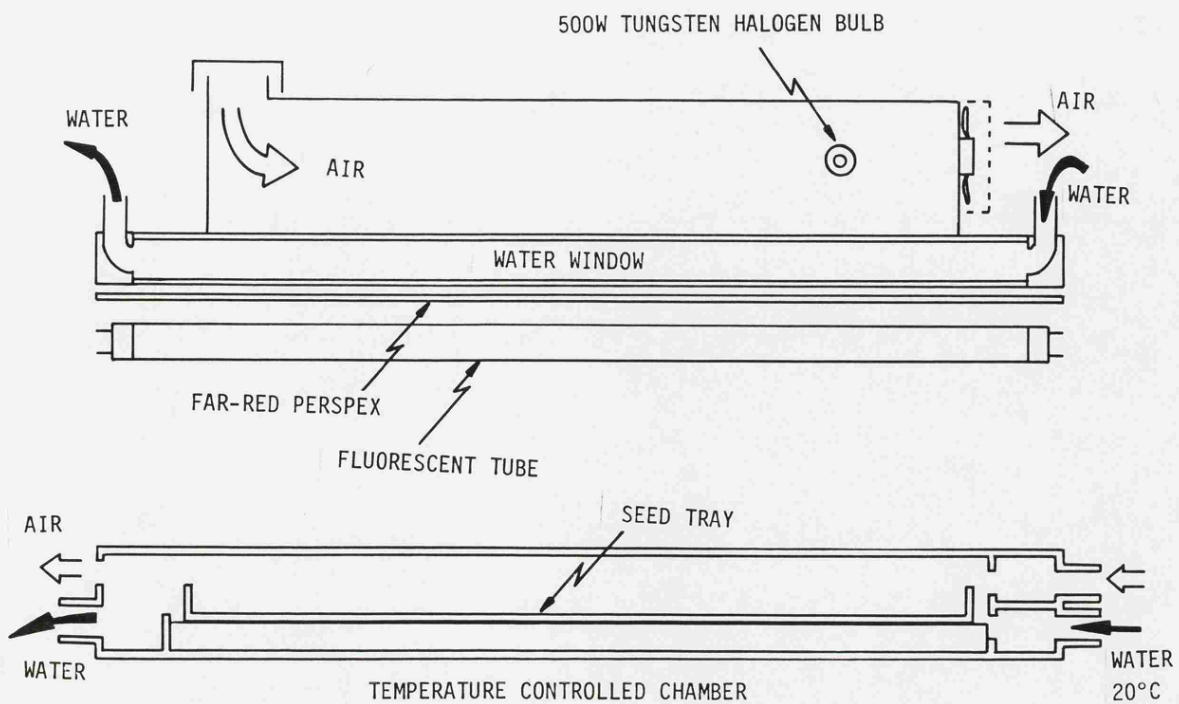

fig. a : 5



installed over a layer of far-red perspex. 72 x 150W clear light bulbs were wired up to a 415 V, 3 phase electricity supply such that 1, 2 or 3 sets of 24 lamps could be used while still providing even illumination in each case. The number of fluorescent tubes (150 mm 65/80W warm white) could be varied to suit the required light conditions and photon fluence rate could also be altered by using the adjustable shelf. A typical light spectrum is shown in fig. a : 4a.

The rack carrying the tungsten bulbs was seated so that the bulbs dipped into the flowing water to prevent overheating. Safety mechanisms included temperature, short circuit and earth leakage cut out switches and the use of brass light bulb holders to avoid the dangers of corrosion which occur with conventional "Bake lite" items under such conditions of heat and humidity. The light bulb rack could be raised (automatically switching off power) for periodical cleaning of the water baths and replacement of failed light bulbs.

### iii Zeta gradient (fig. a : 5)

A gradient was built to detect a more precise relationship between germination and light quality. Two 600mm 40W fluorescent tubes were used to provide an even PAR with a photon fluence rate of  $50 \mu\text{mols m}^{-2} \text{s}^{-1}$  along a distance of 13 inches. At one end of the apparatus a 500W tungsten halogen bulb (Thorn EMI Lighting Ltd.) was used to create a gradient of 3. The light from this bulb was filtered through a water window and one layer of far-red perspex. For spectrum, see fig. a : 6.

A separately cooled chamber was used to seat a tray in which thick blotting paper was placed to be used as an imbibition medium. Thirteen 2.5 cm by 6 cm sections were marked off on the blotting paper such that the light conditions in the centre of each were known. The tray was cooled by floating it in water flowing from a cooling water bath. Air was passed gently over the seeds to try to reduce their effects on each

fig. a : 4

Typical spectral photon distribution from modified fluorescent  
tube lighting rack

a - near the top

b - beneath neutral shading material

fig. a : 4a

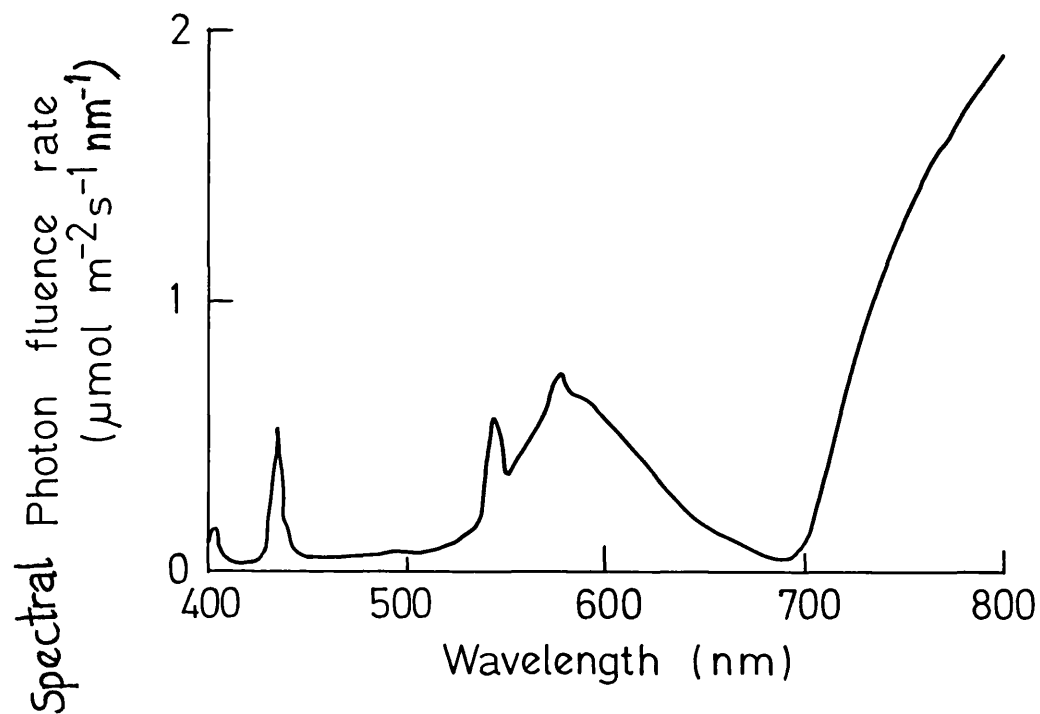
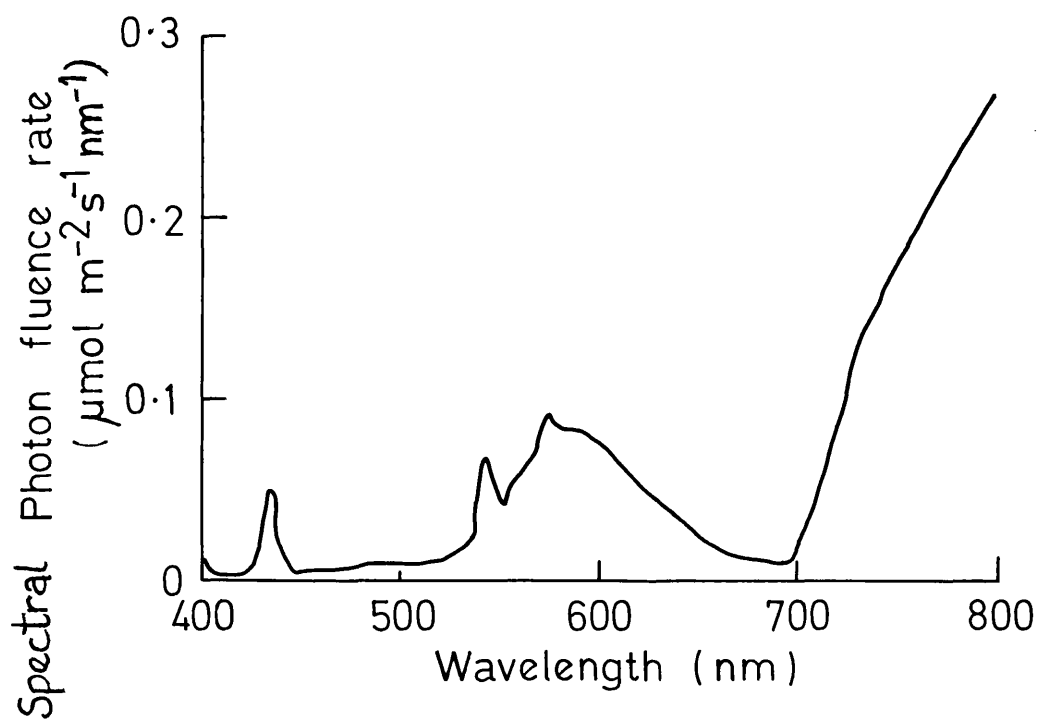

fig. a : 4b



other although any substance that diffused through the water in the blotting paper could not be controlled.

iv Fisons Growth Cabinet  $\zeta$  gradient

Two Fisons growth cabinets (model 2340 G3) which are modified to contain far-red light sources. In the cabinet used the far-red source comprised twenty four 500W tungsten halogen bulbs filtered through water windows and a layer of "far-red perspex". By switching on the far-red source at one end (twelve bulbs) only a gradient of  $\zeta$  could be produced sufficient to establish a range of  $\phi_c$  from 0.25 to 0.5 with a PAR of  $45 \mu\text{mols m}^{-2} \text{s}^{-1}$ . For spectra, see fig. a : 7

b) Light sources for controlling light quantity

i Fluorescent White Light (WL)

Light quantity experiments were mainly done using fluorescent WL and so any standard growth cabinet could be used where the temperature could be maintained at  $20^\circ\text{C}$ . Adjustment of photon fluence rate was achieved by varying the number and power of fluorescent tubes and the use of bleached muslin to shade the treatments without significantly altering the spectral properties of the light source (N.B. where supplementary far-red light is used then the proportion of far-red in the light increases gradually with more layers of muslin).

Light tight metal tins of 4 inches diameter (Delapak Ltd.) were used to allow short photoperiods and intermittent irradiations.

ii Fluorescent white light with supplementary far-red

For altering the photon fluence rate at low photoequilibria the modified lighting bank (see 1. a) ii) was used with its adjustable shelf height. Additional control was achieved with a sheet of green-house shading material called "Norplex" (Pilic Productions, Northwich, Cheshire) which had a minimal effect on light quality although the  $\zeta$  value of any far-red enriched light source was slightly lowered. For spectrum, see fig. a : 4b.

fig. a : 6

Spectral photon distributions for the 13 sections of the "zeta gradient". Photoequilibrium ranges from 0.372 to 0.594

fig. a : 7

Spectral photon distributions for 7 points along the gradient of  $\zeta$  in the Fisons growth cabinet. Photoequilibrium ranges from 0.237 to 0.485

fig. a : 6

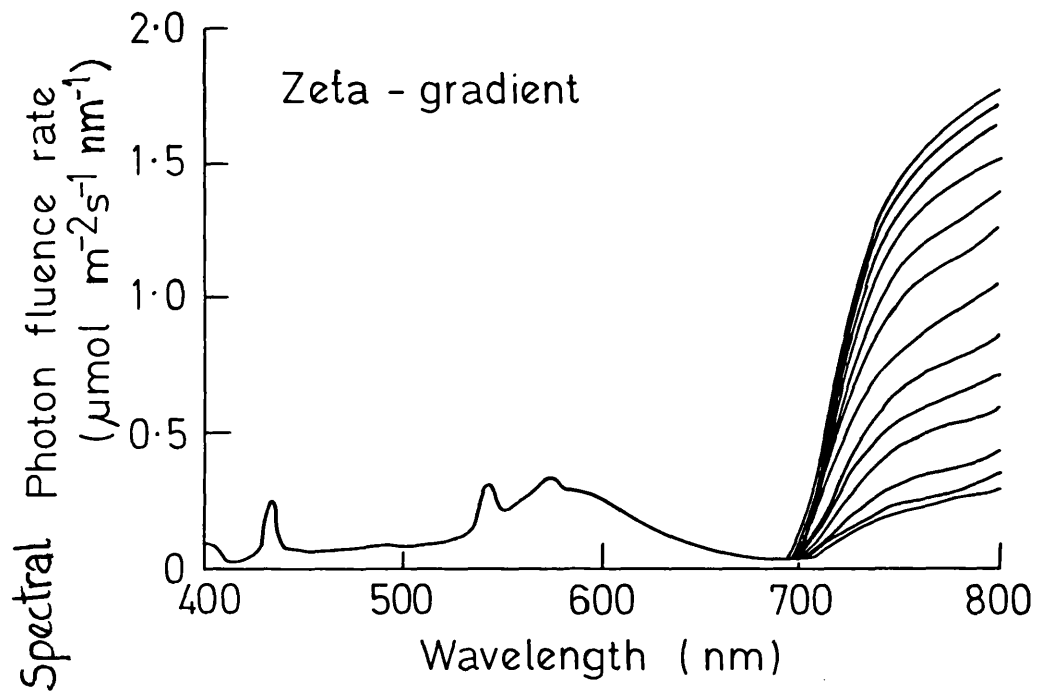
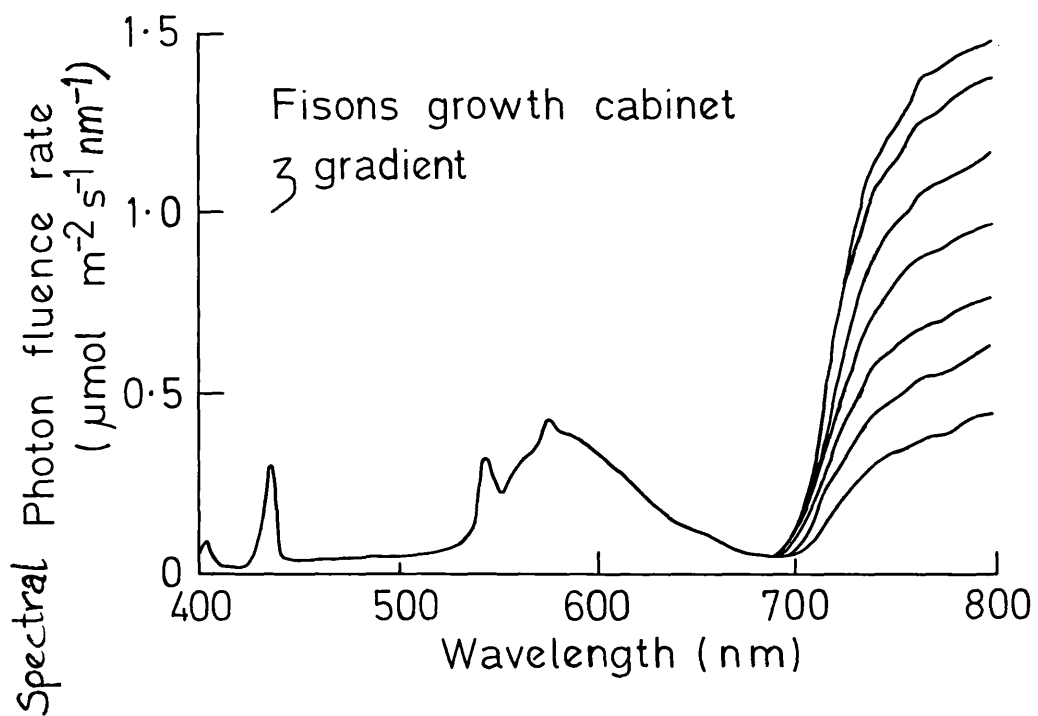

fig. a : 7



### iii Mixes of Broad Waveband light

A hood which accepts 600 mm fluorescent tubes was placed on top of a 2 m high rack in which five shelves were positioned such that they would not shade each other. This arrangement allowed a range of photon fluence rates covering about 1.5 orders of magnitude to be obtained. In preliminary experiments visible (400 - 700 nm) wavebands were achieved by wrapping ordinary warm white fluorescent tubes (20W) with one layer of coloured cinemoid while the far-red source was provided by special far-red emitting fluorescent tubes (GTE Sylvania, U.S.A.). The rack was housed in a controlled temperature growth room. In subsequent, more rigorous, experiments, the blue wave band was obtained by using "daylight" fluorescent tubes wrapped in 2 layers of blue cinemoid. Also a heat filter comprising a 1 cm depth of weak copper sulphate solution was sited beneath the fluorescent tubes such that the far-red and blue light treatments were adjusted to provide the same photoequilibrium. For spectra see figs. a : 8a and a : 8b.

### c) Light sources for construction of Action Spectrum (fig. c)

A bank of four Rank Strand 500W theatre lamps were situated on the outside wall of the dark laboratory and light was shone through collimating holes in the wall down onto the treatments via a mirror placed at  $45^{\circ}$  to the incident light. Irradiation was confined to the experimental area by the use of "black-out" curtains. Radiation heating effects were reduced by passing each beam through a  $\frac{3}{4}$  inch ( $\approx 1.9$  cm) window of flowing water and a  $2\frac{1}{4}$  inches ( $\approx 5.7$  cm) diameter circle of heat absorbing glass (Rank Aldis Ltd.) Precise temperature control was achieved by seating the petri dishes, in which the seeds were placed, on aluminium plates which were temperature controlled by water circulating from a cooling water-bath.

Monochromatic light was achieved with Interference filters (Balzers High Vacuum Ltd.) with half band widths of 5 - 10 nm.

fig. a : 8

Light sources used for distinguishing between phytochrome mediated photoinhibition and blue light receptor mediated photoinhibition of germination

a - Broad band red + far-red light source

b - Broad band blue light source

fig. a:8a

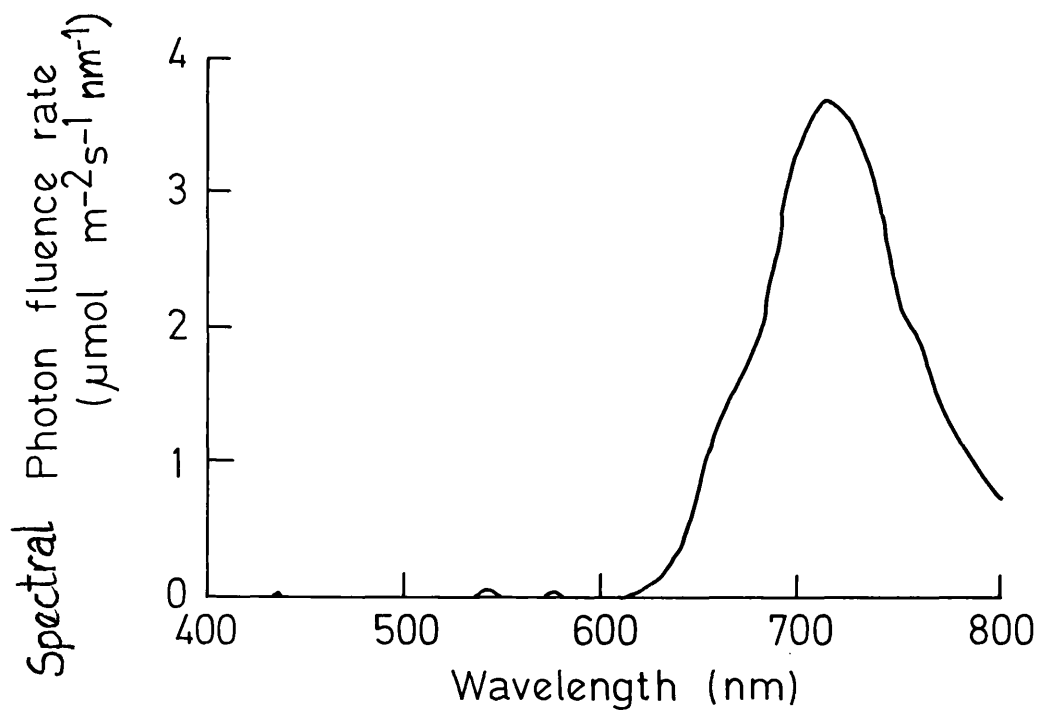

fig. a:8b

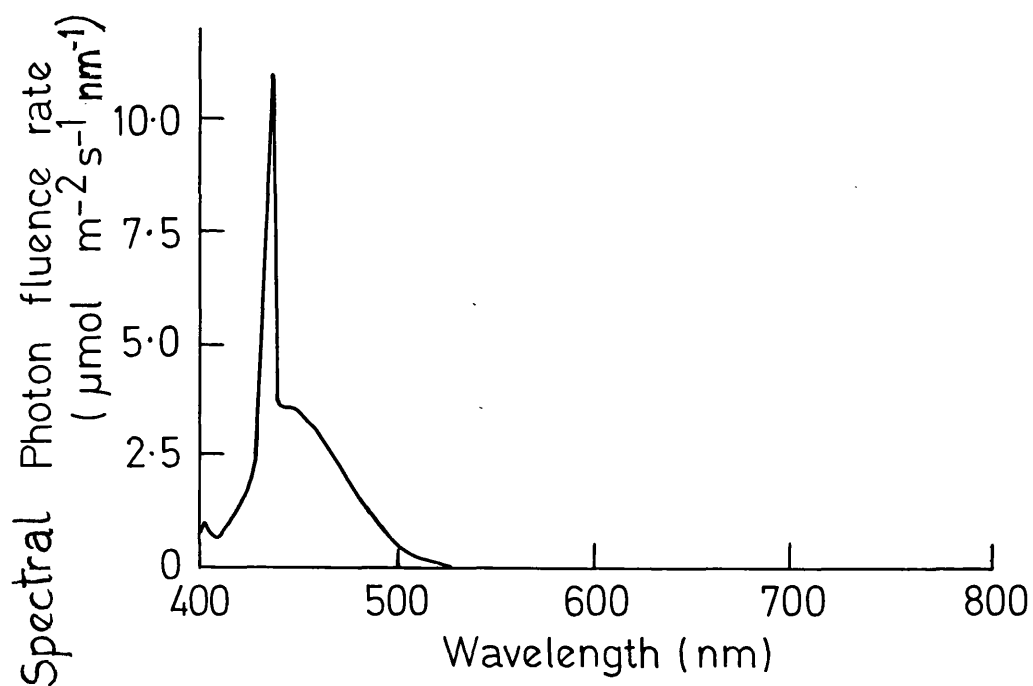

fig. c

Apparatus used for action spectrum experiments (4 off)

fig. e

Apparatus for measuring seed testa light transmission

fig. c

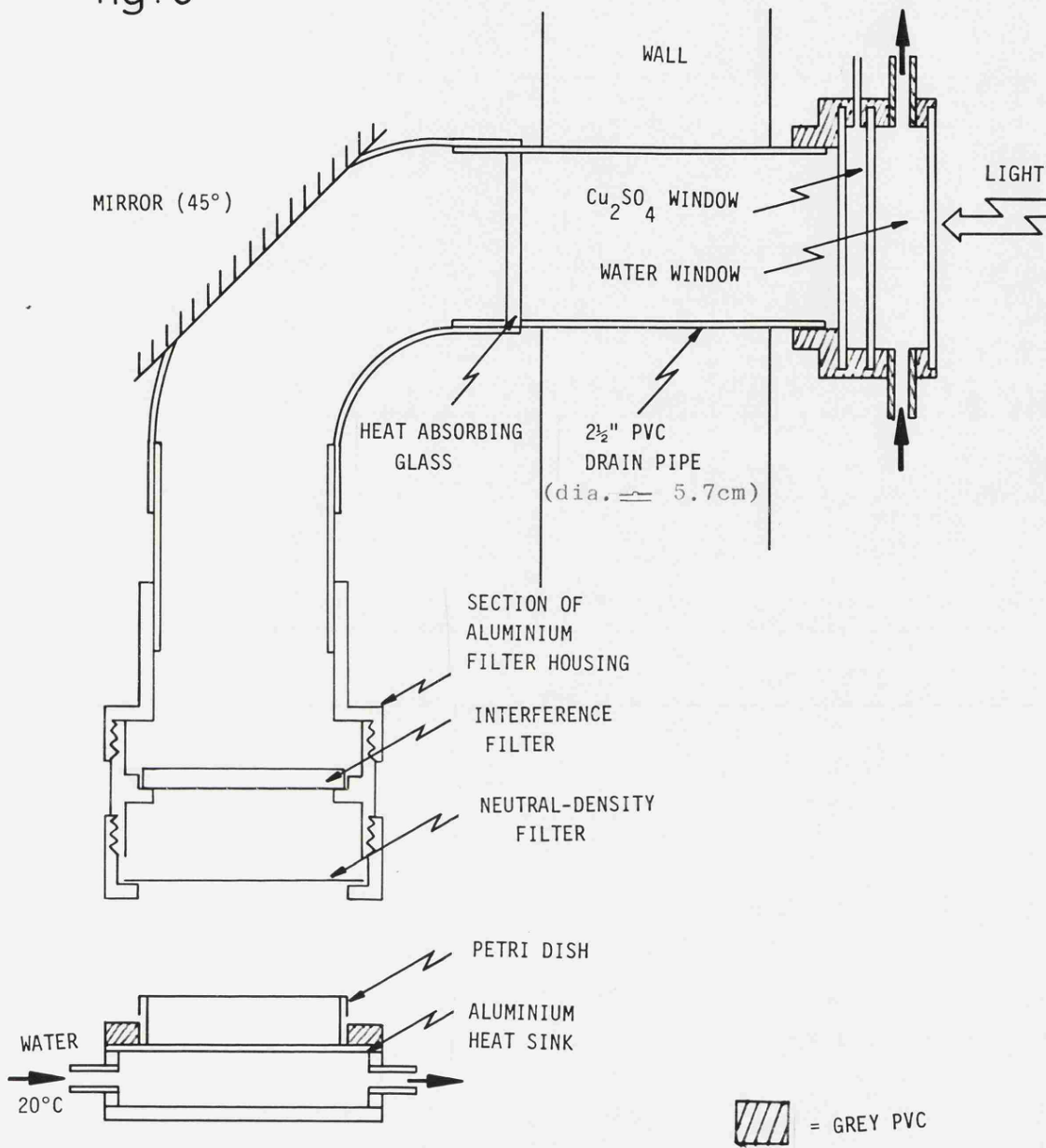
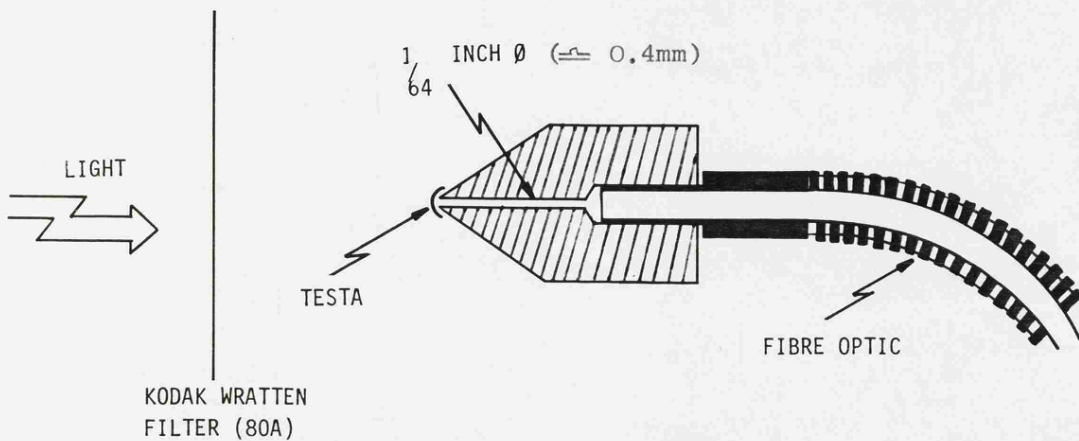

fig. e



Different photon fluence rates were achieved using Neutral Density filters (Kodak "Wratten" gelatin filters) of N.D. 1, 2 and 3, i.e. 10, 1 and 0.1% transmission respectively. Accurate transmission percentages were calculated for each filter for all the wavelengths used. Transmission of wavelengths above 700 nm was much higher than lower wavelengths and increased proportionately with lower transmission % filters.

d) Measurement of light sources

A sensitive spectroradiometer (Gamma Scientific, U.S.A.) was used to make measurements of the spectral photon distribution (s.p.d.) of each light source. The spectroradiometer comprised of a remote cosine corrected receptor head connected to the monochromator (NM - 3H) via a glass fibre optic, a photomultiplier (D - 46), scanning control (SC - 1) and digital radiometer (DR - 2). Uncalibrated scans were recorded on an XY recorder (Bryans, model 25000 A4).

The spectral information from the scan was digitised and fed into a computer program (written by Dr. P. Hayward) which corrected the uncalibrated s.p.d. curves from a data file containing the calibration value obtained from a Gamma Scientific Standard Lamp. Calibration files were upgraded regularly. The calibrated s.p.d. was then used to calculate photoequilibrium via the equation :

$$\phi_c = \frac{1}{1 + \frac{\sum_{n=\lambda_1}^{\lambda_2} (I_n \cdot a_{Pr_n})}{\sum_{n=\lambda_1}^{\lambda_2} (I_n \cdot a_{Pr_n})} \cdot \frac{1}{\text{QER}}}$$

where : I = photon fluence rate      a = absorbance at a given wavelength

QER = quantum efficiency ratio

The products of photon fluence rate and absorbance is summed across the spectrum at 1 nm intervals. By calculating  $a_{Pr}$

It is necessary here to point out a possible source of confusion concerning the use of the symbol H to denote the parameters of light which affect the cycling rate of phytochrome. H used in my experiments is not the same as H calculated in Bartley and Frankland (1982) but is in fact the same as  $\mathcal{J}$  found in Schäfer et al (1983). Nevertheless H as calculated for this thesis and H calculated by Bartley and Frankland (1982) serve the same general purpose here as an estimate of phytochrome pigment phototransformation.

and  $a_{Pfr}$  the problem of the incomplete photoconversion of Pr to Pfr is removed. The value of  $a_{Pr}$  is the same as the absorption of phytochrome that has been saturated with far-red light (FR) but  $a_{Pfr}$  is not equal to the absorption of phytochrome that has been saturated with red light (R), so :

$$a_{Pr} = a_{FR}$$

$$\text{but } a_{Pfr} = \frac{a_R - ((1 - \phi_{max}) \cdot a_{FR})}{\phi_{max}}$$

Phytochrome photoconversion rate (H) is calculated from the 2 rate constants,  $k_1$  and  $k_2$ , for the photoconversions of Pr to Pfr and Pfr to Pr respectively by the equation :

$$H = k_1 + k_2$$

$$\text{where } k_1 = \int_{\lambda_1}^{\lambda_2} \left( \frac{I_n \cdot a_{Pr_n} \cdot E_{Pr660}}{a_{Pr660}} \right) \cdot \bar{\Phi}_{Pr}$$

$$k_2 = \int_{\lambda_1}^{\lambda_2} \left( \frac{I_n \cdot a_{Pfr_n} \cdot E_{Pfr730}}{a_{Pfr730}} \right) \cdot \bar{\Phi}_{Pfr}$$

where E = extinction coefficient

$\bar{\Phi}$  = quantum efficiency

The program was modified periodically to take account of advances in the knowledge of phytochrome properties. However for the sake of consistency the  $\phi_c$  values used throughout this work are based on  $\phi_{max} = 0.75$  and QER = 1.23.

#### e) Measurement of light transmission through seed testas

The measurement of light transmission through seed testas was achieved by placing a half testa over a  $\frac{1}{64}$ " ( $\approx 0.4\text{mm}$ ) hole drilled through a cone of grey PVC. The small hole was enlarged at the flat end of the cone such that it could be placed over the fibre optic of the Gamma Scientific spectroradiometer described above. The light source consisted

Generally between 4 and 6 replicates of each treatment were made though some statistical analysis was performed on as few as 3 replicates, i.e., the experiment shown in fig. 2 : 3. Experiments described as preliminary may also have had fewer replicates.

of a 150W clear tungsten bulb filtered through a blue gelatin filter (Kodak "Wratten" 80A) in order to improve the accuracy of the measurement in the blue part of the spectrum (fig. e).

Ten typical testas were used for each species tested. The s.p.d. and photon fluence rate of the light transmitted through the testa was compared to measurements with no testa present so that % transmission for each wavelength over the 400 - 800 nm range could be calculated.

The average percentage light transmission curve obtained for each species could then be used to estimate more closely the light conditions reaching the embryo by multiplying the % transmission curve by the s.p.d. curve of the incident light source and hence an estimate of the photoequilibrium established within the seed.

## 2. Experimental Procedures

### a) Effects of light quality and quantity on seed germination

#### i Light quality and quantity - General

Except when the  $\zeta$  gradient was used seeds were imbibed on two layers of filter paper (Whatman No. 181) with about 8 ml  $H_2O$  added so that the surface just glistened. Water was added daily as required. Unless otherwise stated 50 seeds per 9 cm glass petridish were used and the temperature was maintained at  $20^{\circ}C$ .

Germination (radicle emergence) was monitored daily, and germinated seeds removed, until there had been 3 days without further germination or only 1 seed had germinated in 4 days. Except for the experiments with Amaranthus caudatus, when final germination percentages were counted, a value named the Germination Index ( $\bar{g}$ ) was calculated (Frankland, 1976) :

$$\bar{g} = \frac{1}{t'} \cdot \frac{P}{100}$$

where  $t'$  = time in days to  $\frac{1}{2}$  final germination

P = final germination percentage

The advantage of using  $\bar{g}$  is that it takes into account both the rate and extent of germination.

When using the  $\bar{z}$  gradient blotting paper was used to imbibe the seeds on because the air circulation arrangement caused a higher evaporation potential and filter papers dried too rapidly. The usable light gradient was of sufficient size to mark out 13 x 2.5 cm sections in each of which were placed 50 seeds (unless otherwise stated).

ii Light quality - Specific

Unless otherwise stated continuous light was used in all experiments. Dark control treatments were monitored daily by counting germination under dim green "safe light". Dark treatment seeds were kept in an incubator set at 20°C and situated in the dark laboratory.

iii Light quantity - Specific

Urtica urens was given photoperiods varying in length from 30s to continuous light and also intermittent irradiations. The short photoperiods and intermittent irradiations were controlled by placing the petri dishes in 4 inch ( $\approx$ 10 cm) diameter, light tight tins (Delapack Ltd.) and opening and closing these as required. Under these circumstances the germination was monitored when the tins were conveniently open but as near as possible to the same time each day. When photoperiods were only 1.5 minutes or less germination was counted under dim green "safe light". Each petri dish contained 100 seeds.

Chenopodium album: different photoperiodic and intermittent irradiation treatments were given to seeds placed on the  $\bar{z}$  gradient. Timing of light regimes was controlled by a timer-switch. Germination was counted during light periods.

Amaranthus caudatus seeds were given a light regime of 8h darkness followed by 24h of light treatment prior to the counting of germination. In the action spectrum experiments the seeds were imbibed in 50 mm diameter plastic petri dishes on circles of blotting paper cut to fit.

b) Effects of light on secondary dormancy induction

The induction of secondary dormancy was achieved by placing imbibed seeds under light sources which inhibited germination. The seeds were left for varying lengths of time prior to transferring them to promotory conditions i.e. fluorescent WL for C. album and Rumex obtusifolius, and darkness for Amaranthus caudatus. Inhibitory light sources consisted of fluorescent WL with various amounts of supplementary far-red light either to provide different photoequilibria at constant PAR or to provide constant  $\phi_c$  at different photon fluence rates.

The few seeds that germinated prior to transfer were disregarded and the degree of secondary dormancy was measured by calculating the germination index ( $\bar{g}$ ) of those seeds which remained. Seeds were monitored daily until no germination had occurred in 3 days or only one seed had germinated in 4 days.

In the case of A. caudatus seeds complete secondary dormancy induction had occurred after 3 days under an inhibitory light source giving  $\phi_c = 0.342$ . So for A. caudatus seeds the procedure was to give a 2 day light treatment, then transfer the seeds to darkness to allow maximum germination.

c) Imbibition experiments

Seeds of A. caudatus were imbibed on two layers of filter paper (Whatman No. 181) either in darkness or under an inhibitory light source. After the prescribed time from sowing the seeds were picked off as quickly as possible and damped off with tissue paper. Fresh weights were then measured and the seeds placed in a dessicator for about 2 weeks until dry. The seeds were then reweighed so that percentage water content could be calculated for different times of imbibition.

d) Respiration measurements

Respiration rates of A. caudatus seeds were measured using Warburg respirometers. 140 mg of seeds ( $\approx 200$ ) were imbibed on a hollow dish

of filter paper (Whatman No. 181) which is cut to fit in the bottom of a Warburg flask. The filter paper was wetted with 0.6 mls. of distilled water.

Respiration was measured as oxygen uptake so carbon dioxide evolved by the seeds was absorbed by 0.5 mls. of 50 mM KOH placed in the centre well of the flask along with a filter paper wick. The centre well rim was greased to prevent the KOH from "creeping over" and affecting the seeds.

The total volume of the experimental materials placed in each flask was approximately 0.2 mls and the flask constants (k) for each flask was calculated using this equation :

$$kO_2 = \frac{Vg \cdot \frac{273}{T} + (V_f \cdot \alpha)}{Po}$$

where  $kO_2$  = flask constant for oxygen

$Vg$  = gas volume : total volume - fluid volume

$T$  = temperature in Kelvin

$V_f$  = fluid volume (0.2 mls)

$\alpha$  = oxygen solubility (mls. gas dissolved per ml. fluid)

- at 20°C,  $\alpha = 0.031$

$Po$  = standard pressure (10,000 mm for Brodie's solution)

The volume of oxygen uptake is calculated from the flask constant multiplied by the difference in pressure in mm (h) as read off the manometers :

$$\mu\text{l gas} = kO_2 \cdot h$$

From this the rate of oxygen uptake can be calculated in terms of dry weight of seeds :

$$Q_{O_2} = \mu\text{l gas mg}^{-1} \text{ h}^{-1}$$

A control flask containing everything but the seeds was used so that atmospheric pressure changes could be accounted for. Manometer readings were taken each hour and experiments done in darkness had their readings

taken by dim green "safelight". Six treatment flasks were used for each experimental run.

### 3. Seed Sources

<u>Species</u>	<u>Source</u>
Amaranthus caudatus	Asmer Seeds, Leicester (Batch L2548)
Cecropia obtusifolius	Mexico - <sup>0</sup> / <sub>2</sub> coloniser of rain forest
Chenopodium album	Arable Field, East of Leicester
Digitalis purpurea	Emorsgate Seeds, Kings Lynn
Geranium robertianum	Swithland Wood, Leics.
Geum urbanum	Monsal Dale, Derbys.
Lactuca sativa (cv. Great Lakes)	Asmer Seeds
Myosotis sylvatica	Emorsgate Seeds
Plantago major	" "
Papaver rhoeas	" "
Rumex obtusifolius	" "
Silene dioica	" "
Silene vulgaris	" "
Sinapis arvensis	" "
Stachys sylvatica	" "
Taraxacum officinale	Streets in Leicester
Teucrium scorodonia	Swithland Wood, Leics.

Before experimentation seeds were cleaned of any investing structures and selected for uniformity of appearance. Surface sterilizing was usually unnecessary and the few seeds that became infected during an experiment were removed from the petri dish.

## RESULTS & DISCUSSION

### Germination Responses to Various Light Regimes

#### 1. Light Quality

An experiment was performed to investigate whether seeds of Chenopodium album responded to light quality under natural conditions. Seeds were sown on filter papers which were kept moist via a remote watering system and placed at a height of 10 cm above soil level in three treatments. The treatments were 1) in a Sugar Beet stand (a crop in which C. album is often found in large numbers); 2) in the open, and 3) under shade netting, the density of which was adjusted to give the same photon fluence rates of photosynthetically active radiation (PAR) as light beneath the Sugar Beet stand as it developed. 200 seeds were used for each treatment and the experiment was performed starting on two dates : 1) 7th July 1981 and 2) 11th August 1981. Light conditions within the canopy during the experiments can be seen in table 1 : 1.

The results (figs. 1 : 1a, 1 : 1b) show that there is little difference between the shade netting and open treatments indicating that photon fluence rate plays little part in influencing the germination of C. album. The slower rate of germination in the second experiment of seeds under artificial shade may be due to the fact that by August the density of the Sugar Beet stand had become so great that shade netting had to be replaced by sheets of black plastic with holes bored through and the resulting increase in temperature within this treatment may have caused thermal inhibition of germination.

At both stages of Sugar Beet canopy development C. album seeds within the stand showed much reduced germinability being lowest in the second experiment when the canopy was denser. This indicates that for C. album seeds germination is primarily dependent on light quality,

Table 1 : 1

Characteristics of light conditions beneath Sugar Beet canopy  
during experiment of fig. 1 : 1

Table 1 : 1

		$\beta$	$\phi_c$	400-700 $\mu\text{mols m}^{-2} \text{s}^{-1}$	400-800 $\mu\text{mols m}^{-2} \text{s}^{-1}$	cloud cover
7th July 1981	Sunrise	0.94	0.49	4.53	6.70	5/8
	Mid-day	1.17	0.54	1259.33	1680.45	6/8
	Sunset	1.28	0.53	37.45	48.82	0/8
28th July	Sunrise	0.50	0.44	2.10	3.64	5/8
	Mid-day	0.85	0.51	369.74	541.33	7/8
	Sunset	0.48	0.41	3.72	7.98	8/8
18th August	Sunrise	0.26	0.34	0.37	0.93	
	Mid-day	0.30	0.38	37.90	85.22	
	Sunset	0.16	0.31	0.09	0.25	
29th September	Sunrise	0.03	0.09	0.07	1.00	
	Mid-day	0.04	0.13	4.40	38.40	
	Sunset	0.02	0.10	0.02	0.14	

fig. 1 : 1

Germination of Chenopodium album seeds sown in a stand of

Sugar Beet :

- — ○ in open daylight
- — ● beneath shade netting
- △ — △ beneath Sugar Beet canopy

a - sown on 7th July 1985

b - sown on 11th August 1985

fig. 1:1a

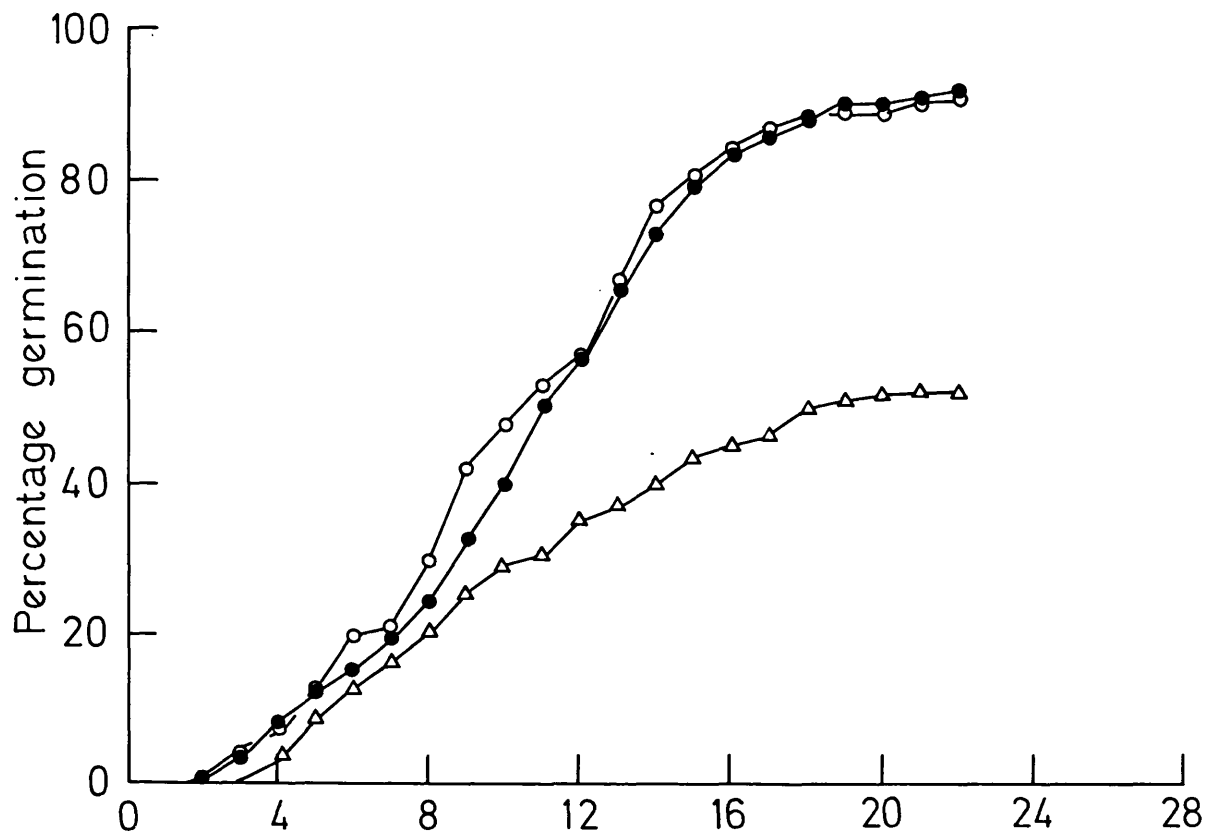
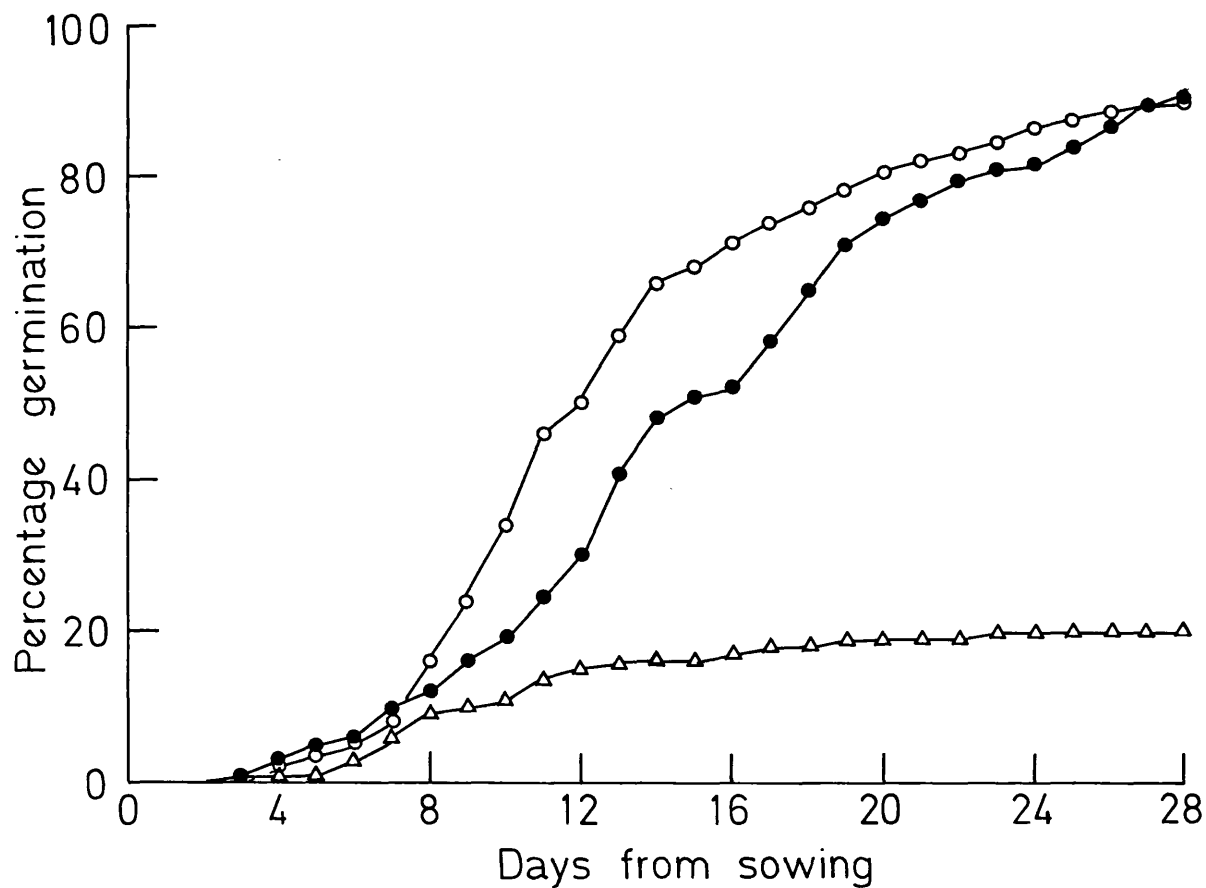

fig. 1:1b



at least for seeds on the soil surface with an adequate water supply.

The seeds of a number of species which are normally considered as either "shade" or "open" habitat species were tested for germination in the light quality cabinets in order to investigate whether their habitat is related to the response of the seeds to light quality. The results can be seen in table 1 : 2. There does not appear to be any consistent difference in the pattern of germination response to  $\zeta$  between "shade" or "open" habitat species although there is possibly a slight tendency for "shade" species to show a lower rate of decline in germination as  $\zeta$  becomes lower. The lack of difference is not altogether surprising since "shade" species tend to germinate and establish seedlings well before canopy closure has occurred and so there is only weak selection pressure, if any, for developing insensitivity to  $\zeta$  changes.

During the course of these experiments technical difficulties occurred with light bulbs blowing, especially in  $\zeta$  cabinet 2. Here the  $\phi_c = 0.51$  was established by the use of 4 x 150W tungsten bulbs as a far-red source. It appeared that if 1 or 2 bulbs failed the germination would rise sharply. Hence the results in the table under  $\zeta$  2 are somewhat suspect. It was, however, interesting that a small change in  $\phi_c$  above 0.51 should have such a dramatic effect on the germination pattern of many species, so a more detailed study was required. A gradient of  $\zeta$  was set up such that a range of  $\phi_c$  between 0.372 and 0.594 was established. The gradient was separated into 13 sections and 50 seeds were sown in each (except for 100 seeds per section for Digitalis purpurea). The results (fig. 1 : 2) show that for 4 out of 5 of the species used there was a sharp decline in germinability in the range of  $\phi_c$  from 0.6 down to 0.55. In the fifth case (Digitalis purpurea) the germinability declines only slightly over the whole range.

It is an attractive idea to think that the sharp decline in

**Table 1 : 2**

**Germination of a range of open and shade habit species under lights establishing different photoequilibria and in darkness.**

**Left hand numbers in each column indicate the following :**

- 1 - 1 rep. of 50 seeds**
- 1a - 1 rep. of 100 seeds**
- 1b - 1 rep. of 125 seeds**
- 2 - 2 reps. of 50 seeds**
- 3 - 3 reps. of 125 seeds**

Table 1 : 2

Species	Habitat	% Germination				
		$\bar{z}^1,$ $\phi_c = 0.69$	$\bar{z}^2,$ $\phi_c = 0.51$	$\bar{z}^3,$ $\phi_c = 0.41$	$\bar{z}^4,$ $\phi_c = 0.35$	Dark
<i>Amaranthus caudatus</i>		1 0	1 0	1 0	1 0	1 96
<i>Cecropia obtusifolius</i>	Open	1b 82	1b 82	1b 0	1b 0	1b 0
<i>Chenopodium album</i>	Open	3 88	3 19	3 14	3 10	3 13
<i>Lactuca sativa</i>	Open	1 98	1 96	1 0	1 0	1 98
<i>Papaver rhoeas</i>	Open	1a 0	1a 3	1a 0	1a 1	1a 0
<i>Plantago major</i>	Open	1 58	1 58	1 42	1 28	1 0
<i>Rumex obtusifolius</i>	Open	2 100	2 94	2 0	2 0	2 0
<i>Taraxacum officianale</i>	Open	2 70	2 84	2 12	2 23	2 51
<i>Urtica urens</i>	Open	1a 5	1a 0	1a 0	1a 0	1a 13
<i>Digitalis purpurea</i>	Shade/ Open	1a 91	1a 88	1a 79	1a 70	1a 5
<i>Geranium robertianum</i>	Shade	1 46	1 34	1 44	1 6	1 24
<i>Geum urbanum</i>	Shade	1 66	1 14	1 0	1 0	-
<i>Myosotis sylvatica</i>	Shade	2 69	1 64	1 38	2 22	2 37
<i>Silene dioica</i>	Shade	2 71	1 48	2 0	2 1	2 13
<i>Silene vulgaris</i>	Shade	1 58	1 26	1 0	1 0	1 18
<i>Stachys sylvatica</i>	Shade	2 6	2 10	2 0	2 2	2 0
<i>Teucrium scorodonia</i>	Shade	1 52	1 40	1 34	1 38	1 0

fig. 1 : 2

Germination of five species in response to photoequilibrium established by the "zeta gradient". The vertical line represents the daylight value of photoequilibrium

- Taraxacum officianais
- Chenopodium album
- ▲—▲ Digitalis purpurea
- Rumex obtusifolius
- △—△ Geum urbanum

fig. 1:2

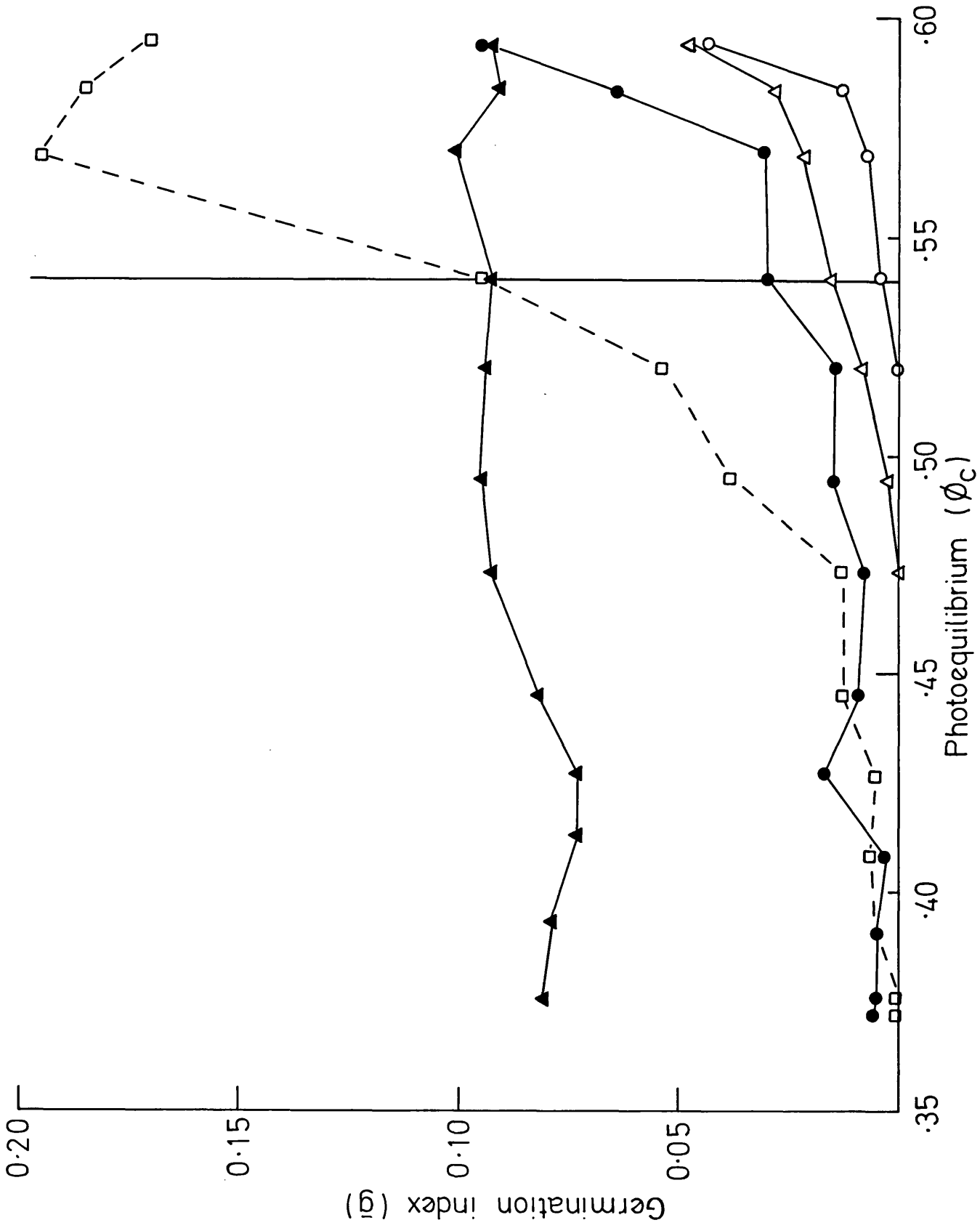

germinability which occurs is the result of an in-built mechanism which allows a seed to detect whether it is being shaded by a vegetative canopy or not since the value of  $\phi_c$  for open daylight is approximately 0.55 and is reduced below this figure under vegetative shade. D. purpurea is a species which grows in all types of environment with respect to light (i.e. from open places to woodland) but there is no obvious ecological reason why it should show less inhibitory response of germination to low  $\phi_c$ .

Despite the attractiveness of the proposition that some seeds can detect and show markedly reduced germination to the smallest amount of vegetative shade it is, however, possible that the effect is to some extent artifactual. Although PAR is constant along the gradient the construction of the light source determines that the total photon fluence rate in the 400 - 800 nm wavelength range increases towards the "low"  $\phi_c$  end as, consequently, does phytochrome cycling rate (H). The "low"  $\phi_c$  used in the gradient is quite sufficient to inhibit the germination of most light sensitive seeds under conditions of prolonged irradiation yet for short irradiation experiments the same "low"  $\phi_c$  may be sufficiently high to fulfill the requirements for maximum germination. In other words the combination of relatively high fluence rates of prolonged irradiation and the low  $\phi_c$  both contribute to the photoinhibition of germination; i.e., the HIR of phytochrome action is probably involved. This will be examined more closely in the section on "Germination Responses to Light Quantity". Nevertheless seeds of species which do exhibit a sharp transition of germinability tend to show this at  $\phi$  values similar to those for open-daylight. We should not disregard the possibility that this may confer some survival advantage for seeds that respond in such a way.

Apart from vegetative canopies, another layer that will alter both the quality and quantity of light reaching the seed embryo is the testa

of the seed itself. Spectral transmittance values of testas from 8 species are shown in fig. 1 : 3 a - h. In general dark-coloured seeds transmit only the longer wavelengths, often completely excluding any blue light, and lighter-coloured seeds tend towards being neutral density filters. The testas of Amaranthus caudatus, especially, are quite good neutral density filters although there is still a tendency for relatively greater transmittance at longer wavelengths.

It will be seen later that the sensitivity to photoinhibition of germination by high photon fluences is to some degree related to testa colour, being greater in seeds with comparatively light testas. This could be due to the relatively high transmission of blue light and may point towards another photoreceptor other than phytochrome being involved.

In order to postulate such an effect it is necessary to show that the light transmission of the testa does indeed have an influence on germination.

Seeds of C. album were germinated in the 3 cabinets on two occasions where the supplementary far-red was achieved by using different filtering systems; i.e., in the first case using a far-red filter made of a red and a green sheet of perspex, and in the second case by using "far-red" perspex. It can be seen from fig. 1 : 4a that the germination response of C. album is rather different in the two treatments.

If, now, the spectral photon distribution (SPD) of the transmitted light through the C. album testa is multiplied by the SPD of the incident light in each of the 3 cabinets a new value of photoequilibrium to estimate the light quality effects on the embryo ( $\phi_t$  - where t signifies testa) can be calculated.

If the germination response is now plotted against  $\phi_t$  it can be seen that the points now all lie on the same curve (fig. 1 : 4b) thus indicating the importance of the testa in altering the light quality

fig. 1 : 3

Percentage light transmission of the seed testas of eight species over the range 400- to 800 nm

- a - Cecropia obtusifolius
- b - Amaranthus caudatus
- c - Urtica urens
- d - Rumex obtusifolius
- e - Geum urbanum
- f - Lactuca sativa (cv. Great Lakes)
- g - Sinapis arvensis
- h - Chenopodium album

fig. 1:3 a-d

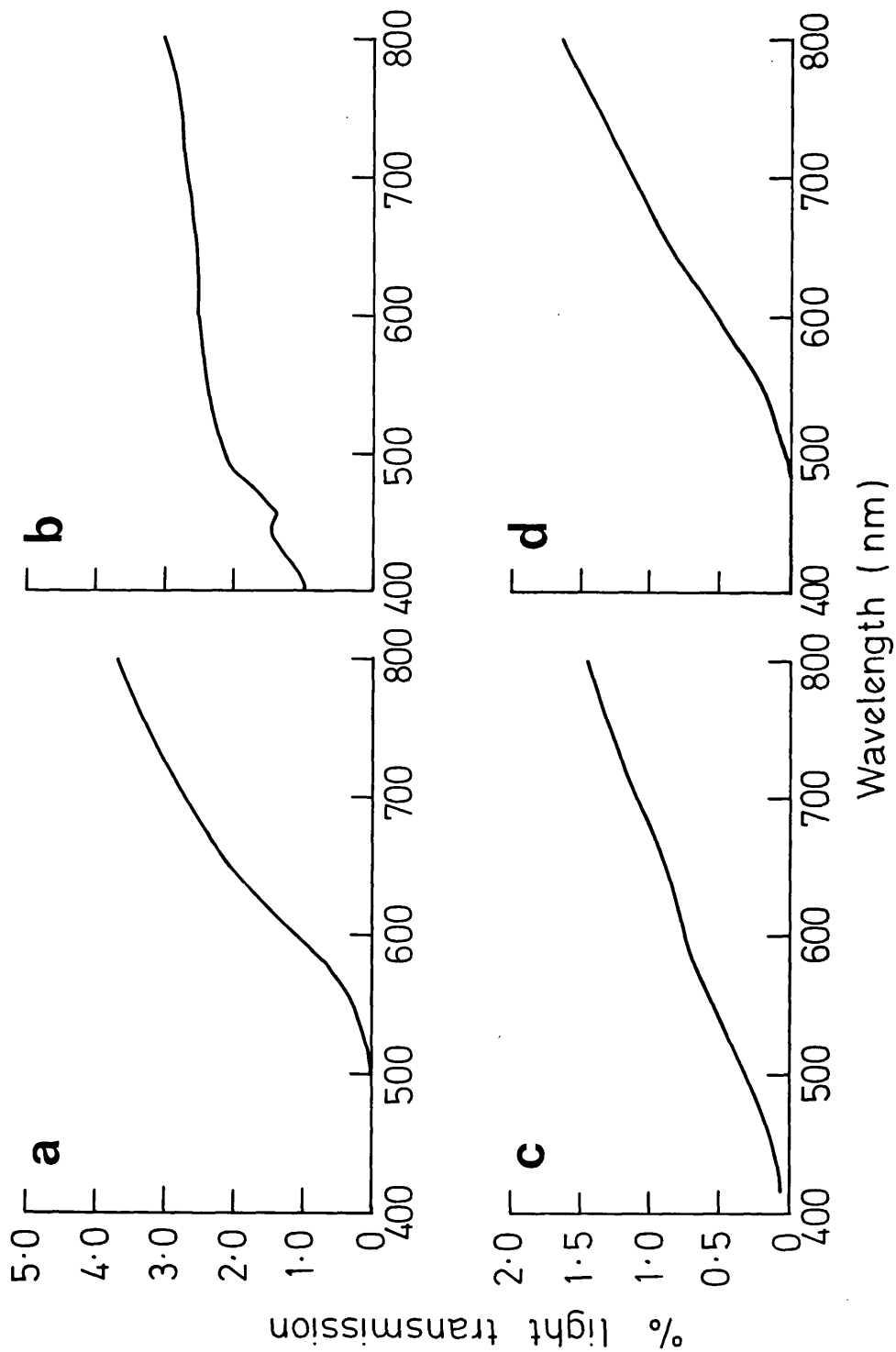

fig. 1:3 e-h

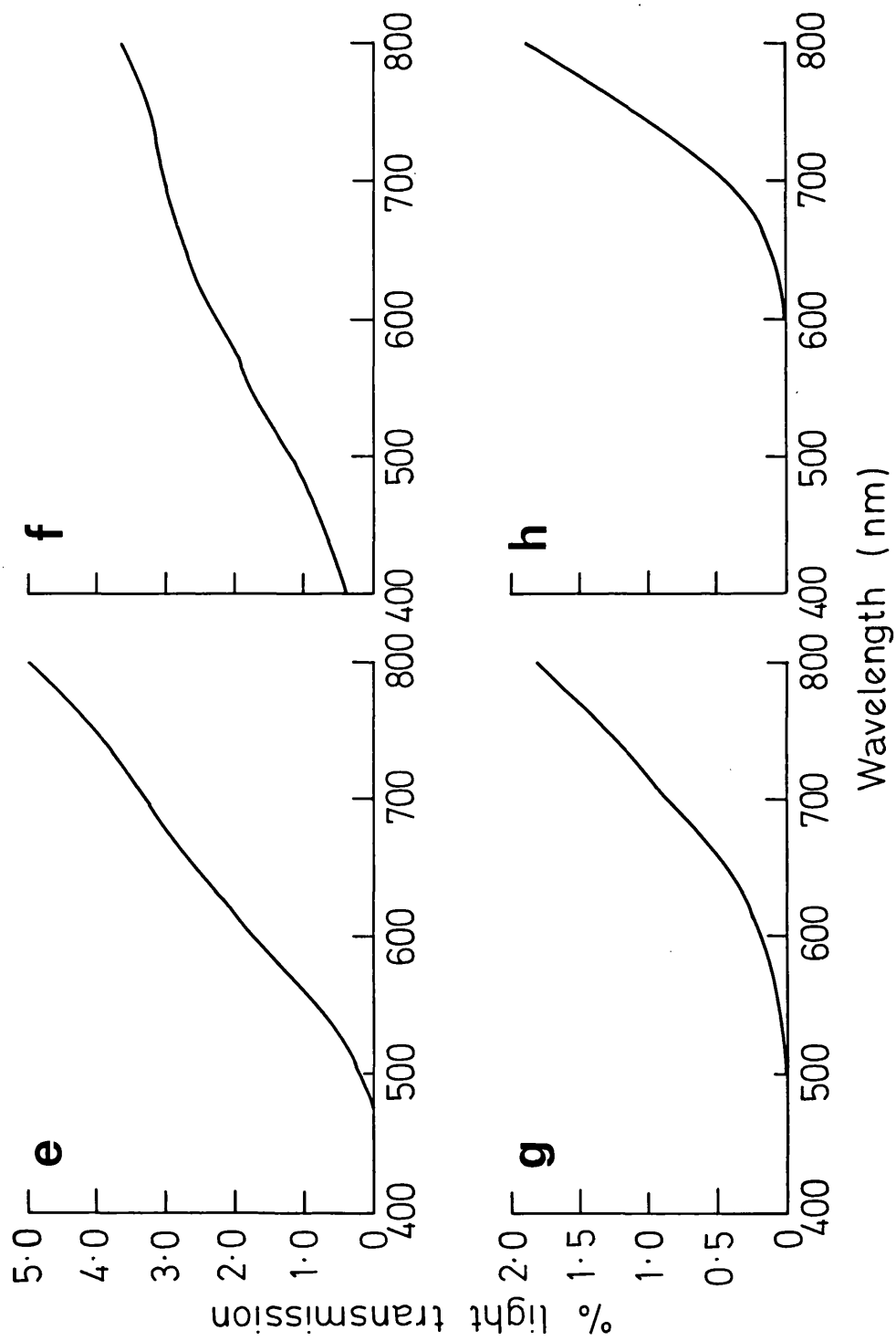

fig. 1 : 4

Germination response of C. album in the "zeta cabinet" fitted  
with two different types of far-red filter

Red and green perspex

Far-red perspex

a - germination plotted against calculated photoequilibrium ( $\phi_c$ )

b - same data as in (a) plotted against photoequilibrium

calculated from the spectral photon distribution transmitted

through the seed testa ( $\phi_t$ )

fig. 1:4 a

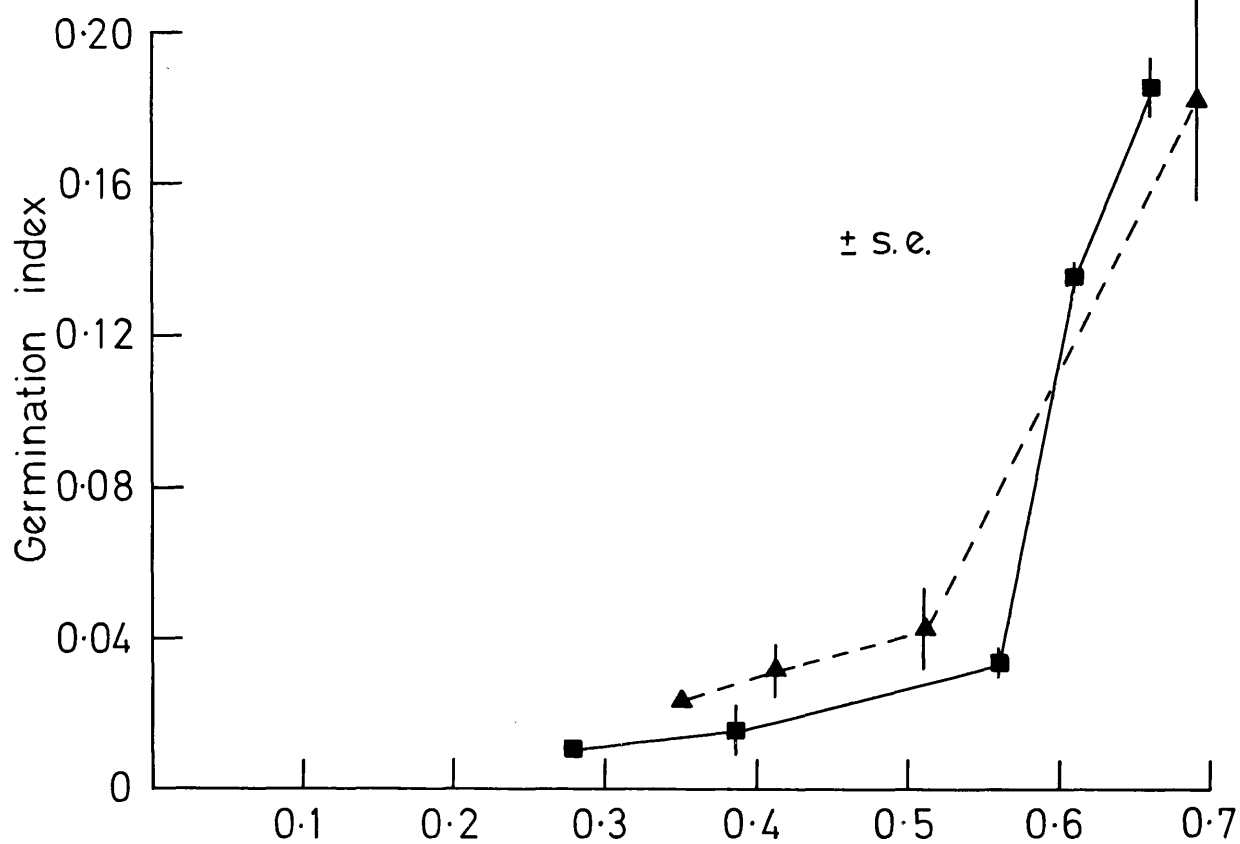
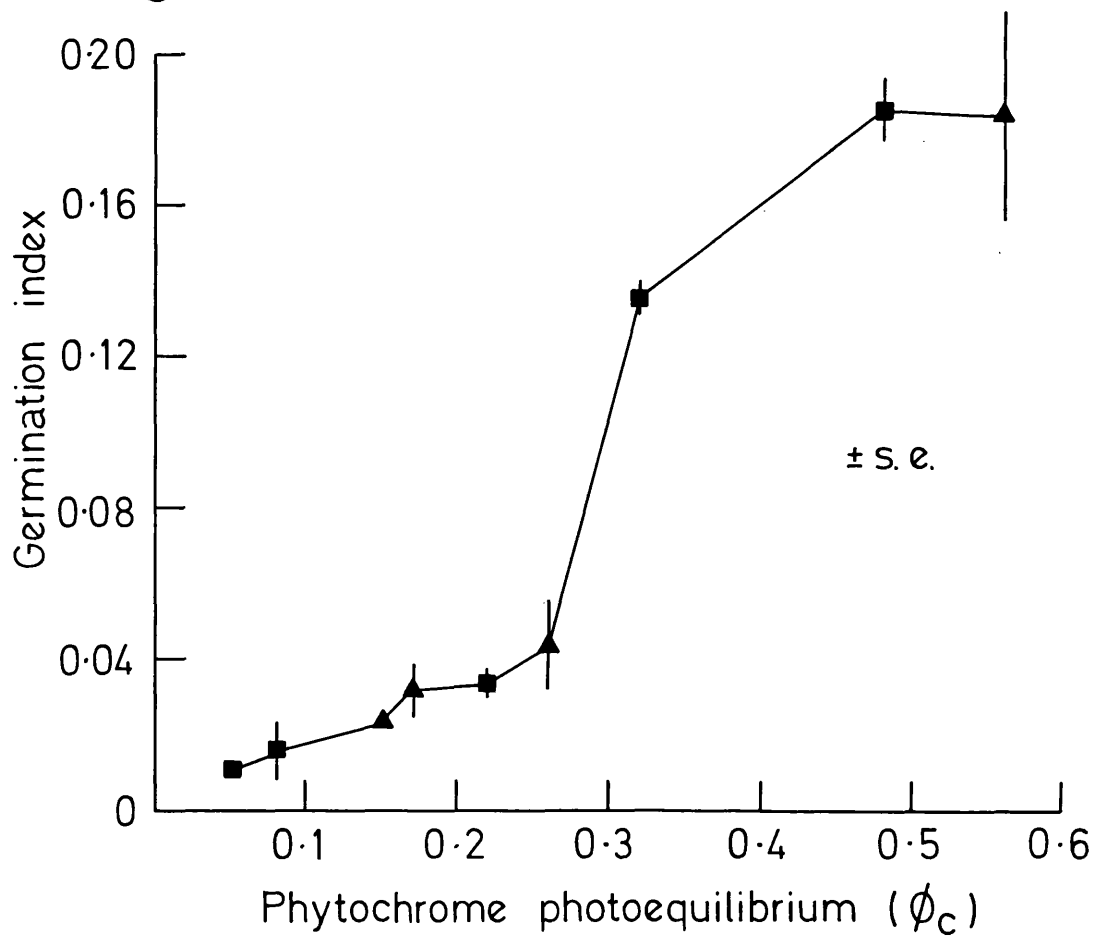

fig. 1:4 b



perceived by the embryo.

## 2. Light Quantity

Some species show photoinhibition of germination even under fluorescent white light (WL) ( $\phi_c \approx 0.65$ ) if given at sufficiently high fluence rates and/or for prolonged periods. Seeds of 4 species were irradiated at different photon fluence rates and photoperiods and the germination measured (fig. 2 : 1). Those species, A. caudatus and Urtica urens, which are sensitive to photoinhibition under fluorescent WL show decreased germination in response to higher photon fluence rates and longer photoperiods. So, total fluence is important in controlling photoinhibition and possibly there is also a time-dependent factor; i.e., the response shows the characteristics of the HIR.

These responses were studied further with Urtica urens, Chenopodium album and Amaranthus caudatus.

### a) Urtica urens

Seeds of U. urens were treated to different photoperiods and photon fluence rates of fluorescent WL (fig. 2 : 2) and germination was found to decrease with increase of both factors. However a short irradiation, even of high fluence rate, resulted in higher germination than a dark control (i.e., light is either promotory or inhibitory depending on its duration). So even on a daily basis it appears possible that both the LER and HIR of phytochrome may be operating.

A more detailed study of this effect was made with seeds irradiated at 20 or 200  $\mu\text{mols m}^{-2} \text{s}^{-1}$  for a wide range of photoperiods - i.e., from 5s to 10h.

The results (fig. 2 : 3) clearly show an initial rise in the level of germination followed by a slow decline as photoperiods increase. This pattern occurs at both photon fluence rates but the interesting point is that the peak occurs after 300s at 20  $\mu\text{mols m}^{-2} \text{s}^{-1}$  and after 30s at 200  $\mu\text{mols m}^{-2} \text{s}^{-1}$  - i.e., at equal total fluences. So, up to

fig. 2 : 1

Germination response of four species to different photoperiods and photon fluence rates of fluorescent white light

- C. album: 40, 100, 270  $\mu\text{mols m}^{-2} \text{s}^{-1}$
- Plantago major: 40, 100, 270  $\mu\text{mols m}^{-2} \text{s}^{-1}$
- ▲—▲ Amaranthus caudatus: 40  $\mu\text{mols m}^{-2} \text{s}^{-1}$
- ) ( 40  $\mu\text{mols m}^{-2} \text{s}^{-1}$   
) (
- ) Urtica urens: ( 100  $\mu\text{mols m}^{-2} \text{s}^{-1}$   
) (
- △—△) ( 270  $\mu\text{mols m}^{-2} \text{s}^{-1}$

fig. 2 : 2

Germination response of Urtica urens to different photoperiods and photon fluence rates of fluorescent white light

- 25  $\mu\text{mols m}^{-2} \text{s}^{-1}$
- 300  $\mu\text{mols m}^{-2} \text{s}^{-1}$
- Dark control

fig. 2:1

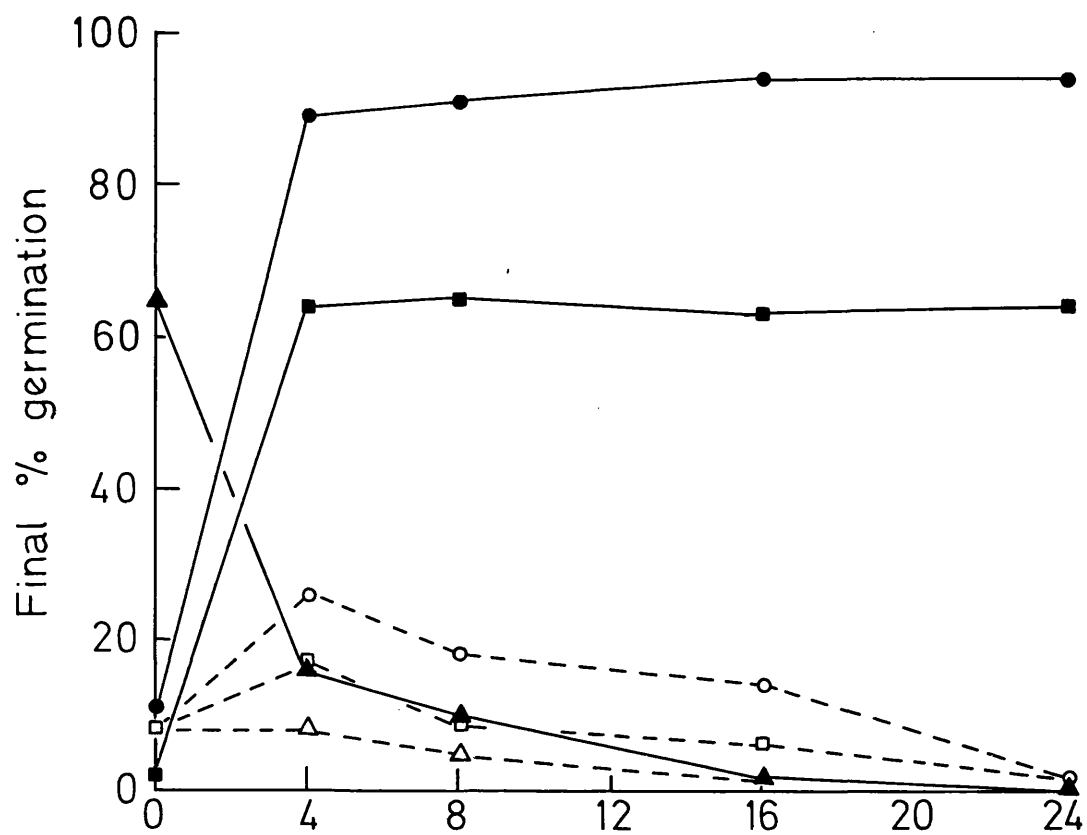

fig. 2:2

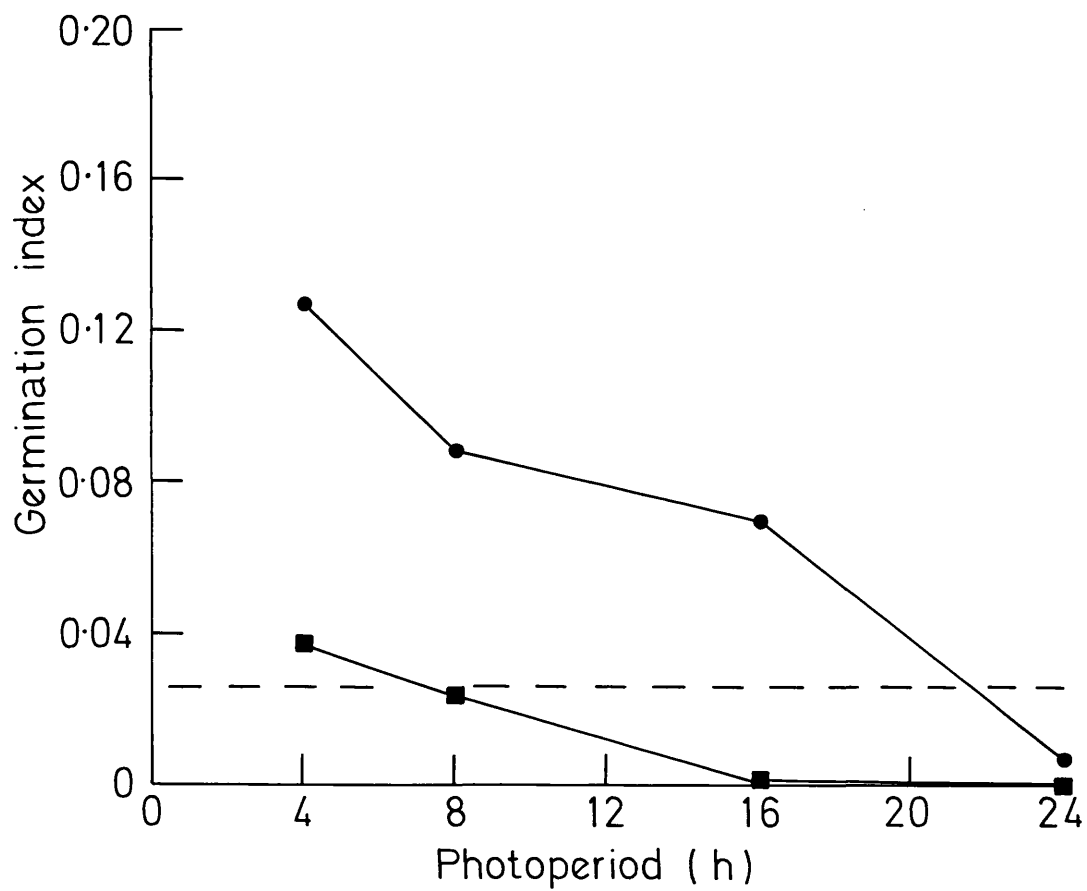
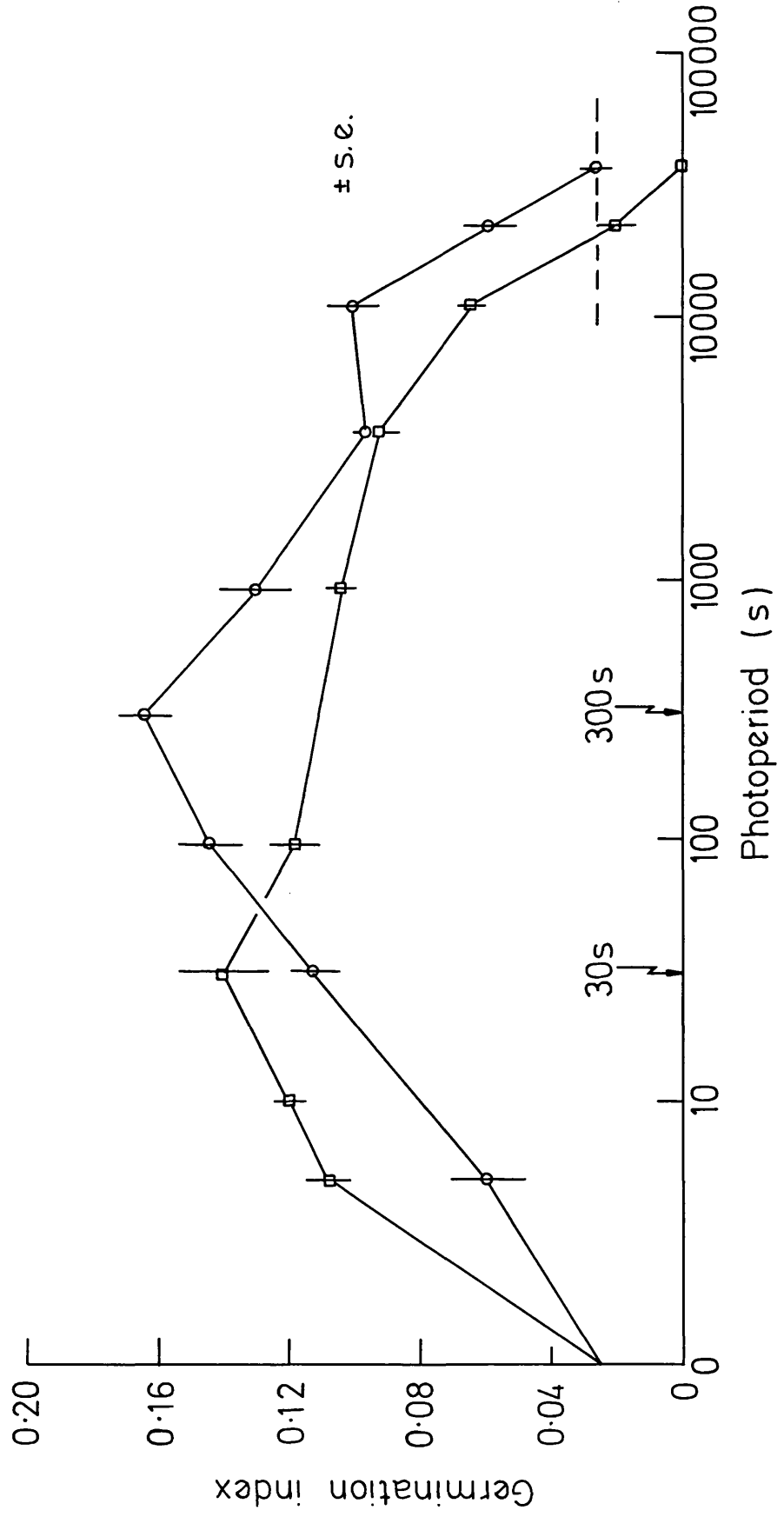

fig. 2 : 3

Germination response of U. urens to a wide range of photoperiods  
at a high and a low photon fluence rate of fluorescent white light

○—○ 20  $\mu\text{mols m}^{-2} \text{s}^{-1}$   
□—□ 200  $\mu\text{mols m}^{-2} \text{s}^{-1}$   
----- dark control

fig. 2:3



the point of the peak, germination seems to be fluence-dependent (reciprocity holds) and is therefore in agreement with the characteristics of the LER. In other words the phytochrome system within the seeds is apparently capable of acting in a promotive, LER way on a daily basis resulting in the gradual stimulation of germination. However if daily photoperiods become longer than a few minutes (at least at these relatively high photon fluence rates) then the level of germination begins to decline again. The combination of high fluence rates and long photoperiods causes inhibition of germination until at 10h for  $20 \mu\text{mols m}^{-2} \text{ s}^{-1}$  and 5.5h at  $200 \mu\text{mols m}^{-2} \text{ s}^{-1}$  germination is reduced back down to dark levels. In the declining part of the curve fluence dependence is lost and time dependence becomes important - i.e., the response is showing the characteristics of the HIR. The peaks of germination seen in fig. 2 : 3 may, then, represent the transition from LER to HIR effects.

To illustrate this further various photon fluence rates and photoperiods were arranged to provide two different daily total fluences. Germination response to daily total fluences of  $18 \text{ mmols m}^{-2}$  and  $720 \text{ mmols m}^{-2}$  are shown in figs. 2 : 4a and 2 : 4b respectively. In the first case germinability remains constant ( $18 \text{ mmols m}^{-2}$  represents the broad peak of germination promotion) despite the duration of the daily photoperiod; i.e., promotion is maintained at least while photoperiods are kept fairly short. In the second case germination decreases with increasing photoperiods. If the total fluence is given in a short period, the germination can be kept high, but when given over longer periods (several hours) the time-dependent aspects of HIR take precedence. So, it is not only the total fluence that is important, since the same amount of light, depending on its duration, can either cause promotion or marked inhibition of germination.

Further evidence about time dependency comes from experiments

fig. 2 : 4a

Germination response of U. urens to low daily photon fluence  
(18 mmols m<sup>-2</sup>) given over different daily photoperiods of relatively  
short duration

fig. 2 : 4b

Germination response of U. urens to high daily photon fluence  
(720 mmols m<sup>-2</sup>) given over different daily photoperiods of relatively  
long duration

fig. 2 : 4a

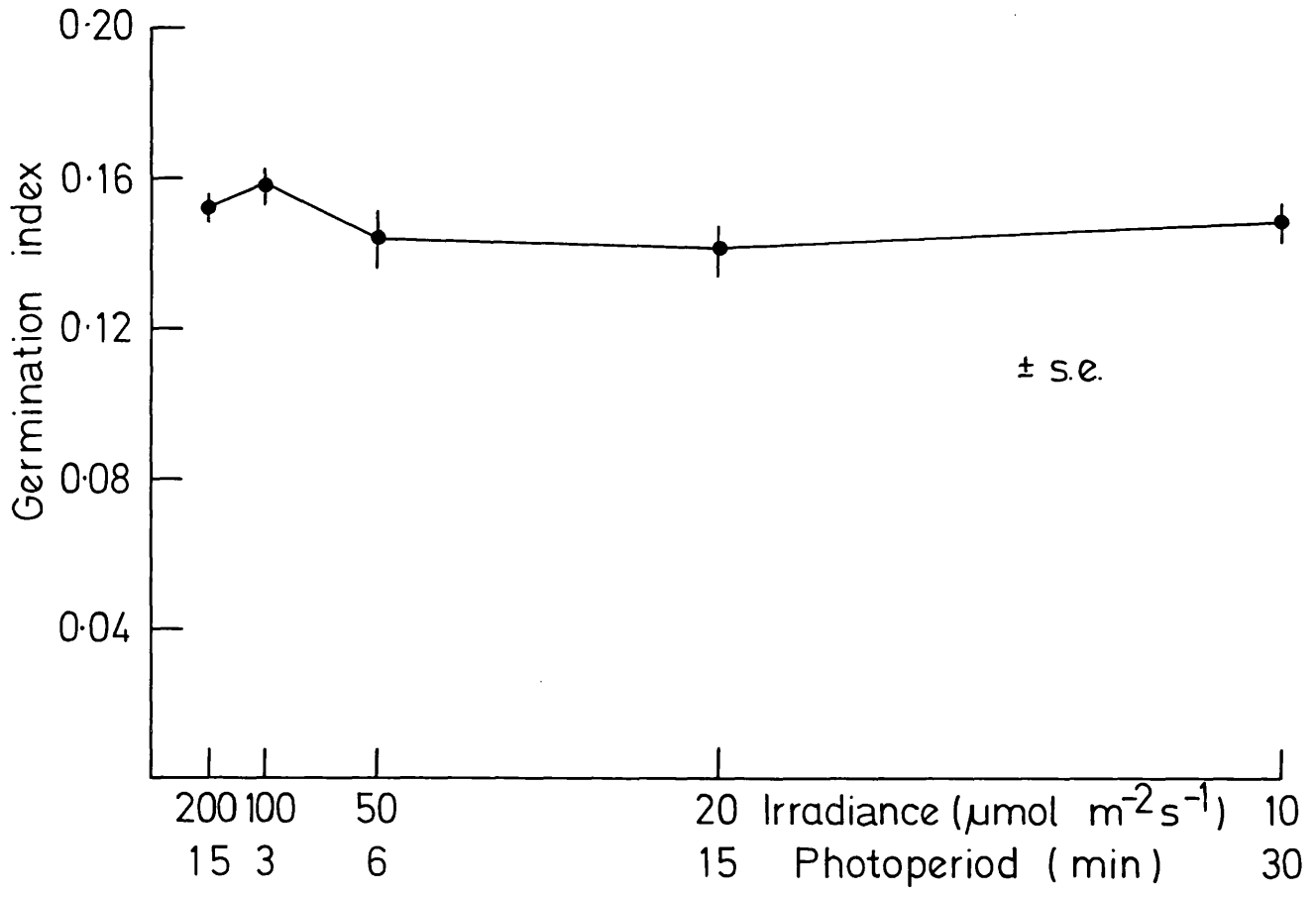
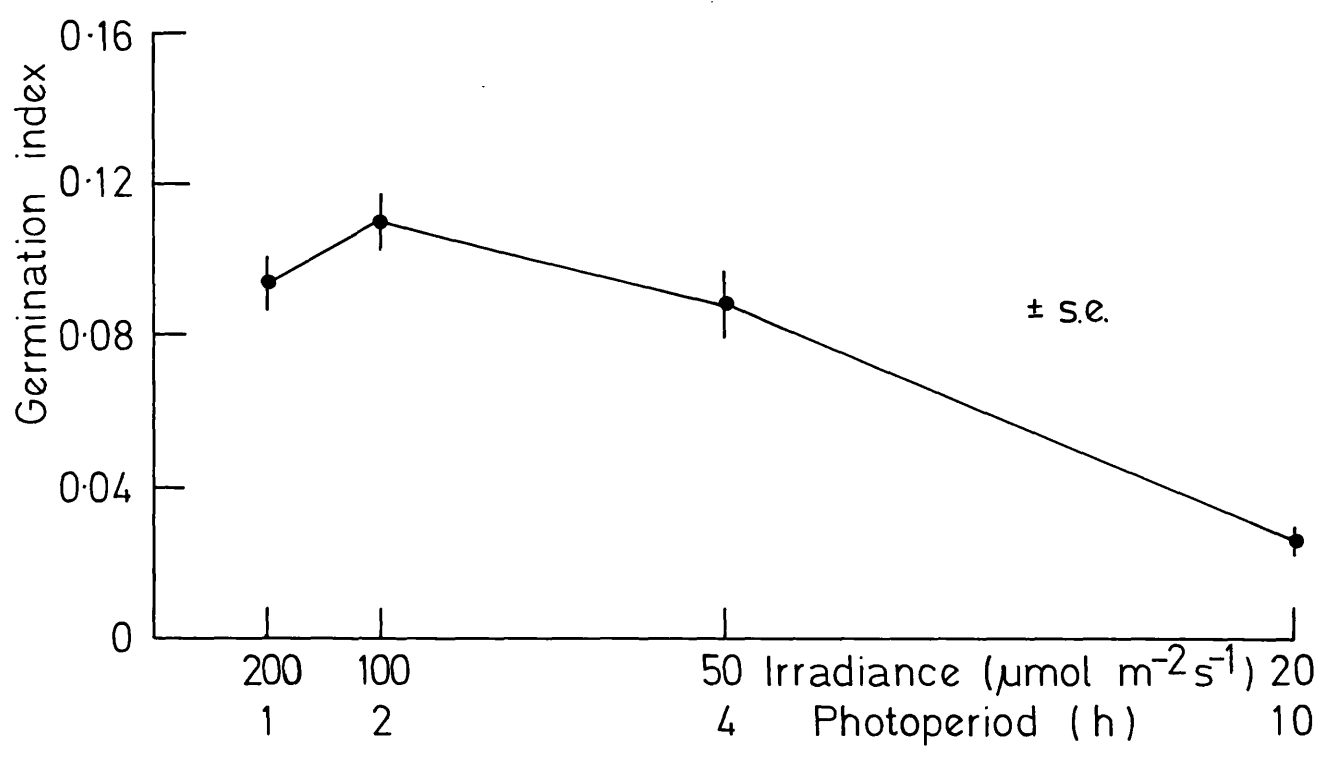

fig. 2 : 4b



using intermittent irradiation treatments. In a preliminary experiment it was found that 10 x 6 mins. irradiations given over 10h causes the same degree of photoinhibition as 10h continuous photoperiods, even though the photon fluence rate was the same and each of the individual intermittent irradiations would themselves promote germination.

The frequency of the intermittent irradiations is also important. Seeds were subjected to various daily light regimes all provided at a photon fluence rate of  $40 \mu\text{mols m}^{-2} \text{ s}^{-1}$ .

1 x 30 mins. )	All provide equal total fluence of $720 \text{ mmols m}^{-2}$
)	
2 x 15 mins. )	
)	
3 x 10 mins. )	
)	
5 x 6 mins. )	
)	
1 x 8 h )	

The results (fig. 2 : 5) shows that increasing the number of intermittent irradiation treatments within the 8h period causes greater photoinhibition of germination and eventually mimics the effect of continuous irradiation. It can also be seen that the effect is not a true photoperiodic phenomenon.

This indicates that time dependency is related to the loss of long dark periods in which any promotive effect of light can be transduced into germination processes, and that any further irradiation will interrupt these dark processes. This in turn suggests that while the light is on the processes leading to germination are being inhibited even during short promotive irradiations.

Since photoinhibition of germination is fluence rate dependent, and since Pfr in seeds is thought to be stable, it is reasonable to assume that photoinhibition is somehow related to the cycling rate of phytochrome (H) (Bartley and Frankland, 1982). Also since the dark periods appear to be important to allow germination then it is unlikely

fig. 2 : 5

Germination response of U. urens to different light regimes set within an 8h photoperiod. Photon fluence rate was  $40 \mu\text{mols m}^{-2} \text{s}^{-1}$

fig. 2 : 6

Germination response of C. album to photoequilibrium under different photoperiods:

▲————▲ 1h d<sup>-1</sup>  
△-----△ 8h d<sup>-1</sup>  
■-----■ 16h d<sup>-1</sup>  
●————● (8 x 1h) d<sup>-1</sup>  
○————○ 24h (continuous)

fig. 2:5

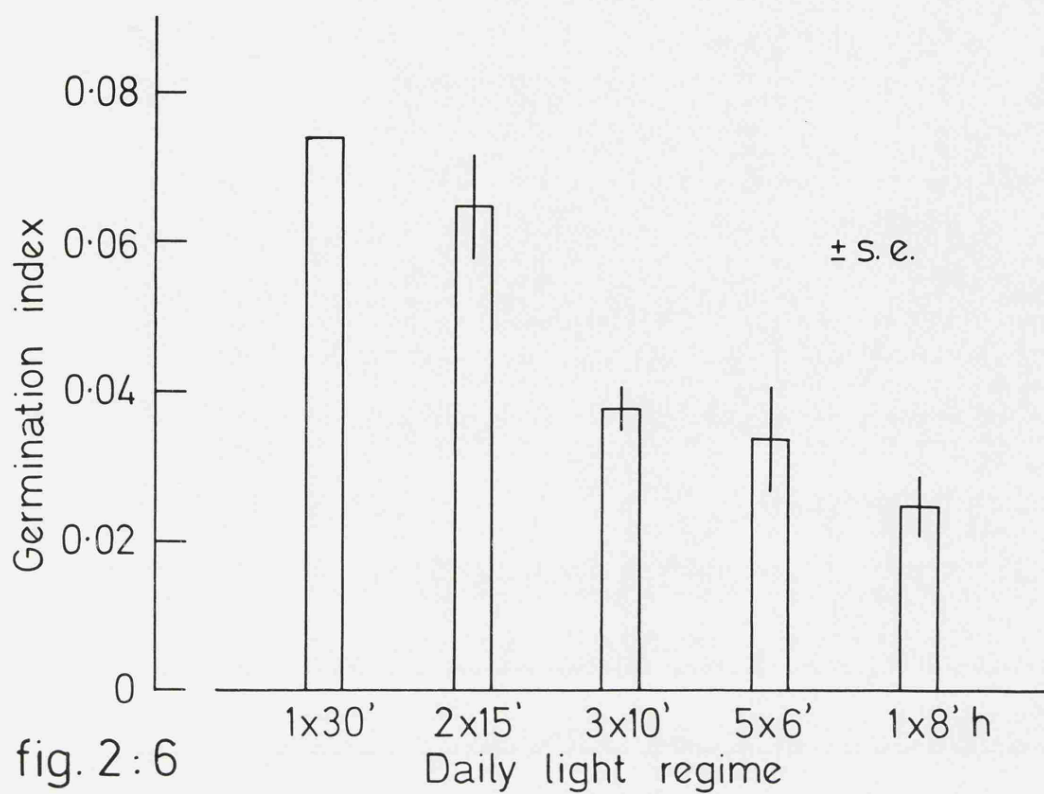
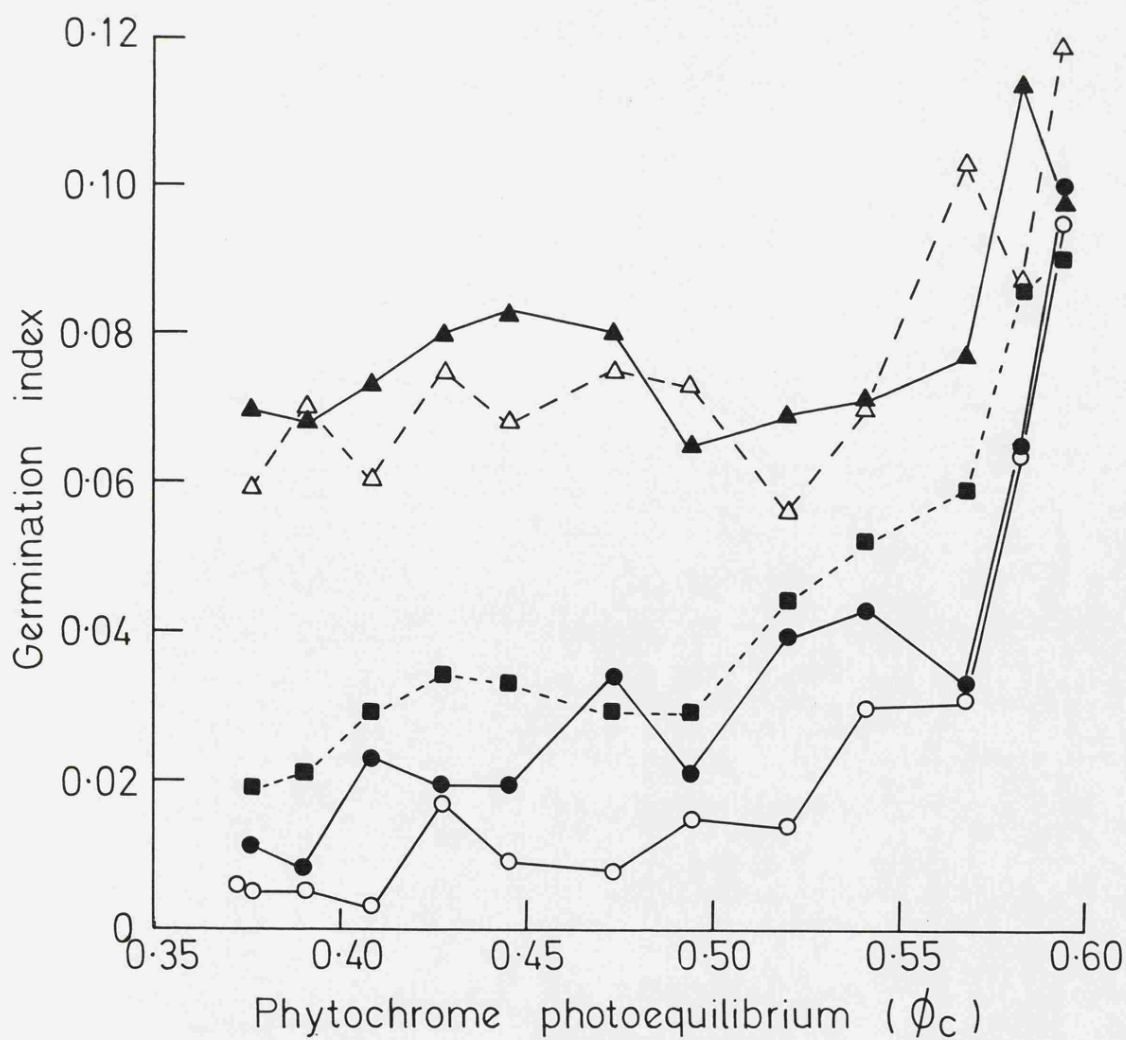

fig. 2:6



that photoinhibition is caused by H per se but rather by some process related to or controlled by H; e.g., the accumulation of phytochrome intermediates, thereby reducing the effective Pfr concentration; or, of some inhibitor which blocks the processes leading to germination. If so, it can be deduced from the experiments on U. urens that the longer the photoperiods and the higher the photon fluence rates the more of the inhibitory factor is accumulated and the longer is the dark period required to overcome the accumulated inhibitory factor and allow the action of Pfr, generated in fluorescent WL, to bring about germination.

The effects of using light sources establishing lower photoequilibria and the possible influence on 2<sup>o</sup> dormancy induction of seeds held under inhibitory conditions will be discussed later. It is also important not to disregard the possible effects of blue light in the process and this will also be studied later.

b) Chenopodium album

In preliminary experiments C. album appeared to be insensitive to photoperiod or photon fluence rate at least under fluorescent WL ( $\phi_c = 0.67$ ), except that some light was required to promote germination. The problem was studied further using the  $\zeta$  gradient since it was expected that photoinhibition might be more noticeable under low  $\zeta$ .

Different light regimes were given with a photon fluence rate of  $50 \mu\text{mols m}^{-2} \text{s}^{-1}$  PAR. The treatments were:

- 1) Continuous light
- 2) 16h day<sup>-1</sup>
- 3) 8h day<sup>-1</sup>
- 4) 1h day<sup>-1</sup>
- 5) 1h (8 x day<sup>-1</sup>) :- 1 h light, 3h dark, 1h light, 3h dark etc.

The results (fig. 2 : 6) are rather erratic due to the old age of the seed but nevertheless are in agreement with the work carried out on

U. urens. Under long photoperiods (i.e., continuous and 16h day<sup>-1</sup>) germination was high at  $\phi_c$  above 0.55 but was markedly reduced below this value. By comparison, under short photoperiods (i.e., 8h day<sup>-1</sup> and 1h day<sup>-1</sup>) germinability was maintained at a fairly high level, even under light providing low  $\phi_c$ , although interestingly germination was again markedly higher above  $\phi_c = 0.55$ . The daily 8 x 1h light regime caused low germinability approaching that of the continuous light treatment and is lower than the 8h day<sup>-1</sup> treatment which provides the same total fluence. Again this indicates the importance of a time-dependent process.

The results indicate that the HIR effects are enhanced when photoequilibrium is low and when there is a high total photon fluence, since both factors tend to reduce germination. When the total fluence is reduced then the HIR is less effective at causing photoinhibition. It is, therefore, quite probable that the sharp transition of germinability which occurred at  $\phi_c \approx 0.55$  in some species could at least in part be simply an artefact caused by the light source used. On the other hand this itself may be the mechanism which allows a seed to detect shaded situations.

Obviously different species have different sensitivities to photoinhibition of germination. For example U. urens shows inhibition of germination under prolonged, high photon fluence rate, fluorescent WL whereas it is necessary to add appreciable quantities of supplementary far-red light in order to inhibit the germination of C. album under similar conditions. Another species which is more sensitive to photoinhibition than either U. urens or C. album is the normally dark-germinating species A. caudatus.

c) Amaranthus caudatus

An action spectrum for the photoinhibition of A. caudatus seed germination was calculated for the wavelength range 649 - 771 nm. The

seeds were imbibed in darkness for 8h to allow the germination processes to start and then given a 24h light treatment prior to counting germination. It should be noted that in order to detect differences in photoinhibition, germination was counted before maximum germination was achieved. This led to large variation in the results despite attempts to keep all experimental conditions as constant as possible. Regression lines of the dose-response curves for each of the wavelengths used are shown in fig. 2 : 7. The action spectrum is plotted as the  $\log_{10}$  photon fluence rate which allows 10% germination and shows peak activity of photoinhibition at about 700 - 710 nm (fig. 2 : 8). The data is not sufficiently precise to make strong conclusions about the nature of the photoreceptor but the peak appears to be in between the peaks for cycling rate under monochromatic sources and for light absorption by Pfr. It is, therefore, probably not an LER response or simply due to phytochrome cycling alone. The curve is similar to other HIR action spectra and could be explained as a combination of the effects of both phytochrome cycling rate and the level of Pfr concentration or photoequilibrium. The basis for this would be that higher phytochrome cycling rates cause greater photoinhibition of germination and that this activity is enhanced at low Pfr levels or antagonised at high Pfr levels. Although the action spectrum indicates the involvement of phytochrome in the photoinhibition of seed germination, the limited wavelength range used means that it is not possible to preclude the involvement of any other pigment.

If it is assumed that phytochrome is the only photoreceptor involved in the photoinhibition of seed germination then it is reasonable to assume that the degree of photoinhibition at any wavelength or for any broad-band source should be predictable. In theory the slope of the line describing the germination response against  $\ln. H$  should be constant for all wavelengths but the intercept

fig. 2 : 7

Dose-response plot linear regressions for germination of  
A. caudatus under monochromatic light sources.

This page : 649 - 700 nm

over page : 707 - 771 nm

fig. 2:7 ( 649 nm - 700 nm )

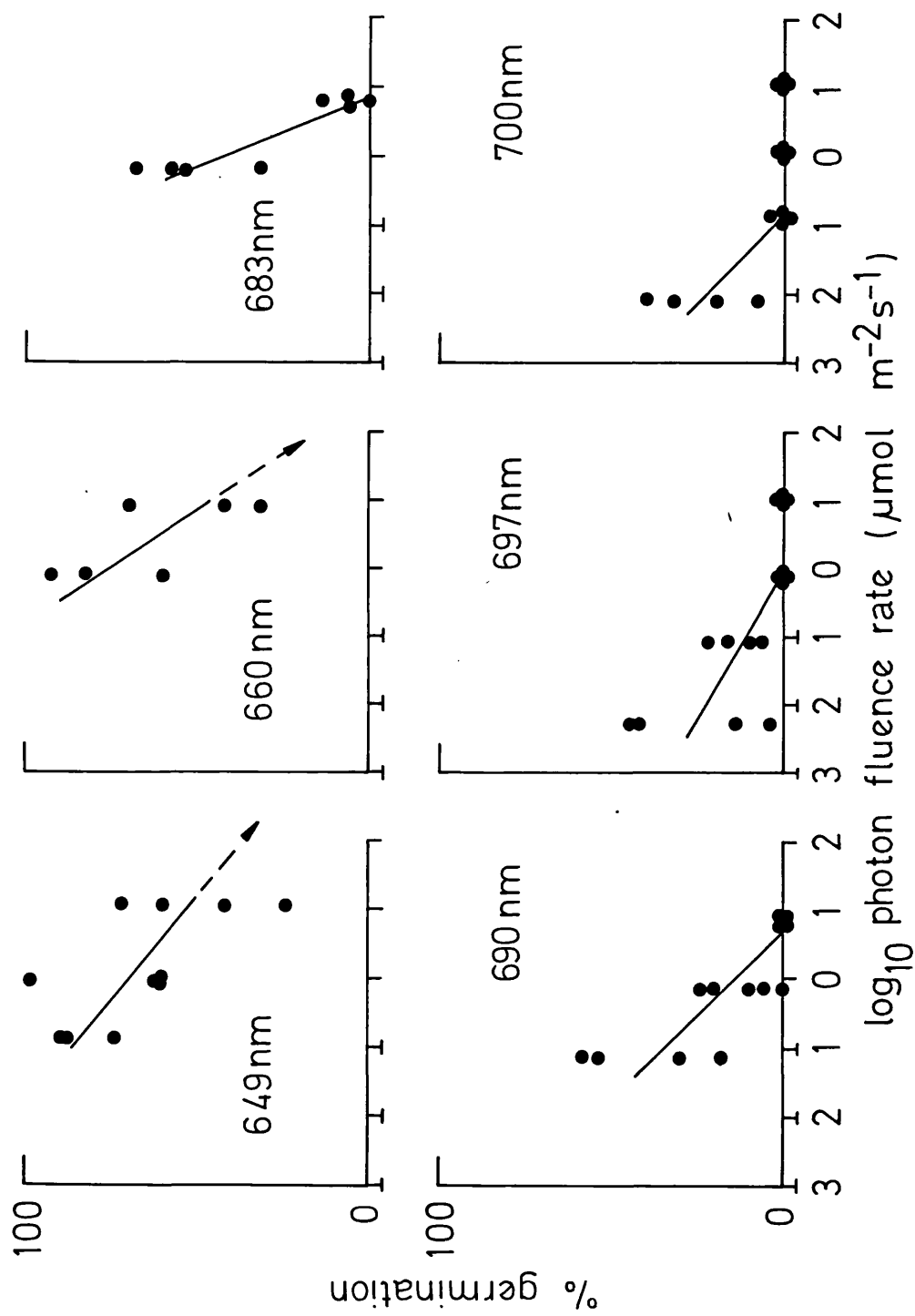

fig. 2:7 (707nm - 771nm)

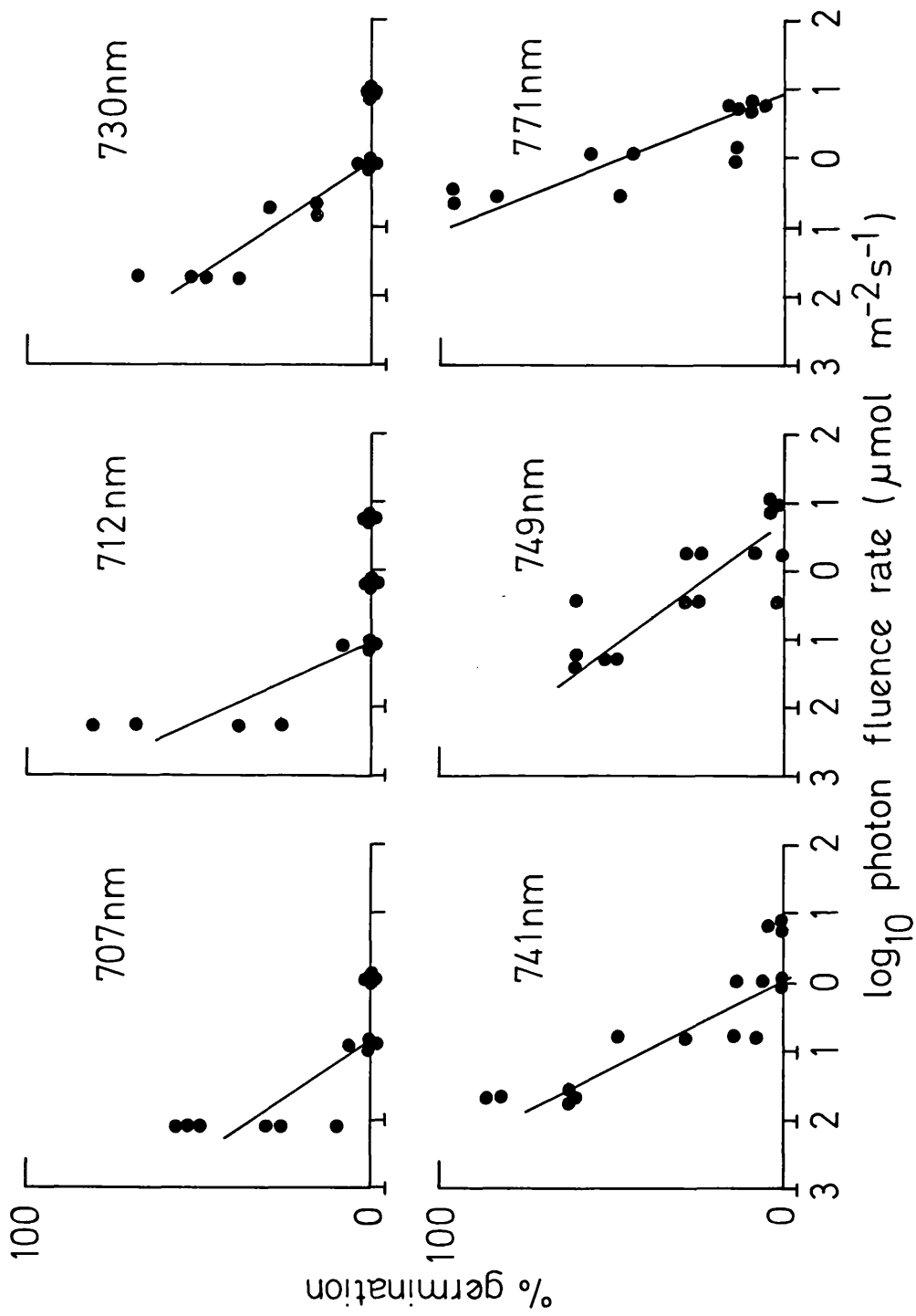
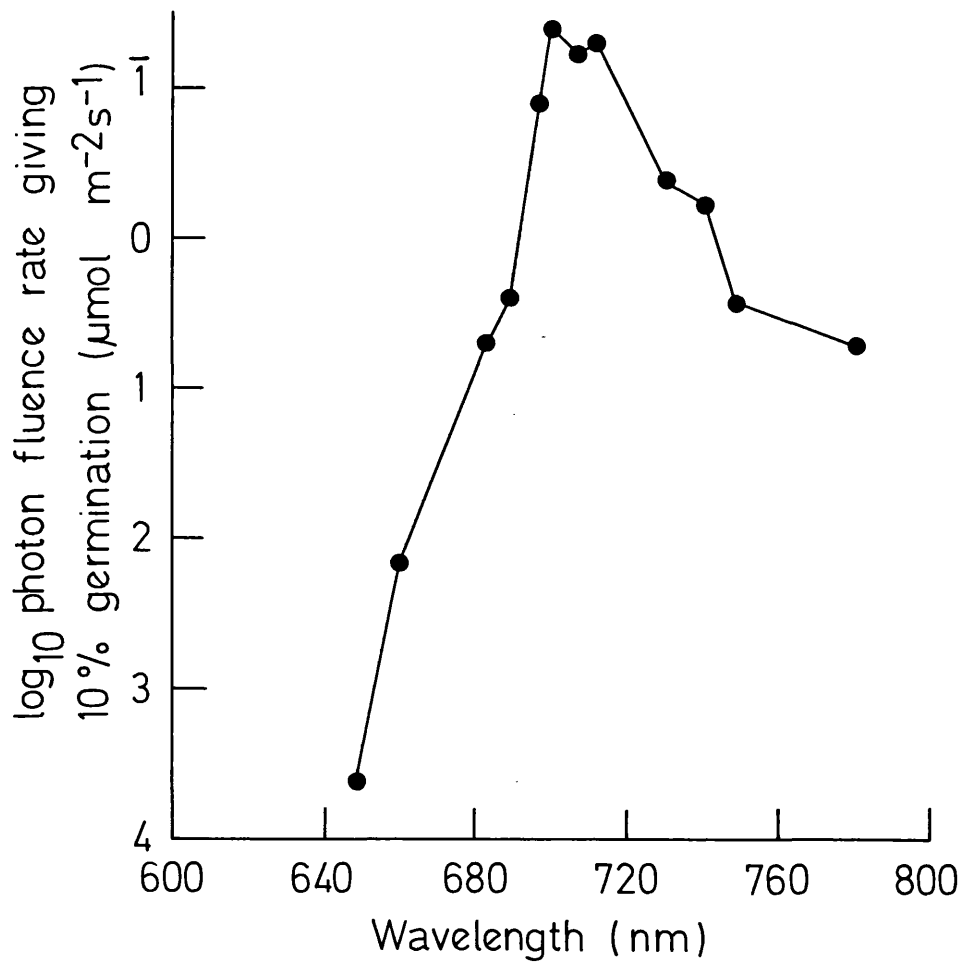

fig. 2 : 8

Action spectrum of photoinhibition of A. caudatus seed  
germination.

fig. 2:8



value should vary depending on photoequilibrium (Bartley & Frankland, 1983). There are reasons why such a relationship may not hold throughout the 400 - 800 nm waveband : 1) the influence of photoequilibrium may not be linear throughout its possible range, and 2) another photoreceptor may share responsibility for causing photoinhibition of germination. The second possibility was investigated.

In a preliminary study seeds were exposed to different waveband mixtures at different photon fluence rates. Seeds were imbibed for 8h in darkness, then irradiated for 24h prior to counting germination. It was found that a linear relationship between  $\ln H$  and % germination existed for each waveband but that the slope and position of the line varied according to the light source (fig. 2 : 9).

The least steep slope was that from the red and far-red mixture which established  $\phi_c = 0.624$ . With the fluorescent WL and far-red mixture ( $\phi_c = 0.744$ ) photoinhibition of germination was greater and also the slope was steeper. Since the latter light source actually establishes a higher photoequilibrium than the red and far-red mixture the results suggest that some component of the fluorescent WL caused an additional inhibitory action. Blue light was tested and found to be highly inhibitory to germination. Despite the low photoequilibrium ( $\phi_c = 0.251$ ) which must be responsible for much of the photoinhibition, the fact that the steepness of the slope is greatest for the blue waveband suggests that a separate blue absorbing pigment may be involved.

A more rigorous experiment was performed to test the hypothesis for the activity of a blue absorbing pigment. A red plus far-red source and a blue source were set up so that photoequilibrium would be the same in each treatment when the light transmission of A. caudatus testas were taken into account. A range of similar photon fluence rates were used for both wavebands and seeds were irradiated for 24h after

fig. 2 : 9

ln. H versus germination response relationships for A. caudatus  
under various light sources:

- ▲ red and far-red light ( $\phi_c = 0.624$ )
- fluorescent white light and far-red ( $\phi_c = 0.744$ )
- blue light ( $\phi_c = 0.251$ )

fig. 2:9

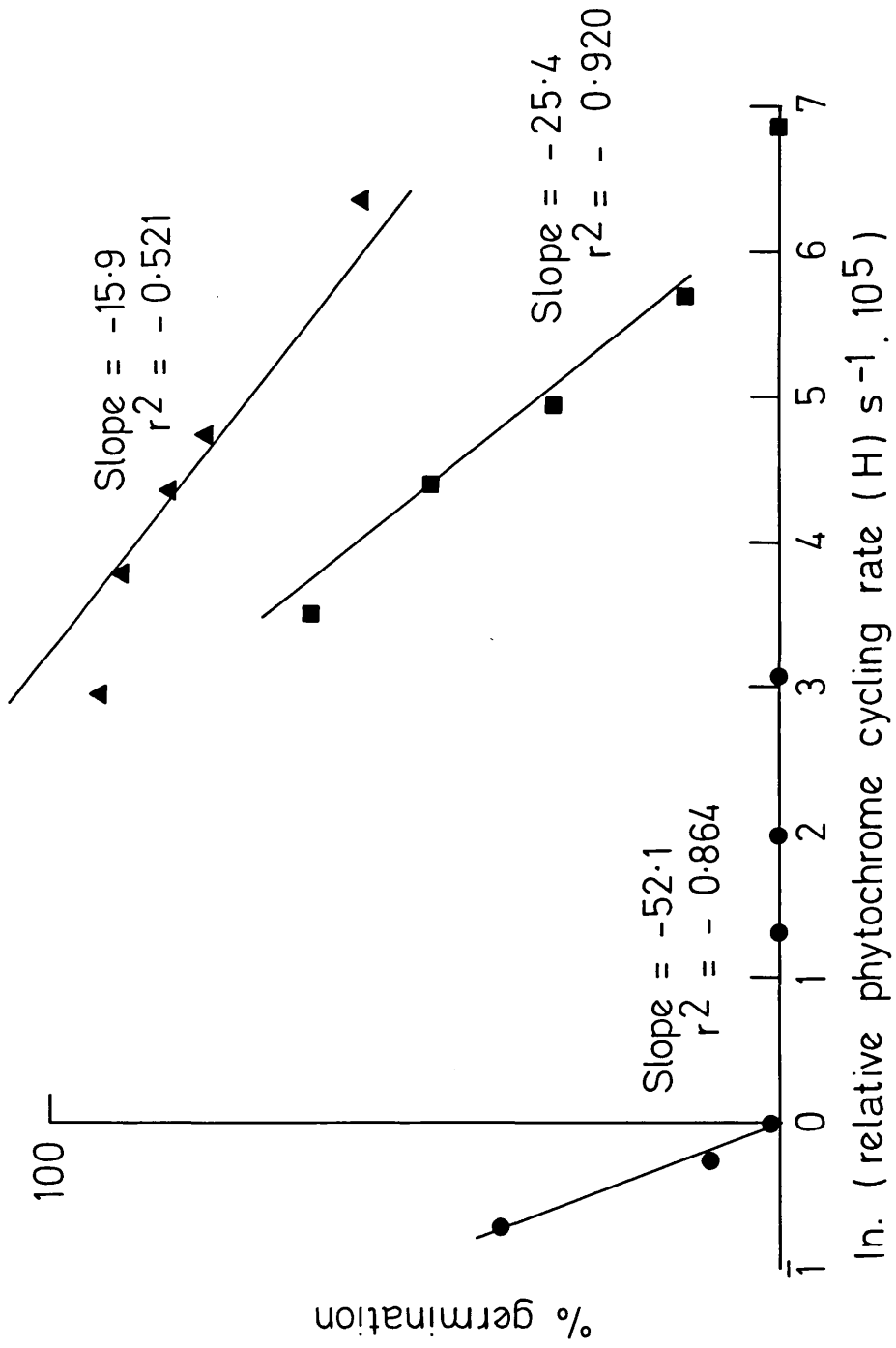

8h dark imbibition. Percentage germination was then determined and plotted against  $\ln. H_t$  (where  $t$  signifies testa adjustment).

The results (fig. 2 : 10) show that the two treatments give different degrees of photoinhibitory action. The slope for the blue treatment is steeper than for the red and far-red treatment and complete inhibition of germination occurs at a value of  $H$  of  $0.00414 \text{ min}^{-1}$ . In the red plus far-red treatment the same ( $0.00414 \text{ min}^{-1}$ ) cycling rate still allowed 60% germination. The regression line of the red and far-red treatment should not, strictly, be extrapolated, but if it is assumed that a linear relationship really exists then complete inhibition would be expected to occur at a value of  $H$  of  $0.07151 \text{ min}^{-1}$  which is greater than an order of magnitude higher than for the blue treatment. The slight difference in  $\phi_c$  (0.39 for blue, 0.41 for red and far-red) was considered to be negligible relative to such a large difference in phytochrome cycling rate required for complete inhibition of germination. Thus there is evidence for a separate blue absorbing pigment which can cause photoinhibition of germination although there is no evidence of the nature of the molecule.

For species such as A. caudatus where the testa transmits a relatively high proportion of blue light then the separate effects of blue light must be taken into account if the germination responses to a given light source are to be predicted. Conversely, for a species such as C. album in which the testa transmits little, if any, blue light this should be unimportant in controlling germination. Thus, it is necessary to have some knowledge of the light transmission properties of the testa in order to predict or explain fully the response of a seed to light.

## Dormancy Induction under various light regimes

### 3. Light quality and primary dormancy

Taraxacum officianale and C. album plants were grown under fluorescent WL ( $50 \mu\text{mols m}^{-2} \text{s}^{-1}$  PAR) until anthesis and 10 of each species were selected and transferred to each of 3 cabinets 1 and 4 ( $\phi_c = 0.69$  and  $0.35$  respectively) for seed set. Seeds were harvested when dry and stored in darkness until some of the initial dormancy was lost.

Seeds were imbibed in 3 cabinets 1, 2, 3 and 4 and also in darkness until germination was complete (figs. 3 : 1, 3 : 2).

In both cases seeds matured under high photoequilibrium showed higher germination under all light sources and darkness compared to those matured under low photoequilibrium. Either maturation under low photoequilibrium positively causes an increase in primary dormancy, or conversely does not allow the full potential of the seed to develop during maturation. If reduced germinability was simply an effect of the ratio of Pfr/Ptot in the seed then one would expect germination to proceed in the same manner once photoequilibrium had been established, resulting in no difference between the maturation treatments. On the other hand, if the total amount of phytochrome differed depending on the light quality during maturation then this might be expected to have some effect on germination.

### 4. Light quality and secondary dormancy

C. album and Rumex obtusifolius seeds have a light requirement for germination but are inhibited from germinating if the light source establishes a low photoequilibrium. Seeds of both species were incubated under inhibitory light sources (fluorescent WL with supplementary far-red) or in darkness, for prolonged periods and then transferred to fluorescent WL to promote germination. Two inhibitory light sources were used :

fig. 3 : 1

Germination response to photoequilibrium and darkness of  
C. album seeds matured under different light qualities.

■ photoequilibrium ( $\phi_c$ ) during maturation = 0.69

● photoequilibrium ( $\phi_c$ ) during maturation = 0.35

fig. 3 : 2

Germination response to photoequilibrium of Taraxacum  
officinale seeds matured under different light qualities.

■ photoequilibrium ( $\phi_c$ ) during maturation = 0.69

● photoequilibrium ( $\phi_c$ ) during maturation = 0.35

fig. 3:1

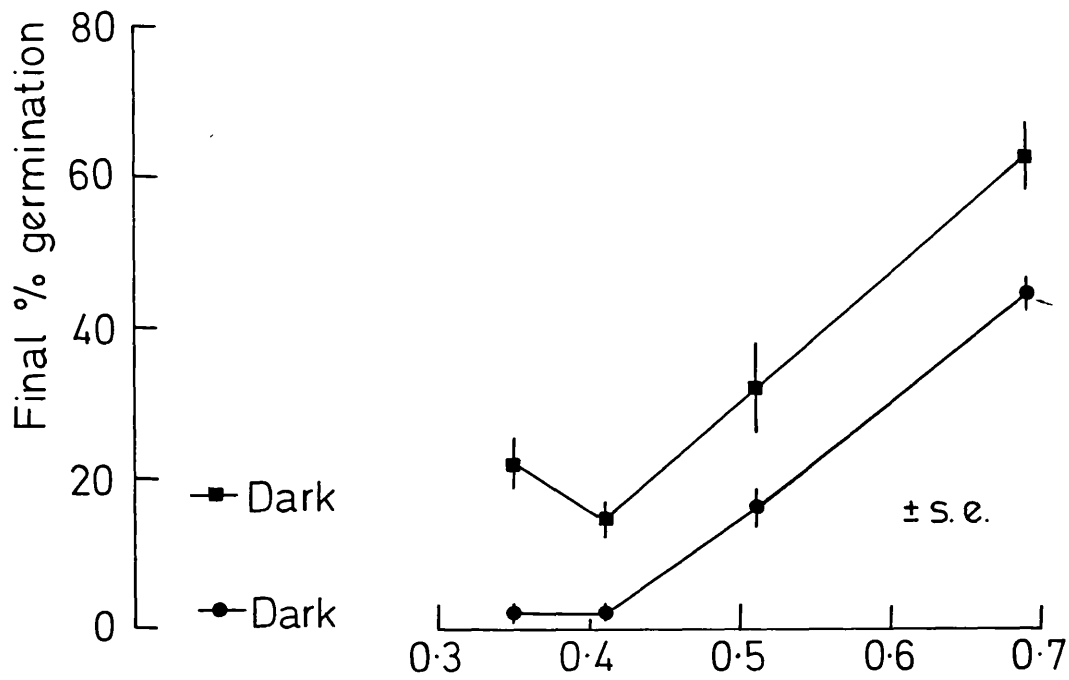

fig. 3:2

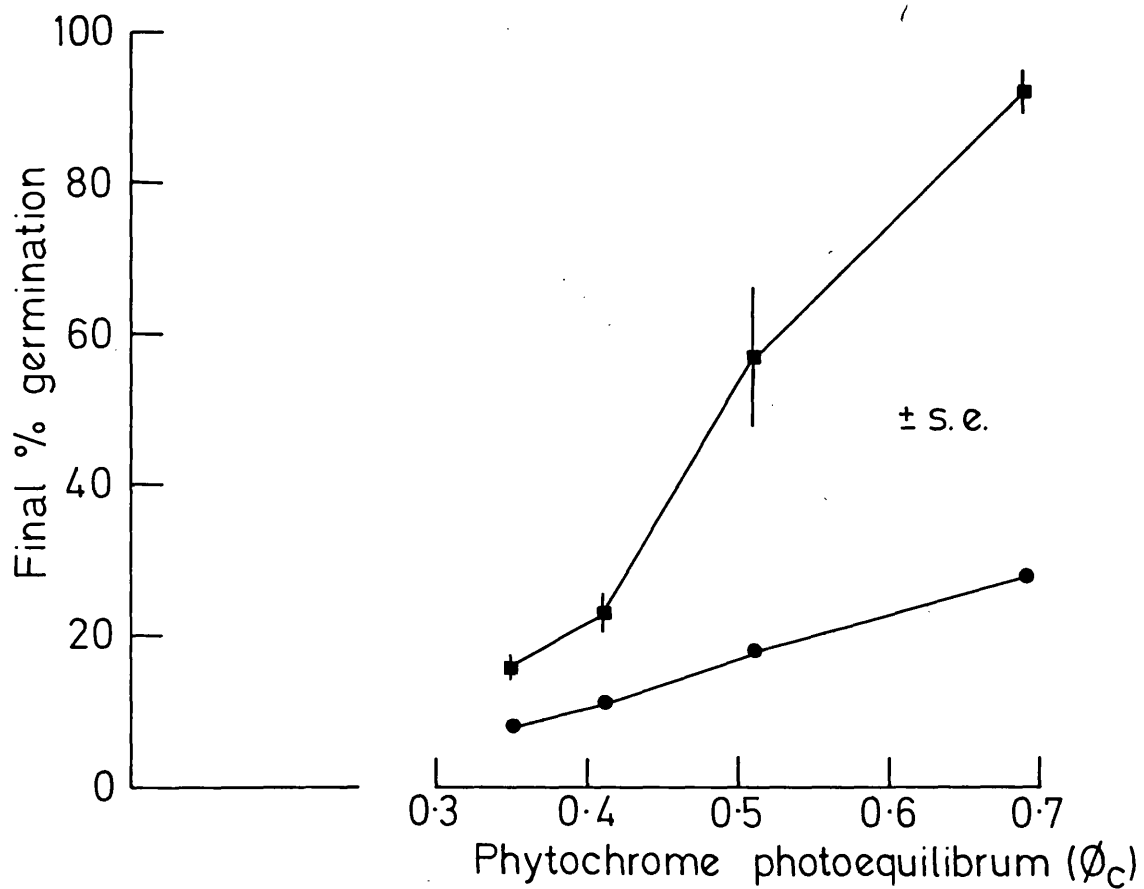

fig. 4 : 1

Induction of secondary dormancy (measured as the response to fluorescent white light) in seeds incubated under different light regimes.

●—● Dark → fluorescent white light

▲—▲ } cabinet 3 → fluorescent white light

■—■ } cabinet 4 → fluorescent white light

a - Rumex obtusifolius

b - C. album

fig. 4:1a

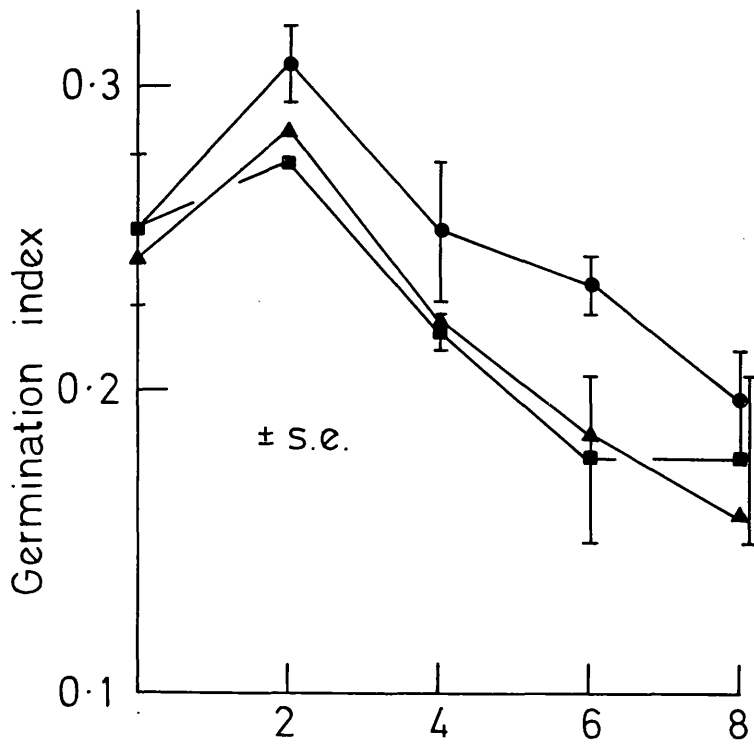
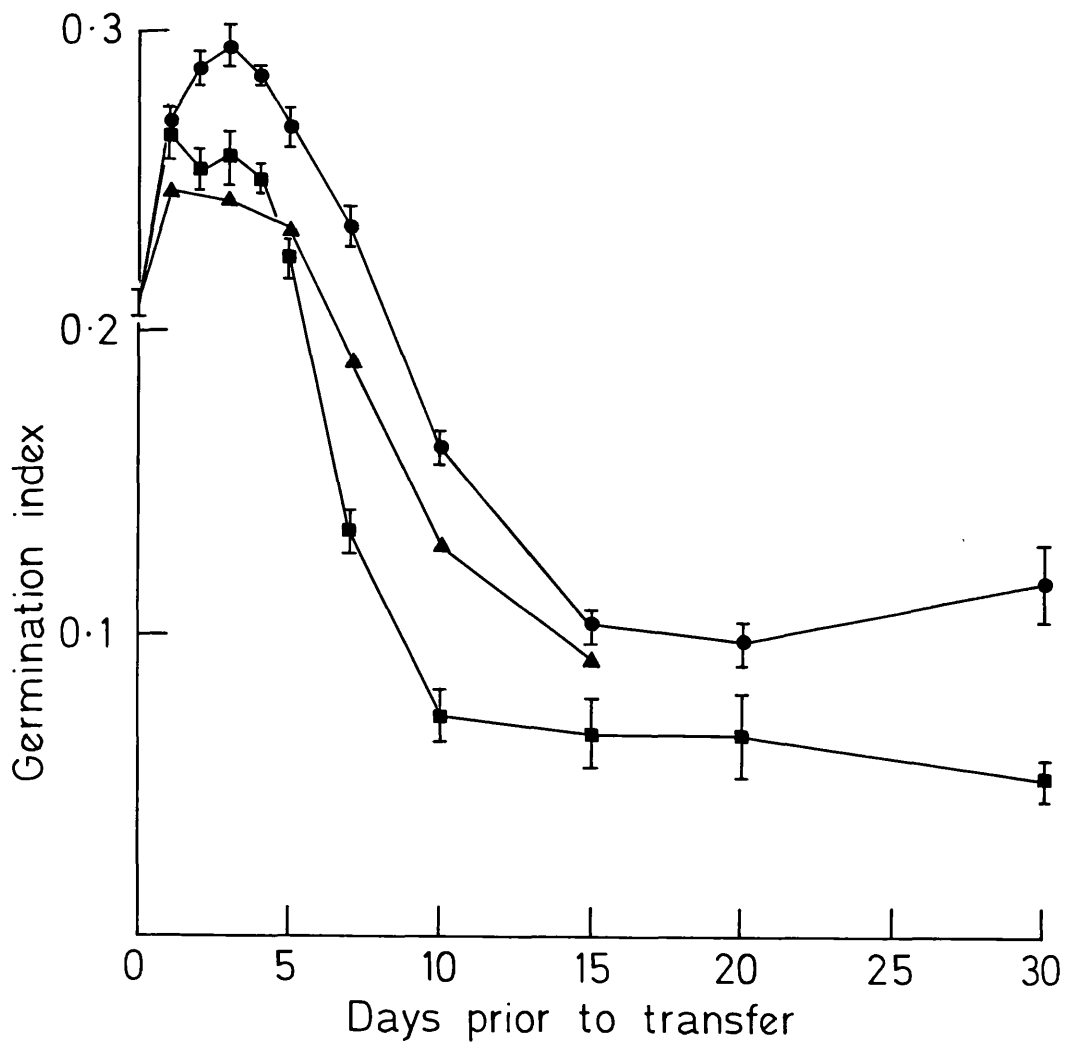

fig. 4:1b



$\zeta$  cabinet 3,  $\phi_c = 0.38$

$\zeta$  cabinet 4,  $\phi_c = 0.28$

Germination index was calculated from the time of transfer and any seeds that had germinated previously were disregarded so that only the germination response to promotory light was measured. The results are shown in figs. 4 : 1a (R. obtusifolius) and 4 : 1b (C. album). However this system creates an artefact whereby it appears that a few days under inhibitory conditions causes an increase in germinability. This is probably not the case, rather the seeds are simply better prepared to respond to germination-promotory conditions after they have been imbibed a few days and the seed is metabolically active.

Under all conditions seeds of both species became increasingly dormant with prolonged incubation prior to transfer, but dormancy developed more slowly in darkness than in light. With R. obtusifolius no difference in the rates of secondary dormancy induction was found between  $\zeta$  cabinet 3 and  $\zeta$  cabinet 4, whereas with C. album dormancy was induced faster in  $\zeta$  cabinet 4. Since secondary dormancy developed faster in the light than it did in darkness, and the total photon fluence rate (400 - 800 nm) is greater in  $\zeta$  cabinet 4 than in  $\zeta$  cabinet 3 then it is important to distinguish whether the difference between the two light sources, in inducing secondary dormancy, is due to the establishment of different photoequilibria or different photon fluence rates (or both).

To determine whether photon fluence rate is an important factor in the induction of secondary dormancy of C. album, seeds were incubated at two different photon fluence rates ( $208 \mu\text{mols m}^{-2} \text{s}^{-1}$  and  $34 \mu\text{mols m}^{-2} \text{s}^{-1}$ , in the 400 - 800 nm range) with photoequilibrium kept constant at  $\phi_c = 0.42$ . The seeds were transferred to fluorescent WL after increasing periods, as in the previous experiment.

The results (fig. 4 : 2) show that no difference in the rate of

fig. 4 : 2

Effect of photon fluence rate on induction of secondary dormancy  
(as measured by response to fluorescent white light) in C. album seeds.

Photoequilibrium ( $\phi_c$ ) = 0.42.

●—● 34  $\mu\text{mols m}^{-2} \text{s}^{-1}$

■—■ 208  $\mu\text{mols m}^{-2} \text{s}^{-1}$

fig. 4 : 3

Effect of light ( $\phi_c = 0.346$ , PAR = 50  $\mu\text{mols m}^{-2} \text{s}^{-1}$ ) on induction  
of secondary dormancy (as measured by response to darkness) in  
A. caudatus seeds.

fig. 4:2

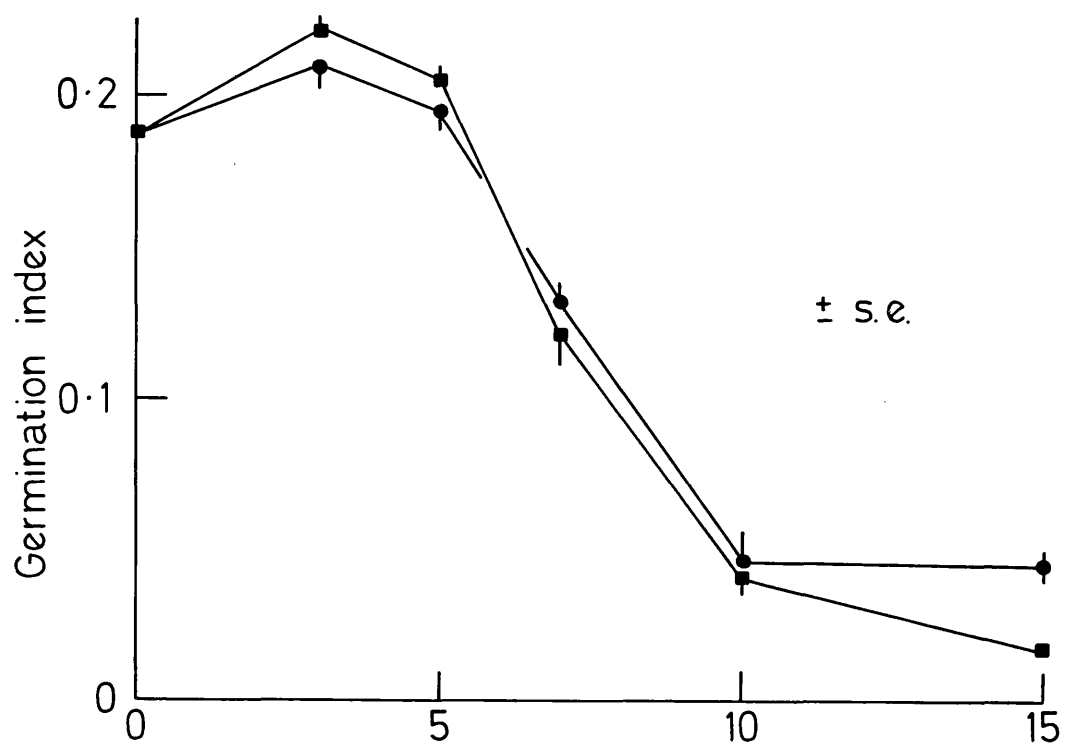
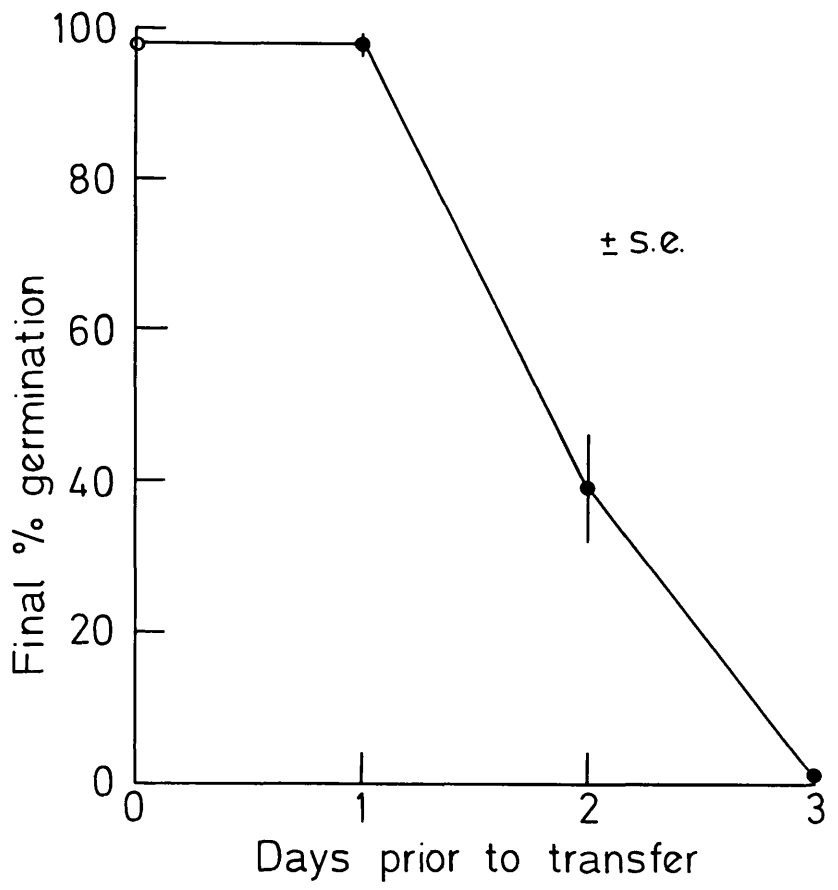

fig. 4:3



Strictly speaking this work with A. caudatus may not represent differences in secondary dormancy but simply reflect germination in response to various Pfr levels established by the light treatment.

secondary dormancy induction was found between the treatments. The result indicates that for C. album it is photoequilibrium which determines the extent of secondary dormancy. As with the germination tests under different photon fluence rates, C. album seeds appear to be insensitive to the irradiance for inducing secondary dormancy.

Amaranthus caudatus is a dark germinating species and is sensitive to light. Complete photoinhibition of germination may occur under fluorescent WL.

A. caudatus seeds were incubated under a light source (fluorescent WL plus supplementary far-red) establishing  $\phi_c = 0.346$  for 1, 2 and 3 days prior to transfer to darkness. Induction of secondary dormancy (fig. 4 : 3) was complete within 3 days, so 2 day treatments were used for measuring the effects of dormancy-inducing light conditions. It should be noted that since secondary dormancy is developing rapidly at around 2 days there is a large source of error inherent in this method.

Seeds of A. caudatus were incubated in a  $\zeta$  gradient set up in Fison Cabinet No. 2 at the Botanic Gardens. After 2 days the seeds were removed to darkness and later the final germination was counted. The results (fig. 4 : 4) show a linear relationship between  $\phi_c$  and secondary dormancy as measured by the germination percentage. Deeper dormancy was induced under lower photoequilibria.

Again a problem is that it is not possible to distinguish the possible effects of photon fluence rate from those of photoequilibrium.

Seeds of A. caudatus were incubated under 3 different photon fluence rates (400 - 800 nm) : 25, 92 and 186  $\mu\text{mols m}^{-2} \text{s}^{-1}$  under a light source establishing  $\phi_c = 0.346$ . After 2 days the seeds were removed to darkness and allowed to germinate. The results (fig. 4 : 5) show a linear relationship between photon fluence rate and  $\delta$  dormancy induction with greater dormancy induced under higher irradiances.

On the assumption that secondary dormancy induction is under

fig. 4 : 4

Effects of 2 days' incubation in light establishing different photoequilibria (constant PAR of  $45 \mu\text{mols m}^{-2} \text{s}^{-1}$ ) on induction of secondary dormancy (as measured by response to darkness) of A. caudatus seeds.

fig. 4 : 5

Effects of 2 days' incubation in light of different photon fluence rates (constant  $\phi_c$  of 0.346) on the induction of secondary dormancy (as measured by response to darkness) of A. caudatus seeds.

fig. 4:4

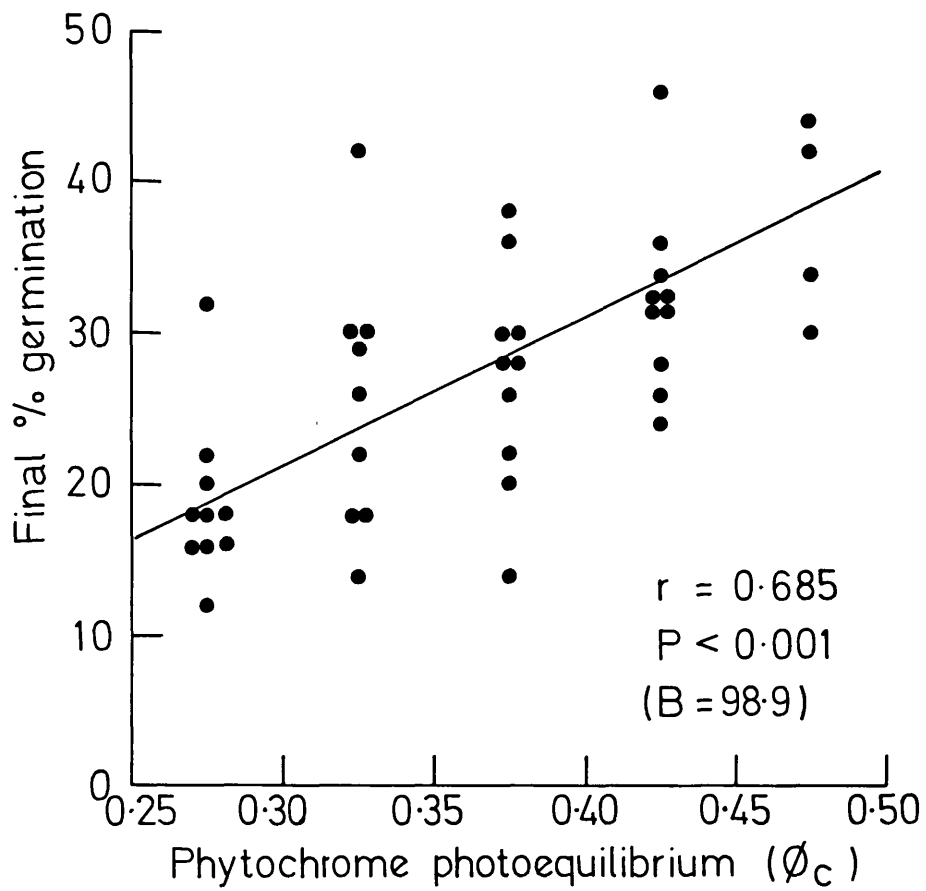
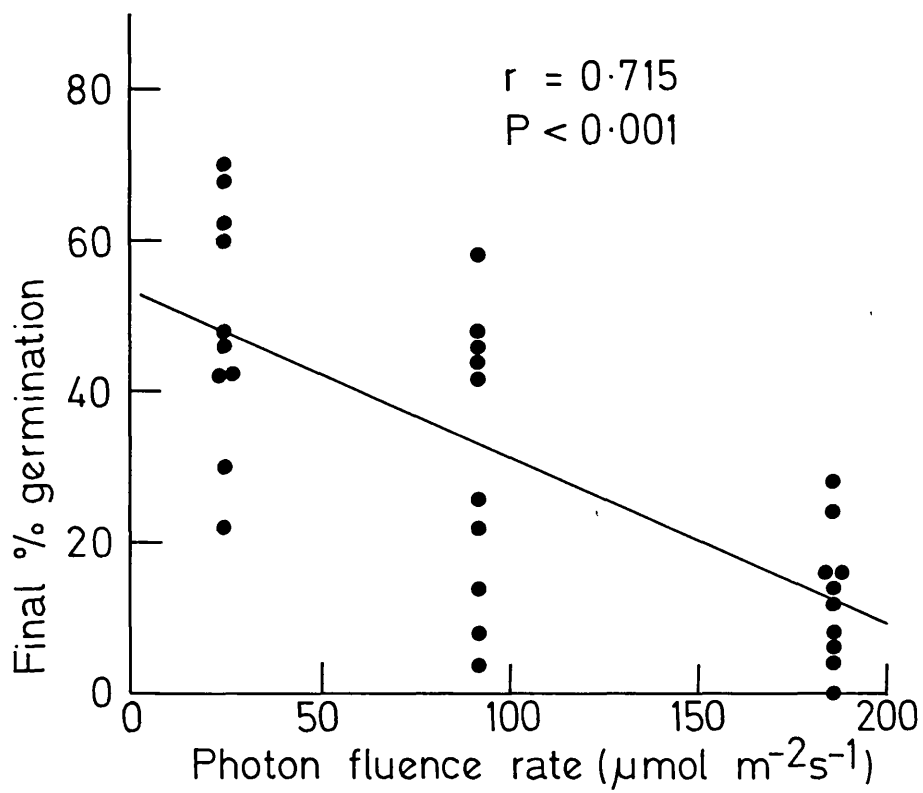

fig. 4:5



phytochrome control, seeds of A. caudatus were incubated at different heights in each of compartments 2, 3 and 4 of the  $\zeta$  cabinet such that the phytochrome cycling rate (H) should be constant in each case (nominally  $0.0101 \text{ s}^{-1}$ ), while the photoequilibrium was different, i.e.,

$$\zeta \text{ cabinet 2, } \phi_c = 0.554$$

$$\zeta \text{ cabinet 3, } \phi_c = 0.343$$

$$\zeta \text{ cabinet 4, } \phi_c = 0.208$$

Due to the nature of the light source (fluorescent WL plus supplementary far-red) the value for PAR and hence also blue light also varied :

$$\zeta \text{ cabinet 2, PAR} = 51 \mu\text{mols m}^{-2} \text{ s}^{-1}$$

$$\zeta \text{ cabinet 3, PAR} = 40 \mu\text{mols m}^{-2} \text{ s}^{-1}$$

$$\zeta \text{ cabinet 4, PAR} = 28 \mu\text{mols m}^{-2} \text{ s}^{-1}$$

Seeds were incubated for 2 days prior to transfer to darkness to allow germination. The results (fig. 4 : 6) again show that a linear relationship is found between photoequilibrium ( $\phi_c$ ) and the induction of secondary dormancy. This result is therefore similar to that seen in fig. 4 : 4 but it can be seen that the slope of the regression line in fig. 4 : 4 is steeper than that in fig. 4 : 6 although statistically this is not significant ( $t_{53} = 0.632, P > 0.5, \therefore$  slopes were not shown to differ). However the intercepts of the lines are markedly different ( $t_{53} = -5.365, P < 0.001, \therefore$  intercepts are shown to differ \*\*\*) being 5.77 in fig. 4 : 6 and -8.53 in fig. 4 : 4.

The degree of secondary dormancy found in fig. 4 : 4 (i.e., the varied  $\phi_c$ , constant PAR treatment) is greater than that found in fig. 4 : 6 (i.e., the varied  $\phi_c$ , constant H treatment). In fig. 4 : 7 both regression lines have been plotted together and the H values for each treatment shown. It can be seen that the position and slope of the regression lines is mirrored by the H values. With such small differences in H and the large source of error inherent in the method

fig. 4 : 6

Effects of 2 days' incubation in light establishing different photoequilibria (constant H of  $0.01 \text{ s}^{-1}$ ) on the induction of secondary dormancy (as measured by response to darkness) of A. caudatus seeds.

fig. 4 : 7

Regression lines from figs. 4 : 4 and 4 : 6 (constant PAR and constant H respectively) showing H values for different treatments.

fig. 4:6

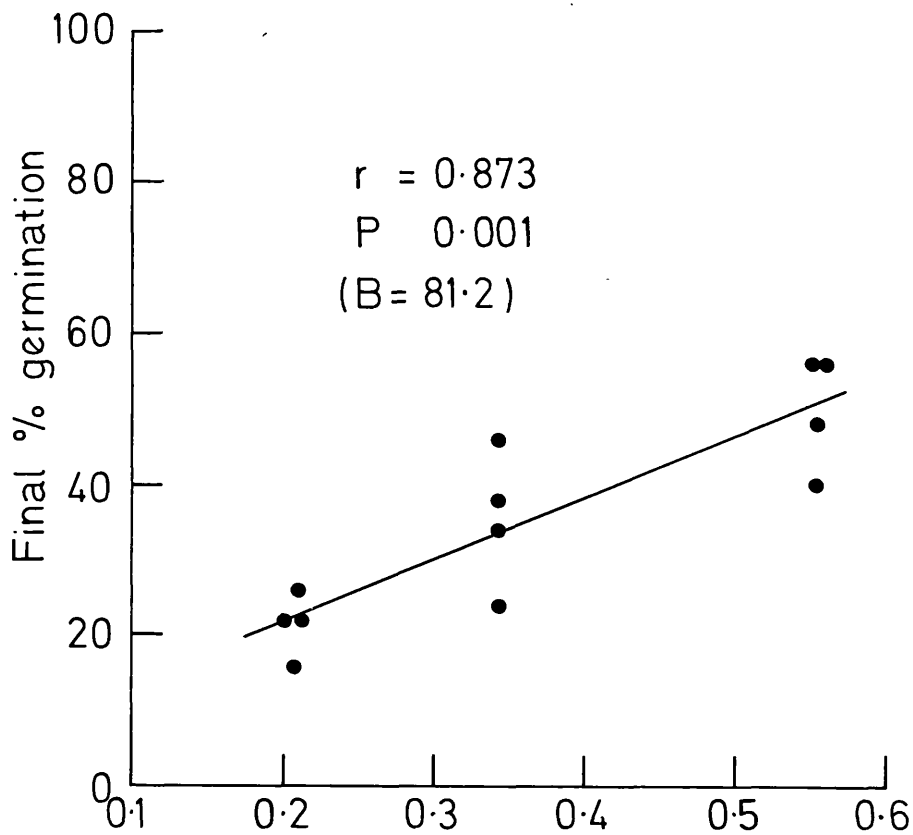
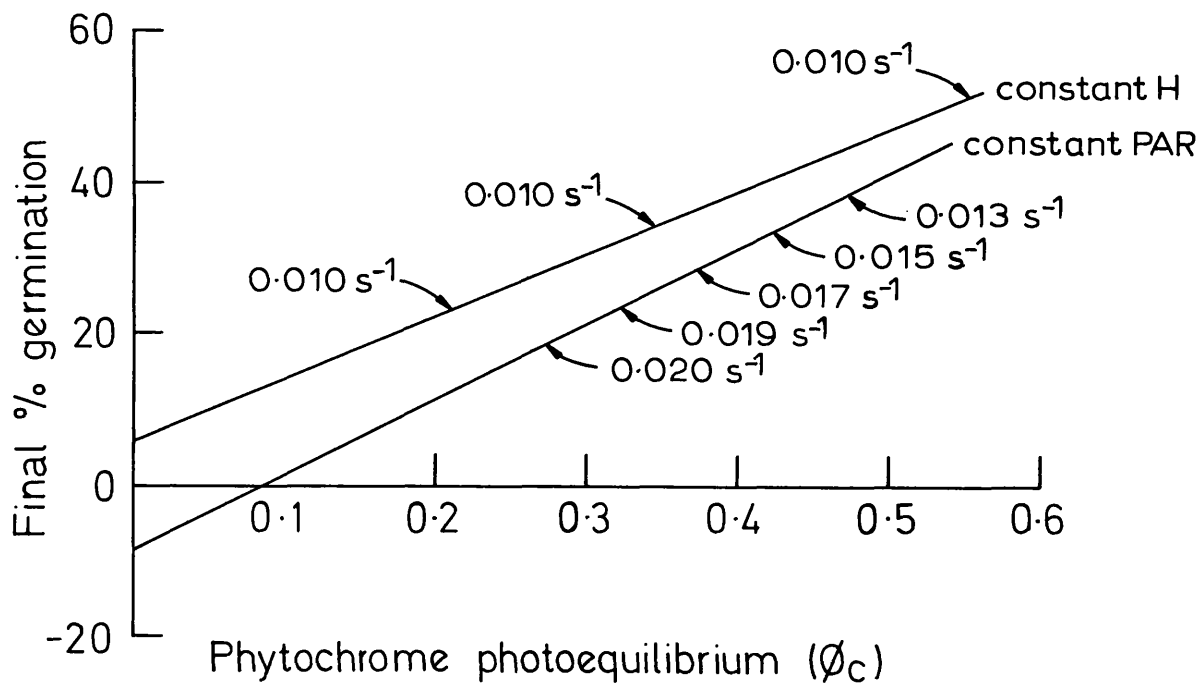

fig. 4:7



(see discussion of fig. 4 : 3) it is not surprising that the slopes are not shown to differ by statistical methods. However, since it has been shown that the induction of secondary dormancy does increase at higher photon fluence rates, and therefore with higher H, (fig. 4 : 5) it is not unreasonable to suggest that a small difference in the slopes may exist and that this is caused by the difference in H values present in the different treatments.

## Imbibition and Respiration under various light regimes

Time courses of imbibition and rates of respiration under different light regimes were made for Amaranthus caudatus.

### 5. Imbibition

Seeds of A. caudatus were set to imbibe water in light ( $200 \mu\text{mol m}^{-2} \text{s}^{-1}$  of fluorescent WL) and in darkness and the percentage water content was measured (fig. 5 : 1).

In the light treatment water uptake reached a plateau after about 12h. Only the passive phase of imbibition occurred and no seeds germinated. In the dark treatment the initial passive phase of imbibition proceeded at the same rate but after about 12h a second (active) increase occurred which leads to germination at 20 - 24h.

It would appear that the information which tells the seed that germination should not proceed (or the effect of light that inhibits germination) is perceived during the first passive phase of water uptake. Presumably, then, the "decision" to germinate or not is made during, or at the end of, the first phase of imbibition since the second (active) phase occurs as a result of the metabolic processes leading to radicle emergence. The timing of the HIR effect may depend on one of two things; either a certain water content must be reached for the HIR to occur, or some metabolic process or processes on which the HIR might act must be proceeding.

### 6. Respiration

Rates of oxygen uptake by A. caudatus seeds imbibed under various light regimes were measured by Warburg manometry.

Respiration was measured in a dark treatment and in light of sufficient photon fluence rate to inhibit germination. The results (fig. 6 : 1) show that the kinetics of respiration rate rise are similar to those of imbibition. Both light and dark treatments showed an equal rise in respiration rate up to about 12h. Here the dark

fig. 5 : 1

Imbibition kinetics of A. caudatus seeds in distilled  
water at 20°C.

▲—▲ dark

●—● light

→ radicle emergence begins

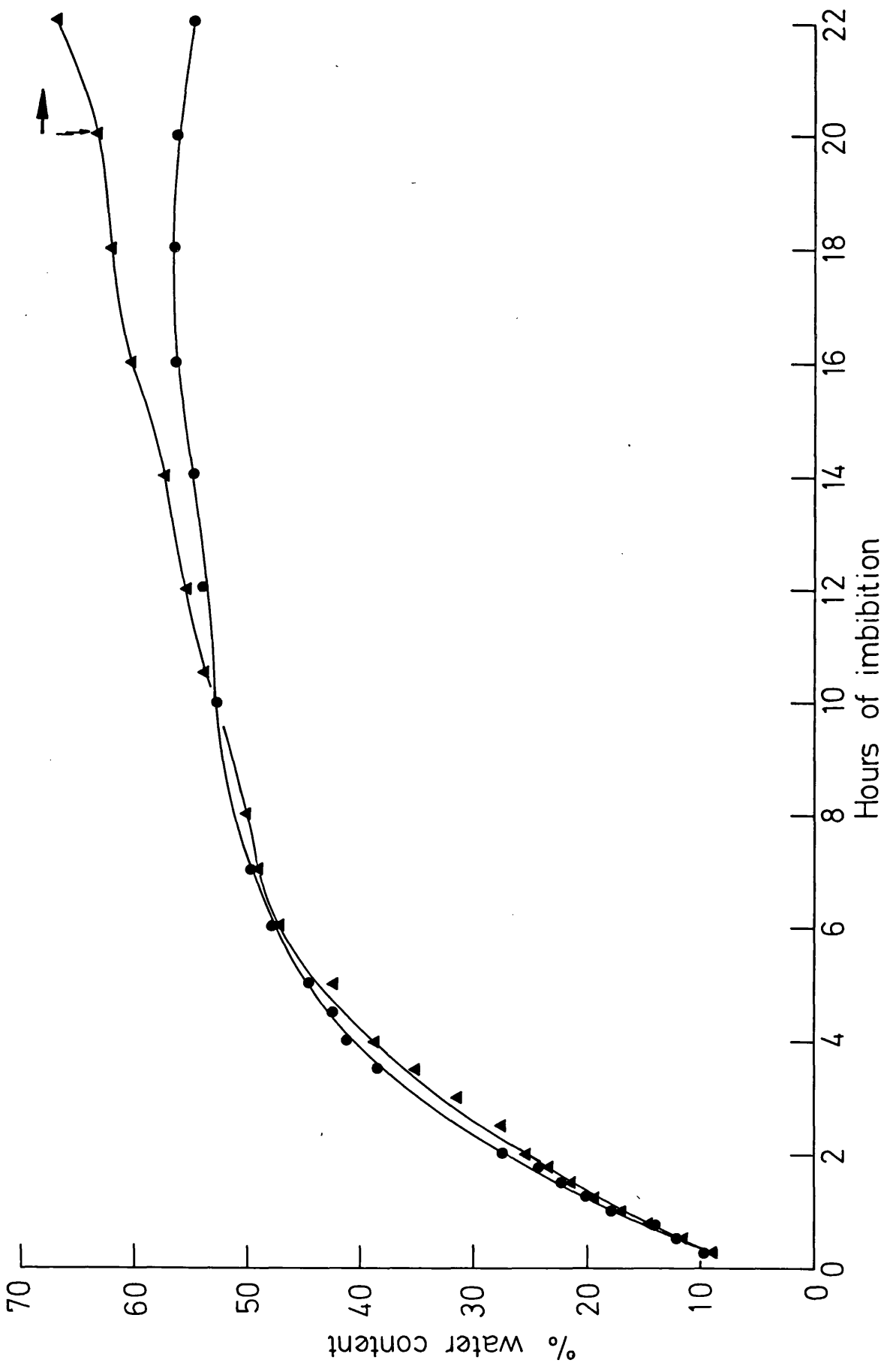

fig. 5:1

fig. 6 : 1

Respiration rates (oxygen uptake) of A. caudatus seeds  
incubated under an inhibitory light source and in darkness.

●—● dark

○—○ light

→ radicle emergence begins

fig. 6:1

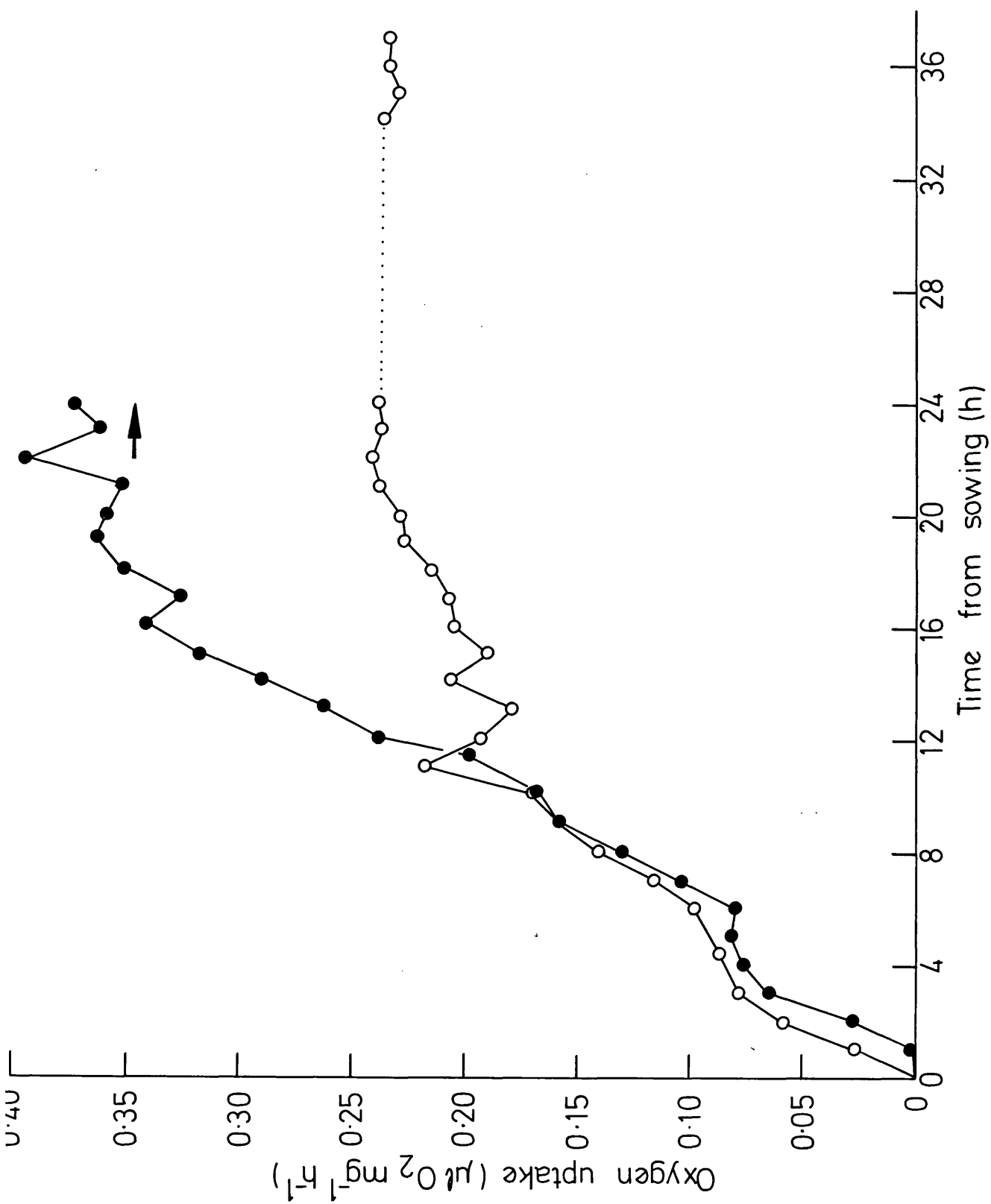

treatment shows a continuing rise in respiration which leads to germination whereas in the light the respiration rate levels off and then declines over several days.

The changes in respiration levels on returning photoinhibited seeds to darkness were investigated. Seeds were incubated under photoinhibitory conditions for 36 and 52 hours and then the lights were turned off. Respiration (oxygen uptake) was measured throughout.

The results (fig. 6 : 2) show that in both cases there is a lag period after darkness before the rate of respiration begins to rise and leads to germination. However the lag phase is longer after the seeds have been irradiated for 52h than for 36h. Presumably the lag in the respiration rise represents the induction of secondary dormancy and the slower recovery from it as the duration of the inhibitory treatment increases.

The possibility that the effects of  $\zeta$  on secondary dormancy induction may involve differences in the respiration rates of the incubated seeds was investigated. Respiration was measured in A. caudatus seeds incubated under low  $\zeta$  ( $\phi_c \approx 0.3$ ) and medium  $\zeta$  ( $\phi_c \approx 0.4$ ) over 4 days. Four hour long measurements were made centred on 12, 36, 60 and 84 hours after sowing and the mean respiration rate was plotted (fig. 6 : 3).

No significant difference in the respiration rates of the two treatments occurred except for a small increase under low  $\zeta$  after 36 hours. This suggests that the induction of secondary dormancy occurs at a fairly specific metabolic site or process and cannot be detected at the general level of the overall respiration rate of the seed.

fig. 6 : 2

Respiration rates of A. caudatus seeds under prolonged exposure to an inhibitory light source and the recovery of the seeds when the light is switched off after 36 or 52 hours.

●—● 36h light, then darkness

▲—▲ 52h light, then darkness

■—■ data from fig. 6 : 1 (first 14h of light treatment)

fig.6:2

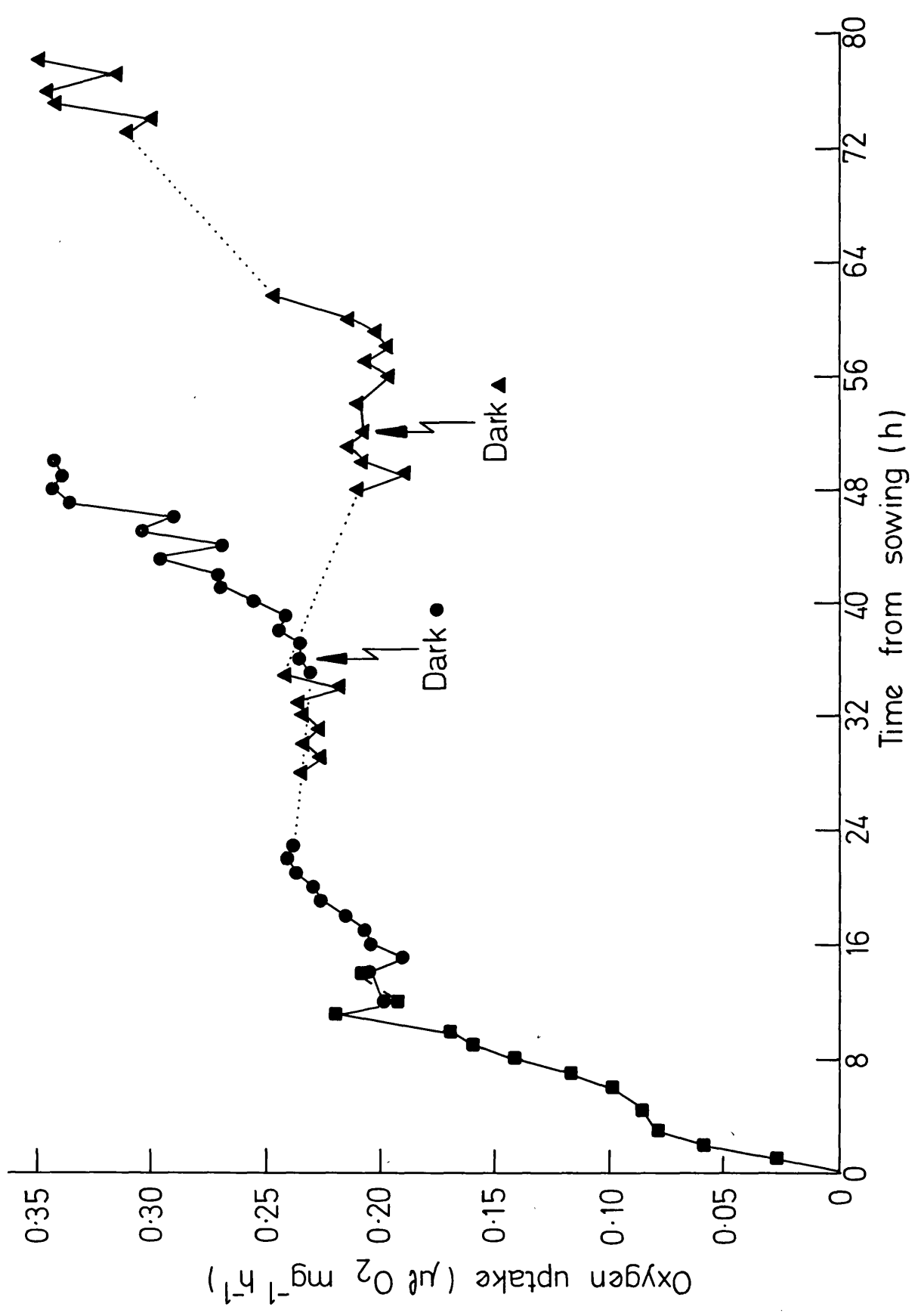

fig. 6 : 3

Respiration rates of A. caudatus seeds incubated under 2  
inhibitory light sources establishing different photoequilibria.

●—●  $\phi_c = 0.3$

▲—▲  $\phi_c = 0.4$

fig. 6:3

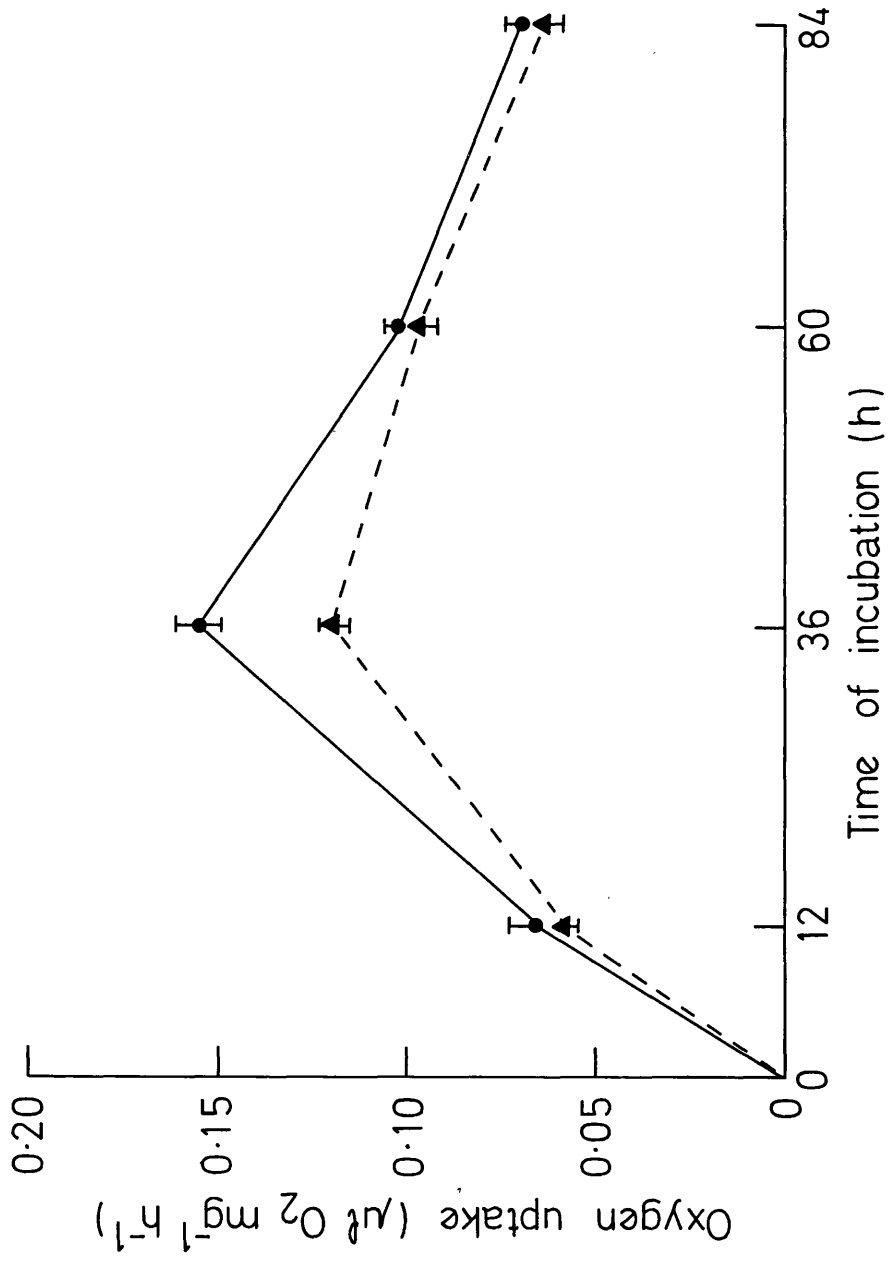

## GENERAL DISCUSSION

In the previous section the individual experiments were discussed in relation to themselves. The experiments were largely concerned with the photocontrol of germination using light sources and irradiation regimes which have some relevance to the natural environment. However, results from these experiments also need to be explained in terms of the function of the photoreceptors responsible for controlling the responses. In this section an attempt will be made to incorporate the experimental findings into what is already known about the photocontrol of germination. However, the lack of literature on the HIR photoinhibition aspect of phytochrome control means that much will be speculative. The roles of photoinhibition in respect to vegetative shade and full sunlight etc. have been considered in the literature review so I shall not repeat them here. Firstly a review of the main results will be made.

The inhibition of germination by white light has several characteristics. Photoinhibition is dependent on photon fluence rate in a log-linear manner, and phytochrome appears to be involved.

There is no evidence for Pfr destruction in seeds. At one time the stability of Pfr in seeds was considered to be due to phytochrome in seeds being, somehow, fundamentally different to that in seedlings (Kendrick et al, 1969; Spruit and Mancinelli, 1969). However, subsequent studies on the spectral characteristics of phytochrome in dehydrated tissue showed remarkable similarities with phytochrome in seeds (Kendrick and Spruit, 1974). In other words the phytochrome molecule in seeds is probably just the same as that in seedlings except that it is hydrated to a lesser degree. This raises the possibilities that Pfr stability in seeds is either the result of insufficient hydration to allow the necessary biochemical reactions for breakdown

of the molecule, or, due to the configuration of Pfr being actually more stable in the partially, or fully, dehydrated state than in the hydrated state. Whatever the reason for it, the lack of Pfr destruction means that the only way the seed can detect high fluence rates via the phytochrome system is through the action of pigment cycling (H). This is not to say, however, that pigment cycling per se is responsible for photoinhibition under high photon fluence rates; indeed it is difficult to envisage how it could be since the effects of high irradiance persist when the seeds pass into darkness. This point will be considered later. Phytochrome cycling rate must, instead, exert its effect through some process such as the accumulation of phytochrome intermediates or germination inhibitors, or possibly by some disruptive effect on membrane structure.

The accumulation of phytochrome intermediates (mostly meta Rb) increases with photon fluence rate (Kendrick and Spruit, 1973a, 1973b) and may help to inhibit germination by either restricting the availability of Pfr or by having an inhibitory effect themselves. A more satisfactory idea is that, with the phytochrome molecule acting as a membrane-associated carrier or pump, substances transferred across the membrane will activate, or stimulate production of germination inhibitors. Thus high rates of cycling would lead to greater accumulation of inhibitors which would also persist when cycling ceased.

Another possibility is that the differences between the LER and HIR may reflect a more direct effect of phytochrome on the membranes it is associated with. Pfr is known to enhance the effect of short periods of high temperature (Hendricks and Taylorson, 1972a, 1972b) which promote germination, showing that the two effects interact. Evidence was provided that the temperature shift acted through altering membrane organisation (Hendricks and Taylorson, 1976, 1978, 1979). Conversely, prolonged high temperature shifts resulted in

inhibition of germination, which was associated with cellular leakage of amino acids and, presumably, other solutes. Thus, brief disruption of membrane organisation leads to stimulation of germination, as does a short red light pulse, whereas prolonged disruption of the membrane's integrity can have deleterious effects. It could be argued then, accepting the link between phytochrome and membrane structure, that the inhibitory effect of the HIR is also caused by prolonged disruption of the membrane integrity resulting from a high cycling rate, but this is pure speculation.

Apart from dependence on photon fluence rate, photoinhibition of seed germination is also wavelength dependent. Light sources establishing low photoequilibria, (i.e., those with appreciable amounts of far-red light), cause greater photoinhibition than white light establishing higher photoequilibria (Gorski, 1975; Gorski and Gorska, 1979; Bartley and Frankland, 1982). It appears that the effect of H is enhanced by low photoequilibrium and antagonised by high photoequilibrium (Bartley and Frankland, 1982). This idea is reflected in the action spectrum for Amaranthus caudatus photoinhibition (fig. 2:8) where the peak of activity lies between that for cycling rate of phytochrome (in vitro) under monochromatic wavelengths (Butler et al, 1964) and the absorption spectrum of Pfr. The effectiveness of H is therefore linked to the photoequilibrium established by the light source. If photoinhibition were mediated by phytochrome alone, the log. dose - response plots should be parallel for different light sources establishing different photoequilibria (Bartley and Frankland, 1982). However, phytochrome is not the only photoreceptor involved in controlling the germination of seeds, and evidence is provided (figs. 2:9, 2:10) that there is also a photoreceptor for blue light involved in the photoinhibition of Amaranthus caudatus germination. Not all seeds may be expected to be sensitive

to this blue photoreceptor since factors such as relative sensitivity to the pigment and the absorption characteristics of the testa may be involved.

The light transmission qualities of testas (fig. 1:3 a - h) all show a tendency for increased transmittance towards the far-red wavelength compared to the blue. However within this general trend there is a large variation, with Amaranthus caudatus testas transmitting light fairly evenly over the 400 to 800 nm range while others, such as Chenopodium album and Sinapis arvensis, allow only the longer wavelengths to pass through. Thus species such as C. album and S. arvensis could not be expected to show photoinhibition in blue light.

Phytochrome also absorbs blue light and attempts have been made to interpret photoinhibition by blue light through the action of phytochrome (Hartmann, 1966; Gwynn and Schiebe, 1972). In studies which have questioned the sole role of phytochrome in causing photoinhibition, however, the blue receptor shows the characteristics of an undetermined flavoprotein (Malcoste et al, 1972; Schulz and Klein, 1963).

The high irradiance response may be important in determining the germination of seeds in response to different light qualities. Seeds of 4 out of 5 species tested showed a sharp decline in germination when light sources (fluorescent white light with supplemental far-red light) established photoequilibria lower than 0.55 (fig. 1:2). The exception, Digitalis purpurea, showed virtually no change in germination over the range of photoequilibrium of 0.6 down to 0.37. The value of photoequilibrium associated with the decline (0.55) is approximately that of open daylight and it is appealing to believe that the seeds may be able to respond accurately to vegetative shade conditions. It is difficult to envisage how seeds could respond in such a manner if the only cue was the red/far-red ratio of the light, but if this information

was combined with the effects resulting from a high phytochrome cycling rate then sharp deviation from a linear response to photoequilibrium might be expected.

With the apparatus (fig. a:5) used in the experiments (as opposed to the situation in the natural environment) when photoequilibrium is lowered H is raised, and this may be expected to enhance any photoinhibitory effect. The apparatus could not be used to provide light sources which better simulated the natural environment so it is not really possible to evaluate the significance of the decline of germination at the "daylight photoequilibrium" figure. However it is interesting that such similar results were found with each species and also that germination of C. album under different photoperiodic regimes also maintained a germination decline at around a photoequilibrium of 0.55.

A further characteristic of HIR photoinhibition is that of time dependency. Long photoperiods of fluorescent white light inhibit the germination of Urtica urens more than short photoperiods and this effect is greater at higher photon fluence rates (fig. 2:2). The inhibitory effect was not truly a photoperiodic phenomenon since (a) skeleton photoperiods could not mimic the inhibitory response; and (b) the same level of photoinhibition could be achieved by long photoperiods at low photon fluence rates or by relatively short photoperiods at high photon fluence rates. Seeds of U. urens appear to be able to respond to both the LER and HIR on a daily basis (fig. 2:3). Short daily photoperiods in the order of seconds or minutes will promote germination up to the maximum after which reciprocity fails and photoinhibition shows the HIR characteristic of time dependency. Also the inhibitory effect of long photoperiods could be achieved by using intermittent irradiations, the effectiveness of which increased with the frequency of irradiations (fig. 2:5). These results show that while

photon fluence rate and the duration of irradiation are important it is the length of the dark period which is critical. This was also observed by Black and Wareing (1960) in work on Nemophila insignis seeds, where germination was proportional to the duration of darkness when the light period was kept constant. Also one hour night breaks reduced germination. Except for very long light periods, where secondary dormancy is induced, different light periods followed by constant dark periods also resulted in equal germination.

The time dependency of the dark period indicates that, in order to germinate, the photoinhibited seed needs time to recover from the inhibitory effects of high photon fluence rates and, furthermore, that longer periods are required to recover from higher fluence rates. This is consistent with the idea that some inhibitor substance, or maybe the effects of a disruptive action on the membranes, has accumulated and must be removed/repared before germination may proceed.

Unless intermediates of phytochrome are themselves inhibitory to germination, and there is no evidence to suggest they have any activity (Kendrick and de Koh, 1983) then it is unlikely that accumulation of intermediates per se could lead to the inhibition of germination. However, the reduced levels of Pfr which would result from the accumulation of the intermediates might alter the balance against the promotive action of Pfr, since there would be less Pfr available to antagonise the inhibitory effects of H. This would lead to greater inhibition during the light period to be overcome during the dark period.

When seeds are incubated under inhibitory light sources for long periods they lose the ability to germinate when they are transferred to conditions which previously would have allowed germination. In other words, those light conditions which result in photoinhibition of germination will also lead eventually to the induction of secondary dormancy if the seeds are irradiated for long periods. However, the

rate of imposition and, to some extent, the final level of secondary dormancy depends on the characteristics of the light source. Principally, imposition of secondary dormancy is greater under conditions of low photoequilibrium and high H.

Seeds of C. album require light establishing high photoequilibrium to germinate, and become dormant when incubated in darkness or when photoequilibrium is less than 0.55. The dark incubation resulted in the slowest rate of secondary dormancy induction even though Pfr concentration in the dark-incubated seeds would be lower than in the irradiated seeds (fig. 4:1b). Also, seeds incubated in zeta cabinet 4 became dormant quicker than those in zeta cabinet 3. The light source in zeta cabinet 4 establishes a lower photoequilibrium but also higher H than that in zeta cabinet 3 (for spectra see fig. a:2).

Since the rate of induction of secondary dormancy of C. album did not appear to vary under two different photon fluence rates of the same light quality, it would seem that the seed responded principally to the photoequilibrium. However, a limited response to photon fluence rate is indicated by the lesser effectiveness of darkness to induce secondary dormancy.

In Amaranthus caudatus, the increased effectiveness of higher photon fluence rates to induce secondary dormancy is readily seen (fig. 4:5), as also is the effectiveness of low photoequilibrium (fig. 4:4). There is a direct linear relationship between log. photon fluence rate and secondary dormancy. The secondary dormancy response of A. caudatus in relation to a gradient of far-red light in a fluorescent white light background (fig. a:7 for spectra) is in part caused by the fact that H is higher at the low photoequilibrium end of the gradient (figs. 4:6 and 4:7).

Photoinhibition does not always lead to rapid induction of secondary dormancy. The germination of U. urens seeds is inhibited by

continuous fluorescent white light but when seeds are transferred to darkness high germination will occur. The high photoequilibrium maintained by fluorescent white light not only antagonises the effects of high photon fluence rate but also stimulates germination when the seeds are transferred to darkness.

Blue light was shown to cause photoinhibition of A. caudatus seeds by acting through a separate photoreceptor to phytochrome. Unfortunately there was no time available to study the effect of this photoreceptor directly in a possible role in the induction of secondary dormancy. It may be interesting, however, to consider some of the indirect lines of evidence. In the other experiments mentioned induction of secondary dormancy was related to the inhibitory nature of the light source. As with photoinhibition, induction of secondary dormancy was related to photon fluence rate and inversely related to photoequilibrium. Blue light also causes photoinhibition of germination in relation to the logarithm of its photon fluence rate. Therefore it might be expected that the blue photoreceptor is also involved in the induction of secondary dormancy. In the fluorescent white light-plus-supplementary far-red light sources used in the secondary dormancy experiments there is, of course, an appreciable amount of blue light. It may be relevant that for C. album seeds in which the testa transmits no blue light, induction of secondary dormancy is unaffected by the photon fluence rate of the white light (see fig. 4:2). Conversely, A. caudatus seeds, for which induction of secondary dormancy is dependent on photon fluence rate, have testas which do transmit blue light.

A contrasting opinion arises from the work of Gaba and his colleagues. In a similar set of experiments to those described in this thesis (i.e. using blue light and a mixture of red plus far-red light arranged so that both sources established the same photoequilibrium) Gaba et al (1984) demonstrated that a blue-absorbing photoreceptor was

involved in the photoinhibition of hypocotyl elongation in Cucumis sativa. The actions of the blue-absorbing photoreceptor and phytochrome were separated on a temporal basis (Gaba and Black, 1979). However, with blue light there are not the carry-over effects of photoinhibition that are found with phytochrome-mediated growth inhibition, indicating that the blue-absorbing photoreceptor was only active while the seedlings were irradiated (Gaba and Black, 1983a, 1983b). This, they suggested, was evidence for distinct roles for the two photoreceptors; i.e., the blue photoreceptor acts as a fluence rate detector, and phytochrome as principally a light quality detector.

In seed germination the effects of blue and far-red light are indistinguishable temporally (Malcoste et al, 1972; Gwynn and Schiebe, 1972) as opposed to their effects on hypocotyl growth inhibition; perhaps a different blue photoreceptor is involved in each case. The role of blue light (if any) in induction of secondary dormancy should be studied.

Having looked at the characteristics of the HIR-mediated photoinhibition of germination it is time to consider what effects photoinhibition has on the seed. It is known that the HIR acts on those stages of the germination process after Pfr action has escaped from photoreversibility (Negbi et al, 1968; Kendrick, 1976; Frankland and Poo, 1980). Inhibitory light sources have no effect on the germination of Rumex obtusifolius or C. album if the seeds are transferred to promotory light conditions after the first 2 or 3 days of incubation (figs. 4:1a and 4:1b). Presumably (in the case of R. obtusifolius and C. album) during the first 2 or 3 days of incubation the seed imbibes water and various repairs and metabolic activities occur in preparation for germination. It is thought that the HIR inhibits radicle elongation (Chen and Thimann, 1966; Karssen, 1970b) and this process can be inhibited even at a very late stage in germination when the

growing radicle has split the outer testa and ruptured the endosperm (Karssen, 1970b).

Radicle elongation depends on the swelling of the cells and therefore a corresponding rise in the fresh weight of the seed occurs (Ching, 1972). When seeds of A. caudatus were incubated under conditions causing photoinhibition of germination the second rise in water uptake and oxygen uptake were absent (figs. 5:1 and 5:2 respectively). This indicates that the onset of radicle elongation has been prevented. The initial rises in water and oxygen uptake were the same both in darkness, which allows germination, and under the inhibitory light source.

Respiration of excised embryos from both dormant and after ripened Avena fatua grains was the same during the first 10 to 12 hours of imbibition, and both sets of embryos also had the same respiratory quotient (RQ) values (Simmonds and Simpson, 1971). In lettuce seeds (c.v. Cannington Forcing) the rate of oxygen uptake increases under phytochrome control but the timing of the increase suggests that this only occurs once the process of radicle elongation is underway (Pecket and Al-charchafchi, 1979).

The growth potential of lettuce seeds is dependent on their water relations. The changes in the growth physics seen in lettuce seeds, which vary between dormant (dark treated) and non-dormant (red light treated) seeds, occur several hours after treatment during the later stages of germination (Nabors and Lang, 1971a, 1971b).

It is possible that the HIR photoinhibition of seed germination acts upon the actual process of radicle elongation since there appears to be no evidence for differences in metabolic activity of dormant (or photoinhibited) or non-dormant seeds during the early stages of germination.

The evidence suggests that all control of germination is exerted

in the axial growth stage yet this is obviously not so since the inductive action of a red light pulse is completed during the early stages of germination. The problem is that the research tends to be done on already-growing embryos. Also the early metabolic events induced by Pfr may be of such a specific nature, or in such a few cells of the embryo, that they may be indistinguishable from the background metabolism using the general techniques employed. Nevertheless, there is evidence of control during the radicle growth stage so it can be assumed that photoinhibition may act on this process to prevent continued growth.

To re-iterate, there are two stages during germination where light control is exerted (Frankland and Poo, 1980). The first depends on a minimum level of hydration (Berrie et al, 1974; Hsiao and Vidaver, 1970) and is mediated through the LER system. For a light-requiring species this stage is, more or less, simply a light detection process since it may be satisfied even by far-red light (Taylorson, 1972). The second stage mediated through the HIR, on the other hand, is capable of perception of the quality and quantity of light in the environment and transducing these signals into information concerning the advisability of germination. If conditions are not good for a high chance of seedling survival then the seeds will pass into secondary dormancy.

It is not possible, as yet, to sort out cause and effect between the increases in water and oxygen uptake and growth. However the work of Nabors and Lang on the growth physics of lettuce seeds which shows that growth of the radicle depends on its water relations suggests that control of water uptake may be of principal importance.

Changing from a state of hydration to one of dehydration is obviously a fairly common occurrence to seeds in soil. It is important that seeds should avoid damage during these transitions. Berrie and Drennan (1971) showed with oat and tomato seeds that an hydration/

dehydration cycle was not injurious providing meristematic activity was not occurring in the embryonic axis. If dehydration occurs before the second phase of water uptake then no damage occurs, but deleterious effects worsen the longer dehydration is delayed after the start of the second phase. It is interesting, then, that seeds of A. caudatus (fig. 5:1) showed no second phase of water uptake when photoinhibited from germinating. It can be postulated, therefore, that the HIR, in somehow preventing the second phase of imbibition, protects the seeds against the damaging effects of cycles of hydration and dehydration thereby enhancing the survival prospects of the seed for several seasons.

## SUMMARY

There are two stages at which light may inhibit the germination of light sensitive seeds. The first occurs at the beginning of the germination process. Classically a red light pulse promotes germination and a far-red light pulse can inhibit (or reverse the promotive action of red light) germination. These reactions belong to a group known as low energy reactions (LER). After a period (which varies from seed to seed), red light promoted processes which lead to germination can no longer be reversed by a far-red pulse. However, even after the seed has "escaped from reversibility" by a far-red pulse, it is still possible to inhibit germination by light; irradiation of the seed must now be of high photon fluence rate and prolonged duration. The reaction comes under the heading of high irradiance reactions (HIR). The HIR acts on processes which occur later in the germination process and there is no reason to suppose that LERs and HIRs affect the same process, although they may share a common site of action.

There are two components to HIR photoinhibition. In the first, light acts through phytochrome, and in the second, light acts through a blue light absorbing receptor of unknown form.

The effects of phytochrome-mediated HIR photoinhibition are brought about by three factors; 1) photon fluence rate, 2) photo-equilibrium, and 3) time.

1) Photon fluence rate

Up to the point of saturation, inhibition of germination is logarithmically related to photon fluence rate. In the absence of evidence demonstrating Pfr destruction in seeds it is claimed that photon fluence rate effects are mediated by phytochrome cycling rate (H) (Bartley & Frankland, 1982). It is unlikely that H can itself cause photoinhibition but there are a variety of ways in which inhibition may be mediated through the effects of cycling rate.

## 2) Photoequilibrium

Photoinhibition is increased when photoequilibrium ( $\emptyset$ ) is low. Germination inhibition is not dependent only on photoequilibrium but is also modified under different photon fluence rates. Low photoequilibrium will enhance the photoinhibitory effects of high H while a high photoequilibrium will antagonise the effects of high H. However, even low photoequilibria can promote germination if the light is only given for short periods.

## 3) Time

The timing of the irradiation, frequency of irradiations, duration of irradiation, duration of dark periods etc. can all significantly affect photoinhibition. Photoinhibition increases with the duration of the light period but this is not a photoperiodic effect. Continuous light can be replaced by intermittent irradiation over the same time course, the effectiveness of which increases with increased frequency even when individual irradiations are shorter. Up to the point where prolonged irradiation induces secondary dormancy the germination levels may reflect the duration of dark periods rather than light periods.

Altogether, then, the three factors of cycling rate, photoequilibrium and time indicate that photoinhibition is really a result of interrupting/inhibiting the processes leading to germination which require darkness. This may be due to such things as accumulation of inhibitory substances, making Pfr unavailable by the accumulation of intermediates, or even by direct phytochrome-mediated alteration of membrane organisation. It is not absolutely clear whether the HIR is simply stopping the process of germination, or whether there is a more positive inhibition. The finding that germination can reflect the length of dark periods rather than the light periods might suggest that the HIR is simply stopping germination during irradiation. On the other hand the increasing effectiveness of higher frequency of intermittent irradiations, the fact

that seeds show induction of secondary dormancy with prolonged photoinhibition, and the differential effects of photon fluence rate and photoequilibrium, suggest a more positive inhibitory action. The second option is preferred.

A blue-light absorbing receptor is also involved in photoinhibition of seed germination and its influence can be distinguished from that of phytochrome even though some of the effects of blue light are bound to operate through phytochrome. The effects of both the blue light receptor and phytochrome cannot be separated temporally and so it is possible that both are acting on the same stage of the germination process. This is not to say, however, that they act in the same way or exert the same effects. The relative importance of the blue receptor for different species may be affected by such factors as concentration of, or sensitivity to, the photoreceptor. The light transmittance of the seed covering structures will also be important. Dark coloured seeds tend to transmit little, if any, blue light and so could not be expected to show much blue photoinhibition. Seeds with lighter colouring tend to transmit more blue light, and almost clear testas (such as Amaranthus caudatus) may approximate to neutral density filters. In view of this, it is important that account should be taken of the light-transmitting properties of the testa when attempting to understand fully, or to predict light-controlled germination.

After prolonged HIR photoinhibition seeds start to show secondary dormancy, i.e., they will be less able to germinate even when transferred to conditions which previously would have allowed germination. The rate of development of secondary dormancy depends on the nature of the light source causing photoinhibition. Generally, the conditions which cause the greatest photoinhibition also cause the deepest dormancy. Again, in terms of phytochrome, three factors are involved; 1) photon fluence rate, 2) photoequilibrium, 3) time.

### 1) Photon fluence rate

Where seeds are sensitive to photon fluence rate (Chenopodium album is relatively insensitive compared to A. caudatus, for example) secondary dormancy increases more rapidly under higher photon fluence rates, and does so in a linear manner. This is similar to the situation for photoinhibition and, again, is related to H.

### 2) Photoequilibrium

Incubation of seeds in light establishing low photoequilibrium for prolonged periods results in the induction of secondary dormancy. The lower the  $\phi$  value, the quicker secondary dormancy will be induced and the two parameters appear to be linearly related. Light establishing a high photoequilibrium may be able to cause photoinhibition but is not effective at causing secondary dormancy.

### 3) Time

Generally the longer seeds are incubated in inhibitory light conditions the deeper the secondary dormancy becomes. At the beginning of the incubation period, however, light is not effective in inducing secondary dormancy, suggesting that (as with photoinhibition) this activity occurs in the later stages in the processes leading to germination.

If seeds are subjected to daily light/dark cycles then the depth of secondary dormancy will increase proportionately with longer photoperiods.

It can generally be concluded, then, that the light conditions, acting through phytochrome, which cause photoinhibition also lead to induction of secondary dormancy. There are some exceptions, however, such as with Urtica urens incubated in fluorescent white light, where subsequent transfer to darkness will allow germination. There are two factors which are responsible for this; 1) the maintenance of a high photoequilibrium may prevent the induction of secondary dormancy, and

2) the high proportion of Pfr in the seed may promote germination on transfer to darkness.

It is not possible to state the action (if any) of the blue light absorbing receptor in causing secondary dormancy since no formal experiments were done to test it (due to lack of time). Some circumstantial evidence exists which suggests that the blue light absorbing receptor may have a dormancy-inducing role, although other evidence suggests it may only be active in photoinhibition itself (Gaba and Black, 1983a,b). Experiments to test the effectiveness of blue-light-induction of secondary dormancy, acting through the blue light absorbing receptor, need to be performed.

The general picture that has emerged so far, then, is that light acting on the later stages of germination can cause photoinhibition which in turn leads to secondary dormancy. This photoinhibition acts through an HIR of phytochrome (and also a blue light absorbing receptor). In terms of phytochrome the factors which are important to these inhibitory, and dormancy-inducing, effects are photon fluence rate, photoequilibrium, and time.

Apart from the fairly obvious survival advantages of not germinating under vegetative shade (principally a response to  $\emptyset$ ), or on the soil surface (principally a response to H), the real function of the HIR appears to be that, once the germination process has been stopped, the seeds are able to maintain themselves in a state of secondary dormancy and subsequently pass through cycles of hydration and dehydration without being damaged. The HIR appears to prevent seeds passing into the active stage of growth which leads to germination. Once axial growth (meristematic activity) has begun the seeds become progressively less able to withstand cycles of hydration and dehydration without deterioration.

To sum up, then, the HIR of photoinhibition of seed germination

is adapted to prevent seeds from germinating under conditions where chances of seedling survival are small, and having done that, enable the seeds to pass into a state of secondary dormancy. In this state they may remain viable for prolonged periods until more favourable conditions for seedling survival arise.

#### BIBLIOGRAPHY

- BARTLEY, M.R., and FRANKLAND, B. (1982). Analysis of the dual role of phytochrome in the photoinhibition of seed germination. *Nature*. 300 pp 750-752.
- BERRIE, A.M.M. and DRENNAN, D.S.H. (1971). The effect of hydration - dehydration on seed germination. *New Phytol.* 70 pp 135-142.
- BERRIE, A.M.M., PATERSON, J. and WEST, H.R. (1974). Water content and responsivity of lettuce seeds to light. *Physiol. Plant.* 31 pp 90-96.
- BEVINGTON, J.M. and HOYLE, M.C. (1981). Phytochrome action during pre-chilling induced germination of *Betula papyrifera*. *Plant Physiol.* 67 pp 705-710.
- BEWLEY, J.D. (1980). Secondary dormancy (skotodormancy) in seeds of lettuce *Lactuca sativa* cv. grand rapids and its release by light, gibberellic acid and benzyl adenine. *Physiol. plant.* 49 pp 277-280.
- BLAAUW-JANSEN, G. and BLAAUW, O.H. (1976). Further evidence for the existence of two phytochrome systems from two distinct effects of far-red light on lettuce seed germination. *Acta Bot. Neerl.* 25 pp 213-219.
- BLACK, M. (1969). Light controlled germination of seeds. SEB symposium 23. Dormancy and Survival. Cambridge University Press pp 193-217.
- BLACK, M. and NAYLOR, J.M. (1959). Prevention of onset of seed dormancy by gibberellic acid. *Nature* 184 pp 468-469.
- BLACK, M. and WAREING, P.F. (1960). Photoperiodism in the light inhibited seeds of *Nemophila insignis*. *J. Exp. Bot.* 11 pp 28-39.
- BOISARD, J., SPRUIT, C.J.P. and ROLLIN, P. (1968). Phytochrome in seeds and an apparent dark reversion of Pr to Pfr. *Meded. Landbouwhoges.* Wageningen 68-17 pp 1-5.
- BUTLER, W.L., HENDRICKS, S.R., and SIEGELMAN, H.W. (1964). Action spectra for phytochrome in vitro. *Photochem. Photobiol.* 3 pp 521-528.

CARPITA, N.C., NABORS, M.W., ROSS, C.W. and PETRETIC, N.L. (1979a).

The growth physics and water relations of red light induced germination in lettuce seeds (III). Changes in the osmotic and pressure potential in the embryonic axes of red and far-red treated seeds. *Planta* 144 pp 217-224.

CARPITA, N.C., NABORS, M.W., ROSS, C.W. and PETRETIC, N.L. (1979b).

The growth physics and water relations of red light induced germination in lettuce seeds (IV). Biochemical changes in the embryonic axes of red and far-red treated seeds. *Planta* 144 pp 225-234.

CHEN, S.S.C. and THIMANN, K.V. (1966). Nature of seed dormancy in *Phacelia tanacetifolia*. *Science* 153 pp 1537-1539.

CHING, T.M. (1972). Metabolism of Germinating Seeds. In: Kozlowski, T.T. (ed.) *Seed Biology II*. Academic Press, New York and London.

COOKE, R.J. and KENDRICK, R.E. (1976). Phytochrome controlled gibberellin metabolism in etioplast envelopes. *Planta* 131 pp 303-307.

CRESSWELL, E.G. and GRIME, J.P. (1981). Induction of a light requirement during seed development and its ecological consequences. *Nature* 291 pp 583-585.

CRUDEN, R.W. (1974). The adaptive nature of seed germination in *Nemophila menziesii* Aggr. *Ecology* 55 pp 1295-1305.

CUMMING, B.G. (1963). The dependence of germination on photoperiod, light quality and temperature, in *Chenopodium* spp. *Can. J. Bot.* 41 pp 1211-1233.

CURE, J.D., PATTERSON, R.P., RAPER, C.D. Jr. and JACKSON, W.A. (1982) Assimilate distribution in soybeans *Glycine max* as affected by photoperiod during seed development. *Crop Science* 22 pp 1245-1250.

DREYER, E.M. and WEISENSEEL, M.H. (1979). Phytochrome-mediated uptake of calcium in *Meugotia* cells. *Planta* 146 pp 31-39.

DUKE, S.O. (1977). Model for variable light sensitivity in imbibed dark-dormant seeds. *Plant Physiol.* 59 pp 244-249.

- DUKE, S.O., (1978a). Interactions of seed water content with phytochrome initiated germination of Rumex crispus (L.) seeds. *Plant and Cell Physiol.* 19 pp 1043-1049.
- DUKE, S.O. (1978b). Significance of fluence-response data in phytochrome-initiated seed germination. *Photochem. Photobiol.* 28 pp 383-388.
- DUKE, S.O., EGGLEY, G.H. and REGER, B.J. (1977). Model for variable sensitivity in imbibed dark-dormant seeds. *Plant Physiol.* 59 pp 244-249.
- EPEL, B.L., BUTLER, W.L., PRATT, L.M. and TOKUYASA, K.T. (1980). Immunofluorescence localisation studies of the Pr and Pfr forms of phytochrome in the coleoptile tips of oats, corn and wheat. In : De Greef, J.A. (ed.) *Photoreceptors and plant development.* Antwerpen University Press, Antwerpen, pp 121-133.
- ESASHI, Y., KURASHI, R., TANAKA, N. and SATOH, S. (1983). Transition from primary dormancy to secondary dormancy in cocklebur seeds. *Plant, Cell and Environment* 6 pp 493-499.
- EVANS, A. and SMITH, H. (1976a). Localisation of phytochrome in etioplasts and its regulation of in vitro gibberellin levels. *Proc. Natl. Acad. Sci. USA* 73 pp 138-142.
- EVANS, A. and SMITH, H. (1976b). Spectrophotometric evidence for presence of phytochrome in the endosperm of barley etioplasts. *Nature* 259 pp 323-325.
- FLINT, L.H. and MCALISTER, E.D. (1935). Wavelengths of radiation in the visible spectrum inhibiting the germination of light sensitive lettuce seed. *Smithsonian Miscellaneous Collections* 94 (5) pp 1-11.
- FLINT, L.H. and MCALISTER, E.D. (1937). Wavelengths of radiation in the visible spectrum promoting the germination of light sensitive lettuce seed. *Smithsonian Miscellaneous Collections* 96 (2) pp 1-9.
- FRANKLAND, B. (1976). Phytochrome control of seed germination in relation to the light environment. In : Smith, H. (ed.) *Light and Plant Development.* Butterworths, London

- FRANKLAND, B. (1981). Germination in Shade. In : Smith, H. (ed.) Plants and the Daylight Spectrum. Academic Press Inc. (London) Ltd. pp 187-204.
- FRANKLAND, B. and POO, W.K. (1980). Phytochrome control of seed germination in relation to natural shading. In : De Greef, J.A. (ed.) Photoreceptors and Plant Development. Antwerpen University Press pp 357-366.
- GABA, V. and BLACK, M. (1979). Two separate photoreceptors control hypocotyl growth in green seedlings. Nature 278 pp 51-54.
- GABA, V. and BLACK, M. (1983a). Photocontrol of hypocotyl elongation in de-etiolated Cucumis sativa L. Rapid responses to blue light Photochem. Photobiol. 38 pp 469-472.
- GABA, V. and BLACK, M. (1983b). Photocontrol of hypocotyl elongation in de-etiolated Cucumis sativa L. A blue-light-induced post-illumination burst of growth. Photochem. Photobiol. 38 pp 473-476.
- GABA, V., BLACK, M. and ATTRIDGE, T.H. (1984). Photocontrol of hypocotyl elongation in de-etiolated Cucumis sativus L. Long term fluence rate dependent responses to blue light. Plant Physiol. 74 pp 897-900.
- GALSTON, A.W. and SATTER, R.L. (1976). Light, clocks and ion flux : an analysis of leaf movement. In : Smith, H. (ed.) Light and plant development. Butterworth, London. pp 159-184.
- GORSKI, T. (1975). Germination of seeds in the shadow of plants. Physiol. Plant. 34 pp 342-346.
- GORSKI, T. and GORSKA, K. (1979). Inhibitory effects of full daylight on the germination of Lactuca sativa L. Planta 144 pp 121-124.
- GORSKI, T., GORSKA, K., and NOWICKI, J. (1977). Germination of seeds of various herbaceous species under leaf canopy. Flora 167 pp 289-299.
- GUTTERMAN, Y. (1973). Differences in the progeny due to daylength and hormone treatment of the mother plant. In : Heydecker, W. (ed.) Seed Ecology. Butterworths, London pp 59-80.

- GUTTERMAN, Y. (1974). The influence of the photoperiodic regime and far-red light treatments of Portulaca oleracea L. plants on the germinability of their seeds. *Oecologia* 17 pp 27-38.
- GUTTERMAN, Y. (1980-1981). Influences on seed germinability phenotypic material effects during seed maturation. *Isr. J. Bot.* 29 (1-4) pp 105-117.
- GUTTERMAN, Y. and HEYDECKER, W. (1973). Studies of the surfaces of desert plant seeds I. Effect of day length upon maturation of the seed coat of Ononis sicula Guss. *Ann. Bot.* 37 pp 1049-1050.
- GUTTERMAN, Y. and PORATH, D. (1975). Influences of photoperiodism and light treatments during fruit storage on the phytochrome and on the germination of Cucumis prophetarum L. and Cucumis sativus L. seeds. *Oecologia (Berl.)* 18 pp 37-43.
- GWYNN, D. and SCHEIBE, J. (1972). An action spectrum in the blue for inhibition of germination of lettuce seed. *Planta* 106 pp 247-257.
- HAND, D.J., CRAIG, G., TAKAKI, M. and KENDRICK, R.E. (1982). Interaction of light and temperature on seed germination of Rumex obtusifolius. *Planta* 156 pp 457-460.
- HARTMANN, K.M. (1966). A general hypothesis to interpret "high energy phenomena" of photomorphogenesis on the basis of phytochrome. *Photochem. Photobiol.* 5 pp 349-366.
- HAUPT, W. (1972). Localisation of phytochrome within the cell. In : Mitrakos, K. and Shropshire, W. Jr. (Eds.). *Phytochrome*. Academic Press, London. pp 553-569.
- HAUPT, W. and WEISENSEEL, M.H. (1976). Physiological evidence and some thoughts on localised responses, intracellular localisation and action of phytochrome. In : Smith, H. (ed.) *Light and plant development*. Butterworths, London. pp 63-74.

- HAYES, R.G. and KLEIN, W.H. (1974). Spectral quality influence of light during development of Arabidopsis thaliana plants in regulating seed germination. *Plant and Cell Physiol.* 15 pp 643-653.
- HEATHCOTE, L., BAMBRIDGE, K.R., and MCLAREN, J.S. (1979). Specially constructed growth cabinets for simulation of the spectral photon distributions found under natural vegetation canopies. *J. Exp. Bot.* 30 pp 347-353.
- HENDRICKS, S.B. and BORTHWICK, H.A. (1967). The function of phytochrome in regulation of plant growth. *Proc. Natl. Acad. Sci. U.S.A.* 38 pp 2125-2130.
- HENDRICKS, S.B. and TAYLORSON, R.B. (1976). Variation in germination and amino acid leakage of seeds with temperature related to membrane phase change. *Plant Physiol.* 58 pp 7-11.
- HENDRICKS, S.B. and TAYLORSON, R.B. (1978). Dependence of phytochrome action in seeds on membrane organization. *Plant Physiol.* 61 pp 17-19.
- HENDRICKS, S.B. and TAYLORSON, R.B. (1979). Dependence of thermal responses of seeds on membrane transitions. *Proc. Natl. Acad. Sci. U.S.A.* 76 pp 778-781.
- HENDRICKS, S.B. and TAYLORSON, R.B. (1980). Reversal by pressure of seed germination promoted by anaesthetics. *Planta* 149 pp 108-111.
- HENDRICKS, S.B., TOOLE, V.K. and BORTHWICK, H.A. (1968). Opposing actions of light in seed germination of Poa pratensis and Amaranthus arenicola. *Plant Physiol.* 43 pp 2023-2028.
- HEYDECKER, W. (1965). Establishment of seedlings in the field. I. Influence of sowing depth on seedling emergence. *J. Hortic. Sci.* 31 pp 76-88.
- HILTON, J.R. and SMITH, H. (1980). The presence of phytochrome in purified barley etioplasts and its in-vitro regulation of biologically-active gibberellin levels in etioplasts. *Planta* 148 pp 312-318.

- HOLM, R.E. (1972). Volatile metabolites controlling germination in buried weed seeds. *Plant Physiol.* 50 pp 293-297.
- HOLMES, M.G. and SMITH, H. (1977). The function of phytochrome in the natural environment II - the influence of vegetation canopies on the spectral energy distribution of natural daylight. *Photochem. Photobiol.* 25 pp 539-546.
- HSIAO, A.I. and VIDAVER, W. (1970). Seed water content in relation to phytochrome - mediated germination of lettuce seeds (*Lactuca sativa* L. var Grand Rapids). *Can. J. Bot.* 49 pp 111-115.
- HSIAO, A.I. and VIDAVER, W. (1971). Water content and phytochrome-induced potential germination responses in lettuce seeds. *Plant Physiol.* 47 pp 186-188.
- HSIAO, A.I. and VIDAVER, W. (1973). Dark reversion of phytochrome in lettuce seeds stored in a water saturated atmosphere. *Plant Physiol.* 51 pp 459-463.
- HUGHES, J.E., MORGAN, D.C., LAMBTON, P.A., BLACK, C.R. and SMITH, H. (1984) Photoperiodic time signals during twilight. *Plant, Cell and Environment.* 7 pp 269-277.
- HUNT, R.E. and PRATT, L.H. (1980). Partial characterisation of undegraded oat phytochrome. *Biochemistry* 19 pp 390-394.
- IKUMA, H., and THIMANN, K.V. (1964). Analysis of germination processes of lettuce seed by means of temperature and anaerobiosis. *Plant Physiol.* 39 pp 756-767.
- INGRAM, T.J. and BROWNING, G. (1979). Influence of photoperiod on seed development in genetic line of peas G<sub>2</sub> and its relationship to changes in endogenous gibberellins measured by combined gas chromatography and mass spectroscopy. *Planta.* 146 pp 423-432.
- JUNTTLA, O. (1973). Seed and embryo germination in *Syringa vulgaris* and *S. reflexa* as affected by temperature during seed development. *Physiol. Plant.* 29 pp 264-268.

- KAHN, A. (1960). An analysis of "dark osmotic inhibition" of germination of lettuce seeds. *Plant Physiol.* 35 pp 1-7.
- KARSSEN, C.M. (1967). The light promoted germination of the seeds of Chenopodium album. I - the influence of the incubation time on the quantity and rate of the response to red light. *Acta Bot. Neerl.* 16 pp 156-160.
- KARSSEN, C.M. (1970a). The light promoted germination of the seeds of Chenopodium album. III - effect of the photoperiod during growth and development of the plants on the dormancy of the produced seeds. *Acta Bot. Neerl.* 19 pp 81-94
- KARSSEN, C.M. (1970b). The light promoted germination of the seeds of Chenopodium album. IV - Pfr requirements during different stages of the germination process. *Acta Bot. Neerl.* 19 pp 297-312.
- KARSSEN, C.M. (1980-1981). Environmental conditions and endogenous mechanisms involved in secondary dormancy of seeds. *Isr. J. Bot.* 29 (1-4) pp 45-64.
- KENDRICK, R.E. (1976). Photocontrol of seed germination. *Sci. Prog. Oxf.* 63 pp 347-367.
- KENDRICK, R.E. and de Kok, J. (1983). Intermediates in phytochrome phototransformation. *Sci. Prog., Oxf.* 68 pp 475-486.
- KENDRICK, R.E. and SPRUIT, C.J.P. (1973a). Phytochrome properties and the molecular environment. *Plant Physiol.* 52 pp 327-331.
- KENDRICK, R.E. and SPRUIT, C.J.P. (1973b). Phytochrome intermediates in vivo I. Effects of temperature, light intensity and oxygen on intermediate accumulation. *Photochem. Photobiol.* 18 pp 139-144.
- KENDRICK, R.E. and SPRUIT, C.J.P. (1974). Inverse Dark Reversion of Phytochrome : An Explanation. *Planta* 120 pp 265-272.
- KENDRICK, R.E. and SPRUIT, C.J.P. (1977). Phototransformation of phytochrome. *Photochem. Photobiol.* 26 pp 201-214.
- KENDRICK, R.E., SPRUIT, C.J.P., and FRANKLAND, B. (1969). Phytochrome in seeds of Amaranthus caudatus. *Planta* 88 pp 293-307.

- KHAN, A.A. and KARSSSEN, C.M. (1980). Induction of secondary dormancy in Chenopodium bonus-henricus L. seeds by osmotic and high temperature treatments and its prevention by light and growth regulators. *Plant Physiol.* 66 pp 175-181.
- KIGEL, J., OFIR, M. and KOLLER, D. (1977). Control of germination responses of Amaranthus retroflexus L. seeds by their parental photothermal environment. *J. Exp. Bot.* 28 pp 1125-1136.
- KING, T.J. (1975). Inhibition of seed germination under leaf canopies in Avenaria serpyllifolia, Veronica arvensis and Cerastium holosteoides. *New Phytol.* 75 pp 87-90.
- KIVILAAN, A. and BANDURSKI, R.S. (1973). The ninety-year period for Dr. Beal's seed viability experiment. *Am. J. Bot.* 60 pp 140-145.
- KRISTIE, D.N., BASSI, P.K. and SPENCER, M.S. (1981). Factors affecting the induction of secondary dormancy in lettuce Lactuca sativa. *Plant Physiol.* 67 pp 1224-1229.
- LOERCHER, L. (1974). Persistence of red light induction in lettuce seeds varying hydration. *Plant Physiol.* 53 pp 503-506.
- MACDONALD, I.R. and HART, J.W. (1981). An inhibitory effect of light on the germination of mustard seed. *Ann. Bot.* 47 pp 275-277.
- MACKENZIE, J.M., BRIGGS, W.R. and PRATT, L.M. (1978). Phytochrome photoreversibility : empirical test of the hypothesis that it varies as a consequence of pigment compartmentation. *Planta* 141 pp 129-134.
- MALCOSTE, R., TZANNI, H., JACQUES, R. and ROLLIN, P. (1972). The influence of blue light on dark germinating seeds of Nemophila insignis. *Planta* 103 pp 24-34.
- MANCINELLI, A.L. (1980). The photoreceptors of the high irradiance response of plant photomorphogenesis. *Photochem. Photobiol.* 32 pp 853-857.
- MANCINELLI, A.L. and BORTHWICK, H.A. (1964). Photocontrol of germination and phytochrome reaction in dark germinating seeds of Lactuca sativa L. *Ann. Bot. (Rome)* 28 pp 9-24.

- MANDOLLI, D.F. and BRIGGS, W.R. (1981). Phytochrome control of two low-irradiance responses in etiolated oat seedlings. *Plant Physiol.* 67 pp 733-739.
- MARBACH, I. and MAYER, A.M. (1974). Permeability of seed coats to water as related to drying conditions and metabolism of phenolics. *Plant Physiol.* 54 pp 817-820.
- MARME, D., BOISARD, J. and BRIGGS, W.R. (1973). Binding properties in vitro of phytochrome to a membrane fraction. *Proc. Natl. Acad. Sci. U.S.A.* 70 pp 3861-3865.
- MCCULLOUGH, J.M. and SHROPSHIRE, W. (Jr.) (1970). Physiological predetermination of germination responses in *Arabidopsis thaliana* (L) Heynh. *Plant and Cell Physiol.* 11 pp 139-148.
- MORGAN, S.R. and BERRIE, A.M.M. (1970). Development of dormancy during seed maturation in *Avena ludoviciana*, winter wild oat. *Nature* 228 p 1225.
- NABORS, M.W. and LANG, A. (1971a). The growth physics and water relations of red-light-induced germination in lettuce seeds (I). Embryos germinating in osmoticum. *Planta* 101 pp 1-25.
- NABORS, M.W., and LANG, A. (1971b). The growth physics and water relations of red-light-induced germination in lettuce seeds (II). Embryos germinating in water. *Planta* 101 pp 26-42.
- NABORS, M.W., KUGRENS, P. and ROSS, C. (1974). Photodormant lettuce seeds : phytochrome induced protein and lipid degradation. *Planta* 117 pp 361-365.
- NEGBI, M., BLACK, M., and BEWLEY, J.D. (1968). Far-red sensitive dark processes essential for light- and gibberellin-induced germination of lettuce seeds. *Plant Physiol.* 43 pp 35-40.
- NEGBI, M. and KOLLER, D. (1964). Dual action of white light in the photocontrol of germination of *Oryzopsis miliacea*. *Plant Physiol.* 39 pp 247-253.

- PECKET, R.C. and AL-CHARCHAFCHI, F. (1979). The photocontrol of respiration in light sensitive lettuce seeds. *J. Exp. Bot.* 30 pp 839-842.
- PONS, T.L. (1983). Significance of inhibition of seed germination under the leaf canopy in ash coppice. *Plant, Cell and Environment* 6 pp 385-392.
- POURRAT, Y. and JACQUES, R. (1975). The influence of photoperiodic conditions received by the mother plant on morphological and physiological characteristics of Chenopodium polyspermum L. seeds. *Plant Science Letters* 4 pp 273-279.
- QUAIL, P.H. and BRIGGS, W.R. (1978). Irradiation-enhanced phytochrome pelletability : requirement for phosphorylative energy in vivo. *Plant Physiol.* 62 pp 773-778.
- QUAIL, P.H. and GRESSEL, J. (1976). Particle-bound phytochrome : interaction of the pigment with ribonucleoprotein material from Cucurbita pepo L. In : Smith, H. (ed.) *Light and Plant Development*. Butterworth, London, pp 111-128.
- QUAIL, P.H., MARMÉ, D. and SCHÄFER, E. (1973). Particle-bound phytochrome from maize and pumpkin. *Nature - New Biology* 245 pp 189-191.
- RACUSEN, R.H. (1976). Phytochrome control of electrical potentials and intercellular coupling in oat-coleoptile tissue. *Planta* 132 pp 25-29.
- RETHY, R., DEPONDER, A., FREDERICQ, H. and DE GREEF, J. (1983). Factors affecting the induction and release of secondary dormancy in Kalanchoë seeds. *Plant, Cell and Environment* 6 pp 731-738.
- RICHARDSON, S.G. (1979). Factors influencing the development of primary dormancy in wild oat, Avena fatua, seeds. *Can. J. Plant Sci.* 59 pp 777-784.
- ROBERTS, H.A. and LOCKETT, P.M. (1978). Seed dormancy and periodicity of seedling emergence in Veronica hederifolia L. *Weed Research* 18 pp 41-48.

SCHÄFER, E., FUKSHANSKY, L., and SHROPSHIRE, Jr., W. (1983). Action Spectroscopy of Photoreversible Pigment Systems. In Encyclopaedia of Plant Physiology 16A pp 39-68. Ed. W. Shropshire and H. Mohr.

- ROLLIN, P., MALCOSTE, R., and EUDE, D. (1970). Le role du phytochrome dans la germination des graines de Nemophila insignis L. Planta 91 pp 227-234.
- ROTH-BEJERANO, H., KOLLER, D. and NEGBI, M. (1966). Mediation of phytochrome in the inductive action of low temperature on dark germination of lettuce seed at supro-optimal temperatures. Plant Physiol. 41 pp 962-964.
- ROUX, S.J., McENTIRE, K., SLOCUM, R.D., CEDEL, T.E. and HALE, C.C. (1981). Phytochrome induces photoreversible calcium fluxes in purified mitochondrial fractions from oats. Proc. Natl. Acad. Sci. U.S.A. 78 pp 283-287.
- SAUER, J. and STRUIK, G. (1964). A possible ecological relation between soil disturbance, light flash and seed germination. Ecology 45 pp 884-886.
- SCHEIBE, J. and LANG, A. (1969). Lettuce seed germination : effects of light temperature and of repeated far-red treatment in relation to phytochrome. Photochem. Photobiol. 9 pp 143-150.
- SCHULZ, M.R. and KLEIN, R.M. (1963). Effects of visible and ultra violet radiation on the germination of Phacelia tanacetifolia. Amer. J. Bot. 50 pp 430-434.
- SHROPSHIRE, W. Jr. (1973). Photoinduced parental control of seed germination and the spectral quality of solar radiation. Solar Energy 15 pp 99-105.
- SILVERTOWN, J. (1980). Leaf-canopy-induced seed dormancy in a grassland flora. New Phytol. 85 pp 109-118.
- SIMMONDS, J.A., and SIMPSON, G.M. (1971). Increased participation of pentose phosphate pathway in response to after ripening and gibberellic acid treatment in caryopses of Avena fatua. Can. J. Bot. 49 pp 1833-1840.
- SMALL, J.G.C., SPRUIT, C.J.P., BLAAUW-JANSEN, G. and BLAAUW, O.H. (1979a) Action spectra for light induced germination in dormant lettuce seeds (I) red region. Planta 144 pp 125-132.

- SMALL, J.G.C., SPRUIT, C.J.P., BLAAUW-JANSEN, G. and BLAAUW, O.H. (1979b). Action spectra for light germination in dormant lettuce seeds (II) blue region. *Planta* 144 pp 133-136.
- SMITH, H. (1973). Light quality and germination : ecological implications. In Heydecker, W. (ed.) *Seed Ecology*. Butterworth, London. pp 219-231.
- SMITH, H. (1975). *Phytochrome and Photomorphogenesis*. McGraw-Hill, London.
- SMITH, H. (1982). Light quality, photoperception, and plant strategy. *Ann. Rev. Plant Physiol.* 33 pp 481-518.
- SMITH, H. and HOLMES, M.G. (1977). The function of phytochrome in the natural environment III. Measurement and calculation of phytochrome photoequilibrium. *Photochem. Photobiol.* 25 pp 547-550.
- SPRUIT, C.J.P. (1980). Short term far-red reversibility of red potentiated chlorophyll accumulation in beens. In : De Greef, J.A. (ed.) *Photoreceptors and plant development*. Antwerpen University Press, Antwerpen, pp 179-183.
- SPRUIT, C.J.P. and MANCINELLI, A.L. (1969). Phytochrome in cucumber seeds. *Planta* 88 pp 303-310.
- STOUTJESDIJK, P.H. (1972). Spectral transmission curves of some types of leaf canopies with a note on seed germination. *Acta Bot. Neerl.* 21 pp 185-191
- TAKAKI, M., KENDRICK, R.E. and DIETRICH, S.M.C. (1981). Interaction of light and temperature on the germination of Rumex obtusifolius L. *Planta* 152 pp 209-214.
- TAKEBA, G. (1980). Phytochrome mediated accumulation of free amino-acids in embryonic axes of lettuce, Lactuca sativa cultivar New-York-515-Improved seeds. *Plant Cell Physiol.* 21 pp 1651-1656.
- TANADA, T. (1968). Substances essential for a red, far-red light reversal of attachment of mung bean root tips to glass. *Plant Physiol.* 43 pp 2070-2071.

- TAYLORSON, R.B. (1972). Phytochrome controlled changes in dormancy and germination of buried weed seeds. *Weed Science* 20 pp 417-422.
- TAYLORSON, R.B. (1984). Prevention of action of far-red absorbing phytochrome in Rumex crispus L. seeds by ethanol. *Plant Physiol.* 74 pp 223-226.
- TAYLORSON, R.B. and HENDRICKS, S.B. (1969). Action of phytochrome during pre-chilling of Amaranthus retroflexus L. seeds. *Plant Physiol.* 44 pp 821-825.
- TAYLORSON, R.B. and HENDRICKS, S.B. (1972a). Interactions of light and a temperature shift on seed germination. *Plant Physiol.* 49 pp 127-130.
- TAYLORSON, R.B. and HENDRICKS, S.B. (1972b). Rehydration of phytochrome in imbibing seeds of Amaranthus retroflexus L. *Plant Physiol.* 49 pp 663-665.
- TAYLORSON, R.B. and HENDRICKS, S.B. (1972c). Phytochrome control of germination of Rumex crispus L. seeds induced by temperature shifts. *Plant Physiol.* 50 pp 645-648.
- TAYLORSON, R.B. and HENDRICKS, S.B. (1973). Phytochrome transformation and action in seeds of Rumex crispus L. during secondary dormancy. *Plant Physiol.* 52 pp 475-479.
- TAYLORSON, R.B. and HENDRICKS, S.B. (1979). Overcoming dormancy in seeds with ethanol and other anaesthetics. *Planta* 145 pp 507-510.
- THOMPSON, K., GRIME, J.P. and MASON, G. (1977). Seed germination in response to diurnal fluctuations in temperature. *Nature* 267 pp 147-149.
- TOTTERDELL, S. and ROBERTS, E.H. (1979). Effects of low temperature on the loss of innate dormancy and the development of induced dormancy in seeds of Rumex obtusifolius L. and Rumex crispus L. *Plant, Cell and Environment* 2 pp 131-137.
- VAN DER HOEF, L.N., QUAIL, P.H. and BRIGGS, W.R. (1979). Red light-inhibited mesocotyl elongation in maize seedlings. II. Kinetic and spectral studies. *Plant Physiol.* 63 pp 1062-1067.

- VAN DER MEIJDEN, E. and VAN DER WAAIS-KOOI, R.E. (1979). The population ecology of Senecio jacobaea in a sand-dune system. *J. Ecol.* 67 pp 131-153.
- VAN DER VEEN, R. (1970). The importance of the red-far red antagonism in photoblastic seeds. *Acta Bot. Neerl.* 19 pp 809-812.
- VAN DER WOUDE, W.J. (1983). Mechanisms of photo-thermal interactions in phytochrome control of seed germination. In : Meudt, W.J. (ed.) *Beltsville Symposia in Agricultural Research, vol. 6. Strategies of Plant Reproduction*, Allanheld, Osmun & Co., Totowa, New Jersey, U.S.A.
- VAN DER WOUDE, W.J. and TOOLE, V.K. (1980). Studies of the mechanism of enhancement of phytochrome dependent lettuce (Lactuca sativa cv. Grand Rapids) seed germination by pre-chilling. *Plant Physiol.* 66 pp 220-224.
- VAZQUEZ-YANES, C. (1980). Light quality and seed germination in Cecropia obtusifolia and Piper auritum from a tropical rain forest in Mexico. *Phyton Rev. Int. Bot. Res.* 38 pp 33-36.
- VEGIS, A. (1964). Dormancy in higher plants. *Ann. Rev. Pl. Physiol.* 15 pp 185-224.
- VIDAVER, W. and HSIAO, A.I. (1974). Actions of gibberellic acid and phytochrome on the germination of Grand Rapids lettuce seeds. *Plant Physiol.* 53 pp 266-268.
- VIDAVER, W., and HSIAO, A.L. (1975). Secondary dormancy in light-sensitive lettuce seeds incubated anaerobically or at elevated temperature. *Can. J. Bot.* 53 pp 2557-2564.
- WATSON, P.J. and SMITH, H. (1982). Integral association of phytochrome with a membranous fraction from etiolated Avena shoots : In vivo characterisation and physiological significance. *Planta* 154 pp 128-134.
- WESSON, G. and WAREING, P.F. (1969a). The role of light in the naturally occurring populations of buried seeds. *J. Exp. Bot.* 20 pp 402-413.
- WESSON, G. and WAREING, P.F. (1969b). The induction of light sensitivity in weed seeds by burial. *J. Exp. Bot.* 20 pp 414-425.

WHITELAM, G.C., NAPIER, R.M. and SMITH, H. (1984). Phytochrome and membranes. In : Boudet, A.M., Alibert, G., Marigo, G. and Lea, P.J. (Eds.) Annual Proceedings of the Phytochemical Society of Europe 24 pp 127-145.

WOOLLEY, J.T. and STOLLER, E.W. (1978). Light penetration and light induced germination in soil. Plant Physiol. 61 pp 597-600.

WURZBURGER, J. and KOLLER, D. (1976). Differential effects of the parental photothermal environment on development of dormancy in caryopses of Aegilops kolschyi. J. Exp. Bot. 27 pp 43-48.

## ABSTRACT.

A study of photoinhibition of seed germination and the induction of secondary dormancy has been made on weedy species which tend to produce large numbers of small, light sensitive seeds.

Both light-requiring (e.g., *Chenopodium album*) and light-inhibited (e.g., *Amaranthus caudatus*) species were used but nevertheless were found to show similar responses to high fluence irradiation, differences being largely ones of varying sensitivity.

All species tested (except *Digitalis purpurea*) showed a marked inhibition of germination in continuous fluorescent white light supplemented with far-red compared to the response to fluorescent white light only.

*Urtica urens* and *A. caudatus* germination, however, could be inhibited by fluorescent white light only and this response was dependent on both time and fluence rate. Interestingly, *A. caudatus* is a dark germinator whereas *U. urens* is light requiring (i.e., a small amount of light promotes germination but a large amount is inhibitory). The inhibitory action of prolonged light is dependent on photon fluence rate. In photoinhibition mediated through phytochrome cycling rate of the pigment appears to be important. However, cycling rate per se cannot explain all the observed responses; and the interruption of dark processes is another important factor. Cycling rate effects are increased when photoequilibrium is low. There is also a blue light photoreceptor of unknown form which shows fluence dependent characteristics in its photoinhibitory activity.

Secondary dormancy is induced in seeds which have the ability to germinate but are prevented from doing so. In respect of the light environment, the same light conditions which inhibit germination also tend to induce secondary dormancy although there is no direct evidence on the action of blue light operating through the blue photoreceptor.

The depth of secondary dormancy increases with the time of incubation in the inhibitory conditions and also becomes deeper under low photoequilibrium and high photon fluence rate. High photon fluence rate fluorescent white light inhibits the germination of *U. urens* but the high photoequilibrium established allows the seed to germinate in subsequent darkness.

Photoinhibition of germination and induction of secondary dormancy have adaptive advantages for survival of the species since seedlings can avoid the competitive stresses of a stand of vegetation and the desiccating environment of the soil surface in full sunlight. Photoinhibition appears to act by preventing the active processes of germination from occurring, which thus enables the seeds to pass through cycles of hydration and dehydration without being damaged.