

# Evaluation of Thermal Comfort in Naturally Ventilated School Classrooms during the heating season using CFD

Charalampos Angelopoulos\*<sup>1</sup>, Malcolm J. Cook<sup>1</sup>, Christopher R. Iddon<sup>2</sup> and Stephen M. Porritt<sup>1</sup>

<sup>1</sup>Loughborough University, School of Civil and Building Engineering, LE11 3TU, UK

<sup>2</sup>SE Controls, Hood Innovation Centre, Wellington Crescent, Lichfield, WS13 8RZ, UK.

\*c.angelopoulos@lboro.ac.uk

## Abstract

This paper investigates the performance and control of natural ventilation during the heating season in order to avoid occupant discomfort. The current study examined different window configurations under a wide range of external temperatures and wind speeds using a CFD simulation tool. The results showed that thermally comfortable indoor conditions could be achieved in a UK classroom when external temperatures are as low as 8°C using high-level openable windows. At lower external temperatures, occupants are predicted to be thermally dissatisfied due to localised discomfort caused by draughts. The results from the CFD model also suggest that acceptable internal thermal conditions can be maintained with wind speeds up to 10m/s, for an external temperature of 10°C. The PMV results indicated that thermal comfort is achieved and is uniformly distributed within the classroom. This work will enable the UK's Education Funding Agency to have a greater understanding of the effective control of windows to eliminate wintertime discomfort and avoid unnecessary heating for naturally ventilated spaces.

## Introduction

Natural ventilation is considered a sustainable solution to maintain healthy and thermally comfortable internal environments and offers lower energy consumption compared to mechanical ventilated spaces (Ji, Lomas, & Cook, 2009). However, the flows that are created in naturally ventilated spaces are more complex compared to mechanical systems and hence more difficult to predict. Thus, a natural ventilation strategy should be carefully designed, and the physics understood. This is even more crucial during wintertime, because cold draughts could cause discomfort conditions for the occupants (Fanger, 1977). This effect is even more important when it comes to environments that require specific conditions, such as schools.

Thermal comfort and indoor air quality are fields that have attracted attention with respect to school environments. Limited studies have investigated the internal thermal conditions and the level of indoor air quality in schools is associated with pupils' performance. Low ventilation rates in classrooms have been shown to negatively affect students' performance regarding attention, memory and concentration (Coley et al., 2007; Bakó-Biró, et al., 2012; Barrett, et al., 2015). In

addition, previous studies have indicated that students could possibly suffer from long-lasting health issues, such as asthma, when they are exposed to environments where ventilation rates are below the recommended values (Mendell & Heath, 2005).

Previous researches have examined the levels of thermal comfort and indoor air quality in naturally ventilated English school classrooms. Although internal temperatures during the heating season were found to be acceptable, the monitored data revealed poor indoor air quality in some of the classrooms, mainly due to inadequate control of the windows (Iddon & Hudleston, 2014; Chatzidiakou, et al., 2015). Due to low external air temperatures, the teachers preferred to keep the windows closed to avoid thermal discomfort conditions in the classroom, which resulted in very low ventilation rates. Hence, it is essential to effectively control the opening of the windows in naturally ventilated classrooms to provide adequate outside air and to secure the absence of cold draughts.

In England, the Priority School Building Program Facilities Output Specification (PSBP-FOS) requires natural ventilation solutions to meet a performance specification to ensure occupant comfort and reduce discomfort from draughts (PSBP, 2014). The draft BB101 Guidelines on ventilation, thermal comfort and indoor air quality in schools, which is currently out for consultation, contains further guidance on acceptable internal conditions when ventilating a classroom naturally. This includes internal air temperature and airspeed within the occupied zone to avoid cold draughts (PSBP, 2014; EFA, 2016). However, there is a lack of research that investigates under what conditions these requirements can be met. The aim of this current study is to bridge the gap in the literature on the effective control of natural ventilated systems under several outside conditions during wintertime.

## Methodology

To discern the most appropriate conditions for natural ventilation in classrooms during the heating period, the performance of different ventilation scenarios was explored. These scenarios include single-sided natural ventilation of a classroom using two opening configurations during a range of weather conditions.

The present study examined the performance of single-sided natural ventilation systems in a typical UK classroom that is 7.8m long, 9m wide and 3.3m high

using a Computational Fluid Dynamics (CFD) simulation tool. The dimensions of the classroom are in agreement with the rule of thumb proposed by CIBSE (2005a), stating that the depth of the classroom should not exceed 2.5 times the height of the space when a single sided ventilation strategy, with high and low ventilation openings, is used. The classroom contained thirty students and two additional occupants who were considered to be the teacher and the teaching assistant. The occupants were equally distributed across the classroom in such a way that a circulation area on the perimeter of the classroom was available, see Figure 1. In total four windows were modelled and based on the examined ventilation strategy the windows were modelled as top-hung open-out or bottom-hung open-in. The high-level openings were 2.6m wide, 0.7m high, and the low-level 2.6m wide and 1.4m high. The opening angle of the windows, and hence the free area of the windows, varied according to the outside conditions in order to ensure that the provision of outside air was about 8 l/s/p, which is the preferred ventilation flow rate for classrooms.

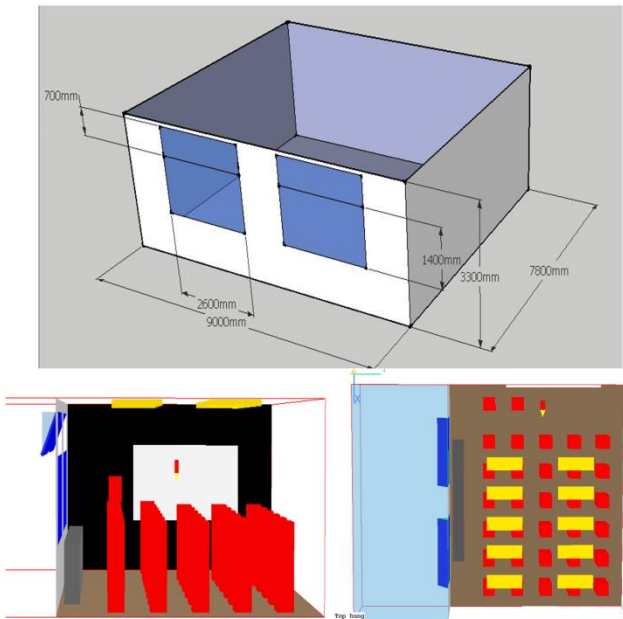

Figure 1: Benchmark geometry for CFD simulations. Plan view (top) and vertical section (bottom) of the classroom. Occupants are represented in red; ceiling lights are shown in yellow and furniture in grey.

For the base case scenarios, the top-level windows were modelled to be open. However, for outside conditions with air temperatures above a certain limit, both the low and high-level windows were modelled to be open to ensure additional airflow to prevent overheating. The low-level windows were assumed to open manually and they were restricted to 100mm opening length. This configuration is widely used for safety purposes. In the initial design of the classroom, similar geometry was used but without the use of furniture. However, after launching the simulations with several outside conditions it was observed that although the ventilation rate and the average internal air temperature were within

the recommended values from EFA (2016), almost 26% [8 out of 30] of the students will most likely experience discomfort conditions due to cold draughts. Thus, an item of furniture (4.8m, 0.485m, 1.2m) was placed directly below the window and 150mm away from the wall. This unit can be used as a storage facility or as bookshelves. The furniture was used to divert the cold air from entering into the occupied zone directly.

Table 1 shows the boundary conditions for the CFD simulations. The values for the heat gains for the ceiling lights were adapted from BB101 (EFA, 2016). For the occupants, BB101 proposes 70W per occupant for the heat gains. However, a more sophisticated approach was used to simulate the heat gains for this study, whereby the convective portion of the occupant heat gain is modelled as a constant heat flux at the location of the occupants and the radiant component is assumed to be absorbed and be emitted by the walls. To accurately calculate the convective portion of heat gains, the values from CIBSE (2015) have been used for the percentage of the radiant portion.

Table 1: Boundary conditions for the CFD simulations.

| Object          | Dimensions (X,Y,Z)(m,m,m)      | Heat output             | Quantity |
|-----------------|--------------------------------|-------------------------|----------|
| Occupants       | (0.5,0.5,1.4)                  | 39.6 [W]                | 32       |
| Classroom walls | -                              | 6.5 [W/m <sup>2</sup> ] | 4        |
| Ceiling         | (9,7.8,-)                      | 6.5 [W/m <sup>2</sup> ] | 1        |
| Floor           | (9,7.8,-)                      | 0                       | 1        |
| Lights          | (0.4,1.5,0.1)                  | 70 [W per unit]         | 10       |
| Computer        | (0.2,0.5,0.3)                  | 100 [W]                 | 1        |
| Interactive     |                                | 100 [W]                 | 1        |
| Furniture       | (4.8,0.485,1.2)                | -                       | 1        |
| Window          | Based on the examined scenario | -                       | 2 or 4   |

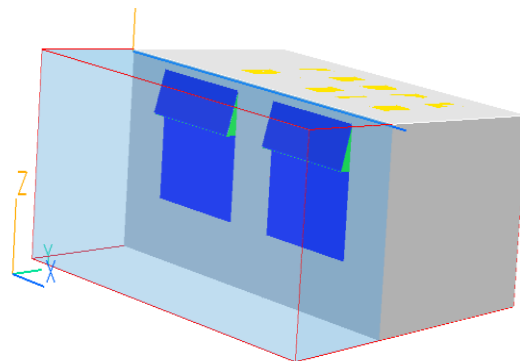

Figure 2: The light blue walls represent the boundary conditions for the domain.

Rather than specify boundary conditions directly at the opening windows, an exterior domain was used to represent the ambient air. On the low-X, high-X, on the

low-Y and high-Y and on the high-Z boundaries of the domain, (see Figure 2), the orifice flow equation was used with a discharge coefficient of  $C_d = 0.61$  [-] (Equation 1). This enabled the air to flow into and out of the domain (and the classroom) according to the prevailing pressure differences and aids convergence stability.

$$\text{Pressure drop} = \frac{1}{C_d^2} = \frac{1}{0.61^2} = 2.69 \quad (1)$$

For the wind driven natural ventilation cases, a "WIND-PROFILE" object was imposed using a logarithmic wind profile. A 2D inlet boundary condition associated with the wind velocity profile was used (CHAM, 2016). Furthermore, the wind direction was selected to be normal to the low-Y face and thus the input value was given only to the Y-direction component of the velocity. In addition, it was assumed that the wind velocity profile was fully developed at the height of the building and hence the reference height was set to be 3.3 m. For both the buoyancy and the wind-driven cases, the whole domain approach was used whereby the internal and external environments are modelled simultaneously, allowing prediction of the airflow and temperature around the classroom, at the ventilation openings as well as throughout the interior spaces (Spentzou, 2015). For the buoyancy case the size of the domain was  $[X,Y,Z]=[9\text{m},11.8\text{m},3.3\text{m}]$  and for the wind case  $[X,Y,Z]=[50\text{m},70\text{m},16.5\text{m}]$ .

### Ventilation Strategies

For the purpose of this research, the scenarios focus on both wind and buoyancy driven natural ventilation scenarios. For both cases, the scenarios include a broad range of external conditions. In total eleven scenarios were examined which are shown in the table below:

Table 2: Ventilation scenarios

| Buoyancy Driven Ventilation Scenarios |                                    |  | Wind Driven Ventilation Scenarios                    |
|---------------------------------------|------------------------------------|--|--|
| Top hung-out high level openings      | Bottom hung-in high level openings | Top hung-out high and low level openings | Bottom hung-in high level openings and 10 °C outside |
| 8°C outside                           | 8°C outside                        | 15°C outside                             | 3.5m/s wind speed                                    |
| 10°C outside                          | 10°C outside                       |  | 5m/s wind speed                                      |
| 13°C outside                          | 13°C outside                       |  | 7m/s wind speed                                      |
|                                       |                                    |  | 10m/s wind speed                                     |

### Evaluation Criteria

To assess the performance of the different ventilation scenarios the predicted internal air temperature and velocity as well as the provision of the outside air are examined for buoyancy and wind-driven scenarios. The CFD simulations provide predictions of the air

temperature and velocity across the classroom with visual representation of their patterns. These results are used to evaluate the variance in the classroom's air temperature and velocity at different heights. All the values are examined in the occupied zone, considered to be between 0.6m and 1.4m above floor level and at ankle height, 0.1m above the floor (EFA, 2016).

Based on the criteria established by BB101 for natural ventilation during the heating season, the air temperature difference between the incoming air and minimum maintained internal temperature, considered to be 19°C, should not exceed 4K. In addition, the difference between the temperature at the ankle and head level should not be greater than 3K (EFA, 2016). Hence, those two criteria are used to evaluate the predicted internal air temperature.

Air velocity and air speed gradients in the classroom are assessed using the metrics in the draft BB101 to examine the risk of cold draughts in the occupied zone. The air speed inside an occupied zone for naturally ventilated spaces should not exceed 0.3m/s providing that there is local control of the vent (EFA, 2016). However, CIBSE:KS6 (2006) states that the ankle and head are the most sensitive parts of the human body to cold draughts, hence the air velocity at 0.1m above the floor, considered to be the ankle height, is also assessed.

Furthermore, predictions of the ventilation rate are essential to evaluate the general indoor air quality of the classroom. The optimum ventilation rate for naturally ventilated classrooms is 8l/s/p (EFA, 2016). If the ventilation rate is close to this value then it is considered that the CO<sub>2</sub> concentration will be below 1000ppm (EFA, 2016). However, for external temperatures above 15°C the ventilation rate should be higher to offset the internal heat gains and prevent any risk of overheating. Table 3 summarizes the evaluation criteria. To calculate the flow field in the openings, additional lines of code were added in the existing CFD code. The objects that were used are 2D planes that can be attached to any object without interfering with the computation or the flow distribution CHAM (2016). The new code was developed explicitly for the purpose of this research. The additional code at each object calculated the average velocity, the volumetric flow rate and the mass flow rate (Spentzou, 2015). Finally, to capture the predicted thermal sensation of the occupants, the CFD simulations calculated the Predicted Mean Vote (PMV). The distribution of the PMV was assessed against the proposed values from BB101.

The behaviour of the downwards plume of incoming air from the open window was assessed by predicting the rate at which the surrounding air was entrained into the plume due to the downwards momentum, i.e. the rate of growth of the plume. This growth is what provides the mixing of the incoming air with the air inside the classroom, which tempers the incoming air. This rate of mixing is determined by the entrainment coefficient, which is calculated by plotting the variation of plume width with height above the source (Cook and Lomas 1998). Fundamental plume theory was used in Cook

(1998) to show that the gradient of this graph is directly proportional to the plume entrainment.

Table 3: Evaluation Criteria (adapted by BB101).

|  |          |
|--|----------|
| Draught air speed [m/s]  | 0.3      |
| $\Delta T$<br>(Min maintained operative temp - plume local air temp) [K] | 4        |
| $\Delta T$<br>(head to ankle) [K]  | 3        |
| PMV  | -1 to +1 |

### CFD simulation tool

The 2016 version of the CFD software PHOENICS (CHAM, 2016), using the FLAIR interface, was used to carry out steady state simulations. This is a well-established tool for simulating and analysing fluid flow, air velocity and temperature by quantitatively predicting the airflow patterns (Walker, 2005). PHOENICS has been widely used by researchers to examine the airflow in classrooms (Chiang and Lai, 2009; Stevanovic et al., 2015; Spentzou et al., 2016). CFD software predicts airflow by solving the conservation equations for mass, momentum and energy. Generally, the airflow is turbulent and hence a method of modelling turbulence is required. This research used the standard k- $\epsilon$  turbulence model of Launder & Spalding (1974) with the Boussinesq approximation for representing buoyancy effects. These models consider the effects of density variations by using an additional source term in the

momentum equation (Cook M. J., 1998) and has been widely tested and used as the main turbulence model for steady state modelling of buoyancy-driven flows (Dascalaki et al., 1999; Visagavel and Srinivasan, 2009). The simulations were considered converged when the spot values of each variable became constant and the enthalpy residual was less than 1% of the total heat gain for the domain. (Cheung, 2011). In general, all residuals were expected to reduce by a factor of 100 from their initial sweeps (Walker, 2005). Prior to launching the simulations for the proposed ventilation scenarios, mesh sensitivity analyses were performed to evaluate the optimum mesh density. For each case the convergence of the simulation and the computational time were evaluated. The optimum number of cells was found to be: [X,Y,Z]=[103,109,38] for the buoyancy cases and [X,Y,Z]=[128,114,49] for the wind cases. For all the examined scenarios, the simulations had reached convergence.

### Results and Analysis

The results from the CFD simulations are presented in this section. Table 4 compares the predicted provision of outside air as well as the average internal air temperature and velocity at different heights for the buoyancy-driven natural ventilation scenarios. The results showed that for

Table 4: Predicted indoor air conditions using CFD for buoyancy driven natural ventilation scenarios.

|   | Top hung-out high level openings |      |      | Bottom hung-in high level openings |      |      | Top hung-out high and low level openings |
|---|----------------------------------|------|------|------------------------------------|------|------|--|
|   | 8                                | 10   | 13   | 8                                  | 10   | 13   |  |
| Outside temperature[°C]                       | 8                                | 10   | 13   | 8                                  | 10   | 13   | 15                                       |
| Ventilation rates[l/s/p]                      | 8.7                              | 8.8  | 8.9  | 8.3                                | 8.3  | 8.5  | 10.6                                     |
| Stroke length [mm]                            | 475                              | 500  | 500  | 475                                | 500  | 500  | 300(top)/100(bottom)                     |
| $\Delta T_{\text{ankle-head}}$ [K]            | 1.40                             | 1.69 | 1.68 | 1.44                               | 1.83 | 1.52 | 1.46                                     |
| $V_{\text{average}}$ [m/s] (0.1m above floor) | 0.21                             | 0.18 | 0.19 | 0.18                               | 0.19 | 0.19 | 0.22                                     |
| $V_{\text{average}}$ [m/s] (0.6m above floor) | 0.08                             | 0.07 | 0.05 | 0.08                               | 0.09 | 0.09 | 0.08                                     |
| $V_{\text{average}}$ [m/s] (1.4m above floor) | 0.07                             | 0.06 | 0.06 | 0.06                               | 0.07 | 0.07 | 0.05                                     |

all the examined scenarios the ventilation flow rates were above the optimum level of 8l/s/p. This suggests that with a controlled opening of the windows it is feasible to maintain acceptable levels of outside air supply for single-sided naturally ventilated spaces. The predicted values of the ventilation flow rates between the top hung-out and bottom-hung-in window configurations are generally close. The CFD predicted slightly higher ventilation rates for the top hung openings.

A possible explanation is that for the top-hung cases the outside air entered through the low part of the window where the free area of the window was greater. In contrast, for the bottom-hung cases, the air entered through the side triangles of the free area of the windows, which are generally smaller in area. The free area is as defined in Jones et al., (2016) as the geometric area of the openings. Nevertheless, based on results from previous studies when the provision of outside air is

above 8l/s/p then the CO<sub>2</sub> concentration is below the recommended value of 1000ppm (EFA, 2016).

Figure 3 & Figure 5 highlight the airflow velocities and the draught plume for the top hung-out and bottom hung-in window configurations for the buoyancy driven natural ventilation scenarios respectively. The contour plots represent a section of the classroom and a plan view of the velocity distribution at the seated height, 0.6m above the floor as it is the lower limit of the occupied zone specified by BB101.

As presented in these graphs, the velocity exceeded the value of 0.3m/s closer to the window and behind the furniture. The placement of the furniture was essential to reduce the risk of cold draughts within the occupied zone. In results not shown, the omission of this furniture resulted in draught plumes that exceeded 0.3m/s in the occupied zone. For all the cases, the velocity patterns indicated the flow paths of the incoming outside air. For

the top hung-out cases, the air entered through the low side of the openings and after passing behind the furniture, it was spread towards the sidewalls.

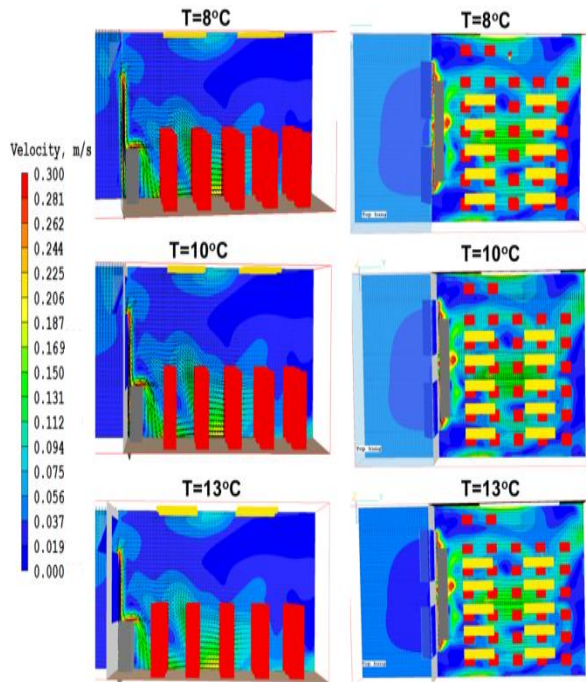

Figure 3: Vertical sections (left) and plan view at 0.6m above floor (right) velocity fields for top hung out buoyancy driven strategies. Contour legend refers to all the graphs and “T” indicates the external temperature.

A graph of plume width ( $b_T$ ) vs vertical distance from the centre of the open window (Figure 4) shows the linear relationship as expected in Gaussian plumes (Cook, 1998). Based on the plume theory in Cook (1998), the gradient of this graph is equivalent to  $\alpha$ , where  $\alpha$  is the rate of growth (or entrainment) into the plume. For the simulations studied here, this leads to an entrainment of  $\alpha_{k-\epsilon}=0.1$  as shown in Figure 4. Furthermore, for the same case, the RNG k- $\epsilon$  turbulence model of Yakhot, et al. (1992) was used and resulted in a slightly decreased entrainment coefficient,  $\alpha_{RNG\ k-\epsilon}=0.09$ .

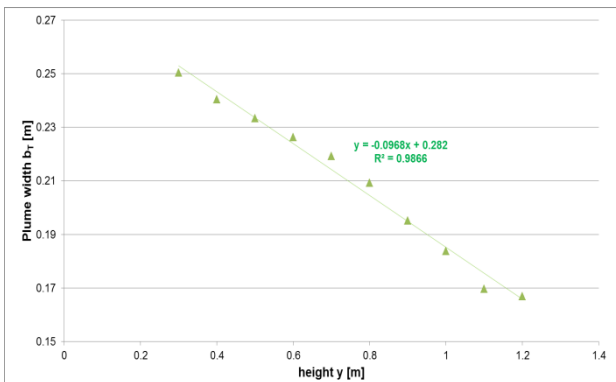

Figure 4: Variation of plume width with distance from the centre of the open window for external temperature of 8°C.

For the bottom hung-in window configuration (Figure 5) the air entered through the sides of the free area of the windows and was circulated towards the middle of the classroom. For all the cases examined, the predicted air velocities within the occupied zone were below the recommended value of 0.3m/s. However, the analysis revealed that it is possible for the occupants sitting closer to the windows to experience air velocities at the ankle height above the proposed limit.

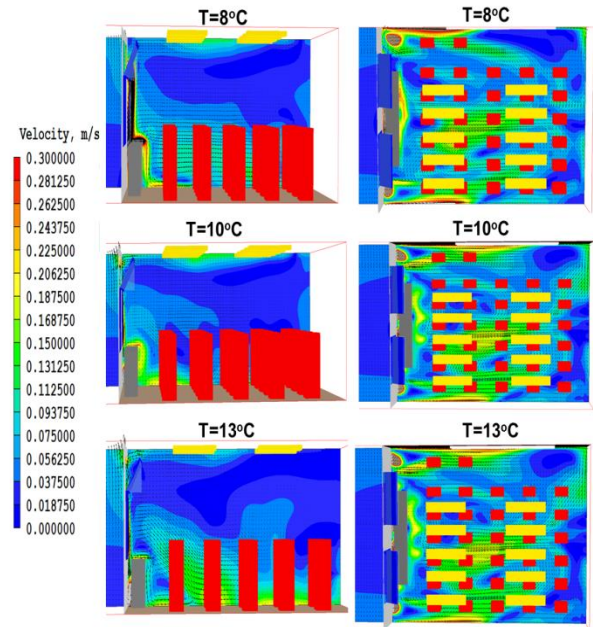

Figure 5: Vertical sections (left) and plan view at 0.6m above floor (right) velocity fields for the bottom hung in buoyancy driven strategies.

Table 4 shows that the temperature differences between the ankle and head height for all the scenarios were within the 3K temperature gradient. As presented in Figure 6 the outside cooler air was sufficiently mixed with the warmer internal air before it reached the occupied zone. The placement of the furniture forced the air to travel for a longer period inside the classroom and this eliminated the risk of cold air at the occupied zone. The window configuration had a small impact on the development of the temperature field. The CFD analysis predicted higher air temperatures for the bottom hung-in cases within the occupied zone. For this configuration, the cold air entered at the top of the classroom where the air was generally warmer. The incoming air stayed at the ceiling level for a longer period and it was mixed with the warmer air before it dropped in the occupied zone. This phenomenon is also known as Coanda effect. Therefore, when it reached the occupied zone it was well mixed with the warmer air of the classroom and this resulted in higher temperatures.

The temperature fields were relatively uniform within the occupied zone with no great variations in the predicted air temperature values. The analysis showed that for top hung-out scenarios there is a cold draught plume close to the floor level, which might result in discomfort at ankle height.



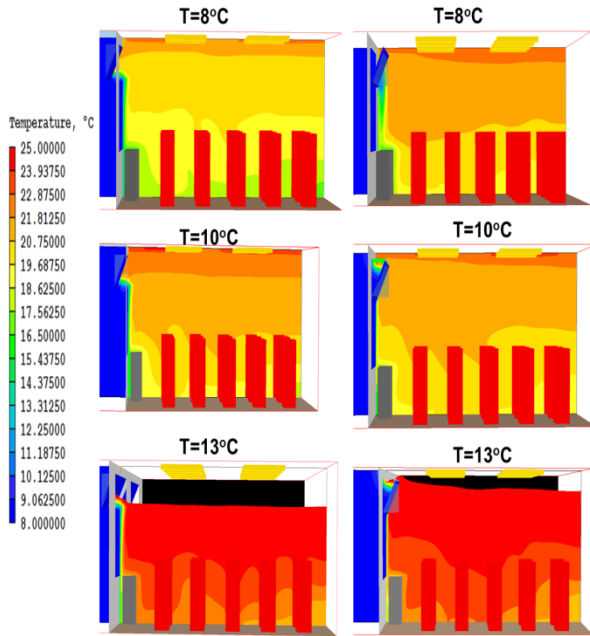

Figure 6: Vertical sections representing temperature fields for top hung-out(left) and bottom hung-in(right) for buoyancy driven natural ventilation scenarios.

The analysis of the results highlights that the internal values for airflow and air temperatures are affected mostly by the external temperature and the opening angle of the windows and less from the window type. Generally, for all the buoyancy-driven cases examined, the CFD results showed that within the classroom the temperature field could be divided into three gradient zones: the first zone close to the floor level, where the lowest predicted temperatures were found; the middle of the room; and close to the ceiling where the highest temperatures were predicted. Similar results were reported by previous work (Song & Meng, 2015). The velocity fields showed two distinctive regions. One close to the floor level, where the highest values were found and the other approximately 0.6m above the floor where the velocities were significantly lower which indicates that the risk of cold draughts will be mainly at the floor level. Similar results were presented in previous experimental work (Heiselberg & Perino, 2010).

Figure 7 presents the PMV distribution inside the classroom when the outside temperature was 8°C. The selection of this temperature was because is the lowest outside temperature that the CFD predicted acceptable internal air conditions and it is more likely that the occupants might feel any discomfort conditions compared to the other cases. BB101 assumes that the metabolic rate for students is 1.2met while the clothing insulation during winter period is assumed 1.1clo and the minimum maintained indoor air temperature at 20°C (EFA, 2016). As highlighted from the graph, the CFD predicts a relatively uniform distribution of the PMV within the occupied zone. The effect of the cold draughts is more intense at the areas closer to the windows, since the value of the PMV for the occupants sitting closer to the windows are lower compared to the rest of the

classroom but are still within the proposed limits from BB101, see Table 3. Moving towards the back of the classroom, the PMV value at 0.6m AFL is increases and reaches the maximum predicted value of 0.1 at the back of the classroom.

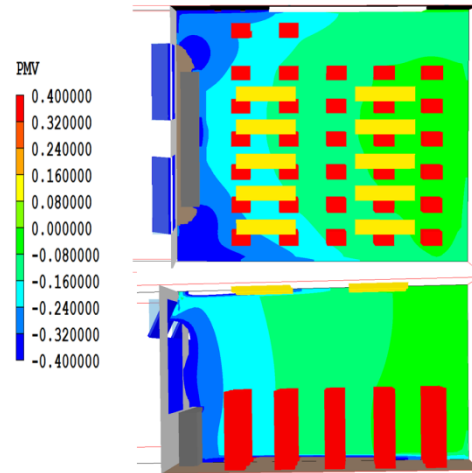

Figure 7: PMV distribution at 0.6m AFL (left) and vertical representation (right) for outside temperature of 8°C.

The last scenario for the buoyancy-driven cases assumed both the high and low level windows were open. As presented in Table 4, the provision of outside air was higher compared to the other cases. By opening the low-level windows the available free area of the windows increased and this resulted in higher provision of outside air. Although the outside temperature was 15°C, the CFD analysis predicted similar internal air temperature as with the previous cases,  $T_{\text{average}}=21.9^{\circ}\text{C}$ , due to the higher volume of outside air that entered the classroom. Similar to previous cases, the higher predicted air velocities were close to the windows and closer to the floor. Nevertheless, the predicted air velocity within the occupied zone was below 0.2m/s.

In addition, the CFD model was used to assess the performance of single-sided naturally ventilated classrooms under wind-driven forces. All the scenarios were investigated under constant external temperature with variable wind speed and the wind direction was always normal to the openings. The different wind speed captured cases with extreme outside conditions as well as with values close to the average wind speeds in the UK.

Table 5 compares the predicted provision of outside air as well as the average internal air temperature and velocity at different heights for the wind-driven natural ventilation scenarios. In all cases, the analysis revealed ventilation flow rates well above the optimum value of 8l/s/p. Due to higher pressure difference at the windows caused by the wind, the opening angle of the windows had to be smaller compared to the buoyancy cases in order to eliminate discomfort conditions in the occupied zone due to high internal air velocities.

Table 5: Predicted indoor air conditions using CFD for wind driven natural ventilation scenarios.

|   | Top hung-out high level openings |      |      |      |
|---|----------------------------------|------|------|------|
| Wind Speed[m/s]                               | 3.5                              | 5    | 7    | 10   |
| Ventilation rates [l/s/p]                     | 10.3                             | 10.6 | 10.4 | 9.8  |
| Stroke length [mm]                            | 240                              | 205  | 170  | 125  |
| $\Delta T_{\text{ankle-head}}$ [K]            | 1.86                             | 1.60 | 1.98 | 1.88 |
| $v_{\text{average}}$ [m/s] (0.1m above floor) | 0.26                             | 0.27 | 0.30 | 0.30 |
| $v_{\text{average}}$ [m/s] (0.6m above floor) | 0.13                             | 0.15 | 0.14 | 0.16 |
| $v_{\text{average}}$ [m/s] (1.4m above floor) | 0.11                             | 0.11 | 0.13 | 0.15 |

As mentioned in the buoyancy case, by controlling the opening of the windows it is feasible to maintain acceptable indoor conditions in single-sided naturally ventilated spaces. The temperature gradient between the ankle and the head is below the maximum allowed limit of 3K. The contour plot compares the velocity profiles inside the classroom for different outside conditions (Figure 8). The predicted internal air velocities were higher compared to the buoyancy cases. At the ankle height, the CFD analysis predicted velocities close to the maximum allowed limit of 0.3m/s. Although the opening of the windows was very small, the high external wind speed resulted in higher pressure differences at the openings and hence more turbulent flow inside the space. This observation suggested that pupils might experience cold draughts at ankle height. The placement of the furniture again had a major impact on the development of the velocity profile and on the elimination of cold draughts inside the occupied zone. Due to the small opening angle of the windows, the draught plume dropped closer to the vents compared to the buoyancy cases and hence the occupants closer to the openings were more likely to experience discomfort conditions. Generally, the development of the temperature was relatively uniform, with higher values closer to the ceilings and in the back of the classroom. The temperature of the air plume when it reached the occupied zone was well above the recommended value of 16°C (EFA, 2016), see Figure 9.

The analysis of the results revealed a positive correlation between the internal and external air speeds. For high external wind speeds the CFD analysis predicted higher internal velocities. Especially for the ankle height, the analysis predicted values above the maximum proposed from BB101 of 0.3 m/s (EFA, 2016). The analysis of the results suggested that there is no significant correlation between the predicted internal air temperature and the wind speed (Figure 9). CFD results indicated that the controlled opening of windows minimized the influence of the outside wind speed on the internal temperatures, since the results showed relatively constant internal air temperature for all the examined wind speeds. Comparing the results from the buoyancy-driven

scenarios with the wind-driven cases for a 10°C outside air temperature, it can be concluded that the values for the average internal air temperatures for both scenarios were similar. This demonstrates that there is a stronger relationship between the internal and external temperature than between the predicted internal air temperature and the ventilation forces, whether wind or buoyancy driven. The PMV distribution for the wind cases, not shown here, revealed similar results to the buoyancy case (Figure 7).

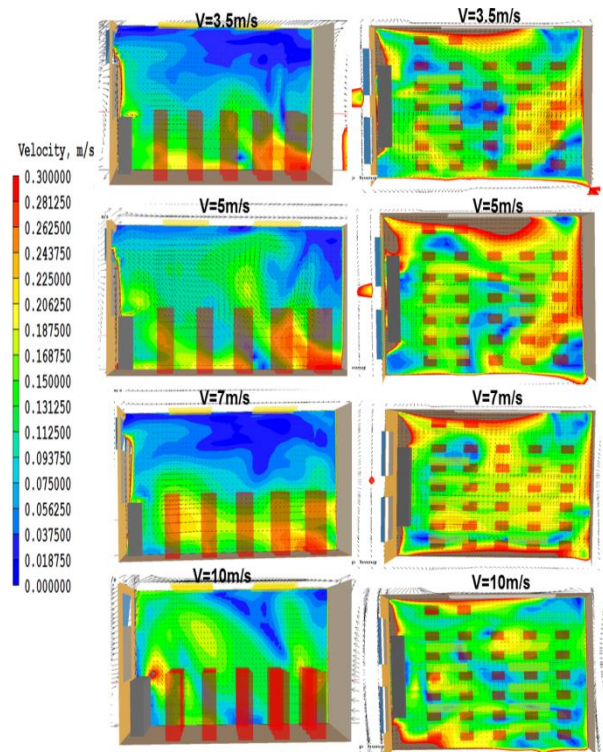

Figure 8: Vertical sections(left) and plan view at 0.6m above floor(right) for the top hung out wind driven strategies.  $V$  is equal to the wind speed.

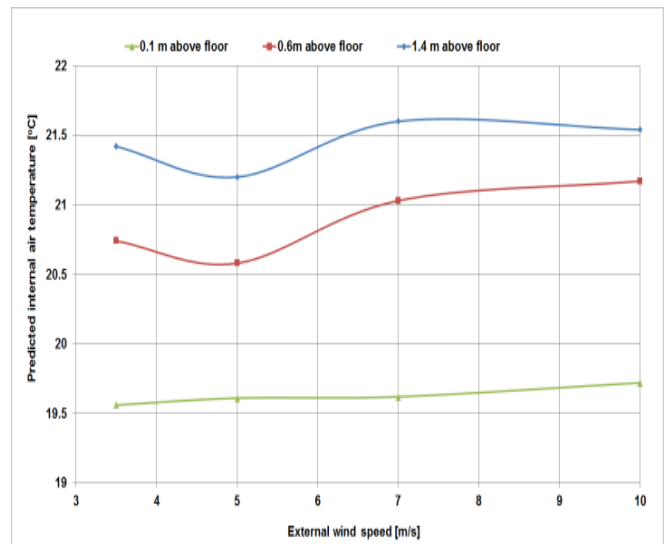

Figure 9: Predicted internal air temperatures for wind driven natural ventilation scenarios.

## Discussion and Conclusions

This paper has reported on the performance of naturally ventilated UK classrooms under various outside conditions during the heating season. The study has identified a gap in the knowledge regarding the control of natural ventilation systems and the identification of the external conditions under which a natural ventilation system could maintain thermally comfortable internal environments for a classroom, during wintertime. To address this, various natural ventilation scenarios were developed to investigate the performance of different window configurations, top and bottom hung, under different external air temperatures as well as different wind speeds to evaluate the classroom's thermal comfort. Predictions were made using CFD simulations. The results analysed the internal temperatures and air speeds as well as the predicted ventilation rates of a typical UK classroom and assessed against the recommended values from BB101 (EFA, 2016).

The CFD predictions suggest that by controlling the opening of windows it is feasible to maintain acceptable indoor conditions in single-sided naturally ventilated classrooms. More specifically, a single-sided natural ventilation system is a suitable ventilation strategy for classrooms when external temperatures are as low as 8°C and wind speeds are below 10m/s. Outside these parameters alternative ventilation strategies ought to be employed to ensure occupant comfort. The proposed ventilation strategy ensures the absence of cold draughts inside the classroom during a wide range of external air temperatures and wind speeds during wintertime. An innovative and inexpensive solution to eliminate the cold draughts within the occupied zone is the placement of furniture under the windows. As the analysis showed, this adjustment in the layout of the classroom minimises any discomfort that occupants might experience due to cold draughts. Using weather data for the region of Nottinghamshire for 1 year, during the period 1 June 2015 to 30 May 2016 (CEDA, 2016), it was found that during the occupied hours of a classroom (09:00-16:00) the average external temperature was within the proposed range 78% of the time. This means that for only 22% of the year, natural ventilation strategies would not be able to maintain thermally comfortable internal conditions for a classroom, based on the outcomes of this analysis. The results from the current study expand the knowledge from existing literature (e.g. Fitzgerald, 2012) by suggesting that it is feasible to use natural ventilation in a classroom when external temperature is as low as 8°C. The plots of the PMV demonstrate that a uniform thermal comfort distribution is feasible for a single-sided natural ventilation system during wintertime when high-level openings are used. Most importantly, the results have an immediate application for practicing engineers who will benefit from the design and control of windows by incorporating the natural ventilation strategies identified through this research. In this way, the findings from the current study and specifically the identification of the range of outside air conditions, 8°C to 13°C external temperature and

wind speeds below 10m/s, under which a single-sided natural ventilation system could provide adequate indoor air conditions, are highly applicable in industry and are readily available for commercial usage. This research contributes towards bridging the gap between institutional knowledge and commercial needs.

## Limitations and Future work

To reduce the computational time in this work, steady state simulations were performed which neglect the effect of time-varying phenomena such as variable external air temperatures or variable wind speeds and direction. Hence, it would be useful to conduct transient CFD simulations to investigate the extent to which CFD can be used to accurately model these phenomena. This would be particularly informative for wind directions oblique to, and parallel to the opening windows or the variation of the external air temperature.

The approach used here also neglects the behaviour of occupants, such as opening/closing windows, etc. These phenomena could be investigated using a coupled dynamic thermal simulation (DTS) / network airflow model followed by a series of steady state CFD simulations, carefully selected from the outcomes of the DTS / network airflow model.

Furthermore, it would be interesting to simulate the impact of solar heat gains in the ventilation performance of single-sided natural ventilation systems. In addition, it would be useful to compare the results against experimental data to examine the accuracy of the simulated results. Hence, future work should focus on collecting experimental data from a single-sided naturally ventilated classroom during wintertime and compare the measurements against the simulated data from this study.

## Acknowledgement

This research was financially supported by the Engineering and Physical Sciences Research Council (EPSRC) via the London-Loughborough Centre for Doctoral Training in Energy Demand (LoLo) (grant EP/L01517X/1).

## References

- Bakó-Biró, Z., Clements-Croome, D., Kochhar, N., & Williams, M. J. (2012). Ventilation rates in schools and pupils' performance. *Building and Environment*, 48, 215-223.
- Barrett, P., Davies, F., Zhaung, Y., & Barrett, L. (2015). The impact of classroom design on pupils' learning: Final results of a holistic, multi-level analysis. *Building and Environment*, 89, 118-133.
- CEDA. (2016). *Centre for environmental data analysis*. Retrieved 07 30, 2016, from <http://www.ceda.ac.uk/>



- CHAM. (2016). *CHAM Your Gateway to CFD Success*. Retrieved 08 31, 2016, from <http://www.cham.co.uk/>
- Chatzidiakou, E., Mumovic, D., Summerfield, A. J., & M, A. H. (2015). Indoor air quality in London schools. Part 1: "performance in use.". *Intelligent Buildings International*, 7(2-3), 101-129.
- Cheung, J. (2011). *CFD modelling of natural ventilation in multi-cellular spaces: Case study—ssee building*. London: In People and Buildings.
- Chiang, W. H., & Lai, C. M. (2009). The influence of ventilation design mixes on the thermal environment in elementary school classrooms. *Indoor and Built Environment*.
- CIBSE:KS6. (2006). *Comfort: Cibse knowledge series KS6*. London: Chartered Institution of Building Services Engineers.
- CIBSE. (2005a). *Natural ventilation in non-domestic buildings*. London, UK: Chartered Institution of Building Services Engineers.
- CIBSE. (2015). *GUIDE A: Natural ventilation in non-domestic buildings*. London,UK: Chartered Institution of Building Services Engineers.
- Coley, D., Greeves, R., & Saxby, B. (2007). The effect of low ventilation rates on the cognitive function of a primary school class. *International Journal of Ventilation*, 6(2), 107-112.
- Cook, M. J. (1998). An evaluation of computational fluid dynamics for modelling buoyancy-driven displacement ventilation. *Leicester, UK: De Montfort University*.
- Cook, M. J. and Lomas, K.J., (1998). Buoyancy-driven displacement ventilation flows: evaluation of two eddy viscosity turbulence models for prediction. *Building Services Engineering Research and Technology*, 19(1), pp.15-21.
- Dascalaki, E., Santamouris, M., & Asimakopoulos, D. (1999). On the use of deterministic and intelligent techniques to predict the air velocity distribution on external openings in single-sided natural ventilation configurations. *Solar Energy*, 66(3), 223-243.
- EFA. (2016). *Building Bulletin 101: Guidelines on ventilation, thermal comfort and indoor air quality in schools-Draft June*. London: UK Government.
- Fanger, P. (1977). Local discomfort to the human body caused by non-uniform thermal environments. *Annals of Occupational Hygiene*, 20, 285-291.
- Fitzgerald, S. (2012). *The science of cold draughts*. Retrieved 08 24, 2016, from <http://www.breathingbuildings.com/news/natural-ventilation-blog/the-science-of-cold-draughts>
- Heiselberg, P., & Perino, M. (2010). Short-term airing by natural ventilation-implication on IAQ and thermal comfort. *Indoor Air*, 20(2), 126-140.
- Iddon, C. R., & Hudleston, N. (2014). Poor indoor air quality measured in UK class rooms, increasing the risk of reduced pupil academic performance and health. The Grand Hall, The University of Hong Kong: Indoor Air: The 13th International Conference on Indoor Air Quality and Climate.
- Ji, Y., Lomas, K. J., & Cook, M. J. (2009). Hybrid ventilation for low energy building design in South China. *Building and Environment*, 44(11), 2245-2255.
- Jones, B. M., Cook, M. J., Fitzgerald, S. D., & Iddon, C. R. (2016). A review of ventilation opening area terminology. *Energy and Buildings*, 118, 249-258.
- Lauder, B. E., & Spalding, D. B. (1974). The numerical computation of turbulent flows. *Computer Methods in Applied Mechanics and Engineering*, 3(2), 269-289.
- Mendell, M. J., & Heath, G. A. (2005). Do indoor pollutants and thermal conditions in schools influence student performance? a critical review of the literature. *Indoor air*, 15(1), 27-52.
- PSBP. (2014). Baseline designs and strategies for schools, including for the Priority School Building Programme. *London, UK: Education Funding Agency*.
- Song, J., & Meng, X. (2015). The improvement of ventilation design in school buildings using CFD simulation. *Procedia Engineering*, 121, 1475-1481.
- Spentzou, E. (2015). Refurbishment of apartment buildings in the Mediterranean Region for natural ventilation: implications for building design, PhD thesis. *Loughborough, UK: Loughborough University*.
- Spentzou, E., Iddon, C., Grove, M., & Cook, M. J. (2016). Priority school building programme: An investigation into predicted occupant comfort during the heating season in naturally ventilated classrooms. *REHVA*.
- Stevanovic, Z., Ilic, G., Vukic, M., Zivkovic, P., Blagojevic, B., & Banjac, M. (2015). CFD simulations of thermal comfort in naturally ventilated primary school classrooms. *Thermal Science*, 00, 171-171.
- Visagavel, K., & Srinivasan, P. (2009). Analysis of single side ventilated and cross ventilated rooms by varying the width of the window opening using CFD. *Solar Energy*, 83(1), 2-5.
- Walker, C. E. (2005). Methodology for the evaluation of natural ventilation in buildings using a reduced-scale air model, PhD thesis. Boston,USA: Massachusetts Institute of Technology.
- Yakhot VS, Orszag SA, Thangam S, Gatski TB, Speziale CG. (1992). Development of turbulence models for shear flows by a double expansion technique. *Physics of Fluids A: Fluid Dynamics*, 4(7), 1510-2