

MODELLING AND CALIBRATION OF A DOMESTIC BUILDING USING HIGH-RESOLUTION MONITORING DATA

Dashamir Marini¹, Candy He¹, Richard Buswell¹, Christina Hopfe¹, and Dru Crawley²,

¹Building Energy Research Group, Loughborough University, UK

²Bentley software, US

ABSTRACT

Reducing energy consumption and managing energy supply/demand responses are key challenges facing the future built environment. The use of de-carbonised electricity to deliver space heating will make significant impact on CO₂ emissions for the UK. A likely technology in UK homes is to replace conventional gas boilers with heat pumps. A high coefficient of performance may mean a reduction in energy consumed, in addition the potential to contribute to demand side response through switching controlled via pricing signals. Evaluating the likely energy demand patterns from such systems and understanding how the characteristics of such systems might affect comfort can be estimated using building simulation. This paper describes the modelling and calibration process of an UK family dwelling using high-resolution monitoring data. Monitoring data describing gas, electricity, hot water, window operation and room temperature at minutely interval are used in the process.

INTRODUCTION

The housing sector accounts for more than a quarter of the overall energy consumption and CO₂ emissions in the UK; therefore represents a major opportunity to reduce energy consumption and CO₂ emissions (DECC 2013). Building performance simulation has been widely used to assess energy consumption in buildings and to estimate potential energy savings when applying retrofit options. However, large performance gaps between predicted energy consumption and actual measured data are often reported (Branco et al., 2004; Staepels et al., 2013). Model calibration is critical to bring simulated energy use closer to the actual consumption (Sun, 2014). There are a few common techniques that have been used for model calibration, which can be broadly categorized as manual and automated techniques (Coakley et al., 2014). There are advantages and disadvantages for both approaches. Manual calibration by tuning parameters in a trial and error manner could make the calibrated model more reliable and closer to the actual building (Raftery et al., 2011), but it is time consuming and cannot be easily replicated in another model. Automated calibration, on the other hand, using some form of optimization function, is more efficient to match the result numerically to the measured data, but may

not match the actual building physically (Garret et al., 2013). Calibrated models have been shown to reduce the gap between simulation and measurements results by systematically adjusting the input parameters (Mihai and Zmeureanu, 2013). In addition, the implementation of dynamic schedules (e.g. occupancy, equipment, lighting and HVAC schedules) can be used to represent more closely the actual activity in the building, resulting in a more realistic set of inputs (Mahdavi, 2001). This paper is a follow-up study in order to investigate hot water demand in buildings (Marini et al., 2015a,b). In this paper, we adopted a manual calibration approach to calibrate a UK family dwelling using high-resolution monitoring data.

CASE STUDY

A typical family dwelling located in the East Midland area in the UK was chosen in this study. It is a detached, two storey, four bedroom house with a total floor area of 140m². The building was constructed in the mid 1970s, with insulated cavity wall and double glazing windows. Heating and hot water is provided instantaneously by a condensing combi-boiler (type: Worcester 29H), serving radiators of varying size and style throughout the house. All radiators have manually controlled thermostatic radiator valves. The house is occupied by two adults and two children aged 11 and 8. Figure 1 shows the front view of the real dwelling. Figure 2 shows the floor plan of the dwelling. This dwelling is part of a larger study in energy demand reduction that were monitored in significant detail (Buswell et al., 2013). The electrical systems were monitored using a wireless proprietary system that connects CT devices and plug monitors to a central hub which transmits that data from the homes to a centralised database at a sample rate of 1 minute. The power measurements were used to measure energy consumption by electric showers, hobs and ovens. Room temperatures were also monitored with this system at a sample rate of 2 minutes. Temperatures on the flow pipe serving the heating systems were also measured to determine when the heating systems were on. The hot water flow rate was measured at a sample rate of 1 second to capture the characteristics of the water draw-off volumes and durations. A turbine flow rate sensor has been placed in the cold water pipe-line of the boiler in order to measure the produced hot water flow rate. The surface temperatures of the copper



Figure 1: Front view of the dwelling located in Loughborough, UK.

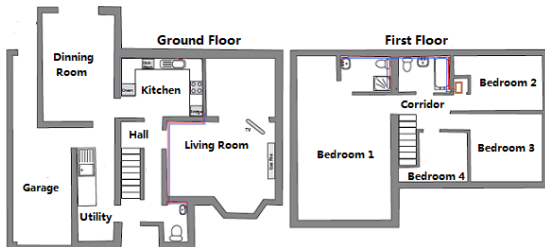

Figure 2: Internal layout of the 2-storey dwelling.

pipes at these inlets and outlets were used to indicate the water temperature and estimate the heat used. The energy supplied to the buildings by gas was estimated taking the calorific value of gas to be 39.5 MJm^{-3} and measuring the volumetric flow rate at a sample rate of 1 second.

METHODOLOGY

In this study, the Design Builder software (version 4.2) is used to create a base line model of the building while EnergyPlus (version 8.4) is used to run the baseline model and to develop the calibration process. The baseline model is calibrated through several steps and validated with real measured data obtained from the case study.

Baseline Model

The building's wall construction and fabrics thermal properties are inserted into the baseline model ($U = 0.65 \text{ W/m}^2\text{K}$). The simulation model (Figure 4) is based on the buildings geometry, layout and measured dimensions. It has twelve zones, including: four bedrooms, two bathrooms, one living room, one kitchen, one utility room, two halls (corridors) and one toilet. The design parameters for heating set point, infiltration/ventilation, power consumption, occupancy and operation schedules are inserted based on the

software's default values. These default values are based on CIBSE (2006, 2004, 2009) and the UK National Calculation Methodology (NCM) (BRE, 2014) in compliance with PartL2A of the building regulations.

Table 1 presents the design parameters that are used in the baseline model for each of the building's zones. Heating and hot water is provided by a condensing combi-boiler (Figure 3) serving radiators of varying size and style throughout the house. All radiators have manually controlled thermostatic radiator valves. The heating system operates continuously with heating setpoint temperatures (dual heating setpoint setback $19\text{-}22^\circ\text{C}$ and 12°C) through each zone as defined in each hour of the day (see heating setpoint schedule). The radiators design output heating capacities and water mass flow rates are auto-sized from the software. The efficiency of the condensing boiler was assumed to be 75% and performance has been simulated as a function of the return temperature and part load ratio performance curves as based on suggested default values from the software.

Calibration Process

With respect to the building and its material thermal properties few information was available, therefore identical values from the baseline model have been used in the calibrated model. The monitored data from the real building was used to calibrate the baseline model. The data is measured at a minutely time step and includes: power consumption; hot water consumption; gas consumption; windows and doors opening profiles; heating system supply water temperature; zonal temperatures. The weather data such as outdoor dry bulb temperature, wind speed and solar normal/diffused radiations was measured local to the building as well and was used instead of the softwares default weather file. The time-varying measured data was converted to schedule files which then were used to calibrate the corresponding input parameters. The input parameters were systematically calibrated in individual steps (hereafter called revisions) to the baseline model. Table 3 summarizes the revisions (calibration issues) in a sequential order implemented to calibrate the baseline model with the measured data.

In the calibration process, some assumptions were made. For the ventilation, an on/off schedule was assigned for each door and window as detected from sensors, however the opening angle could not be recorded therefore an assumption was made (as described in R3) in order to estimate windows/doors opened surface area. Similarly, in case of the infiltration, no pressure tests were carried out, so an assumption regarding the infiltration rate was made to consider air infiltration through building fabrics and cracks. The boiler efficiency was estimated using high resolution (secondly timestep) measured gas consumption and estimated supply heat for the hot water production and

Table 1: Design input parameters for the baseline model.

Design Parameter	Unit	Zones					
		Kitchen	Livingroom	Bedroom	Bathroom	Hall	
Heating setpoint	°C	19	22	19	21	20	
Infiltration	ac/h	1.5	1	0.5	1.5	1.3	
Ventilation	l/s/person	10	10	10	12	10	
Equipment Power	W/m ²	3	3.9	3.6	1.7	1.6	
Lighting Power	W/m ²	5	5	5	5	5	
Occupancy	people/m ²	0.017	0.017	0.03	0.019	0.016	
Hot Water	l/m ² / day	1.05	0.72	0.53	4.85	0.53	

Table 2: Operation schedules for the baseline model.

Schedule	Zone	Time of Day (hour)																							
		1	2	3	4	5	6	7	8	9	10	11	12	13	14	15	16	17	18	19	20	21	22	23	24
Heating [°C]	Kitchen	12	12	12	12	19	19	19	19	19	19	12	12	12	12	12	12	19	19	19	19	19	19	12	12
	LivingRoom	12	12	12	12	12	12	12	12	12	12	12	12	12	12	12	22	22	22	22	22	22	22	22	12
	BedRoom	19	19	19	19	19	19	19	19	19	12	12	12	12	12	12	12	12	12	12	22	19	19	19	19
	BathRoom	21	21	21	21	21	21	21	21	21	21	12	12	12	12	12	12	21	21	21	21	21	21	21	21
	Hall	12	12	12	12	21	21	21	21	21	10	12	12	12	12	12	12	21	21	21	21	21	21	21	12
Occupancy [-]	Kitchen	0	0	0	0	0	0	0	1	1	1	0	0	0	0	0	0	0	0	0	0.2	0.2	0.2	0.2	0
	LivingRoom	0	0	0	0	0	0	0	0	0	0	0	0	0	0	0	0.5	0.5	1	1	1	1	1	0.7	0
	BedRoom	1	1	1	1	1	1	1	0.5	0.2	0	0	0	0	0	0	0	0	0	0	0	0	0	0.2	0.7
	BathRoom	0	0	0	0	0	0	0	1	1	1	0	0	0	0	0	0	0	0	0	0.2	0.2	0.2	0.2	0
	Hall	0	0	0	0	0	0	0	1	1	1	0	0	0	0	0	0	0	0	0	0.2	0.2	0.2	0.2	0
Equipment [-]	Kitchen	0.1	0.1	0.1	0.1	0.1	0.1	0.3	0.3	1	0.3	0.1	0.1	0.1	0.1	0.1	0.1	0.1	0.1	0.5	0.5	1	1	1	0.1
	LivingRoom	0.1	0	0	0	0.1	0.2	0.1	0.1	0.1	0.1	0.1	0.1	0.1	0.1	0.1	0.1	0.5	0.5	1	1	1	1	0.7	0.1
	BedRoom	0.1	0.1	0	0	0.1	0.1	0.3	1	1	0.5	0.1	0.1	0.1	0.1	0.1	0.1	0.5	1	1	0.3	0.2	0.1	0.2	0.1
	BathRoom	0.1	0.1	0	0	0.1	0.1	0.3	1	1	0.3	0.1	0.1	0.1	0.1	0.1	0.1	0.1	0.1	0.1	0.1	0.3	0.1	0.1	0.1
	Hall	0.1	0.1	0	0	0.1	0.1	0.1	0.5	1	0.5	0.1	0.1	0.1	0.1	0.1	0.1	0.1	0.3	0.5	0.7	1	1	0.7	0.3
Lighting [-]	Kitchen	0	0	0	0	0	0	1	1	1	1	0	0	0	0	0	0	0	0	1	1	1	1	0	0
	LivingRoom	0	0	0	0	0	0	0	0	0	0	0	0	0	0	0	0	0	0	1	1	1	1	1	0
	BedRoom	0	0	0	0	0	0	0	1	1	1	0	0	0	0	0	0	0	0	0	0	0.2	0.2	0.2	0
	BathRoom	0	0	0	0	0.5	0	0	1	1	1	0	0	0	0	0	0	0	0	0	0	1	1	1	0
	Hall	0	0	0	0	0.5	0	0	1	1	1	0	0	0	0	0	0	0	0	0	0	1	1	1	0

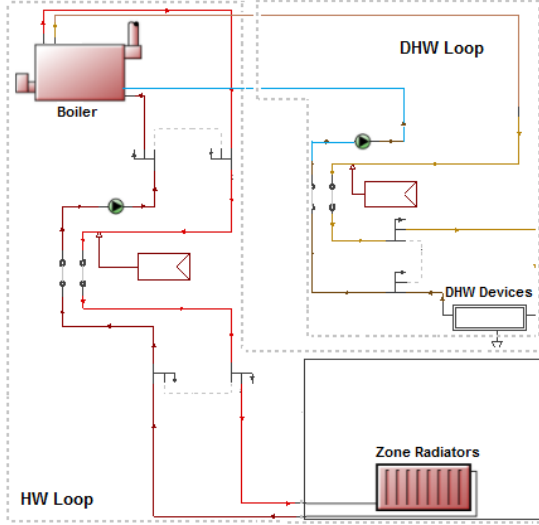

Figure 3: Diagram of heating and domestic hot water loops.



Figure 4: Building model 3D view.

the same efficiency was assumed for the boiler operating to provide space heating. The boiler's operation schedule was not retrieved from the gas consumption as it also includes the consumption from cooking but from the supplied water temperature measured on the boiler outlet pipe. The gas consumption was disaggregated between boiler and cooking consumption (based on measured water flow temperature) to estimate gas consumption from boiler however some uncertainties may exist in this estimation.

Validation Method

The statistical Mean Bias Error (MBE) method is often used for validation of the error between predicted and measured data. The MBE measures how close the energy use predicted by the model corresponds to the measured data on a monthly or annual basis, however the estimations may be influenced by offsetting errors. Therefore, an index that captures offsetting errors the so called Cumulative Variation of Root Mean Squared Error (CVRMSE) is considered as an appropriate validation index (ASHRAE, 2002). Equations (1 and 2) show how the statistical MBE and CVRMSE are calculated using the measured and simulated results.

$$MBE = \frac{\sum_{i=1}^{N_p} (M_i - S_i)}{\sum_{i=1}^{N_p} (M_i)} \quad (1)$$

$$CVRMSE_{(p)} = \frac{\sqrt{\sum_{i=1}^{N_p} ((M_i - S_i)^2 / N_p)}}{\overline{M_p}} \quad (2)$$

Table 3: Revisions (for calibration) implemented into the baseline model.

Revision No.	Calibrated performance aspect	Calibration description
R1	Power consumption	The power consumption and the hourly schedules for equipment and lighting are replaced with measured data. The power consumption was measured at five circuits and the equipment/lighting loads were obtained at zone level. The maximum power load values at zone level are used as design values. The fraction factors (as a function of maximum design values) are inserted in a corresponding schedule at a minutely timestep. This revised input was necessary in order to calibrate the power consumption and the internal heat gains in terms of the heating demand for space heating.
R2	Hot water use	The design values of the baseline model are replaced with the measured hot water use in the building. Similar to the power consumption, the fraction factors are inserted as a function of maximum design value (at corresponding timestep). The hot water supply outlet temperature was considered to be 50 °C (combi-boiler). This revision calibrate the volume of hot water use and as well influence the estimated gas consumption for domestic hot water production.
R3	Weather data	Weather data was measured close to the building site and is used to generate a weather simulation file for EnergyPlus. This revision influenced the outdoor conditions and therefore led to adapted heating energy demand and zones' temperatures.
R4	Boiler schedule and zone temperatures	The baseline model assume that boiler operate continuously to maintain design heating setpoint temperature presented at Table 2. The boiler operation schedule in the baseline model was calibrated by using an on/off schedule retrieved from measured data. The schedule is obtained based on the measured water supply outlet temperature from the boiler. The zonal heating design set point temperatures (dual setback) are calibrated using 21°C in all zones during the entire period. This revision influence heating system operation and zones design heating set points, consequently gas consumption.
R5	Boiler efficiency	The efficiency of the combi-boiler when producing hot water was estimated to be about 68% (rather than 90% as suggested in the regulations) as based on measured gas consumption and estimated supplied thermal heat (Buswell et al., 2013). For heating operation, the water mass flow rate in heating loop was not measured, so the supplied heat (consequently efficiency) was not able to be estimated based on measured data. The technical manual of the boiler (Worcester-boiler-manual) indicates that the seasonal boiler efficiency is about 89% for this model. ASHRAE (2012) provides a boiler efficiency curve (ranging from 82% to 99%) as a function of the inlet water temperature. The EnergyPlus simulation tool can model space heating and hot water production in two separate loops. Therefore, the estimated efficiency from measures was used hot water production, whilst the ASHRAE efficiency curve was used to estimate boiler efficiency during heating operation. This revision has a direct impact on the estimated gas consumption for space heating and hot water production.
R6	Infiltration and ventilation	For a more realistic estimation of infiltration and ventilation, the airflow network method is applied. This method provide the ability to simulate multi-zone airflow network driven by movement of openings (windows/doors) and wind speed/directions from weather data. When the airflow network is implemented, the EnergyPlus tool disregards the design infiltration and ventilation design values (from the baseline model) and estimates ventilation flow rates based on the windows/doors opening surface area and the operation schedule (as obtained from windows/doors monitoring). The amount of air infiltrated into the building is then estimated from the program based on crack surfaces area and air infiltration crack factor (the default values for the infiltration coefficient suggested by the program were taken). The windows/doors opening surface area is not a practical measurement and difficult to estimate. In the simulation, a factor of 20% (for windows) and 70% (for doors) of the total surface area is considered as opening surface area. This revision impacted the heating demand (and therefore gas consumption) as well as zones air temperature.
R7	Radiators water flow	For the baseline model, the water mass flow rate through the radiators was auto-sized by the simulation tool. For auto-sized method, the water mass flow rate is distributed in a sequential way, meaning that the first radiator in the heating loop has the maximum mass flow rate (to meet zone heating demand) followed by the second radiator with highest water mass flow rate and so on until the last radiator. The water flow rate was not measured, however based on the zonal design heating loads estimated from the simulations and considering a temperature difference through the heating system, a maximum design flow rate can be estimated for each radiator in each zone. Using this method, the supplied heat in the system is expected to be distributed in a more uniform way. The maximum boiler water supply temperature for the heating system is set to 47 °C (as observed from the measured data). The simulation tool modulates the water mass flow rate through the radiators in order to meet the heating demand in each zone. This revision impact supplied heat from the radiators, zones temperatures and gas consumption from boiler.

Table 4: Error analysis: simulated models vs. measured results.

Model	Error Gap (%)					
	Gas			Electricity		
	MBE(m) ¹	CVRMSE(d) ²	CVRMSE(h) ³	MBE(m)	CVRMSE(d)	CVRMSE(h)
BaseLine model	+35.2	+42.4	+110.6	-22.3	-27.8	-82.6
R1	+30.3	+39.2	+108.7	+0.8	+1.3	+4.6
R2	+27.4	+32.6	+102.4	+0.4	+1.1	+5.6
R3	+20.6	+23.2	+96.4	+0.4	+1.1	+5.2
R4	-26.3	-29.8	-56.2	-5.2	-5.8	-6.6
R5	-22.4	-26.3	-51.4	-4.9	-5.3	-5.7
R6	-15.2	-20.3	-48.7	-3.8	-4.2	-4.9
R7	-3.7	-15.5	-46.7	-2.3	-3.1	-4.2

¹(m) monthly; ²(d) daily; ³(h) hourly; positive (+) values indicate that simulated results over-predict actual measured consumption, vice versa for negative (-) values.

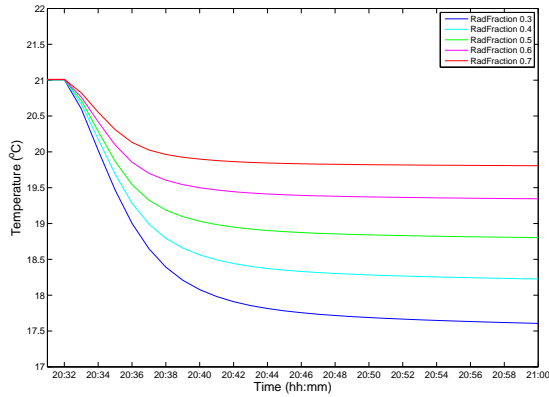

Figure 5: Operative temperature drop (in the living room) consequence to varying inputs for radiant fractions supplied heat.

where: M_i and S_i are measured and simulated data at instance i respectively; p is the interval (e.g., monthly, daily, hourly); N_p is number of values at interval p (e.g., number of month, days, hours); and \overline{M}_p is the average of measured data, i.e.,

$$\overline{M}_p = \frac{\sum_{i=1}^{N_p} (M_i)}{N_p} \quad (3)$$

RESULTS AND DISCUSSIONS

The calibration process requires all measured parameters at a minutely timestep. In reality, it is almost impossible to assure continuous supply of measured data for all required parameters over a long period of time (as a consequence of measuring devices failures). That is why the calibration and results validation were carried out only over the duration for one month (i.e., February 2013) where measured parameters were available. Figure 5 shows the operative temperature drop as a function of the radiation fraction of supplied heat. In EnergyPlus, the supplied heat from the radiators can be divided into fractions of convective and radiant heat delivery. The heat supplied through convection, heats the room's air temperature, whilst the heat supplied via radiation heats inside the wall surfaces. For a radiant fraction of 0.3 (30% radiation supplied heat) the operative temperature drops quicker (meaning less thermal energy stored in the internal mass) as compared with a radiant fraction of 0.3 and so on for other fractions. The EnergyPlus input/output manual (US Department of Energy, 2016) suggest that for an air velocity in rooms of less than 0.2m/s the radiation fraction can be considered 0.5 while for a velocity 0.2 to 0.6m/s, the radiant fraction can be considered 0.4 (0.4 was considered in the simulation models).

Figure 6 shows the results from the calibrated model (after all revisions have taken place, i.e. after revision R7) and the measured results during a two days running period. The zone temperature (top plot) in the figure shows that the measured temperature has a slow rise-up and drops compared to the simulated

temperature which reaches the design heating set point and then drops quicker. This difference might be influenced by the heating supply temperature from the boiler and the heat transfer from the radiator to the room. The boiler supply temperature (second plot) shows that the measured temperature rises from 20°C to about 47°C. In terms of the simulated model the temperature rises from 42°C to 47°C (considered $\Delta T = 5^\circ\text{C}$). The considered temperature difference in the model disregards the necessary heat to be provided by the boiler to heat up the water volume (in heating loop and radiators) from ambient temperature (when the boiler switches on) up to the design supply outlet temperature. After the system is switched-off, the measured supply/return temperatures drop slowly, whilst the simulated outlet temperature drops to the design inlet temperature and stays constant until the boiler is switched-on again. The outlet/inlet temperatures influence not only the supplied heat (and therefore the room temperature) but also the gas consumption of the boiler. This can be observed (on the third plot) where the measured gas consumption during the boiler start-up has a maximum gas consumption which is twice as high as compared to the simulated results. Based on the boiler's technical manual, the combi-boiler is fitted with a gas flow regulator which modulates the gas consumption as a function of the return water inlet temperature. The simulated model however estimates the gas consumption based on the heating demand and the boiler efficiency (where for nearly a constant return water temperature of 42°C it was about 86%). This can be seen where the temperature is slightly higher during the boiler start-up and decreasing slowly while the system is running where zones temperature rise and the heating demand decreases. The bottom plot shows the boiler on/off schedule where for space heating it mostly operate from 5:45am to 8:30am in morning and from 4:30pm to 8:30pm or up to 11:30pm in afternoons. Figure 7 shows the variance of the normalized gas consumption at an hourly timestep over a one month period. The measured gas has a higher median consumption when compared to the simulated consumption at the hours of first operation. This is when the boiler starts-up (6am and 5pm) reflecting a higher consumption to heat up the water volume in the system where the temperature rises to about 27°C rather than 5°C as considered in the model. For other operational hours, the simulated results are slightly higher when compared to the measured. In the real system the boiler modulates the gas consumption (and switches it on/off) based on the return inlet temperature. The model however operates continuously (although slightly reducing the gas consumption) and modulates the water mass flow rate in order to maintain the design heating setpoint temperature. The baseline model has a lower variance however the model assumes that the boiler operates continuously over the entire day in order to maintain the de-

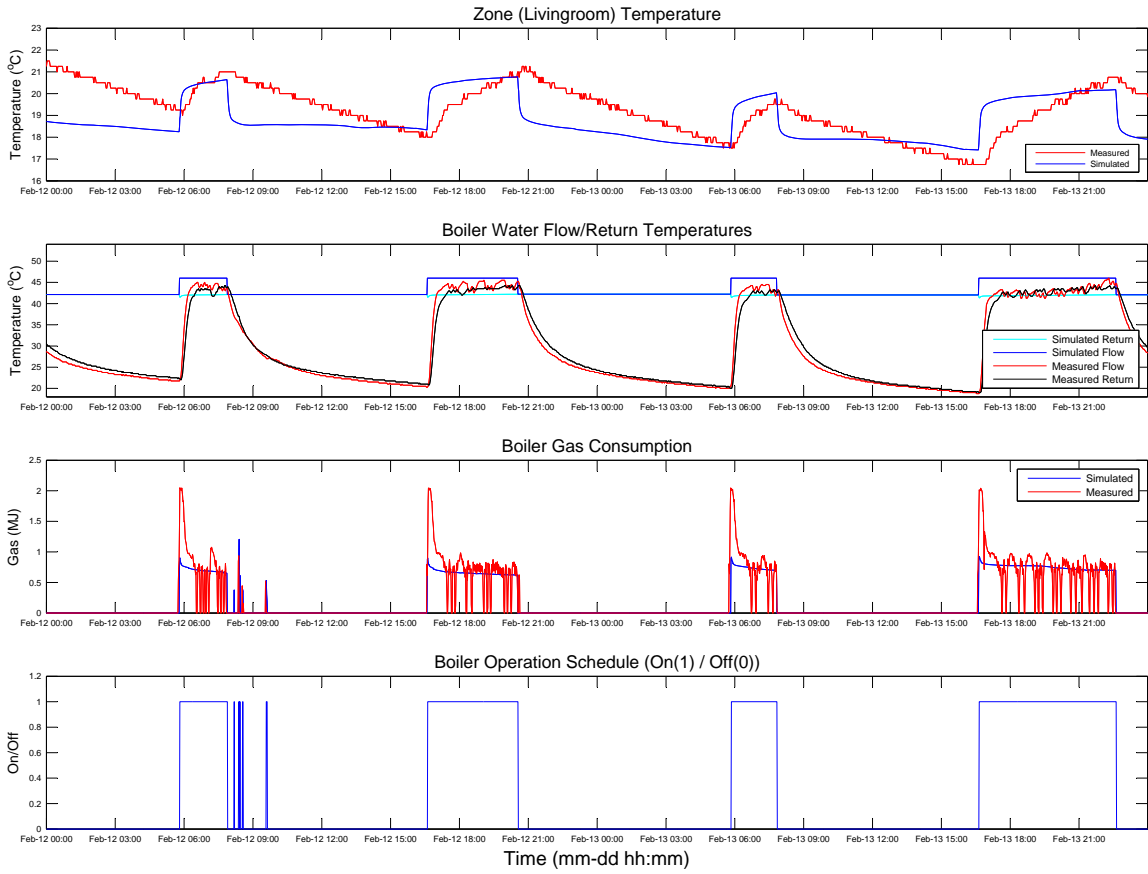

Figure 6: Comparison of revision (R7) vs. measured results during two days running period.

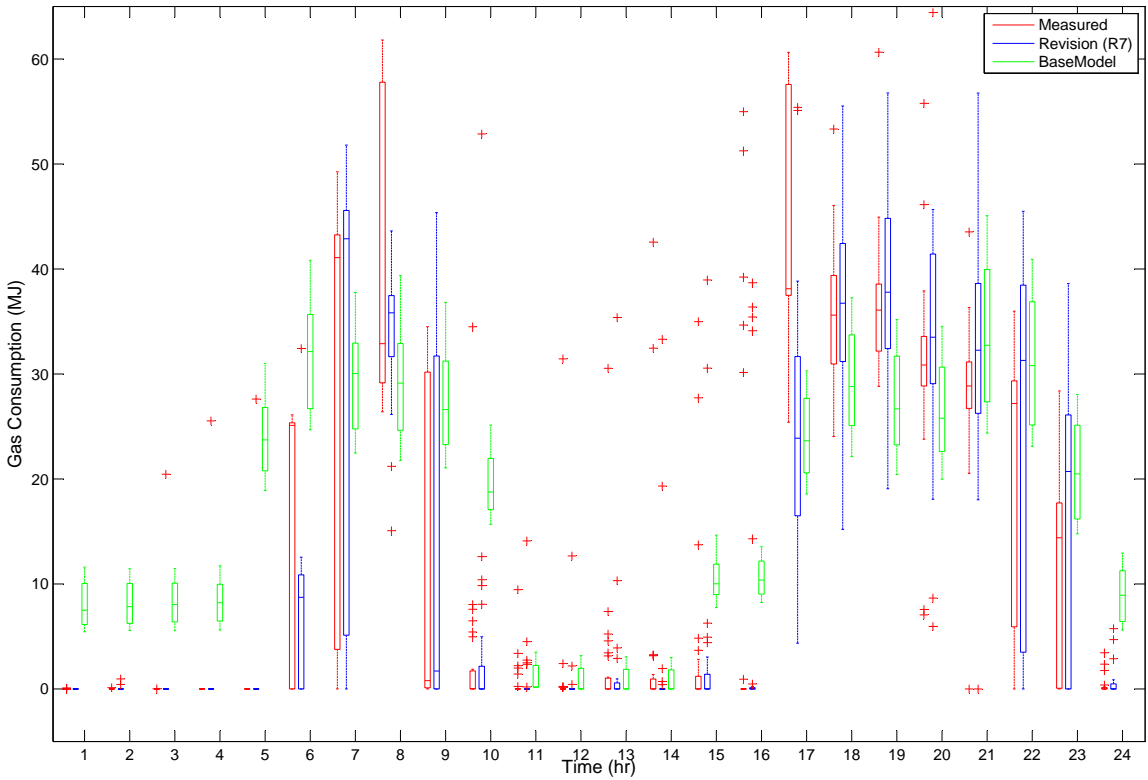

Figure 7: Variation of gas consumption: measured vs. baseline and revision (R7) model as normalized at hourly timestep for one month time period - the central mark is the median, the edges of the box are the 25th and 75th percentiles, the whiskers extend to the most extreme data points not considered outliers.

sign heating set points. Figure 8 shows a comparison of the measured gas consumption versus the simulated where each point in the plot presents the gas consumption during one hour period. Some of the measured results have a higher consumption as compared to the simulated whilst other hours are closer to each other or the simulated result is higher. This again reflects the differences presented in Figure 6. The linear fit line however shows that the measured model shows a higher consumption compared to the simulated model. Figure 9 presents a comparison of the power consumption between the measured, calibrated and the baseline model during a one day period. The calibration approach brings the modelled consumption very close to the measured consumption whilst the baseline model has a lower peak but a slightly higher consumption during morning and evening hours. Figure 10 presents the total energy consumption (gas and electricity) during a one month period as estimated from the baseline model, the calibrated model and the measured results. The baseline model shows the highest consumption. The calibration process (R1-R4) decreased the gas consumption whilst revision (R5-R7) increased the predicted results. The impact of the calibration on the predicted results is summarised in Table 4 which shows an error analysis of the simulated model versus the measured results. The validation was conducted for gas and electricity consumption at monthly, daily and hourly intervals. The baseline model for example overestimates the gas consumption by about 35% (monthly validation) whilst the power consumption was underestimated by about 22%. For daily and hourly validations, the results show a higher error gap for all revisions. Calibrating the power consumption (R1) reduces the gas consumption by about 5% whilst the error gap for power drops at a level of 0.8%. The revision (R2) reduces the volume of hot water use from 3.2m³ to 2.7m³ and slightly reduces the gas consumption. Weather data calibration (R3) had also an impact reducing the gas consumption (actual measured outdoor air temperature was higher compared to the outdoor air temperature in a typical reference year weather simulation file). The revision (R4) of the boiler schedule had the highest impact on the reduction of the gas consumption compared to the baseline model. The heating system from the baseline model operates continuously (24 hours a day with dual setback setpoint temperature for some hours) to maintain the design heating set point temperature, whilst the real system operates only about 7-11 hours a day (depending on it being a weekday/weekend). A higher boiler efficiency (R5) as compared to the baseline model reduces the gas consumption. Calibration of infiltration and ventilation (R6) reduced also the gas consumption, meaning that the assumed constant design values from the baseline model were higher compared to the calibrated model causing more heat loss due to infiltration/ventilation. The calibration of the

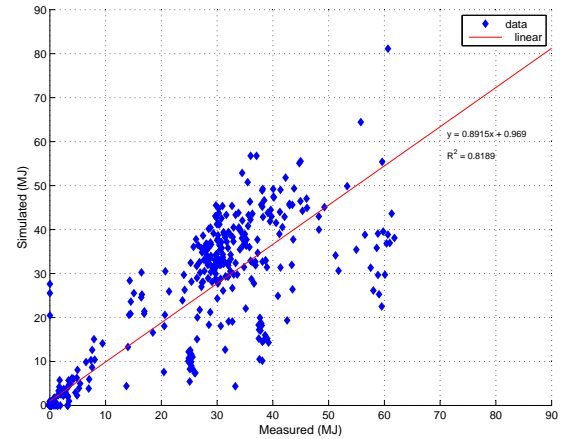

Figure 8: Gas consumption: simulated (R7) vs. measured.

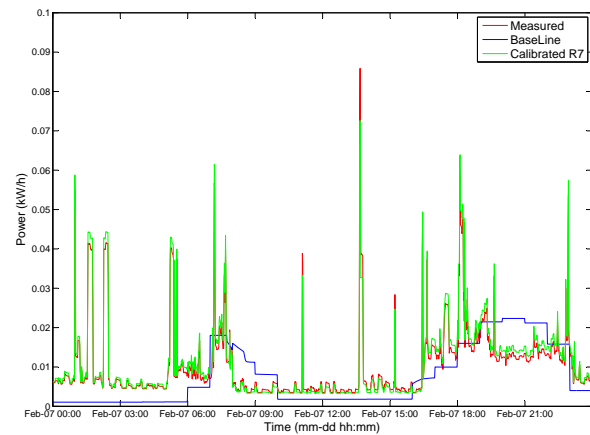

Figure 9: Comparison of power consumption measured vs. calibrated model (R1) and baseline model.

radiators water mass flow rate (R7) and the load distribution method also impacted on the gas consumption. The auto-sizing method underestimated the maximum design water mass flow rate which in turn resulted in lower heat delivery and as consequence led to less gas consumption. The power consumption, after revision (R1) changed slightly which was influenced by the power consumption from circulating pump in the heating system.

CONCLUSIONS

In this paper, we have developed a calibration methodology using high frequency monitored data for dynamic analysis over the period of one month using Energy+. In total, seven revisions were undertaken to the baseline model (that initially was created according to building standards for a domestic dwelling) and simulation outputs were validated at monthly, daily and hourly time steps against the measured results.

It was found that for the monthly timestep validation, the baseline model overestimated the gas consumption by about 35% whilst the power consumption was underestimated by about 22% compared to the measured data. This calibration methodology reduced the error

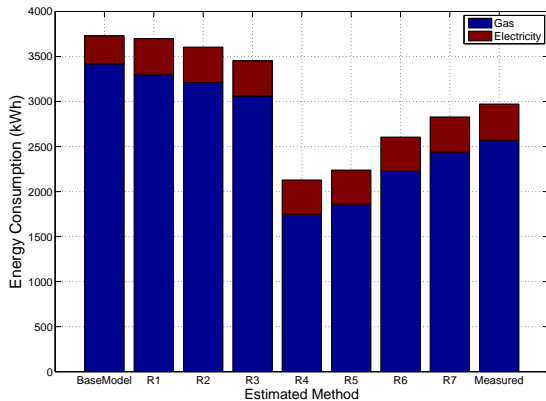

Figure 10: Estimated energy consumption from base-line model, calibrated models and measured results.

gap to about -4% and -2% for gas and power consumption, respectively. The revision aspects such as the boiler operation schedule, infiltration/ventilation, radiators water mass flow rate and weather data were found to be most influential with respect to the error gap between measured and simulated results for the gas consumption. In terms of the daily and hourly validation, the error gap was found to be higher (especially in the hourly time step). The difference might be influenced by the temperature rise in the heating system.

From our time-series results it is however evident that the results show high levels of disagreement arising from the program's inability to capture detailed system dynamics and delay times. For example, the difference of the boilers temperature rise (in degree Celsius) between simulation model and reality; occurrence of peak consumption based on boiler timing; timing of radiators supply heat (including maximum temperatures), amongst others. In this context, further research is needed. For example, the development of a model that appropriately accounts for the systems time constants. This would help to predict gas consumption more accurately (especially during the boilers start-up) and also the radiators thermal heat output.

To conclude, the calibration process reduces the error gap between the simulated and measured results significantly, however the simulated model is not able to capture precisely the realistic behaviour of the system. For the purpose of future work, we anticipate to use our high resolution monitoring in tandem with a different simulation program in order to reproduce long time horizon patterns with respect to hot water demand in buildings.

ACKNOWLEDGEMENT

This paper forms part of the work produced under the HotHouse Project based at Loughborough University, UK. The work was funded through the TEDDI call managed by the RCUK Digital Economy and Energy programmes (EPSRC Grant Number EP/M006735/1).

REFERENCES

- ASHRAE 2002. Measurement of Energy and Demand Savings. *ASHRAE Guideline 14-2002*.
- ASHRAE 2012. HVAC Systems and Equipment. *ASHRAE Handbook*.
- Branco, G., Lachal, B., Gallinelli, P., and Weber, W. 2004. Predicted versus observed heat consumption of a low energy multifamily complex in switzerland based on long-term experimental data. *Energy and Buildings*, 36:543–555.
- BRE 2014. UK National Calculation Methodology. (UK NCM). A technical manual for SBEM. BRE.
- Buswell, R., Marini, D., Webb, L., and Thomson, M. 2013. Determining heat use in residential buildings using high resolution gas and domestic hot water monitoring. *BS13, France*.
- CIBSE 2004. CIBSE Guide F: Energy efficiency in buildings. ISBN 1-903287-34-0.
- CIBSE 2006. CIBSE Guide A: Environmental Design. ISBN-10: 1-903287-66-9.
- CIBSE 2009. CIBSE Guide H: Building control systems. ISBN-10: 0750650478.
- Coakley, D., Raftery, P., and Keane, M. 2014. A review of methods to match building energy simulation models to measured data. *Renewable and Sustainable Energy Reviews*, 37:123141.
- Garret, A., New, J., and Chandler, T. 2013. Evolutionary tuning of building models to monthly electrical consumption. *ASHRAE Transactions*, 119(PART 2), pp.8999.
- Mahdavi, A. 2001. Simulation-based control of buildings system operation. *Building and Environment*, 66:789–96.
- Marini, D., Buswell, R., and Hopfe, C. 2015a. A critical software review- how is hot water modelled in current building simulation? *BS15, India*.
- Marini, D., Buswell, R., and Hopfe, C. 2015b. Estimating heat from domestic hot water systems in uk dwellings. *BS15, India*.
- Mihai, A. and Zmeureanu, R. 2013. Calibration of an energy model of a new reserch center building. *BS13, France*.
- Raftery, P., Keane, M., and Costa, A. 2011. Calibrating whole building energy models: Detailed case study using hourly measured data. *Energy and Buildings*, 43:3666–3679.
- Staepels, L., Verbeeck, G., Roels, S., Gelder, L.V, P., and Bauwens, G. 2013. Energy performance labels for dwellings versus real energy consumption. *BS13, France*.
- Sun, K. 2014. A pattern-based automated approach to building energy model calibration. *Applied Energy*, 165:214224.
- US Department of Energy 2016. The Encyclopedic Reference to EnergyPlus Input and Output. .
- Worcester-boiler-manual . <https://www.worcesterbosch.co.uk/products/boilers/directory>.