

This item was submitted to Loughborough's Institutional Repository (<https://dspace.lboro.ac.uk/>) by the author and is made available under the following Creative Commons Licence conditions.



**CC creative commons**  
COMMONS DEED

**Attribution-NonCommercial-NoDerivs 2.5**

**You are free:**

- to copy, distribute, display, and perform the work

**Under the following conditions:**

**BY:** **Attribution.** You must attribute the work in the manner specified by the author or licensor.

**Noncommercial.** You may not use this work for commercial purposes.

**No Derivative Works.** You may not alter, transform, or build upon this work.

- For any reuse or distribution, you must make clear to others the license terms of this work.
- Any of these conditions can be waived if you get permission from the copyright holder.

**Your fair use and other rights are in no way affected by the above.**

This is a human-readable summary of the [Legal Code \(the full license\)](#).

[Disclaimer](#) 

For the full text of this licence, please go to:  
<http://creativecommons.org/licenses/by-nc-nd/2.5/>

# Investigating the performance of a combined Solar System with Heat Pump for houses

MUHAMMAD WASEEM AHMAD<sup>1</sup>, DR. MAHROO EFTEKHARI<sup>1</sup>, DR. THOMAS STEFFEN<sup>2</sup>,  
ABDULHAMEED MAMBO DANJUMA<sup>1</sup>

<sup>1</sup>SCHOOL OF CIVIL AND BUILDING ENGINEERING, <sup>2</sup> SCHOOL OF AERONAUTICAL, AUTOMOTIVE,  
CHEMICAL AND MATERIALS ENGINEERING,  
LOUGHBOROUGH UNIVERSITY,  
LOUGHBOROUGH, UK

[M.W.Ahmad@lboro.ac.uk](mailto:M.W.Ahmad@lboro.ac.uk), [M.M.Eftekhari@lboro.ac.uk](mailto:M.M.Eftekhari@lboro.ac.uk), [T.Steffen@lboro.ac.uk](mailto:T.Steffen@lboro.ac.uk),  
[A.D.Mambo@lboro.ac.uk](mailto:A.D.Mambo@lboro.ac.uk)

## Abstract

The UK government has committed to generate 20% of the country's energy from renewable sources by 2020. This paper investigates energy reduction in houses by using an innovative solar thermal collector combined with a heat pump system. The dynamic lumped parameter model for a small house is derived and the combined heating system is used to provide the typical hot water and heating requirement. The goal is to maintain thermal comfort inside the house and reduce the amount of electricity consumption used for heating and hot water. This is achieved by reducing the electricity costs through optimising the operation of the heat pump, integrating the available solar energy, and by shifting electricity consumption to the cheaper night time tariff. Models of conventional controller on-off and a multi-variable model predictive control (MPC) are developed and used for several different climatic conditions. The results showed that the model predictive controller performed best by providing better comfort, consuming less electric energy and better use of cheap night time electricity by load shifting and storing heat energy in the heating tank.

## Keywords

Model predictive controller, Heat pump, Conventional control strategies, Load shifting, Solar energy

## 1. Introduction

According to the International Energy agency [1] the primary energy use has grown by 40% from 1994 to 2004. Overall there is an average energy and CO<sub>2</sub> increase of 2% and 1.8% each year respectively. The main source of energy consumption in the domestic sector is space heating, which accounted for 60% of the total domestic energy consumption in 2011. Water heating accounted for 18%, lighting 19% and cooking for a 3% [2] of a typical household bills. Currently, the use of solar thermal collectors combined with heat pump systems is becoming popular due to their low electrical cost. A heat pump is mainly used to increase the temperature of hot water generated by the solar collectors. It is acknowledged that the solar heating systems are challenging to control due to the swings in day to day and season to season energy flows and also the varying thermal comfort demands. The control system is an important component of any renewable system and is critical for increasing the performance of such systems.

The long-term performance of a combined solar collector and heat pump system was studied by Huang et al.[3] and was found that its electricity price was cheaper than conventional gas system. The performance of a solar-assisted heat pump water heating system was monitored by Hawlader et al.[4] . They showed that the performance of the system is influenced significantly by collector area, speed of the compressor, and solar irradiation. The performance of a combined solar water heater and heat pump was investigated by Nutaphan et al.[5] using a simulation program. The economical mass of hot water in the storage tank and the refrigerant mass flow for optimum operation of the system were investigated. Predictive control strategies are well known in building control research [6]. An MPC is used for chillers to optimally store the thermal energy in the tanks by using the predictions of the building load and outside weather conditions [7]. In another study a detailed building model is applied for building predictions [8]. Model predictive control has also been used for reducing peak electricity demand in building climate control [9]. Different predictive control strategies for a solar hot water system with non-predictive strategies are compared by Grünenfelder et al [10]. It is shown in simulation that for a small storage tank, the predictive control saves energy

cost when compared with non-predictive strategies. A weather predictor based on observed weather data is used by Henze et al [11-13]. The system under study uses active and passive building thermal storage systems. Building heating systems using MPC with weather prediction have shown to save between 15% and 28% of the energy consumption [14].

This paper will investigate the performance of a combined solar thermal collector and heat pump system. To control the system, a conventional (on-off) and an advanced control system (MPC) are simulated and the energy saving and load shifting of the controllers are compared. Mathematical model of the building and heating system is developed to predict the future behaviour of the whole system according to the outdoor weather conditions and occupancy pattern of the building.

## **2. Experimental Heating system**

The full size solar system and the heat pump are installed at the School of Civil and Building Engineering of Loughborough University. It consists of a solar panel, a heat pump and three accumulator tanks. The buffer tank is heated up with the help of a heat pump and when it is required this hot water is transferred into either the heating tank or the hot water tank. The heating tank is also connected to the solar thermal collector. During the night, when electric tariffs are low, the heat pump can be used to heat up all the tanks.

A general schematic diagram of the system is shown in Figure 1. The heat pump is connected to the buffer tank.

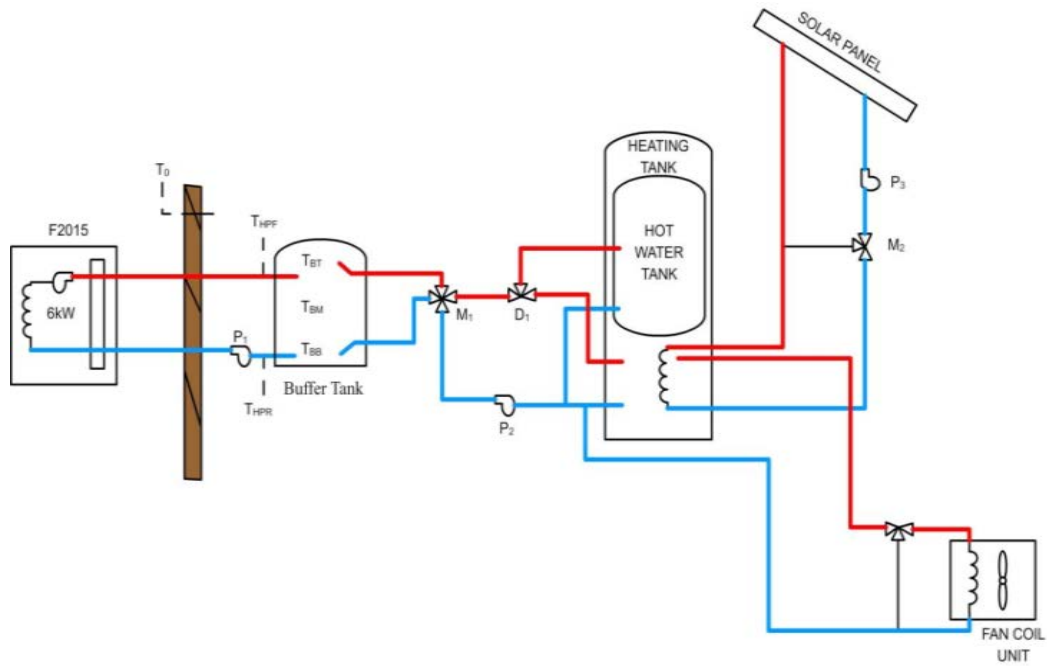

Figure 1: Solar System Combined with Heat Pump Schematic

The main components of the system are described below.

## 2.1. Accumulation System

The accumulation system consists of three tanks. The first tank is the buffer tank for the heat pump, and it has a capacity of 300l. It is heated by the heat pump, and it can supply hot water to the other two tanks as required. The hot water tank is connected to the buffer tank, it has a capacity of 300l, and it is located inside the heating tank. The heating tank is 450l capacity, and it provides hot water to the room fan coil units for heating.

## 2.2. Solar Collector

Solar collectors are used to collect solar radiations and to raise the water temperature of the heating tank. It is the preferred energy source of the system, because it uses only a minimal amount of electricity to power the circulation pump. The solar collector consists of 2 flat plate collectors  $2m^2$  in area each, covering a total area of  $4m^2$ .

## 2.3. Heat Pump

The installed system is a single stage air source heat pump. It is the only way to heat the hot water tank, and it can be used as an auxiliary energy source for the heating tank when necessary. The heat

pump is directly connected to the buffer tank. The rated electric power of the heat pump is 6kW, but the actual power consumption may be lower, and the delivered thermal power is higher due to the additional energy drawn from the heat source.

The single heat pumps are unable to modulate their output power during low load conditions, which could lead to overheating of the fluid loop. In order to solve this problem, the buffer tank is required in between the load loop and the heat pump.

### **3. Modelling**

The system model is important for both the controller design, and for validation. The performance of a model based controller depends to a good part on the accuracy of the plant model. The nonlinear model of the whole system is implemented in Simulink, and a linearised plant model is used to formulate the optimisation problem [15, 16].

The building was modelled by considering wall layers as lumped components and considering each layer as a thermal resistor and a thermal capacitor. The tanks are modelled as heat stores with a known thermal capacity. The development of heat pump model was based on curve fitting to manufacturer's data.

#### **3.1. Building**

The building under consideration is a two room building; a hall and a bedroom. However the hot water and heating energy consumption is based on a typical house [17]. The hall has a south facing window. The dimensions of both the rooms are 4.27m\*4.57m and they are 2.44m high. The schematic layout of the building is shown in Figure 2.

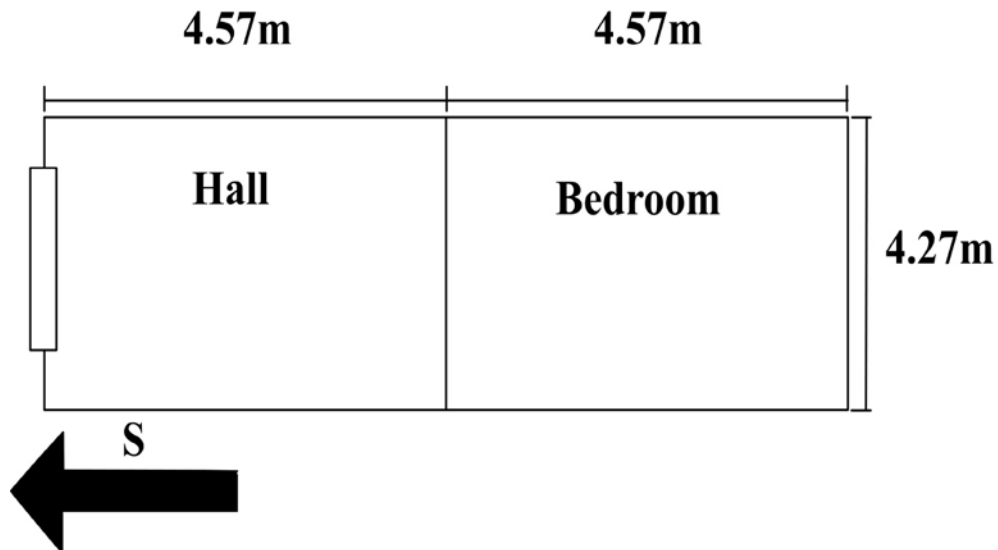

Figure 2: Building Layout.

A typical construction element consists of different layers of different materials. All the external walls and roof are considered of the same basic construction. The model used by Gustafson [18] is applied here. The building materials and properties of the external walls, roof and partition wall between hall and bedroom are summarised in Table 1.

Wall/Roof		Thickness in <i>m</i>	Thermal conductivity in $\frac{W}{Km}$	Density in $\frac{kg}{m^3}$
	Brick	0.1	0.84	1700
	Polystyrene	0.0795	0.034	35
	Concrete	0.1	0.51	1400
	Plaster	0.013	0.025	900
Partition Wall				
	Gypsum	0.025	0.25	900
	Air	0.1	$0.15 \frac{K m^2}{W}$ (Resistance)	1.204
	Gypsum	0.025	0.25	900

Table 1: Building Model Specifications.

The building construction is divided into number of layers and each layer is modelled separately. The advantage of this method is that it takes into account the time varying effect of heat moving from the inside to the outside of the building, and this is essential to model the correct response of the room air and radiation temperature to a change in heating. Solar gain was only considered in the hall area as it has the window. The fabric solar heat gain through the walls and roofs is considered as negligible because of the low thermal conductivity of the construction. Each layer of the construction is modelled separately in Simulink and considered as a single lump element. A wall with  $N$  layers can be seen in Figure 3.

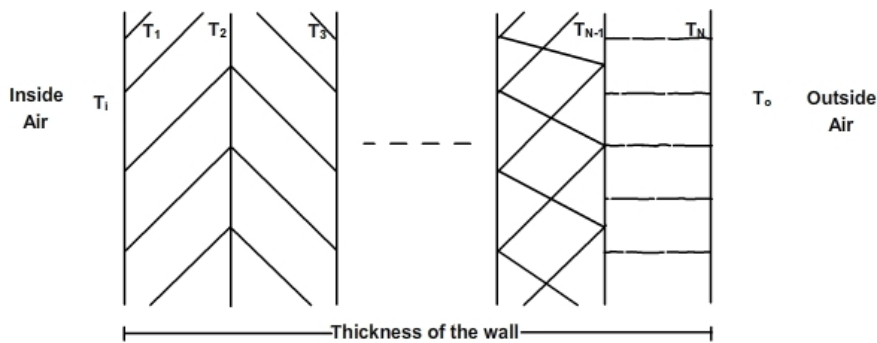

Figure 3: Wall Divisions.

The heat transferred from indoor air to the wall can be summarised in the following equation:

$$q_{conv} = q_{cond} + q_{stored} \quad (1)$$

$q_{stored}$  is the stored heat energy inside the wall layer or heat energy of lumped capacitance.

$$h_{in}(T_{in} - T_i) = \frac{k_i}{L_i} (T_i - T_{i+1}) + \frac{dT_i}{dt} (c_{p,i}\rho_i L_i) \quad (2)$$

$$\frac{dT_i}{dt} = \frac{h_i(T_{in} - T_i) - \frac{k_i}{L_i} (T_i - T_{i+1})}{c_{p,i}\rho_i L_i} \quad (3)$$



For middle layers the material also has capacitance and therefore heat storage capacity of the material is taken in to account. The heat balance equation is:

$$q_{con,1} = q_{cond,2} + q_{stored} \quad (4)$$

$$\frac{k_i}{L_i} (T_{i-1} - T_i) = \frac{k_{i+1}}{L_{i+1}} (T_i - T_{i+1}) + \frac{dT_i}{dt} (c_{p,i}\rho_i L_i + c_{p,i+1}\rho_{i+1} L_{i+1}) \quad (5)$$

where  $i = 2, 3, \dots, (N - 1)$

For outer layer the equation for heat energy is:

$$q_{conv,N} = q_{cond,N-1} + q_{stored} \quad (6)$$

$$h_{out}(T_i - T_{out}) = \frac{k_i}{L_i} (T_{i-1} - T_i) + \frac{dT_i}{dt} (c_{p,i}\rho_i L_i) \quad (7)$$

In the above equations it is assumed that the wall, roof and floor are divided into  $N$  layers with different properties and  $i=N$ .

### 3.2 Solar panel and water tanks

A flat plate collector is used to heat up the heating tank. The useful energy from the solar panel is calculated by using the following equation [19];

$$Q_U = F_R A_c [\tau \alpha I - U_L (T_c - T_a)] \quad (8)$$

The water tanks are modelled by assuming that the water inside the tanks mixes properly and there is no temperature stratification across the tank height. The second assumption is that the heat capacity of the tank is the heat capacity of the volume of the water inside the tank. The heat losses from the tanks are also considered and the losses from the buffer tank and the heating tank are added as the heat gain by the room air i.e. it is assumed that the tanks are placed in the bedroom. The hot water losses are added into the heat gain by the heat tank water.

### 3.3. Heat Pump

Several models for the heat pump Coefficient of Performance (COP) were tested. Initially an existing model developed from first principles was used [20], but this model did not give a good match when its COP results were compared with the data supplied by the manufacturer.

As a second step, the dynamics of the absorber and condenser were eliminated in favour of a quasi-stationary model. This leads to a model with only four remaining factors shown in Table 2.

$\alpha$	Thermal efficiency coefficient of compressor
$\beta$	Recovery share of losses into heat
$u_T P$	Thermal coefficient on condenser side
$u_E P$	Thermal coefficient on evaporator side

Table 2: Heat Pump Parameters

This leads to a quadratic equation for the effective COP:

$$(u_T + u_E)P * COP^2 + (T_T - T_E - u_E P - \beta(u_T + u_E)P - \alpha u_T P)COP - \alpha T_T - \beta(T_T - T_E - u_E P) = 0 \quad (9)$$

The above quadratic equation was then used to calculate the COP of the heat pump. Several methods were used to find the best fit to the existing data, but none of them provided a good match. It was found that plotting the inverse of the ideal COP vs the inverse of the actual COP provides a good fit. This plot was then approximated using a quadratic function:

$$y = 29.278x^2 - 4.8281x + 0.4328 \quad (10)$$

where x is the inverse of ideal COP and y is the inverse of actual (manufacturer's) COP.

It can be seen that the resulting curve gives better results than the previous methods. The plots of COP data from different methods are shown in Figure 4 and the inverse plot of both ideal COP and manufacturer's COP is shown in the Figure 5. The quadratic equation has an R<sup>2</sup> value of 0.9893, which is the coefficient of determination and is used to find out how accurate the equation will predict the future outcomes. In this case the value of R<sup>2</sup> is very close to 1 which means that the regression line fits the data very well. It can be concluded that this very simple model provides a

good match with the experimental data, and this cannot be said for the two previous models of the heat pump.

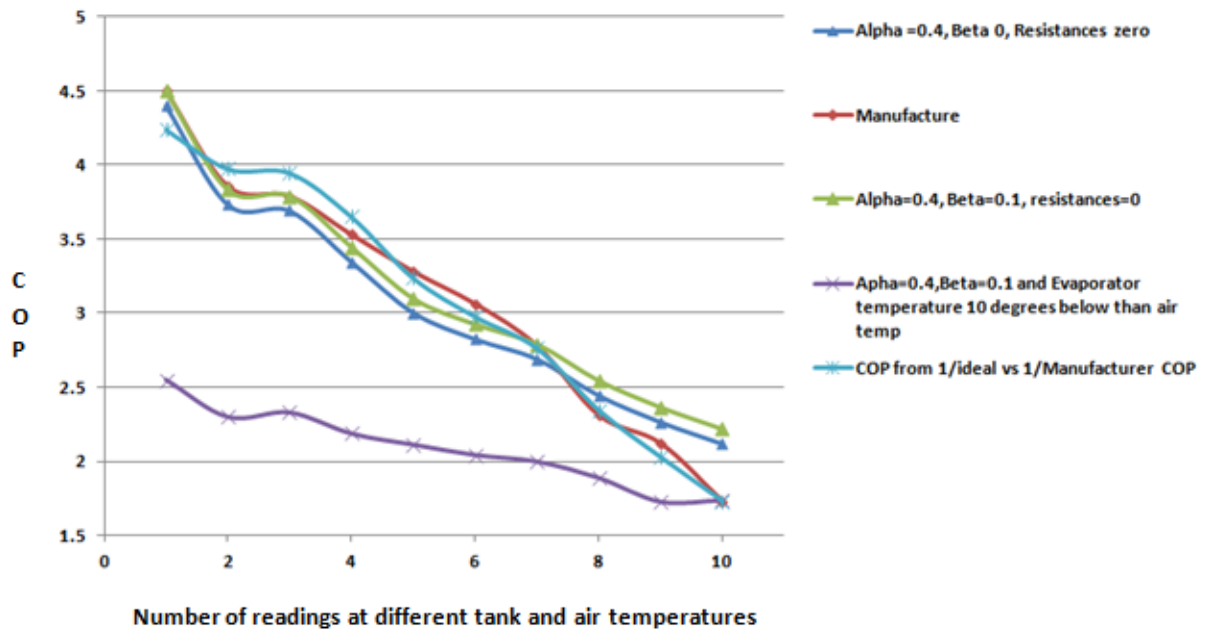

Figure 4: COP Plots from Different Methods.

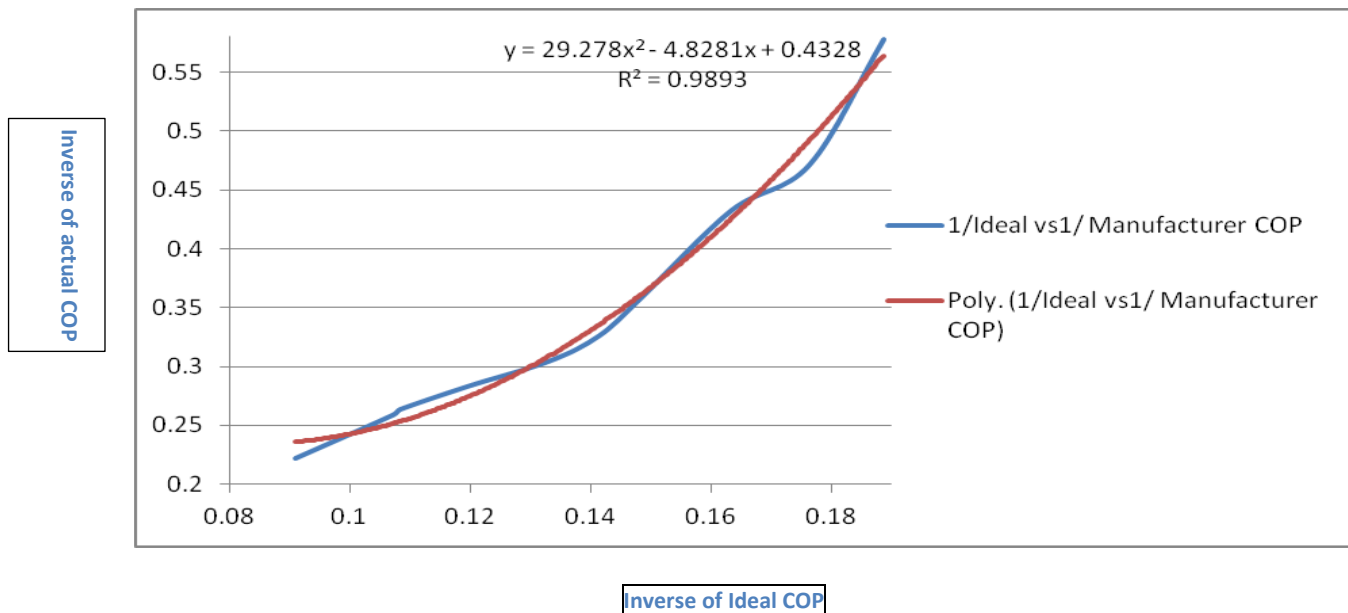

Figure 5: Inverse Plot of Ideal and Manufacturer COP

## 3.4. Controllers

Below is a brief overview and comparison of the On/Off and MPC strategies used that are used for the experimental heating systems.

### 3.4.1 On-off Controller

The on-off controller is the simplest type of controller. The controllable device e.g. heat pump in this case is turned on and off at certain thresholds. These are set according to a tank temperature error as given by

$$e_r = T_r - T_T \quad (11)$$

in which  $e_r$  is the error between reference temperature  $T_r$  and current tank temperature  $T_T$ . The controller output is turned on when the error  $e_r$  exceeds a positive threshold, and it remains on until  $e_r$  exceeds a negative threshold. The main advantage of the on-off controller is that it is simple and easy to implement. It is a feedback controller that does not contain any information about the plant dynamics.

### 3.4.2 Model predictive controller (MPC)

MPC is a class of computer algorithms that utilizes process models to predict future behaviour of a plant. The control signal is obtained by minimizing an objective function in real time [21]. The main difference in the various methods is the way the problem is translated into the mathematical model, and how this is solved numerically [22]. The main ideas behind predictive control methods are;

- Explicit use of a model to predict the process output at future time instant (horizon).
- Obtaining control signal by minimizing an objective function.
- Using a receding horizon strategy, where at each time step the horizon is moved to cover the same period into the future.

In MPC the model obtains data from past inputs and past outputs and combines this data with future inputs to create a prediction of future output values. The predicted outputs are compared with a reference trajectory to determine future output errors. These future errors are then used to calculate an objective function based on control inputs and output errors. The objective function is fed into optimizer, which tries to find a cost optimal solution while still satisfying constraints on the system. The optimiser returns the optimal inputs together with the predicted behaviour and cost. Due to the receding horizon approach, only the first input is implemented, and further steps are discarded in favour of an updated optimisation results based on the additional information available at the next time step.

The ability of an MPC controller to define and predict objective function makes this control strategy one of the most advance control strategies. The model predictive control makes use of the system model to obtain the control signal as a minimisation of the objective function. The aim of the objective function is to represent the compromise between fast and strong control action, which typically increases costs, and quick and accurate following of the reference trajectory. Therefore both input values and output errors are penalized. A typical objection function of model predictive control is defined by the following equation:

$$\begin{aligned}
 J(k) = & \sum_{i=1}^{n_y} w_{i+1}^y (y(k+i+1|k) - r(k+i+1|k))^2 \\
 & + \sum_{i=1}^{n_u} w_i^{\Delta u} (\Delta u(k+i|k))^2 \\
 & + \sum_{i=1}^{n_u} w_i^u (u(k+i|k) \\
 & - u_{target}(k+i|k))^2
 \end{aligned} \tag{12}$$

In the above equation,  $w_{i+1}^y$ ,  $w_i^{\Delta u}$  and  $w_i^u$  are non-negative weights of output, rate of change on input and input variables. The weights can be time varying, and this is used to represent changing

electricity prices according to a night time electricity tariff. In the multi-variable case, non-negative (symmetric) quadratic forms can be used as weights, although many implementations only support diagonal matrices. For the simulations, the prediction horizon is set to 24h, to cover a complete cycle of daily temperature and electricity cost variations.

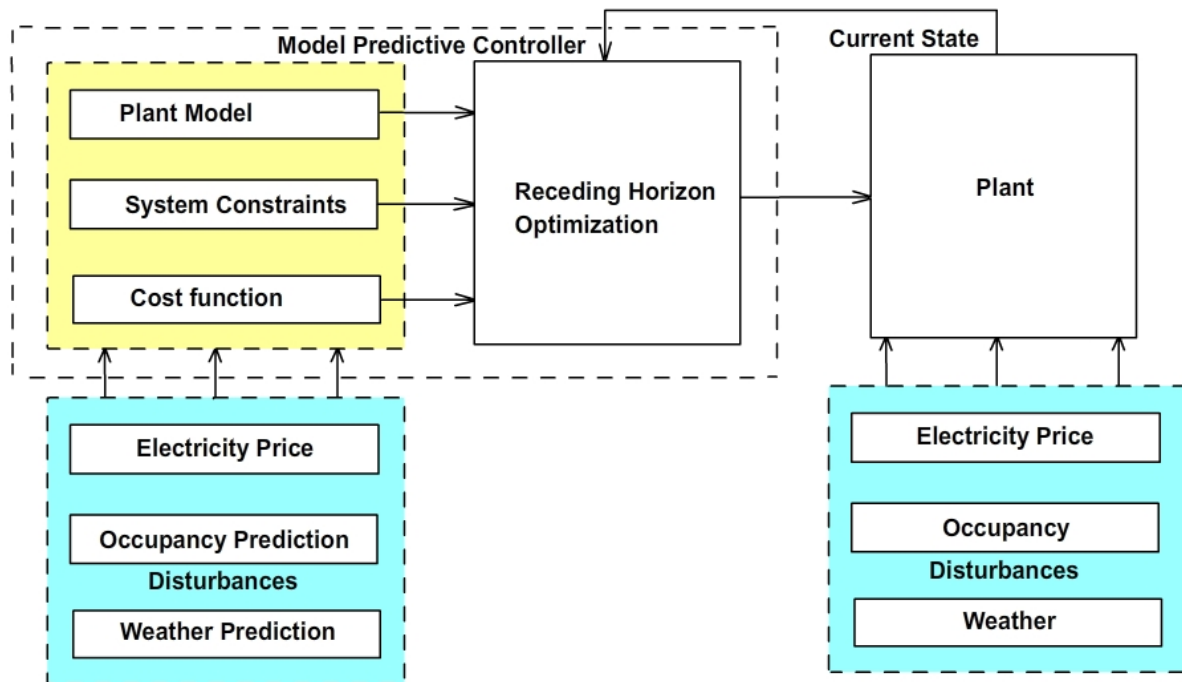

Figure 6: Model Predictive Controller Scheme

Figure 6 shows the basic control scheme used for the research. The energy price, occupancy prediction and weather prediction are the time varying external conditions. Together with the temperature measurements, these form the inputs to the controller. The plant model, system constraints, cost function and objective function are defined as the parts of the MPC controller. For every time step these parameters are combined and converted into an optimization problem, which then determines the output for the next time step.

Model predictive control has the ability to include constraints into the MPC formulation. MPC constraints can be physical limitations, or they can be used to constrain the operation of the system to most efficient condition. The constraints used in this paper are linear constraints that take the following form:

$$\begin{aligned}
u_{min,k} &\leq u_k \leq u_{max,k} \\
x_{min,k} &\leq x_k \leq x_{max,k}
\end{aligned}
\tag{13}$$

Linear constraints are most commonly used constraints. Only simple linear weights are used here in an attempt to keep the complexity of the optimization problem manageable.

## 4. Simulation results

To compare the effectiveness of the MPC controller to conventional on-off control scheme, two scenarios with London location are simulated. The water consumption data is based on existing data [17]. Night time electricity price is considered from midnight to 7 am in the morning.

The water consumption, solar radiations and outside environmental temperature are considered as disturbances that are known in advance. The electricity price and energy consumptions are also known in advance and are considered a time varying weight.

Simulations were performed by considering one cold day in the middle of two medium temperature days (Case A) and a sunny day in between of two days having medium solar radiations (Case B). The building was simulated using Integrated Environmental Solutions (IES) in order to obtain the total indoor heat gains.

### 4.1. Results: Case A

The results for Case A are shown in Figures 7 and 8. The initial air temperatures of both the bedroom and hall were 18°C and 22°C. The air temperatures dropped initially because the wall layers temperatures are initialised to 0°C, and they take time to heat up. The on-off controller (Figure 7) took 9 hours to bring the hall air temperature to a steady value whereas the MPC controller (Figure 8 ) took approximately 3 hours to bring the air temperature to the reference temperature of 22°C. Throughout the day with MPC better temperature control and thermal comfort in the building are also maintained.

The first objective of the control problem was to minimize the energy consumption by using night time electric tariffs, which are cheaper as compared to day time tariffs and also by using available solar energy. The model predictive controller uses more night time electricity while OnOff controller uses less night time electricity. From 24:00 to 31:00 (midnight to 7 am: day 2) MPC has used more energy than on-Off by taking advantage of cheaper tariffs. MPC then switched off the heat pump when it anticipated that day time electric tariffs are coming into action as can be seen in Figure 8. MPC also used a minimal amount of electricity to keep the tanks water temperature at desired level.

The on-off controller could not take electric tariffs into account and therefore uses more energy during the day time. After the initial settling period, the on-off controller keeps the temperatures between upper and lower limits, which lead to a typical limit cycle shown in Figure 7.

The second control objective was to do load shifting by using different control strategies. The model predictive controller does load shifting as can be seen in MPC control results, Figure 8. The MPC started storing heat energy during the night at 24:00 and raised the temperature in the buffer tank (T1) and hot water tank (T2) temperatures. The load shifting was stopped when the low electric tariffs were ended at 31h and 55h (7 am day 2 and 3) which resulted in heat pump being used at lower settings during the next days. The high heat pump signal at 57:00, shown in Figure 8, is resulted from the high water consumption at that time.



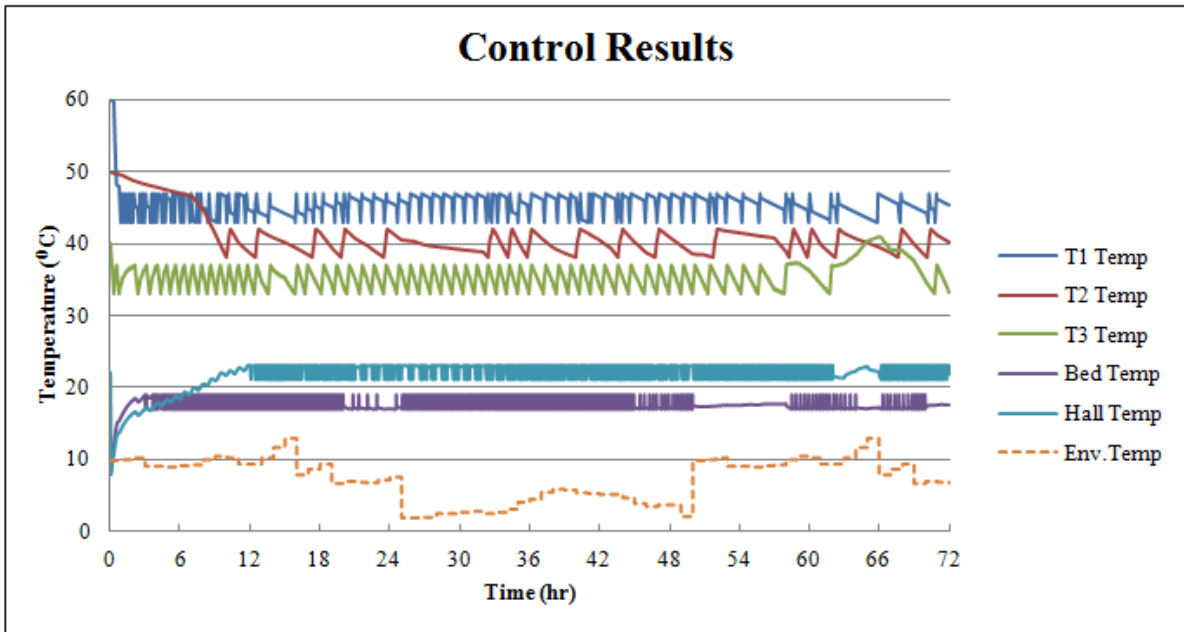

Figure 7: On-Off Control Results Case A

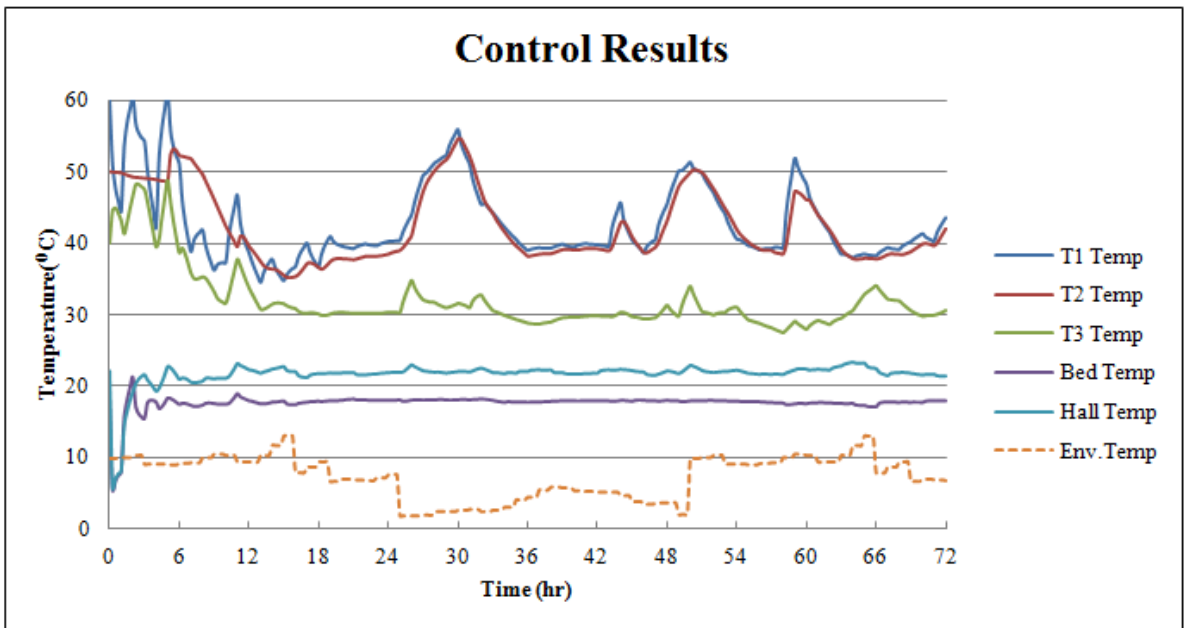

Figure 8: MPC Control Results Case A

The energy over time for Case A showed that the MPC achieves a lower electricity cost than the on-off controller. The MPC was able to switch off the heat pump at few points e.g. from 59:00 to 64:00h (11 a.m-4 p.m, day 3). The MPC used more energy at the beginning of the simulation because the room temperature became lower and controller used night time electricity. By using more

energy at the beginning MPC took less time to bring room air to a steady value than the on-off controller.

#### 4.2. Results: Case B

The second case simulations were performed by using one sunny day in the middle of two less sunny days. The results shown in Figures 9 and 10, demonstrated that both controllers were able to maintain the temperatures at desired level. The rise in heating tank temperature (T3) at 36:00h (12 p.m. day 2) is because of the strong solar radiation which has caused the temperature to exceed the reference temperature. Both controllers have used less energy compared to Case A, as the heating demand is less because of the sunny day.

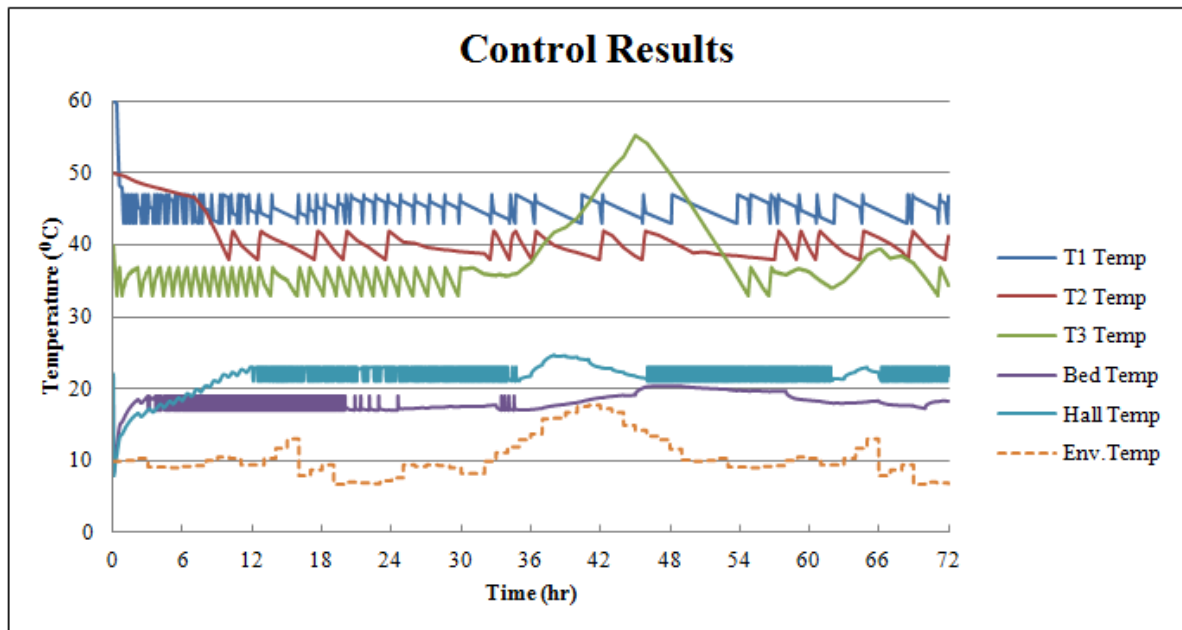

Figure 9: On-Off Control Results Case B

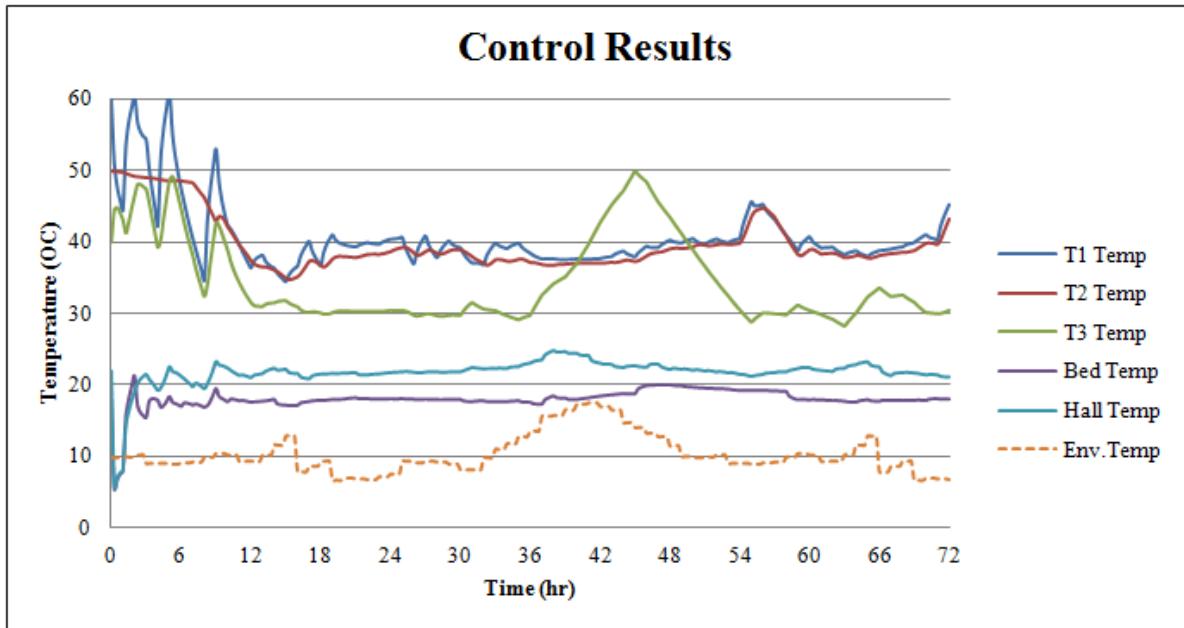

Figure 10: MPC Control Results Case B

The results for on-off controller Figure 9 shows that tank temperature's fluctuations are less than the room air temperature's fluctuations, due to higher temperature range for the tanks.

The MPC has used less energy during the second day and the energy used is only to heat up the hot water tank as the heat tank has enough energy because of the solar energy as shown in Figure 10.

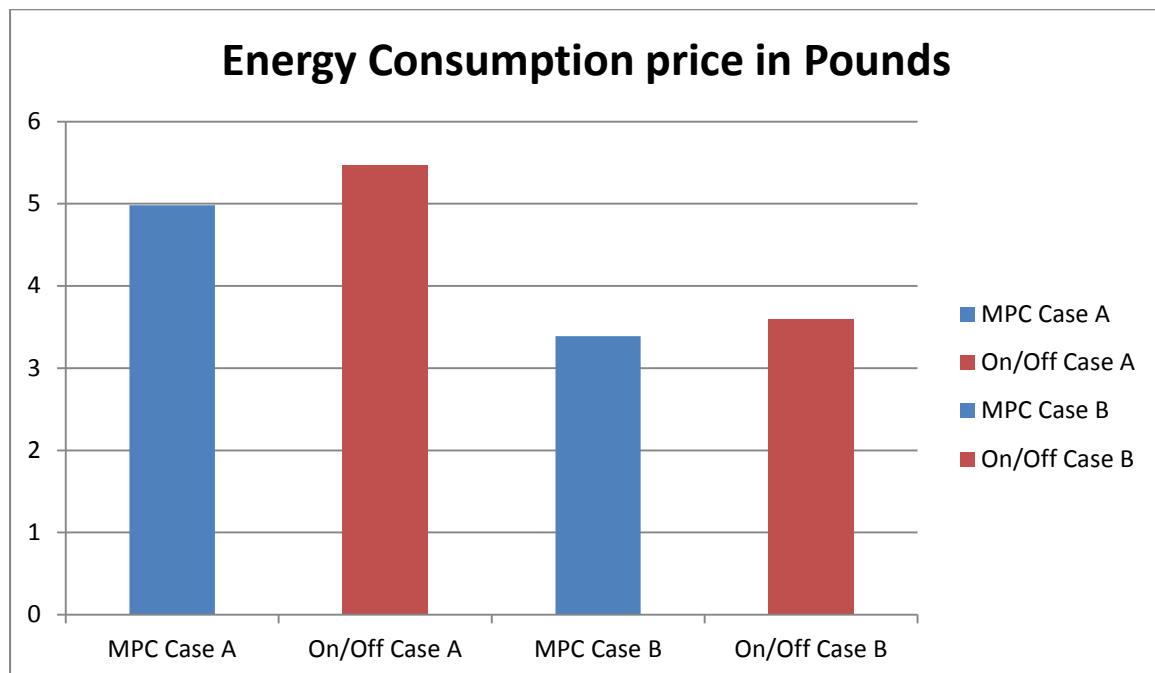

Figure 11: Energy Price in Pounds per day

The simulation results shown in Figure 11 demonstrated that the MPC saved about 9% of the energy cost. This is mainly due to the fact that model predictive controller used cheaper night time electricity and heat pump was used at low settings or even was turned off during the day time.

The on-off strategy is the easiest to apply, as it does not require any tuning and requires essentially no computation. The MPC controller on the other hand has a number of requirements: it needs a plant model, selected weights, and it also needs measurements and predictions of external parameters.

## 5. Conclusions

Overall the model predictive controller proved to have a greater potential in the area of load shifting and use of renewable energy. The simulation results showed that the MPC consumed less energy than the on-off controller. The model predictive controller also used cheaper night time electricity and the heat pump was used at low settings or even was turned off during the day time. The room temperatures maintained at the desired level and the set points achieved very quickly. Overall the MPC controller maintained good thermal comfort in the building.

One of the main limitations of MPC was found to be the use of linear model requirement which did not match the heat transfer between the tanks. The error increases as the tank temperature deviate from the nominal values used for linearization, and the effect on temperature stability is exacerbated by the long cycle time of the MPC controller. It may be possible to reduce this issue by using energy transfer rate rather than mass flow rate as a control input. Alternatively, an underlying control structure with faster response time could limit the effect on room temperatures.

The second limitation was that the MPC controller could not optimise secondary (non-linear) effects, because they are not contained in the model. The most important one is the change in effectiveness of the heat pump (COP) due to changes in the tank temperature. Therefore, the controller does not try to keep the tank temperature low unless this goal is explicitly included in the cost function.

In general, the system is most suitable for residential market and the results highlight the importance of advanced controls for combined solar and heat pump systems in order for the system to operate efficiently and maintain good thermal comfort in the building. The MPC controller demonstrated to maintain better thermal comfort and less temperature fluctuation.

### Acknowledgement

This research is funded by EPSRC UK under the title of "Sandpit-integration of active and passive indoor thermal environment control systems to minimise the carbon footprint of airport buildings".

### References

- [1] International-Energy-Agency. *Key world Energy Statistics*. 2006.
- [2] <http://www.decc.gov.uk/assets/decc/11/stats/publications/energy-consumption/2323-domestic-energy-consumption-factsheet.pdf>, accessed November 2012
- [3] B.J.Huang , J.P.Lee, J.P. Chyng, Heatin-pipe enhanced solar-assisted heat pump water heater, *Solar Energy* 78 (2005) 375-81.
- [4] M.N.A.Hawladar, S.K. Chou, M.Z. Ullah, The performance of a solar assisted heat pump water heating system, *Applied Thermal Engineering* (2001) 1049-65.
- [5] A. Nutaphan, C. Chasena, T. Kiatsiriroat, Performance analysis of solar water heater combined with heat pump using refrigerant mixture, *Applied Energy* 86 (2009) 748-756.
- [6] <http://www.opticontrol.ethz.ch/>, accessed October 2012.
- [7] M.Yudong, F.Borrelli, B.Hencey, A.Packard, S.Bortoff, *Model Predictive Control of thermal energy storage in building cooling systems*, in: *Proceedings of the 48th IEEE Conference on Decision and Control*, held jointly with the 28th Chinese Control Conference, 2009, pp. 392-397, doi:10.1109/cdc.2009.5400677.
- [8] M.Yudong, F.Borrelli, B.Hencey, B.Coffey, S.Bengea, P.Haves, *Model predictive control for the operation of building cooling systems*, in: *American control conference (ACC)*, 2010, pp. 5106-5111, ISSN 0743-1619.
- [9] F. Oldewurtel, A. Ulbig, A. Parisio, G. Andersson, M. Morari, Reducing peak electricity demand in building climate control using real-time pricing and model predictive control, in: *Conference on Decision and Control, CDC*, 2010.
- [10] W. Grunenfelder, J. Todtli, The use of weather predictions and dynamic programming in the control of solar domestic hot water systems, in: *Proceedings of Mediterranean Electrotechnical Conference (Melecon)*, Madrid, Spain, 1985.
- [11]. G. Henze, C. Felsmaan, G. Knabe, Evaluation of optimal control for active and passive building thermal storage, *International Journal of Thermal Sciences* 43 (2004) 173–183..
- [12] G. Henze, C. Felsmaan, G. Knabe, Impact of forecasting accuracy on predictive optimal control of active and passive building thermal storage inventory, *International Journal of HVAC and Research* 10 (2004) 153–178.
- [13] G. Henze, D. Kalz, S. Liu, C. Felsmaan, Experimental analysis of model based predictive optimal control for active and passive building thermal storage inventory, *International Journal of HVAC and Research* 11 (2005) 189–214.

- [14] J. Široký, F. Oldewurtel, J. Cigler, S. Privara, Experimental analysis of model predictive control for an energy efficient building heating system, *Applied Energy* 88 (9) (2011) 3079–3087.
- [15] E.F. Camacho, C. Bordons, *Model Predictive Control*, Springer-Verlag, London, 1999.
- [16] J. Maciejowski, *Predictive Control with Constraints*, Prentice-Hall, 2001.
- [17] Defra, *Measurement of domestic hot water consumption in dwellings*, Copyright Crown, 2008.
- [18] J. Gustafsson, J. Delsing, J. van Deventer, Thermodynamic Simulation of a Detached House with District Heating Subcentral, in: *Systems Conference, 2<sup>nd</sup> Annual IEEE*, 2008, pp. 1 – 8.
- [19] J. Duffie, W. Beckman, *Solar Engineering of Thermal Processes*, Wiley, New York, 1991.
- [20] A.W.M. Van Schijndel, M.H. De Wit, in: *Proceedings of 8th International IBPSA Conference*, Eindhoven, Netherlands, *Advanced simulation of building systems and control with simulink* (2003) 1185 – 1192.
- [21] S.J. Qin, T.A. Badgwell, A survey of industrial model predictive control technology, *Control Engineering Practice* 11 (7) (2003) 733 – 764.
- [22] T.J.J. Van Den Boom, A.A. Stroorvogel, *Model Predictive control*, DISC Course, Lecture Notes, 2010.