

MANUFACTURING MONODISPERSED DROPS AND ADVANCED MICRO/NANO- PARTICLES USING MICROFLUIDICS

Goran T. Vladislavljević

Microfluidic Group Leader, Chemical Engineering Department, Loughborough University, LE11
3TU, United Kingdom. Email: G.Vladislavljevic@lboro.ac.uk

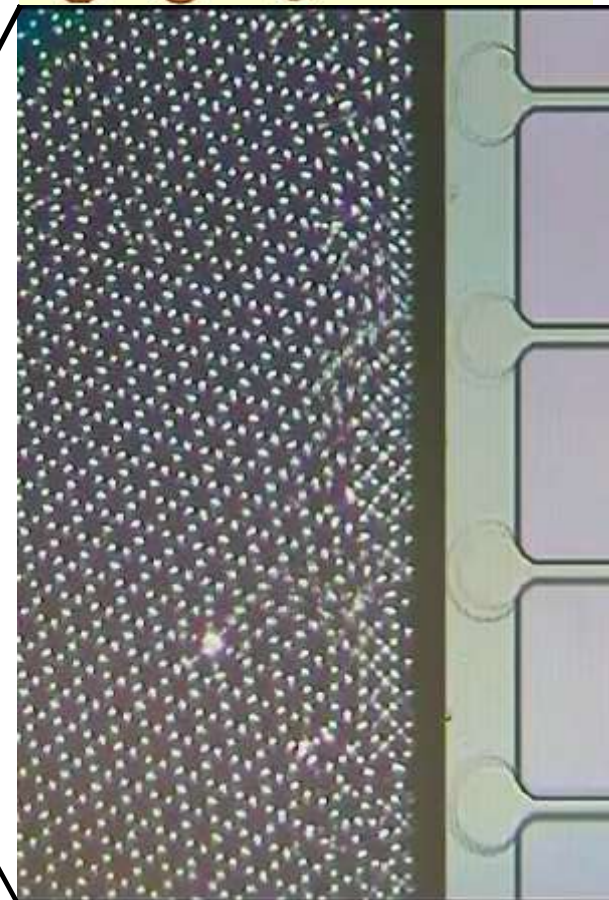

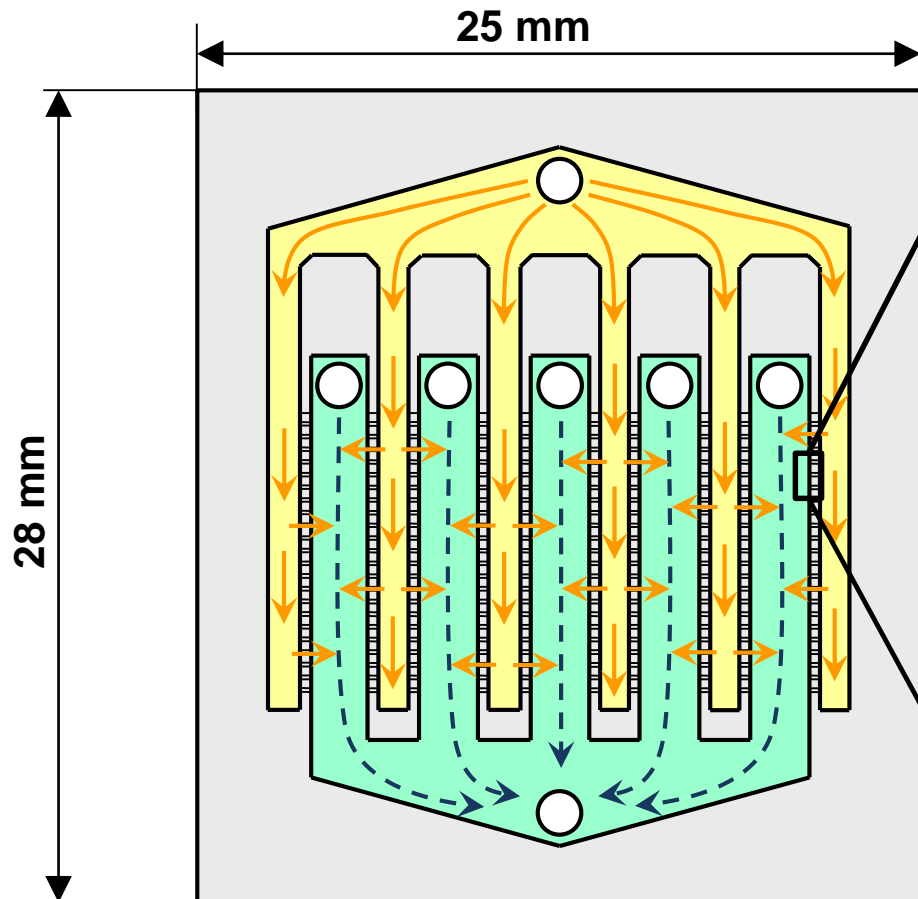
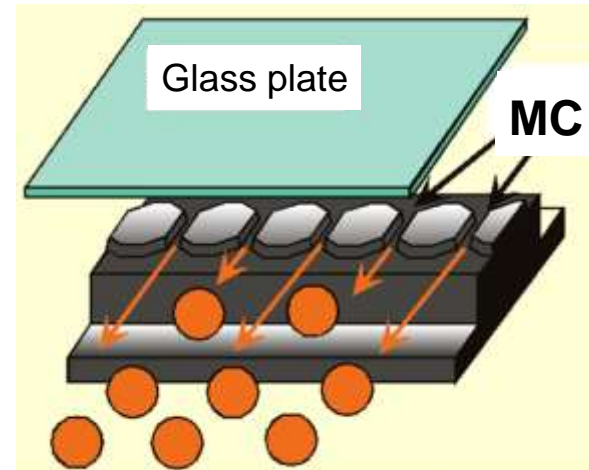
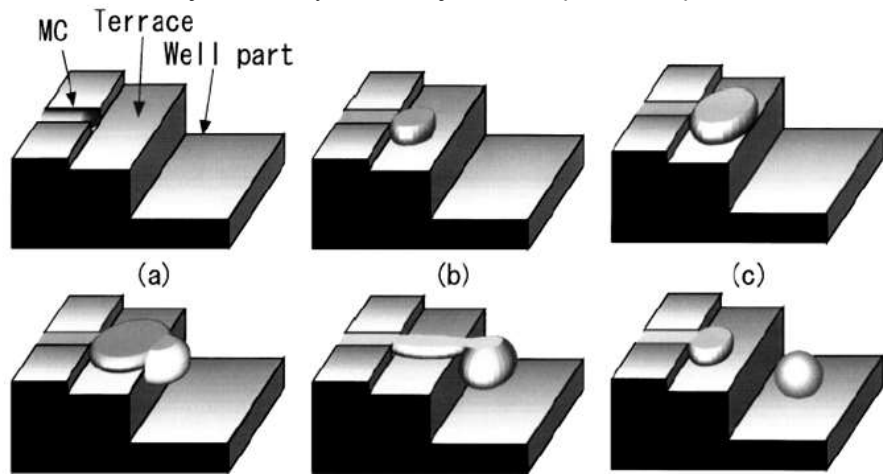

Membrane emulsification

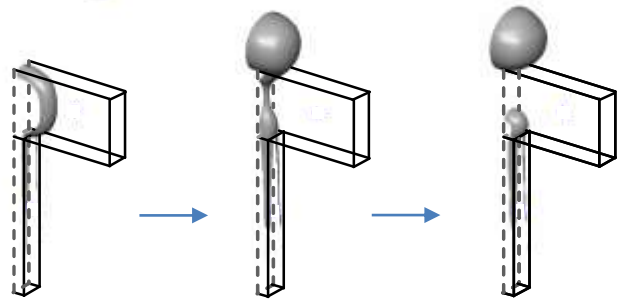
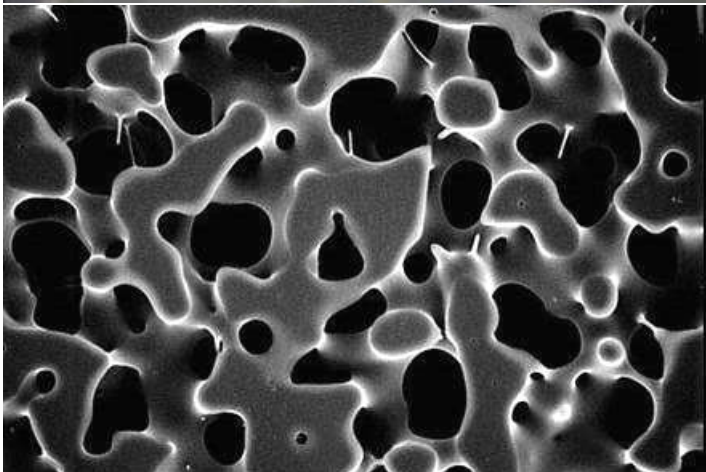
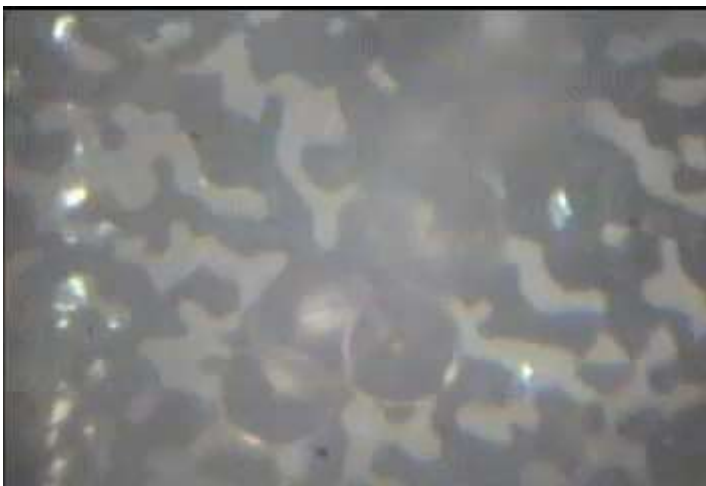

Kobayashi I, Vladislavljević GT, Uemura K, Nakajima M, *Chem. Eng. Sci.*, 2011

Silicon straight-through microchannel plates

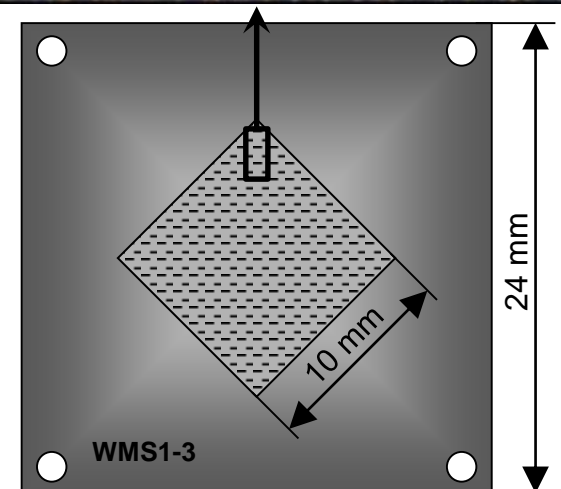
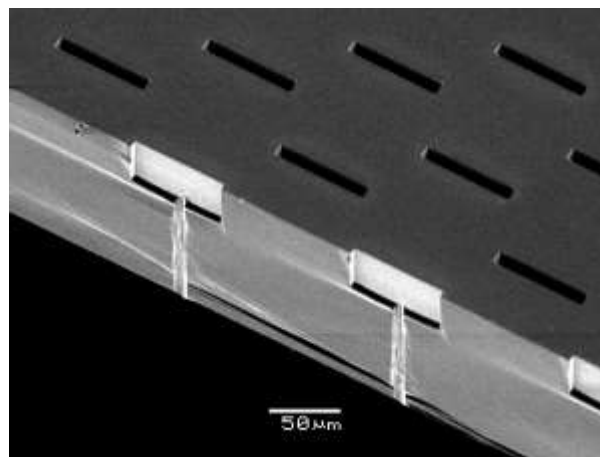

Eudragit microbeads

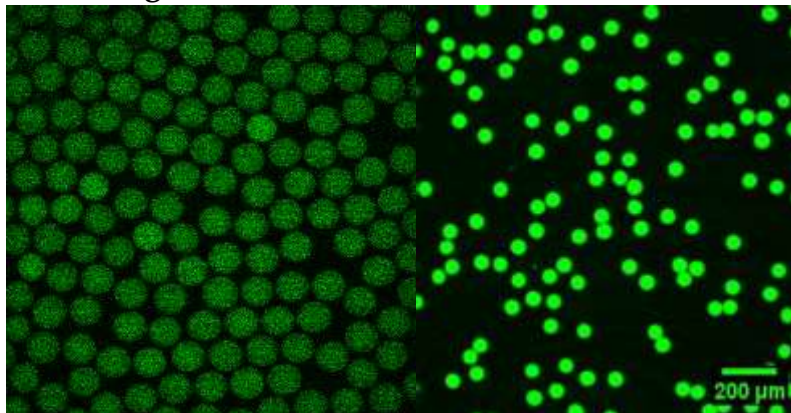

pH-sensitive PLA capsules loaded with Eudragit solution

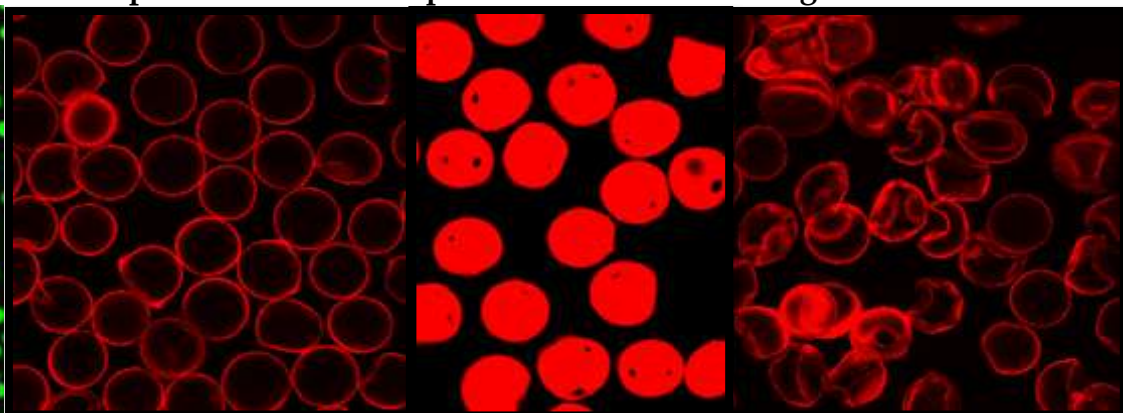

Vinner GK, Vladislavljević GT, Clokie MRJ, Malik, DJ, *PLoS One*, 2017

Ekanem, Zhang, Vladislavljević, *J. Colloid Interface Sci.* 2017

Janus particles

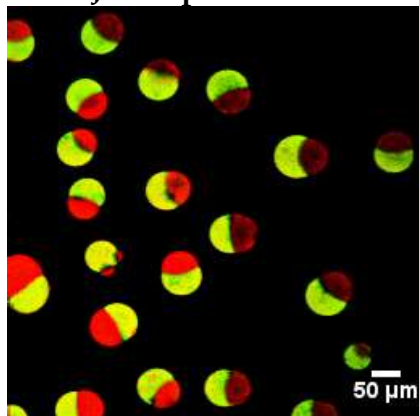

Patchy particles

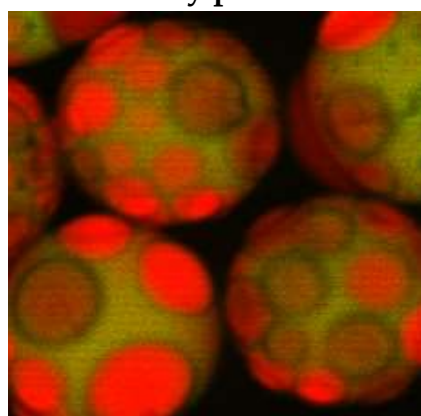

Crescent particles

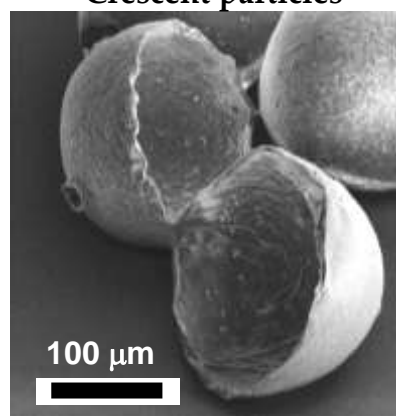

pH-sensitive capsules for CO₂ sensing

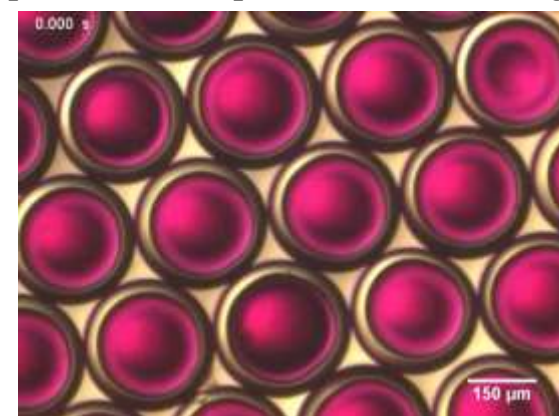

Ekanem, Zhang, Vladislavljević, *Langmuir*, 2017; Ekanem, Zhang, Vladislavljević, *J. Colloid Interface Sci.* 2017

Nabavi, Vladislavljević, Gu, Manović, *Langmuir*, 2016

Electrospun nanofibres

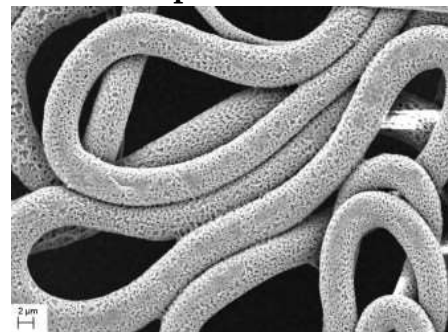

Chitosan microbeads

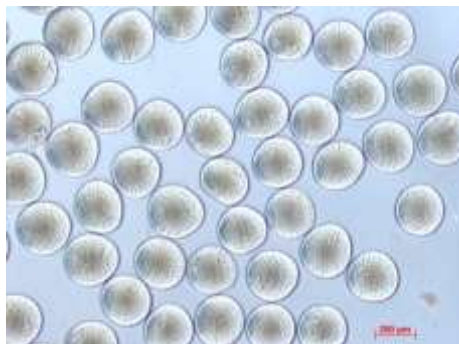

Hemispherical particles

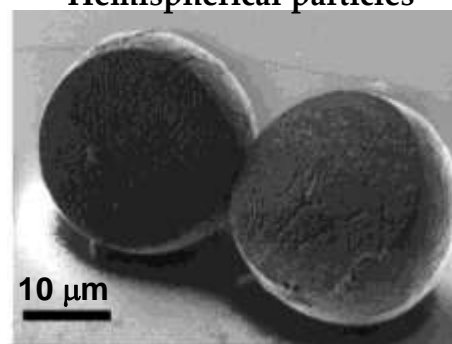

Golf ball-like particles

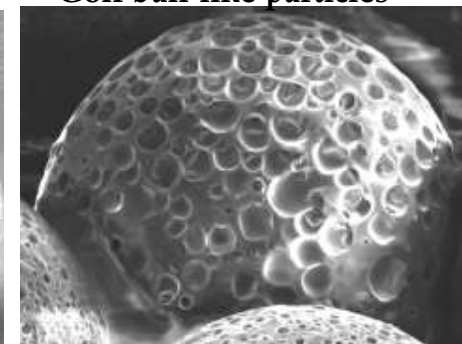

Katsogiannis, KA. Vladislavljević, GT, Georgiadou S, *European Polymer J*, 2015

Mark et al., *J. Colloid Interface Sci.*, 2009

Ekanem, EE, Nabavi SA, Vladislavljević GT, Gu S, *ACS Appl. Mater. Interf.*, 2015

COMPOSITE POLYMER/NANOCLAY NANOPARTICLES

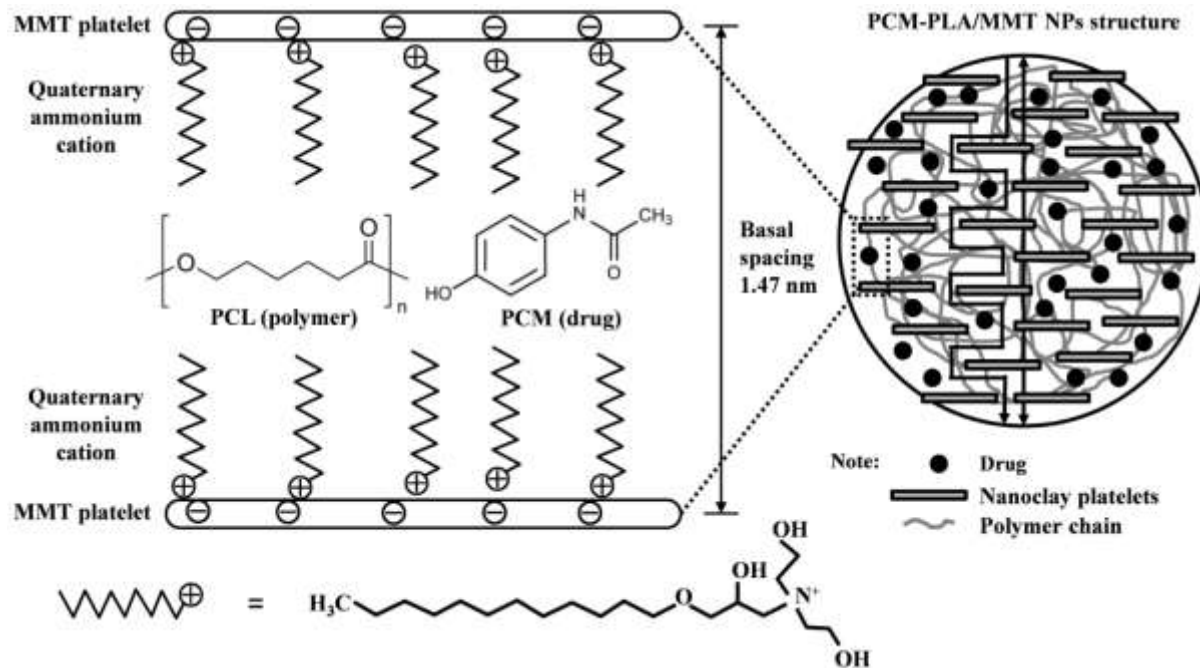

Othman R, Vladislavljević GT, Thomas N, Nagy Z, *Colloids and Surfaces B*, 2016

GROWN CRYSTALS

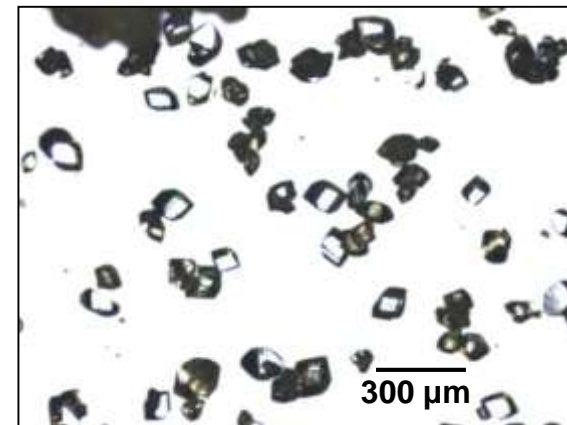

CRYSTAL SEEDS (BY GRINDING)

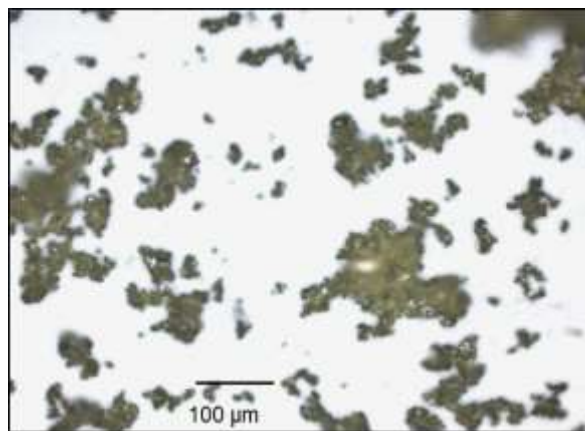

CRYSTAL SEEDS (BY MEMBRANE CRYSTALLISATION)

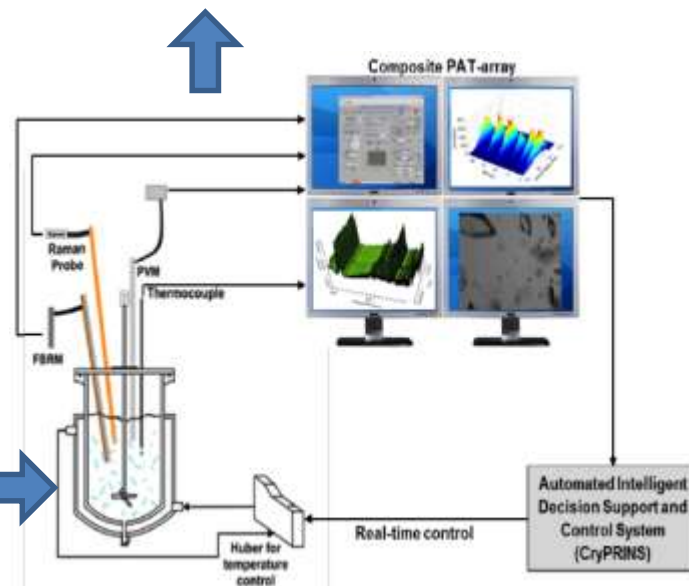
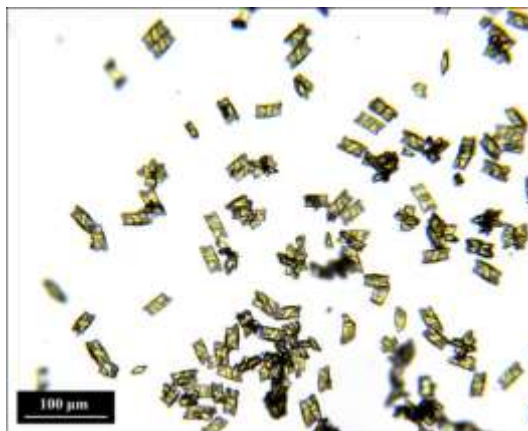

MICROFLUIDIC EMULSIFICATION

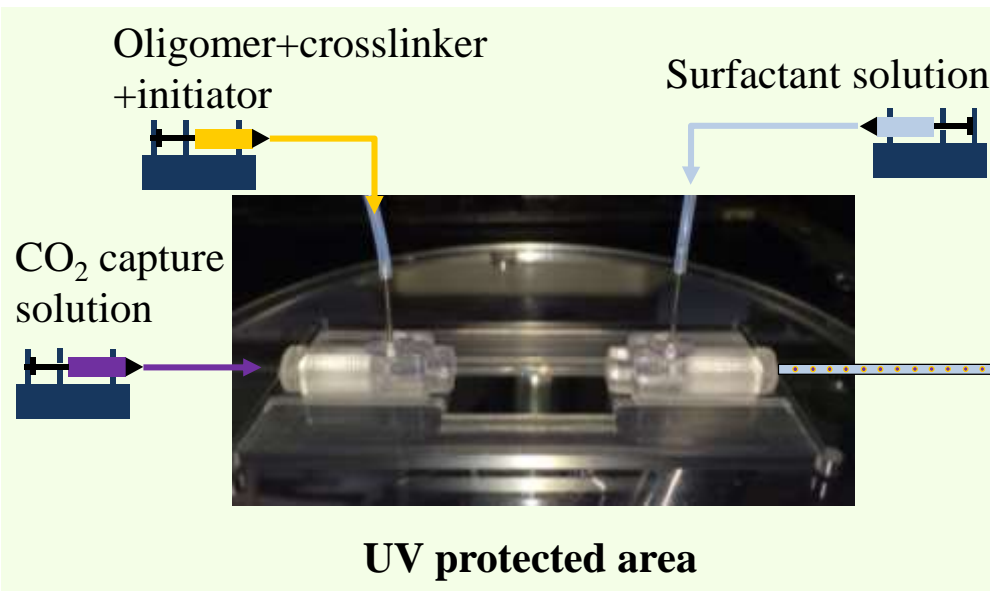

„ON-THE-FLY“ PHOTOPOLYMERISATION

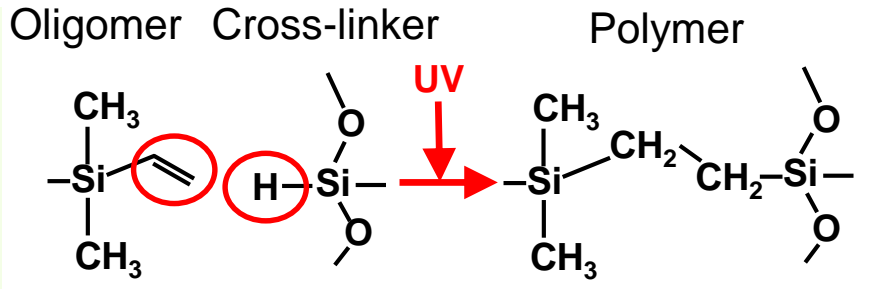

Osmotic swelling

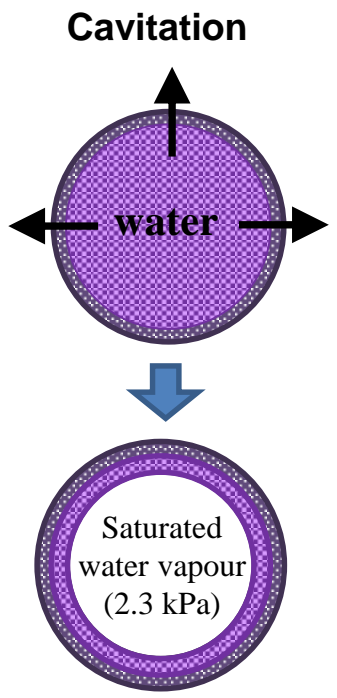
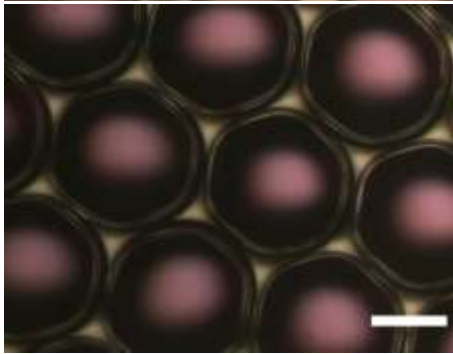
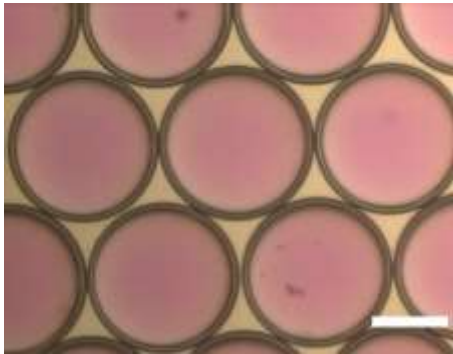
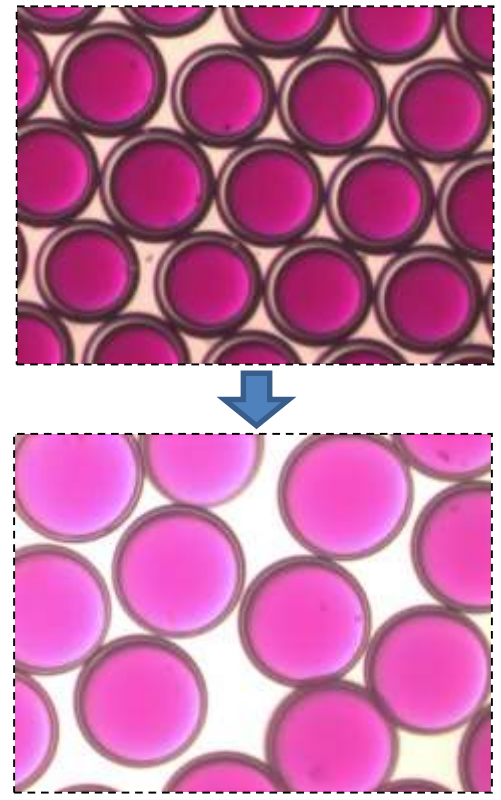

RESEARCH FUNDING

- ❖ UK-JSPS BRIDGE FELLOWSHIP
- ❖ ENGINEERING AND PHYSICAL SCIENCES RESEARCH COUNCIL
- ❖ ROYAL ACADEMY OF ENGINEERING, LONDON
- ❖ JAPAN SOCIETY FOR THE PROMOTION OF SCIENCE INVITATION FELLOWSHIP
- ❖ FULBRIGHT AGENCY, WASHINGTON
- ❖ ROYAL SOCIETY, LONDON
- ❖ JAPAN SOCIETY FOR THE PROMOTION OF SCIENCE POSTDOCTORAL FELLOWSHIP
- ❖ ALEXANDER VON HUMBOLDT FOUNDATION BONN



EPSRC

Engineering and Physical Sciences
Research Council



Invitation Fellowship Programs
for Research in Japan

FULBRIGHT



THE ROYAL SOCIETY



JSPS

