This item was submitted to [Loughborough's Research Repository](#) by the author.
Items in Figshare are protected by copyright, with all rights reserved, unless otherwise indicated.

The effect of pleat count and air velocity on the initial pressure drop and fractional efficiency of HEPA filters

PLEASE CITE THE PUBLISHED VERSION

PUBLISHER

Filtech Exhibitions

VERSION

AM (Accepted Manuscript)

LICENCE

CC BY-NC-ND 4.0

REPOSITORY RECORD

Al-Attar, I.S., Richard J. Wakeman, E.S. Tarleton, and A. Husain. 2009. "The Effect of Pleat Count and Air Velocity on the Initial Pressure Drop and Fractional Efficiency of HEPA Filters". figshare. <https://hdl.handle.net/2134/5621>.

This item was submitted to Loughborough's Institutional Repository (<https://dspace.lboro.ac.uk/>) by the author and is made available under the following Creative Commons Licence conditions.



CC creative commons
COMMONS DEED

Attribution-NonCommercial-NoDerivs 2.5

You are free:

- to copy, distribute, display, and perform the work

Under the following conditions:

BY: **Attribution.** You must attribute the work in the manner specified by the author or licensor.

Noncommercial. You may not use this work for commercial purposes.

No Derivative Works. You may not alter, transform, or build upon this work.

- For any reuse or distribution, you must make clear to others the license terms of this work.
- Any of these conditions can be waived if you get permission from the copyright holder.

Your fair use and other rights are in no way affected by the above.

This is a human-readable summary of the [Legal Code \(the full license\)](#).

[Disclaimer](#) 

For the full text of this licence, please go to:
<http://creativecommons.org/licenses/by-nc-nd/2.5/>

THE EFFECT OF PLEAT COUNT AND AIR VELOCITY ON THE INITIAL PRESSURE DROP AND FRACTIONAL EFFICIENCY OF HEPA FILTERS

I.S. Al-Attar¹, R.J. Wakeman^{1,2}, E.S. Tarleton¹ (e.s.tarleton@lboro.ac.uk) and A. Husain³

¹Department of Chemical Engineering, Loughborough University, Loughborough, LE11 3TU, UK.

²Consultant Chemical Engineer, Clyst St Mary, Exeter, EX5 1DD, UK.

³Kuwait Institute for Scientific Research, Department of Building and Energy Technologies, P.O. Box 24885, Safat, Kuwait, 305-343, Kuwait.

ABSTRACT

The importance of clean air to the well-being of people and industrial applications has highlighted the critical role of air filters performance. Accurate filter performance prediction is important to estimate filter lifetime and reduce energy and maintenance operating costs. To ensure appropriate filter selection for a specific application, the effect of pleat count and surface area on filter design and performance has been investigated. This paper examines the effects of air velocity on permeability during operation of HEPA pleated V-shaped filters, and the effect of pleat count on the initial pressure drop and fractional efficiency using DEHS testing according to DIN 1822. An empirical equation for predicting the efficiency of the filter is suggested.

KEYWORDS

Air filters; Fractional efficiency; Gas cleaning; Glass fibre; HEPA filter; Permeability; Pressure drop.

INTRODUCTION

Air filters are expected to separate and retain particles on or within the internal structure of a filter medium to remove aerosol particles from air at different efficiencies with the least possible resistance. High Efficiency Particulate Air (HEPA) filters are made from fibrous media. They are widely used in applications such as operating theatres, the pharmaceutical industries, gas turbines, space stations, clean rooms, and semi-conductor industries, amongst many other. HEPA filters are required to remove particles from the gas stream with very high efficiencies at the least possible pressure drop. Removal efficiency and pressure drop are therefore the main filtration performance characteristics.

Although several authors have studied the performance of clean filters [1-3], but the literature on the clean HEPA pleated filter is quite limited [4-6]. This paper investigates the effect of pleat count, surface area, and filter medium permeability on filter design and performance in terms of initial fractional efficiency and pressure drop.

FILTER PROPERTIES

The experimental work involved the testing of glass fibre pleated cartridges of HEPA Class H10 according to DIN 1822 [7]. Eight filters were manufactured by EMW Filbertechnik with pleating densities varying from 28 to 34 pleats per 100 mm. Table 1 lists all filters used for testing with their corresponding surface areas. The manufactured filters were divided into two groups, A and B. Both groups underwent similar testing procedures and were challenged with DEHS to give data for the

initial fractional efficiency. Figure 1 shows the face dimensions of 592 x 592 mm with a depth of 400 mm. The filter cassette has a V-shape bank which contains eight pleated media panels.

The glass fibre media used in these filters is shown in Figure 2. Glass fibre filtration media was selected for all experiments in this work as it exhibits better resistance to high temperatures and has smaller fibre size compared to synthetic media. Glass fibre media are highly porous with a low resistance to air flow. The filter's performance is affected by several variables such as filter medium thickness, permeability, packing density, fibre diameter as well as the design of the filter module. Operating conditions such as filtration velocity and temperature also affect the filter's performance, in addition to the characteristics of the aerosol such as particle size distribution, particle shape and density. The properties of the media are listed in Table 2.

PLEATED MODULE PROPERTIES

Pleating the filter medium provides larger surface area in a given space, which increases particle loading capacity per unit area when compared with a flat sheet medium. Pleated medium panels are more stable than a flat sheet of the same medium, which is inclined to deform and eventually rupture. Another major advantage of increasing the surface area is to decrease the air approach velocity to the medium, which translates into an increase in the aerosol's residence time inside the medium. This increases the probability of the particle-fibre contact and leads to an enhancement of diffusional capture efficiency. However, an excessive number of pleats or overpleating in given area in an air filter cartridge may also lead failure by rupturing the filter medium. Consequently, the pleating density has to be optimized to provide the desired efficiency at the least possible pressure drop. Four different pleating densities were chosen for that purpose in this work.

Previous studies have highlighted the optimal pleat count. Chen *et al.* [5] developed a numerical finite element model to optimize the design of the pleats of filter materials with different permeabilities. Their results show that for a given pleat height, the optimal pleat density increases as the filter media permeability decreases. Currently, filter manufacturers have the same pleat density for all filter classes. This may signify ineffective use of the media since less pleat density is needed with lower filter classes. On the other hand, optimal pleat density has also to be considered from an efficiency point of view. For example, a pleat count might be optimal from a pressure drop standpoint but it may not be able to achieve the desired efficiency. Therefore, optimal pleat density should be addressed in conjunction with efficiency.

CLEAN GAS PERMEATION

The passage of the clean gas through the filtration was enabled the pressure drop and efficiency to be measured, whilst challenging the filter with DEHS according to DIN 1822. There is no dust loading at this stage of the testing. The Reynolds number is used to verify the flow regime in the testing tunnel and through the filter medium. The Reynolds numbers for the filter medium (using the fibre diameter) at the flow rates of 500 and 5000 m³/h are 0.00122 and 0.0122 respectively. Therefore, the flow inside the filter medium is laminar. The Reynolds numbers in the rectangular feed duct to the filter (with a hydraulic diameter of 610 mm) at flow rates of 500 and 5000 m³/h are 14,476 and 144,760 respectively. Therefore, the flow inside the duct is turbulent.

The flow inside the filter medium can be interpreted using Darcy's Law to calculate the permeability, k :

$$k = \frac{\mu V h}{\Delta p}$$

where μ is the air viscosity, V the approach velocity of the air, h the filter medium thickness, and Δp the pressure drop across the medium. The initial pressure drop was measured and is shown in Table 3 at different flow rates ranging from 500 to 5000 m³/h at increments of 500 m³/h, together with the corresponding permeability values. A sample of the data is plotted in Figure 3 to show the non-linear variation of pressure drop with flow rate, and the typical variation of permeability with approach velocity is shown in Figure 4.

Table 3 lists the permeabilities for all corresponding pressure drops and face velocities. It can be seen that as the flow rate (and face velocity) increases, the permeability decreases (Figure 4). As the pleat density increases, permeability is reduced. For both filter groups A and B, permeability remained the same as the pleating density increased from 30 to 32 pleats/100 mm. Figure 4 shows that filters 30B and 32B have the same permeability for different face velocities. Filter 30A exhibited higher pressure drop response than 28A and 28B with surface areas 23.9 and 24.6 m², and consequently its permeability was reduced. As the pleating density increased from 26.6 to 27.3 m² for filters 30B to 32B, the latter exhibited lower pressure drop and higher permeability.

The permeability change is due to losses in surface area in the filtration medium or to compression of the medium. The Darcy model indicates a linear variation of pressure drop with flow rate and is only valid when there is no compression of the filtration medium. For a pleat there can be a loss of media surface due to pleat crowding and/or expansion of pleats. Media distortion at the crease of the pleat also influences the filter surface area losses; the effect of compression at the inner surface and expansion at the outer surface of the crease is shown in Figure 5. The higher the number of pleats, the more geometrical deformation is expected to take place. Therefore, additional permeability reduction is expected in higher pleating densities such with 32 and 34 pleats/100 mm. An additional deformation or buckling is expected to take place in the overall pleated panel which would also lead to loss of surface area and reduction in permeability. This sort of bulking could also lead to the fracture of the pleated panel during operation.

INITIAL EFFICIENCY MEASUREMENT USING DEHS

The initial efficiencies were measured for all filters for flow rates using a PMT LPS particle counter with a size range of 0.065 to 0.9 μ m. In these experiments the flow rates were varied from 500 to 3000 m³/h in 500 m³/h increments. These measurements are of critical importance to determine the MPPS (Mean Penetrating Particle Size) for each flow rate, and hence to define the filter class. Figure 6 illustrates the initial efficiency measurements for filter 28B.

MODELS APPLIED TO DEHS EFFICIENCIES

The efficiency models listed in Table 4 were fitted to the experimental data. It was found that the Lee and Lui [8] model showed the same trends as the experimental data and it was therefore chosen for further study as a possible engineering model to describe the initial efficiency of the pleated HEPA filters.

The Lee and Liu model was rewritten as:

$$\eta = \beta_1 \left(\frac{1-\alpha}{Ku} \right)^{\frac{1}{3}} Pe^{-\frac{2}{3}} + \beta_2 \left(\frac{1-\alpha}{Ku} \right)^{\frac{1}{3}} \frac{R^2}{1+R}$$

where β_1 and β_2 are constants to be derived from the experimental data. Table 5 lists the β_1 and β_2 values for filter group A at various flow rates. In addition, Figure 7 shows a good agreement between the efficiency experimental results and theoretical model of Lee and Liu for flow rates from 500 to 3000 m³/h respectively. It can be concluded that interception for all tested filters is independent of flow rate and number of pleats. On the other hand, diffusion contribution to the efficiency becomes more dominant as the flow rate increases and the pleating density decreases.

CONCLUSIONS

- Air filter permeability decreases with the increase of pleating density which is in agreement with a previous numerical study [5].
- The MPPS particle size decreases with the increase of filter's face velocity for all pleating densities a given surface area and filter medium. The MPPS increases slightly or remains constant as the pleating density increases.
- Filter Class H10 efficiency requirements according to Standard DIN 1822 were achieved for flow rates of 2000 to 2500 m³/h for most filters. On the other hand, a higher filter class (H11) was achieved for a flow rate of 500 m³/h for filters with 28 pleats/100 mm density.
- High mobility particles lower the diffusion efficiency of the filter.
- Efficiency decreases with increasing filter face velocity for particle sizes less than the MPPS at this face velocity. Beyond the MPPS, increasing the filter face velocity also increases the efficiency of filter. The minimum efficiency decreases with increasing flow rate, with the lowest efficiency occurring at the highest flow rate of 3000 m³/h.
- The Interception coefficient for all tested filters is independent of flow rate and number of pleats. On the other hand, the coefficient applying to the diffusion contribution to the efficiency becomes greater as the flow rate increases and the pleating density decreases.

REFERENCES

1. Davies C.N., 1973, *Air Filtration*, Academic Press, New York.
2. Brown R.C., 1993, *Air Filtration: An Integrated Approach to the Theory and Application of Fibrous Filters*, Pergamon Press, Oxford.
3. Letourneau P., Mulcey Ph. and Vendel J., 1990, Aerosol penetration inside HEPA filtration media, *Proc. 21st DOE/NRC Nuclear Air Cleaner Conference*, CONF-900813.
4. Wakeman R.J., Hanspal N.S., Waghode A.N. and Nassehi V., 2005, Analysis of pleat crowding and medium compression in pleated cartridge filters, *Trans IChemE*, **83**(A10), 1246-1255.

5. Chen D.R., Pui D.H. and Liu B.Y.H., 1995, Optimization of pleated filter designs using a finite-element numerical model, *Aerosol Science and Technology*, **23**, 579-590.
6. Fabbro L.D., Laborde J.C., Merlin P. and Ricciardi L., 2002, Air flows and pressure drop modelling for different pleated industrial filters, *Filtration & Separation*, **39**(1), 34-40.
7. DIN 1822
8. Lee K.W. and Liu B.Y.H., 1982, Theoretical study of aerosol filtration by fibrous filters, *Aerosol Science and Technology*, **1**(2), 147-161.
9. Liu B.Y.H. and Rubow K.L., 1986, Air filtration by fibrous media, in *Fluid Filtration: Gas*, **1**, ASTM STP 975, (R.R. Raber (Ed.)), *American Society for Testing and Materials*, Philadelphia, 1-12.
10. Payet S., Boulaud D., Madelaine G. and Renoux A., 1992, Penetration and pressure drop of HEPA filter after loading with submicron liquid particles, *J. Aerosol Sci.*, **23**, 723-735.

FIGURES AND TABLES

Filter	Pleat density (pleats/100 mm)	Surface area (m ²)
28A	28	23.9
28B	28	24.6
30A	30	26.6
30B	30	26.6
32A	32	27.3
32B	32	27.3
34A	34	28.8
34B	34	28.9

Table 1: The filters tested and their surface areas.

HEPA (H10) FILTER MEDIUM	
Fibre diameter range	0.5-8.5 μm
Average fibre diameter	2.1 μm
Media thickness	500 μm
Packing density	0.1 μm
Porosity	94%
Fibre shape	Circular

Table 2: Properties of the filter medium.

Filter Q (m ³ /h)	28A (23.9 m ²)			30A (26.6 m ²)			32A (27.3 m ²)			34A (28.8 m ²)		
	Δp (Pa)	V_f (mm/s)	$k \times 10^{-12}$ (m ²)	Δp (Pa)	V_f (mm/s)	$k \times 10^{-12}$ (m ²)	Δp (Pa)	V_f (mm/s)	$k \times 10^{-12}$ (m ²)	Δp (Pa)	V_f (mm/s)	$k \times 10^{-12}$ (m ²)
500	14	5.78	3.82	18	5.22	2.68	14	50.84	3.36	15	4.82	2.97
1000	30	11.57	3.57	30	10.44	3.22	27	10.17	3.48	29	9.64	3.07
1500	47	17.36	3.42	47	15.65	3.08	44	15.25	3.21	45	14.45	2.97
2000	66	23.12	3.24	65	20.86	2.97	63	20.34	2.99	63	19.27	2.83
2500	87	28.90	3.08	86	26.08	2.81	83	25.42	2.83	81	24.09	2.75
3000	111	34.68	2.89	108	31.30	2.68	105	30.50	2.69	105	28.905	2.55
3500	135	40.46	2.78	132	36.52	2.56	129	35.59	2.55	128	33.72	2.44
4000	162	46.24	2.64	159	41.74	2.43	155	40.67	2.43	153	38.54	2.33
4500	191	52.02	2.52	188	46.96	2.31	183	45.75	2.31	182	43.36	2.20
5000	222	57.80	2.41	218	52.20	2.21	213	50.84	2.21	213	48.18	2.09

Filter Q (m ³ /h)	28B (24.6 m ²)			30B (26.6 m ²)			32B (27.3 m ²)			34B (28.9 m ²)		
	Δp (Pa)	V_f (mm/s)	$k \times 10^{-12}$ (m ²)	Δp (Pa)	V_f (mm/s)	$k \times 10^{-12}$ (m ²)	Δp (Pa)	V_f (mm/s)	$k \times 10^{-12}$ (m ²)	Δp (Pa)	V_f (mm/s)	$k \times 10^{-12}$ (m ²)
500	17	5.64	3.07	15	5.23	3.22	15	5.09	3.14	15	4.80	2.96
1000	30	11.29	3.48	30	10.46	3.22	29	10.19	3.25	29	9.61	3.06
1500	47	16.94	3.33	48	15.69	3.02	45	15.29	3.14	47	14.41	2.84
2000	66	22.58	3.17	66	20.92	2.93	63	20.38	2.99	63	19.21	2.82
2500	86	28.23	3.04	87	26.15	2.81	84	25.48	2.81	84	24.01	2.64
3000	108	33.88	2.90	111	31.38	2.61	107	30.57	2.64	107	28.82	2.49
3500	134	39.52	2.73	136.5	36.61	2.47	131	35.67	2.52	131	33.62	2.37
4000	161	45.17	2.60	165	41.83	2.35	158	40.76	2.39	159	38.42	2.24
4500	188	50.81	2.50	193.5	47.06	2.24	186	45.86	2.28	186	43.22	2.15
5000	218	56.46	2.40	226.6	52.29	2.13	216	50.95	2.18	218	48.03	2.04

Table 3: Initial pressure drop, face velocity and permeability for different pleating densities.

	Diffusion term	Interception term	Remarks
Liu & Rubow [9]	$E_D = 1.6 \left(\frac{1-\alpha}{Ku} \right)^{1/3} Pe^{-2/3} C_d$	$E_R = 0.6 \left(\frac{1-\alpha}{Ku} \right)^{1/3} \frac{R^2}{1+R} C_r$	$C_d = 1 + 0.388Ku \left[\left(\frac{1-\alpha}{Ku} \right) Pe \right]^{1/3}$ $C_r = 1 + \frac{1.996Ku}{K}$
Lee and Liu [8]	$E_D = 2.6 \left(\frac{1-\alpha}{Ku} \right)^{1/3} Pe^{-2/3}$	$E_R = \left(\frac{1-\alpha}{Ku} \right)^{1/3} \frac{R^2}{1+R}$	
Payet et al. [10]	$E_D = 2.6 \left(\frac{1-\alpha}{Ku} \right)^{1/3} Pe^{-2/3} C_d C_d'$	$E_R = 0.6 \left(\frac{1-\alpha}{Ku} \right)^{1/3} \frac{R^2}{1+R} C_r$	$C_r = \frac{1}{1+E_D}$

Table 4: Efficiency models examined in this study.

Flow rate (m ³ /h)	Filter 28A		Filter 30A		Filter 32A		Filter 34A	
	β_1	β_2	β_1	β_2	β_1	β_2	β_1	β_2
500	1.7	3.6	0.85	3.6	0.81	3.6	0.78	3.6
1000	2	3.6	1.8	3.6	1.79	3.6	1.73	3.6
1500	2.05	3.6	1.85	3.6	1.82	3.6	1.77	3.6
2000	2.27	3.6	2.1	3.6	2.02	3.6	2.00	3.6
2500	2.5	3.6	2.25	3.6	2.18	3.6	2.17	3.6
3000	2.6	3.6	2.5	3.6	2.35	3.6	2.35	3.6

Table 5: The values β_1 and β_2 obtained for the different flow rates for Group A filters.

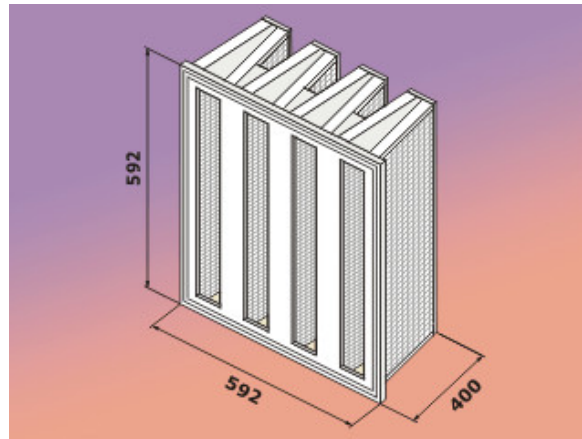

Figure 1: Pleated filter with the V shape design (EMW Filtertechnik).

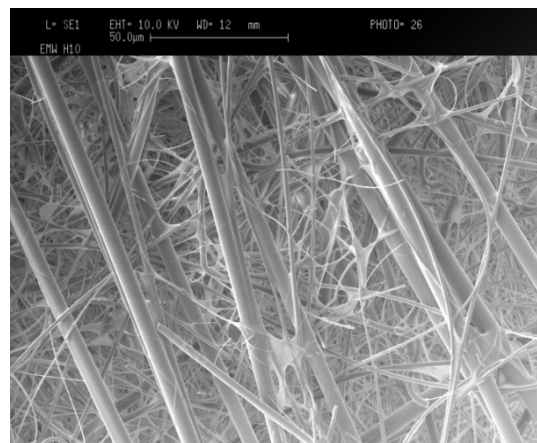

Figure 2: Image of the glass fibre HEPA filter medium (Class H10 according to DIN 1822).

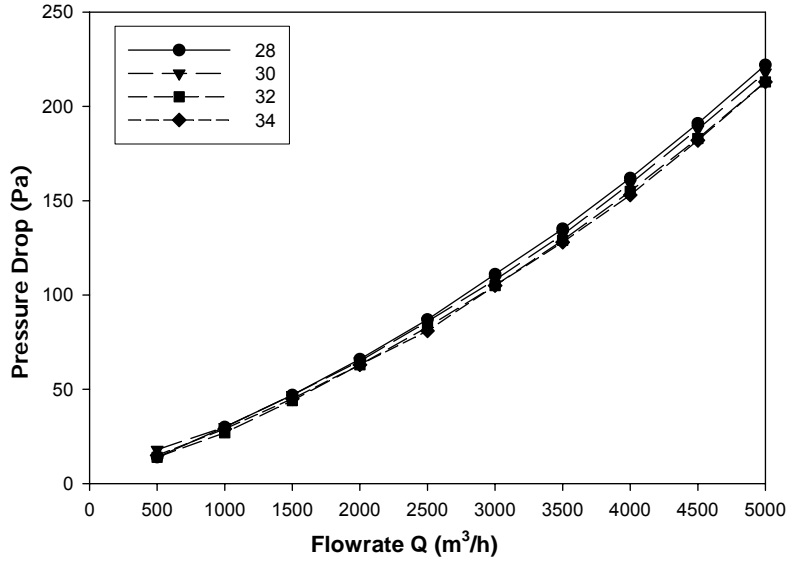

Figure 3: Initial pressure drop versus flow rates for group A filters.

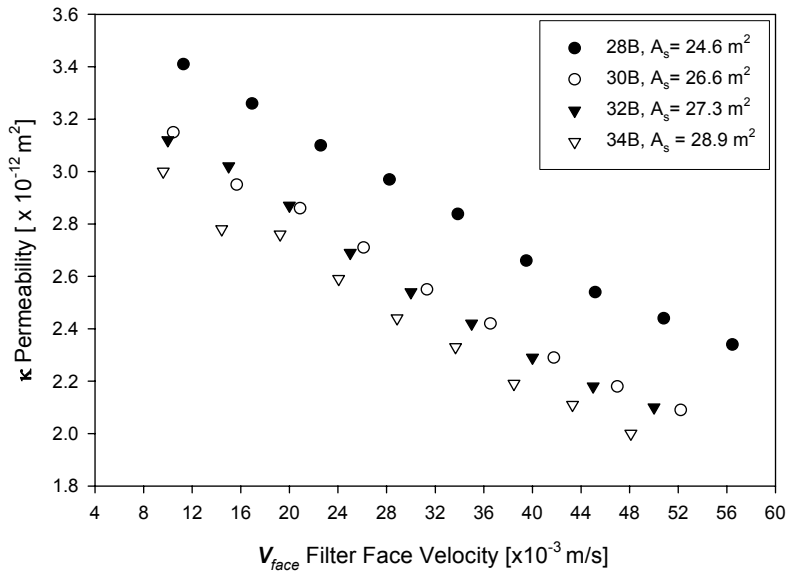

Figure 4: Permeability versus face velocities for filters of group B.

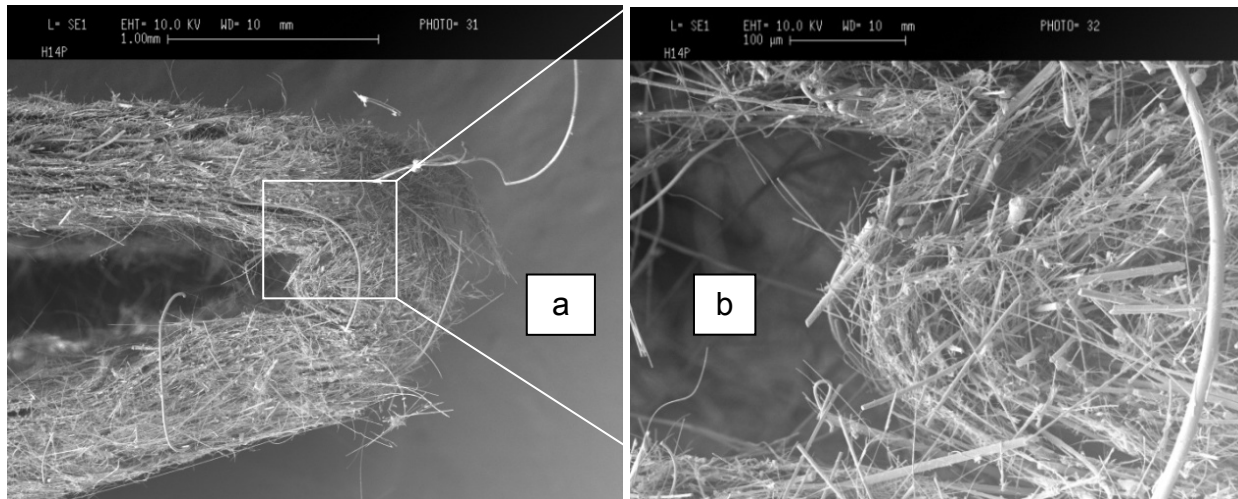

Figure 5: Views showing the crease in a mini-pleat: (a) Compression at the inner bend of a single pleat of the glass fibre media used, and (b) an enlarged view of the compressed zone of the pleat.

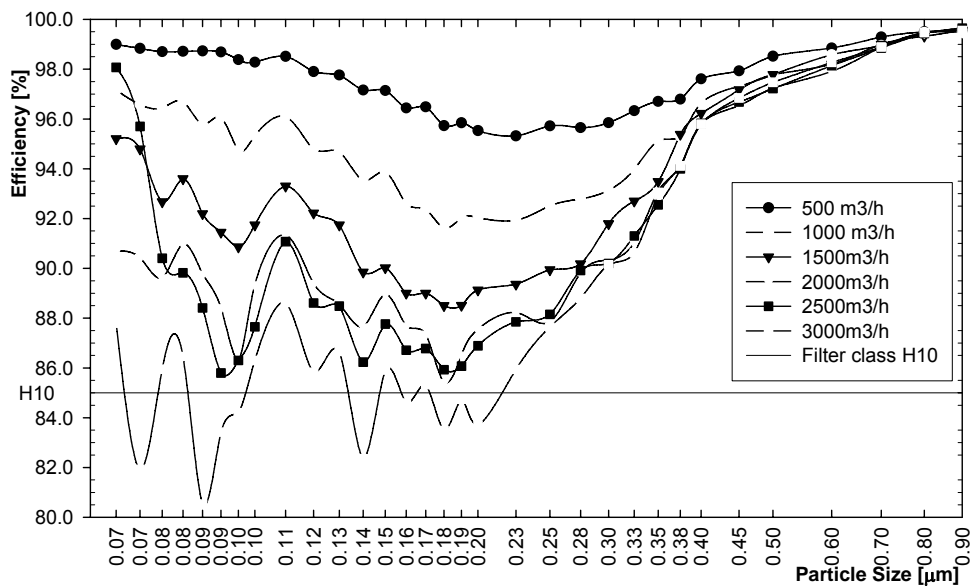

Figure 6: Initial efficiency (DIN 1822) vs. particle size for different flow rates (filter 28B).

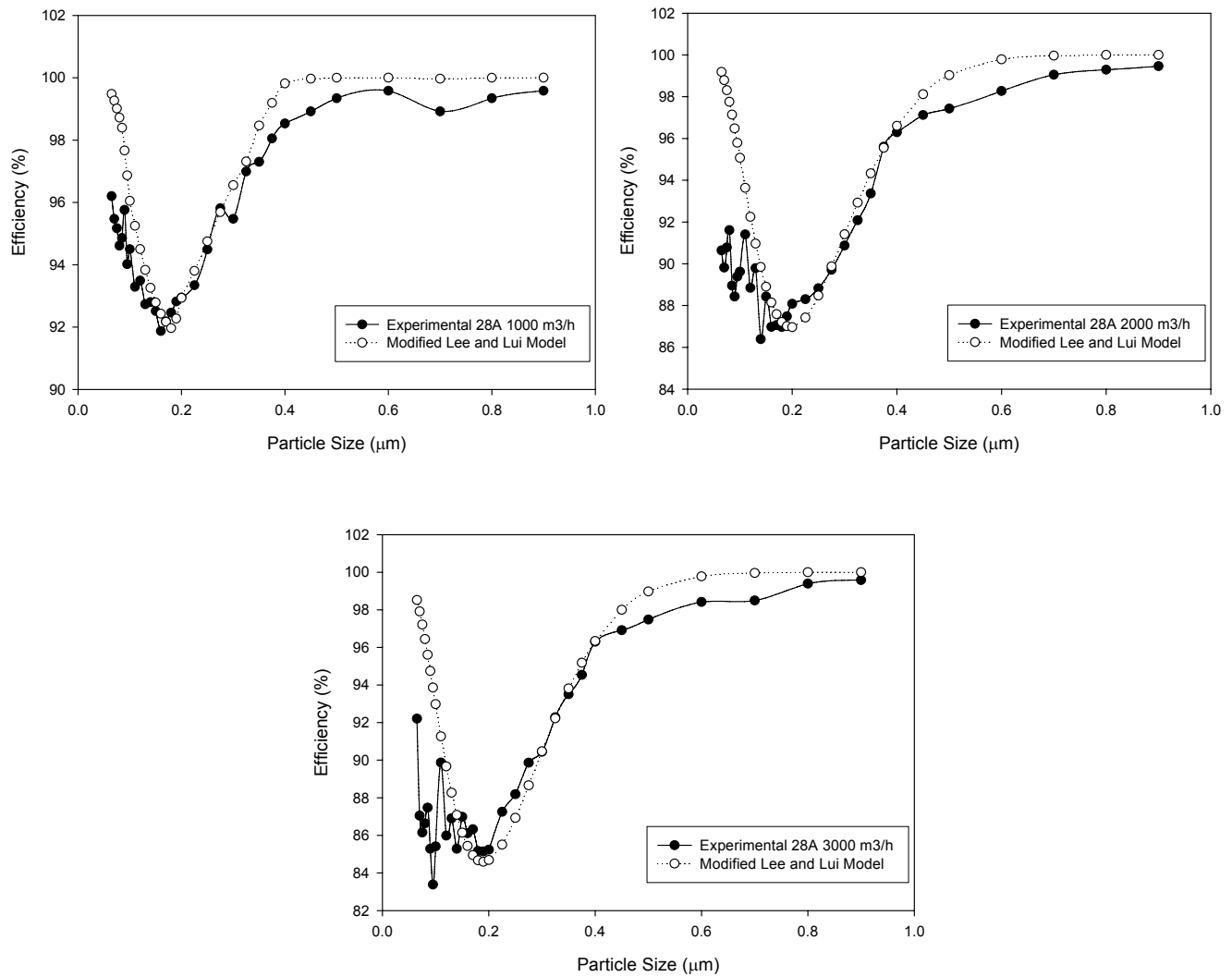

Figure 7: Initial efficiency comparison between experimental results and the theoretical model of Lee & Liu [8].