

This item was submitted to [Loughborough's Research Repository](#) by the author.
Items in Figshare are protected by copyright, with all rights reserved, unless otherwise indicated.

Insitu assessment of stiffness modulus for highway foundations during construction

PLEASE CITE THE PUBLISHED VERSION

PUBLISHER

© ISAP

LICENCE

CC BY-NC-ND 4.0

REPOSITORY RECORD

Fleming, Paul R., John Peter Lambert, Matthew W. Frost, and C.D.F. Rogers. 2019. "Insitu Assessment of Stiffness Modulus for Highway Foundations During Construction". figshare. <https://hdl.handle.net/2134/3553>.

This item was submitted to Loughborough's Institutional Repository by the author and is made available under the following Creative Commons Licence conditions.

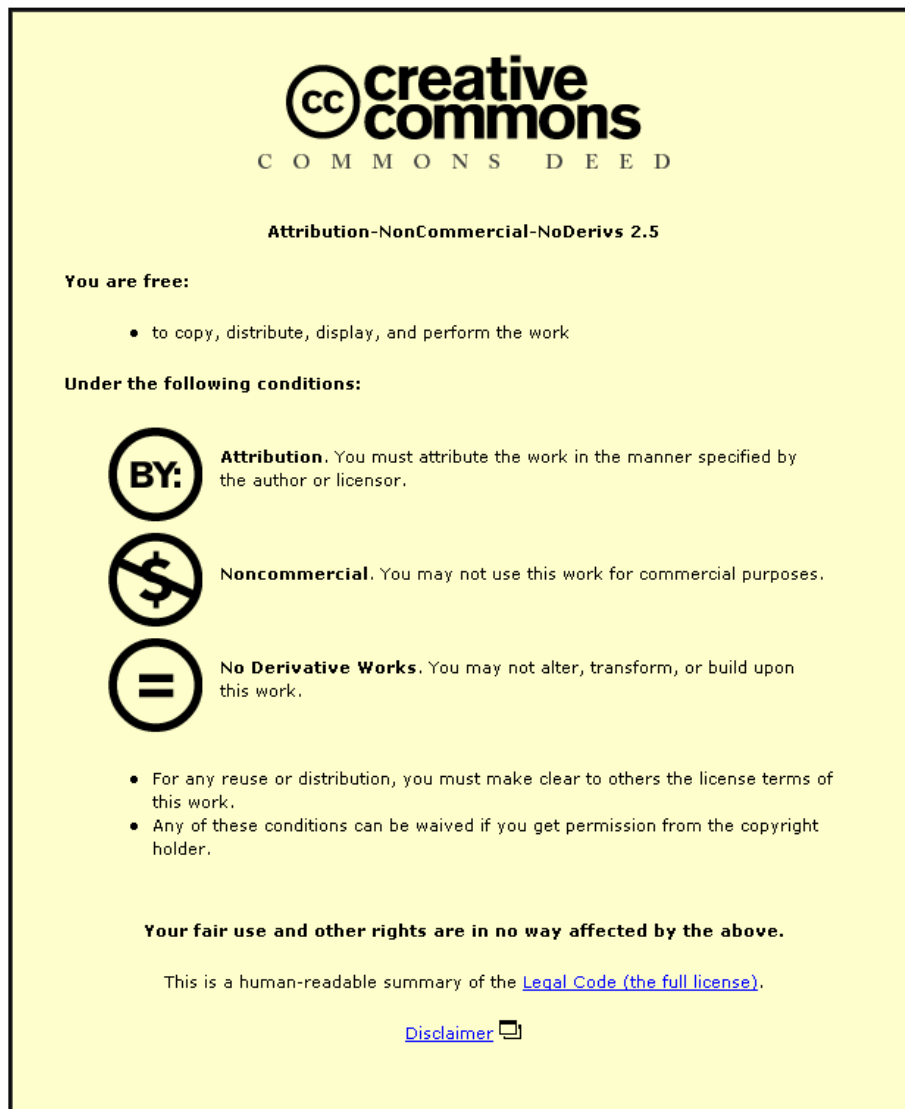

For the full text of this licence, please go to:
<http://creativecommons.org/licenses/by-nc-nd/2.5/>

In situ assessment of stiffness modulus for highway foundations during construction.

P R Fleming & M W Frost

Loughborough University, Department of Civil and Building Engineering, Loughborough, LE11 3TU, England & Nottingham Trent University, Department of Civil Engineering, Newton Building, Burton Street, Nottingham, NG1 4BU, England.

C D F Rogers

The University of Birmingham, School of Civil Engineering, Edgbaston, Birmingham, B15 2TT, England.

ABSTRACT: Several portable field devices that measure stiffness modulus are reviewed in detail in this paper including the German Dynamic Plate Test (also known as the Lightweight Drop Tester), the TRL foundation tester (UK), the Prima (Denmark) and the Humboldt Soil Stiffness Gauge (USA, also known as the GeoGauge). Laboratory and field data are presented which explain the many important influences on the measured data and demonstrate comparative performance with respect to the Falling Weight Deflectometer. These field data show significant scatter and site specific correlation. A strategy for compliance testing during construction, as part of a performance-based specification approach for the UK, is suggested. Conclusions are made regarding the devices' relative merits and limitations, and considerations for their introduction into contractual use for routine assessment during construction.

1. INTRODUCTION

A key functional parameter of a pavement foundation is its resilient elastic stiffness or stiffness modulus as it is called hereafter. This parameter is both a measure of the quality of support which it provides to the overlying asphalt or concrete layers and a factor that determines the stresses, and hence strains, that are transmitted to the subgrade. Recent developments of in-situ testing devices have now made it possible to obtain a direct measurement of the stiffness modulus during construction. The future use of such devices for compliance testing is becoming a real possibility and ultimately may be expected to aid in superseding the use of the CBR test, considered by many as no more than a simple index test.

There are several portable test devices that reportedly measure the in situ stiffness modulus for the highway foundation material under test. Those reviewed in detail in this paper include the Falling Weight Deflectometer (trailer mounted), the Humboldt Soil Stiffness Gauge, and several 'dynamic plate test' devices such as the German Dynamic Plate Test (also known as the Lightweight Drop Tester), the TRL foundation tester (UK), and the Prima (Denmark). These dynamic plate devices measure a composite stiffness under a transient load pulse, which is applied to the ground by dropping a weight onto a bearing plate via a rubber buffer. The deflection of the ground is measured and combined with the applied load, which is either measured or is assumed to be constant (by means of a constant drop height), to calculate the stiffness using conventional Boussinesq static analysis. The portable dynamic plate test devices typically can apply a stress pulse of 100 to 200kPa over a period of approximately 20 milliseconds, usually via a 300mm diameter plate and have been used for testing typical road foundation materials. They exhibit many similarities in their mechanics of operation although there are subtle differences in their design and mode of operation, and which may lead to a variation in their measured results. The Humboldt Soil Stiffness Gauge, however, is a relatively small vibratory test device and operates in a quite different way to the plate devices.

Measurements of the stiffness modulus are widely used as compliance testing for construction control elsewhere in Europe [Thom, 1993]. Although the static plate load bearing test is widely adopted, it is increasingly being replaced by the portable and quicker dynamic plate tests which are described here. A suitable field test device will ideally be able to cope with the varied materials that could be encountered, including very coarse-grained, and be sensitive enough to distinguish between contrasting performance over a possible large range of stiffness to include both soft subgrades and cemented materials.

2. TEST DEVICES

To replicate construction vehicle wheel loading, an in-situ test device should ideally measure the response of: a transient load pulse of around 40 milliseconds or longer and with the load applied through a bearing plate approaching 500 mm in diameter (to simulate a twin tyre configuration) at a contact stress of around 200 kN/m² [Fleming and Rogers, 1995]. In reality, however, the required contact stress and load pulse duration required to mimic vehicle loading on a layer at a given depth in a partially completed pavement will vary due to the stress dependency of the materials used in the pavement. Therefore some flexibility in the loading applied by a device is desirable. The portable devices measure deflection via a central geophone (or accelerometer) only, thus assessing the foundation's composite stiffness only and precluding individual layer stiffness by backanalysis. A description of the testing devices is given below and Table 1 shows their pertinent features for easy comparison.

2.1 Falling Weight Deflectometer (FWD)

The FWD is well known as a pavement evaluation tool. It is trailer-mounted and comprises a weight that is raised and dropped mechanically onto the 300mm diameter steel bearing plate via a set of rubber cushions by in-vehicle computer control. The drop height, weight and plate size can be varied to obtain the required contact pressure, over a large range. The load pulse duration is 25 to 40 milliseconds dependent on the material under test. The applied stress and surface deflections, from up to seven radially spaced velocity transducers, can be recorded automatically and backanalysed to infer individual layer stiffnesses. However, for testing unbound materials it is common to utilise only the central transducer and determine a 'composite foundation modulus'. The central velocity transducer bears onto the ground through a hole in the bearing plate.

2.2 German Dynamic Plate Bearing Test (GDP)

The GDP is described in the German specification [1992] and is shown in Figure 1. It comprises a total mass of 25kg, and a falling mass of 10kg that loads through a rubber buffer the 300mm diameter bearing plate. An accelerometer is mounted within the plate. The drop height of the falling mass is set such that the peak applied force is 7.07 kN (i.e. 100 kPa contact stress) when calibrated on a standard (manufacturer's) foundation. The actual applied force is not measured during testing. The load pulse duration is (reportedly) 18±2 milliseconds, and can reputedly measure a stiffness modulus in the range 10-225 MN/m² to a depth of 1.5 plate diameters (there are various manufacturers who claim slightly different ranges). The device is recommended for use on stiff cohesive soils, mixed soils and coarse-grained soils up to 63 mm in size.

The operational procedure recommended for the GDP (also adopted for the FWD in this work to allow direct comparison) is six drops on the same spot to provide a single value of stiffness. The first three drops are termed pre-compaction, to remove any bedding errors, and are ignored. The deflections of the next three drops are recorded and displayed on the readout together with the computed average stiffness.

2.3 TRL Foundation Tester (TFT)

The TFT [Rogers et al, 1995], shown schematically in Figure 2, comprises a manually raised 10 kg mass that is released from a height controlled by the operator (maximum of 1.2m) and falls onto a 300 mm diameter bearing plate via a single rubber buffer. The total mass of the apparatus is 30kg. The load pulse duration is 15 to 25 milliseconds. The applied force and the deflection, inferred from a velocity transducer measuring through a hole in the bearing plate, are recorded automatically. The deflection derived for the material under test is determined by single integration of the velocity transducer signal. It currently exists as a working prototype. The operational procedure used for the TFT was the same as that used for the GDP. To match a target contact stress (e.g. 100kPa) a low and medium/high drop height is used and interpolation carried out.

2.4 Prima

The Prima is a device that has been relatively recently developed and marketed by Carl Bro Pavement Consultants (previously Phønix), and is very similar in specification to the TFT. It weighs 26kg in total and has a 10kg falling mass that impacts the bearing plate via four rubber buffers (of the same specification as that used in the TFT) to produce a load pulse of 15-25 milliseconds. It has a load range of 1-15kN, i.e. up to 200kPa with its 300mm diameter bearing plate. It measures both force and deflection, utilising a velocity transducer (calibrated to a deflection of 2.2mm). The recent models have modified the velocity transducer mounting to measure on the ground through a hole in the plate (used here). Up to two extra geophones can be utilised to provide a simple deflection bowl. The device requires a portable computer for data output and analysis, the proprietary software being provided with the device. There is little published data relating to its efficacy to date.

2.5 Humboldt Soil Stiffness Gauge (SSG)

The Humboldt Soil Stiffness Gauge (also known as the GeoGauge) is shown schematically in Figure 3. It weighs 10kg in total, is 28cm in diameter and 25.4cm tall, and rests on the ground surface via a ring shaped foot. The test reportedly takes approximately 2 minutes to carry out and the output data can be viewed in several forms including 'Young's Modulus'.

The SSG works by applying a range of excitation frequencies to the ground, in the range 100 to 200Hz, through a 114mm radius plate and measuring the response. The displacements imparted to the soil are very small, reportedly (ref) in the range 1.27×10^{-6} m. The applied force and velocity are measured to determine the ground stiffness K (MN/m). This is then converted to a value of E (in MPa) and the workable range is stated as 26 to 193 MPa. The device typically applies 25 different steady state frequencies of excitement and then reports the *average* stiffness of the ground (this data can be stored for later downloading to a PC).

The SSG can apparently be used for earthwork constructions with regard to many requirements such as mechanistic design validation, performance specification development, and alternative density measurement.

3. LABORATORY INVESTIGATIONS

To investigate the mechanical-related apparatus influences on the test results, a series of controlled laboratory tests were carried out and are reported in more detail elsewhere [Fleming, 2000]. In that study the significance of variables such as drop height, bearing-plate mass, and stiffness of the rubber (damper) buffer were investigated. A 500mm thick layer of granular soil was compacted and instrumented with pressure cells to explore the effects of dynamic plate loading and the associated subsurface stress distribution, and also in comparison to static load bearing plate tests. A guided falling mass of 10 kg, consistent with the portable field devices, and two 300mm diameter bearing plates, of 15 and 25 kg mass, were utilised. Quartz shear-mode single-axis accelerometers were utilised for measurement of motion of both the falling mass and the bearing plate. Three rubber

dampers were experimented with, varying in stiffness (determined as 150kN/m, 500 kN/m and 1100 kN/m from the manufacturer's data). The accelerometer and pressure cell measurements were recorded on the same time base utilising a 20kHz 8-channel Analogue to Digital board and PC. The accelerometer mounted on the bearing plate was integrated twice, with respect to time, to interpret a deflection-time history. Of particular interest was the occurrence, with respect to time, of the inferred peak deflection of the bearing plate relative to that of the maximum applied force to evaluate the dynamic loading effects (i.e. phase). The bearing plate, initially at rest, is accelerated by the impact of the falling mass and then decelerated as the material under test resists the downward movement. The bearing plate initially *reduces* the net force applied to the soil, due to self-inertia from initially being at-rest, and then subsequently *increases* the net force applied due to its self-inertia when in-motion. The pressure cell readings clearly showed the soil damping effects.

Adjusting the rubber damper stiffness and/or mass of bearing plate clearly demonstrated the inertia effects. For the stiffest damper there was a significant phase difference between the time to peak deceleration of the falling mass and the time to peak deflection of the bearing plate (load pulse durations were around 11 milliseconds). This phase difference was reduced for a reduction in damper stiffness, with an associated longer loading pulse as expected. The lowest stiffness damper showed that the inferred peak deflection occurred at approximately the same point in time as that of the peak force (i.e. was in-phase or pseudo-static loading), and this occurred for load pulse durations of 18milliseconds. The buried pressure cells showed that for the lowest stiffness damper the maximum values of pressure measured were reduced and the cell pulse duration increased relative to the stiffer dampers. In general, the lower stiffness dampers produced more repeatable results and more symmetric loading pulses.

The effect of increasing the mass of the bearing plate was observed to have very little effect on the magnitude of deceleration of the falling mass, or the load pulse times in general, but did increase the peak accelerations on the bearing plate (i.e. increased resistance to motion). The increase in mass from 15kg to 25kg of the bearing plate consequently produced a 25% reduction in the inferred peak deflection. The increase in the bearing plate mass reduced the maximum recorded soil pressures by around 10%. No discernible change in the duration of pressure cell pulse duration was observed for this increase in mass, however, showing that some of the impact/kinetic energy is not transferred into the soil and is used by accelerating the heavier bearing plate system (i.e. more inertia) corroborating the plate accelerometer findings.

These data highlight the importance of a carefully considered specification for a field dynamic plate device, and go some way to explain the reason for differences in their output.

Another important difference between the specification of the portable field devices is with regard to the location of the motion transducer, i.e. whether they measure on the plate or ground (see Table 1). The GDP and SSG measure *on* (or for the GDP within) the ground bearing plate. The FWD and Prima geophone are sprung to provide a down-force onto the ground through a hole in the plate (the Prima has a softer spring than the FWD), and the TFT geophone currently relies upon only its self-weight with no spring to maintain a firm contact with the ground. In addition, the FWD bearing plate is attached to its loading system and trailer frame. This provides an estimated static pre-load of perhaps as much as 50kPa for the FWD with a 300mm bearing plate (compared with static preload of approximately 4kPa for the TFT and Prima and less than 1kPa for the SSG). These differences between the devices may be expected to further affect their respective measurements, especially when measuring on highly stress dependent materials. It could be reasoned that (motion) measurement on the bearing plate, and not directly on the ground, would be less susceptible to surface contact problems. This has been investigated [Van Gurp et al, 2000] on very stiff self-cementing materials with the FWD and it was concluded that measurement on the ground was *more accurate*, based upon validation by laboratory triaxial measurements. It was observed therein that velocity measurement on the (FWD) plate produced a *lower* stiffness (i.e. larger deflection) relative to measurement on the ground. The rigidity of the bearing plate is an important factor in this argument. For a truly rigid plate the material displacement beneath it should be uniform, from static elastic theory, and thus the geophone on the plate would be expected to read the same as for the ground under test. However, it was evident from the previous discussion that a transducer mounted

on the bearing plate will also record the initial acceleration of the plate, as opposed to one mounted on the soil. Thus, it may be inferred from this finding that the GDP device is expected to measure a consistently larger deflection (i.e. lower stiffness modulus).

The effect of the location of the motion transducer has been investigated by a simple series of tests carried out in a rigid box, 1m by 1m in plan and 0.6m deep. A well-graded crushed rock granular backfill (40mm down, sub-base) was placed and compacted in five equal layers. The TFT and GDP dynamic plate devices were used, at 100kPa contact stress, and the tests were repeated with a second 300mm diameter rigid steel plate (10kg mass) that was placed between the device's bearing plate and the test material. Figure 4 shows the results for one series of tests (six test positions) on a 550mm compacted thickness of granular material. The GDP measured a consistently lower stiffness than the TFT, in general. The effect of the extra plate on the GDP is to slightly *increase* the stiffness measured (i.e. reduce peak deflection) due to energy lost in accelerating the extra mass in accordance with the previous laboratory findings. For the TFT the stiffness values are nearly all reduced (i.e. larger deflections inferred) in accordance with the findings of Van Gurp [2000]. The effect of restraining the TFT geophone in this way increased the interpreted deflections by as much as almost 100% at position 3. In general, however, the scatter in stiffness modulus measured was observed to reduce, and more so for the TFT.

4 FIELDWORK RESULTS

The dynamic plate devices (FWD, GDP, TFT and Prima) have been utilised extensively on both commercial and purposely built trial road foundations during a recent research programme. Typically the sites visited comprised foundations of clayey subgrades, crushed rock granular capping (75mm down) and/or granular sub-base (typically 37.5mm down and tighter grading envelope than the capping). In general, at each site a series of plate tests were carried out at 10 test locations along a construction length of typically 30m. For simple comparison between devices, the correlation coefficients (CC) were determined from simple trendline fitting (straight line forced through the origin). The coefficient of variation (CoV) was also determined (i.e. the ratio of standard deviation to the mean, expressed as a percentage) for each series of tests. The detailed data are presented elsewhere (Fleming et al, 2000) and briefly summarised here.

The SSG was evaluated during a separate programme from comparison with the GDP at a series of highway reinstatement excavations. At each site the two devices were tested out on the same point, and at up to three different locations on the compacted backfill. The backfill comprised well-graded granular crushed rock (40mm down, a Type 1 sub-base). There was occasional opportunity to measure on each of up to four layers of backfill, with a typical lift thickness of 150mm.

4.1 Stiffness Magnitude and Variability

A very wide range of values has been measured to date with the average stiffness modulus (for each series of tests) in the range 8 to 211MPa with the FWD, 13 to 100MPa with the GDP, and 11 to 306MPa with the TFT. The GDP gave consistently lower readings than the other devices. Figure 5 shows measurements on a 400mm thick granular (gravel) capping using all three stiffness measuring devices at ten equally-spaced locations, along a 20m test length in this case. It shows reasonable parity between the FWD and TFT, whilst the GDP is consistently lower but follows the same general pattern. In many instances, however, the relocation of a test at only 1 diameter away gave a significantly different stiffness modulus, whereas repeat tests on the same spot were considered to be consistent.

The variability in measured stiffness modulus for each test device, for any one series (i.e. the same construction), was quantified by the coefficient of variation expressed as a percentage. In general, greater variability was observed for tests on the natural sub-formations encountered than for the more controlled capping or sub-base materials. The variability for the sub-formations was generally in the range of 25 to 60% for the FWD and the TFT, and in the range of 20 to 50% for the GDP. For the capping the variability was generally in the range of 10 to 35% with the FWD, 20 to

40% with the TFT and 20 to 40% with the GDP. Recent work on the top of *completed* foundations, i.e. top of sub-base, has provided relatively low CoV values of around 15% with both the GDP and the Prima.

Where possible, tests were carried out at precisely the same location on successive layers and an improvement in stiffness was evident. From the FWD results for granular capping (typically 400mm thick) over the sub-formation an average modular ratio of 1.7 was determined and for sub-base (typically 150mm thick) over capping the ratio was 1.5 with the Prima. However, it was also observed that an exposed and dried out clay sub-formation can give greater stiffness modulus than a thick layer of granular capping highlighting the importance of careful interpretation of the data.

The fieldwork comparing the SSG to the GDP on sub-base backfill (in highway reinstatements) gave values of CoV in the range 5-20% for both devices (for small samples of only 3-6 tests, however). The SSG stiffness data were in *all* cases greater than the GDP values, consistent with the other fieldwork findings. Where an increase in stiffness was observed with the GDP, an increase in stiffness was also observed with the SSG. The SSG also recorded a greater range of stiffness values, possibly suggesting greater sensitivity than the GDP. However, the stress applied with the SSG is very low in comparison to the other devices.

4.2 Correlation between Devices

Comparison between devices using a correlation coefficient (CC), determined from simple straight-line curve fitting (forced through the origin) and using the FWD data as a benchmark, has indicated site specific relationships. Considering all the sites, the GDP gave a CC range of 0.43 to 1.41, with the majority in a band from 0.46 to 0.70. The TFT was found to correlate more closely to the FWD, with a CC range of values from 0.81 to 1.40. In addition, seven out of the ten TFT data sets were within $\pm 20\%$ of the FWD readings. The Prima has been found to correlate well with the FWD, giving 0.97 (from only one data set) at a site where the TFT gave a CC of 1.13 and the GDP 0.63. The correlation coefficients are useful for comparing global sets of data, but in general large scatter exists (evidenced by poor R^2 values, i.e. goodness of fit of the trendlines). Figure 6 shows a typical set of data for test on 400mm of capping and the clayey subgrade.

Figure 7 shows the relationship of the SSG and GDP testing for all the data (50 tests), and the trendline suggests that the SSG stiffness modulus is 1.3 times greater than the GDP, but with large scatter. In general, the SSG stiffness modulus was more repeatable and correlated better with the GDP for the tests on thicker layers of sub-base. This could perhaps be attributed to the more uniform compaction state existing and/or the shallower depth of measurement of the SSG. More work is clearly required with this device to reach clear conclusions as to its accuracy/correlation with other devices. Seikmeier (Seikmeier et al, 2000) also evaluated the SSG, with an FWD, Loadman (also a small portable dynamic plate device, developed in Finland) and the Dynamic Cone Penetrometer. Relatively few data were presented however, though it was concluded that similar trends were observed for the stiffness measuring devices in comparison to % compaction of the soil under test.

4.3 Stress Dependency

Figure 8 presents the results of a study of the stress dependency of the compacted granular materials and the subgrade soils for one of the trial foundation sites. The figure shows that the applied stress varied from approximately 35 to 120 MPa with the Prima and TFT, with a strong stress dependency for the tests on granular sub-base, as expected. The FWD measured no change in stiffness modulus over its (higher) applied stress range. The FWD *minimum* stress is restricted to approximately 100 kPa, due to the minimum self-weight of the (automated) drop assembly, and was in the range 130 to 325kPa for these tests. The FWD stiffness modulus agrees reasonably well with those for both the TFT and Prima at their higher stress level. The GDP stiffness modulus is again approximately half that measured by the other devices. For the tests on the subgrade the Prima showed a small increase in stiffness modulus with applied stress, whereas the TFT showed a stronger stress dependency and

more so than for the granular material. However, the subgrade at this trial site has appreciable gravel content in the clay matrix.

The stress-dependent nature of both soils and granular materials complicates the comparison between test devices that apply different contact stresses, and this is especially difficult for the SSG, which applies a very low contact stress (<1 kPa).

5 DISCUSSION

It is clear that the field devices have each been developed to a different specification, perhaps dependent on the country of origin or for a specific intended use. In addition to variations in the mechanical properties for the dynamic plate tests (TFT, Prima and GDP), such as the bearing plate mass and stiffness of damper (largely controlling the load pulse duration), the transducer type and methods of measurement also varies. The interpretation of the transducer signal, with respect to smoothing and the method of integration (or in the case of the GDP double integration) is difficult to determine but may also add to the influences for variation in measured results. The rate of loading may be expected to introduce different dynamic effects in the ground under test, although pseudo-static conditions were identified in the laboratory investigations described herein. From this work a load pulse duration of >18 milliseconds was considered appropriate for a 15kg bearing plate (e.g. similar to the GDP and Prima), and somewhat longer (i.e. softer damper) is probably required for a 25kg bearing plate (e.g. for the TFT and FWD). However, the surface measured deflection at a single point is considered relatively complex for a multi-layered structure. The maximum deflection is an accumulation of the sub-surface strains, which will vary with both position and time. The static Boussinesq half-space analysis is currently utilised to determine the stiffness modulus and is a simplification, though further work is required to estimate the errors of using this approach.

The plate dimensions (i.e. diameter) will obviously affect the depth of significant stressing, and a diameter of 300mm appears to be the common standard adopted, for technical and portability reasons. However, the SSG has a 114mm diameter plate and it is proposed that further correlation/validation work is required with this device to determine the effects of this and the low stress regime on its stiffness modulus measurements.

The field data have shown a large range and variability of stiffness modulus readings on a variety of typical UK materials and constructions. More work is clearly required to expand the database and give greater confidence in the measurements for decision making. This work is ongoing.

6. SITE TESTING CONSIDERATIONS/STRATEGY

It is clear from the literature related to insitu assessment that many differing devices are increasingly being used in pavement engineering, and in some cases now form part of foundation construction specifications. In the UK, however, a method specification (MCDHW, 1993) is still largely employed with no 'as built' performance requirement. However, current research by the authors is further addressing this problem.

Current thinking on the required testing strategy incorporates both stiffness modulus testing and some form of resistance to permanent deformation requirement (to primarily avoid unnecessary damage caused by construction vehicles). The stiffness modulus testing strategy comprises testing each layer of the foundation (when completed and ready for the next overlying layer) to ensure adequate load spreading capability and also sufficient resilient support to allow full compaction of the next overlying layer. The setting of suitable target values stiffness modulus is under review but the proposed values have been determined from fieldwork. Testing each layer is considered superior to testing only on the completed foundation, although more effortful. It will help identify uniformity of construction and materials, identify soft spots and allow their remediation, provide a useful indicator of the general as built quality and informing engineers better with regard to the influences on material behaviour. In the longer-term better informed decisions may be able to be made with regard to the relative merits of the many different materials utilised (e.g. stabilised in comparison to

quarried aggregates) and facilitate innovative designs, which is currently difficult under UK guidelines.

The fieldwork carried out to date has shown significant variability in the measured stiffness modulus with any one device on the nominally same construction, and also between devices. If measurements are to be made on site during construction and compared to an absolute target value, then it would appear prudent to carry out careful full-scale trials either prior to or at the beginning of the contract to define the site specific relationships and assist with material/method selection. If the TFT, GDP or Prima were to be used, it is considered sensible to correlate these devices with FWD tests (or static plate load bearing tests based on the philosophy of the German Highway Works Specification) to improve confidence in their use.

The current programme of fieldwork is evaluating a statistical analysis approach whereby sets of tests have to be both all above an absolute minimum stiffness modulus value, and also their rolling average above a (higher) threshold value. In the absence of a consistent rationale for correcting one device's stiffness modulus values to that expected with another device, previous site relationships for similar constructions is being used to estimate an average correction factor for the use of the portable dynamic plate tests (e.g. for GDP to FWD). The current research programme is also evaluating the operational problems of implementing a performance-related specification, for the road foundation, into standard forms of contract.

7 CONCLUSIONS

The results from different stiffness modulus measuring devices can be dramatically different, for reasons yet to be fully evaluated. Some of this difference can be attributed to different transducers, their mounting, different load pulse durations and the mechanical specification of the device.

The GDP has been observed to give consistently lower stiffness modulus than the other test devices. One probable reason is the use of an accelerometer mounted within the bearing plate.

The Soil Stiffness Gauge has a very different mode of operation to the portable dynamic plate devices. The very low strain/stress amplitude is a cause for concern for testing stress dependent materials and when comparing it to other devices' data. However, it is simple to use and requires further experience to determine its potential role in field performance-related testing of stiffness modulus.

A specification including a requirement for assessment of stiffness modulus *in situ* needs to take proper account of the expected variation in the stiffness modulus of a foundation from one point to another and the effects of variations in applied stress (or rate of loading) on the material behaviour. These variations have been shown to be significant from tests at many varying sites on typical materials.

Commercial implementation a performance specification should, it is recommended, consider a pre-construction trial to assist both with material selection and device correlation, and also confidence in the attainment of the target values for compliance.

8. ACKNOWLEDGEMENTS

The authors would like to thank the UK Highways Agency (who have funded much of the fieldwork described), the UK Transport Research Laboratory, Kent and Northamptonshire County Councils, Advantica, and the many site contractors for their invaluable assistance with fieldwork access/permission. The fieldwork research programme was largely carried out by a team consisting of the authors, and Dr N Thom and Mr R Armitage of Scott Wilson Pavement Engineering (who co-ordinated much of the work). Their considerable assistance is gratefully acknowledged. The opinions expressed are solely those of the authors.

9. REFERENCES

- Earthwork and Foundations Working Party, 1992, Technical test specification for soil and rock in road-building, dynamic plate load test using a light falling weight device, TP BF-StB Part B 8.3, German Federal Ministry of Transport - Road Construction Department.
- Fleming, PR, 1999, Small-scale dynamic devices for the measurement of elastic stiffness modulus on pavement foundations, *Nondestructive testing of pavements and backcalculation of moduli: Volume 3*, ASTM STP 1375.
- Fleming, PR and Rogers, CDF, 1995, Assessment of pavement foundations during construction, *Transport, Proc. Institution of Civil Engineers*, 111 (2), pp 105-115.
- Fleming, PR, Rogers, CDF and Brown, AJ, 1995, Permanent deformation characteristics of unbound granular materials for highway foundations, *Proc. of the 4th Int. Symp. Unbound Aggregates in Roads (UNBAR4)*, Nottingham University, pp 271-280.
- Manual of Contract Documents for Highway Works, 1993, Specification for highway works, Volume 1, HMSO, London.
- Rogers, CDF, Brown, AJ and Fleming, PR, 1995, Elastic stiffness measurement of pavement foundation layers, *Proc. of the 4th Int. Symp. Unbound Aggregates in Roads (UNBAR4)*, Nottingham University, pp 271-280.
- Thom, NH, 1993, A review of european pavement design, *Proc. Euroflex*, Lisbon, pp 29-57.
- Van Gurp, C., Groenendijk, J, Beuving, E., 2000, Experience with various types of foundation tests, *Unbound Aggregates in Roads 5*, Edited by Dawson A., Balkema, pp.239–246.
- Fleming, P.R., Rogers, C.D.F, and Frost, M.W., 2000, A Comparison of Devices for Measuring Stiffness Insitu, *Unbound Aggregates in Roads 5*, Edited by Dawson A., Balkema, pp.239–246.
- Siekmeier J A, Young D, Beberg D., 1999, Comparison of the Dynamic Cone Penetrometer with other Tests during Subgrade and Granular Base Characterisation in Minnesota, *Nondestructive testing of pavements and backcalculation of moduli: Volume 3*, ASTM STP 1375.
- Humboldt Mfg. Co., 1999, User Guide: Soil Stiffness Gauge, Version 3.2, 16pp.

10. KEYWORDS

Insitu, Stiffness, Modulus, Foundation, Specification

TABLE 1 Test Device Specification

Device	Plate Diameter (mm)	Mass		Total Load Pulse (ms)	Deflection Transducer		Stress Range ^a (kPa)
		Falling Weight (kg)	Bearing plate (kg)		Type	On Plate Or Ground	
GDP	300	10kg	17	18±2	Accelerometer	Plate	100
TFT	300, 200	10kg	20	15-25	Velocity	Ground	< 120
Prima	300, 200, 100	10kg, 20kg	16	15-20	Velocity	Ground	< 200
FWD	300, 450	Adjustable	150 ^b	30-40	Velocity	Ground	> 100
HSG*	114mm	10kg (total weight)		Pulse frequency 100 to 196 Hz		Ground	< 1

Notes:

^a with 300 plate^b estimate

* Applies a low amplitude vibration to the ground

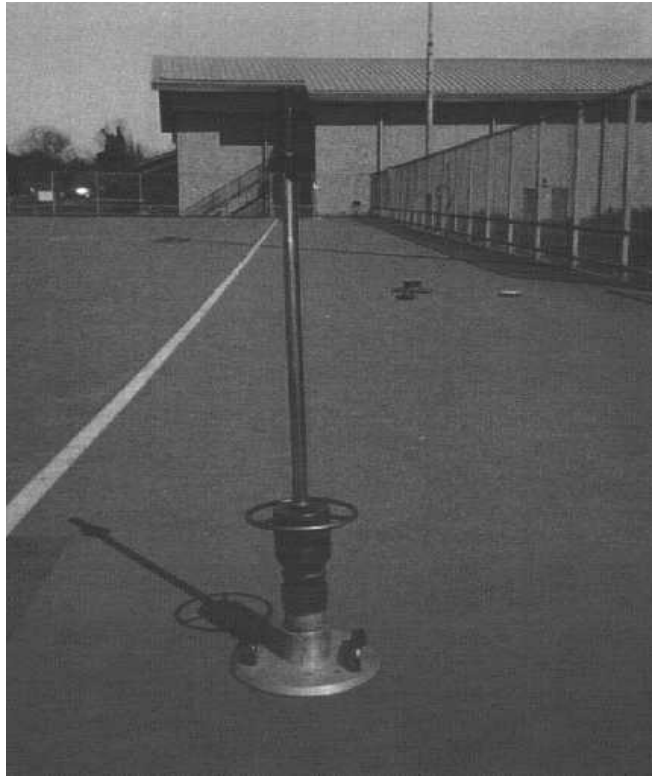

Figure 1. German Dynamic Plate test Apparatus
(Note: the falling weight is in the 'down' position)

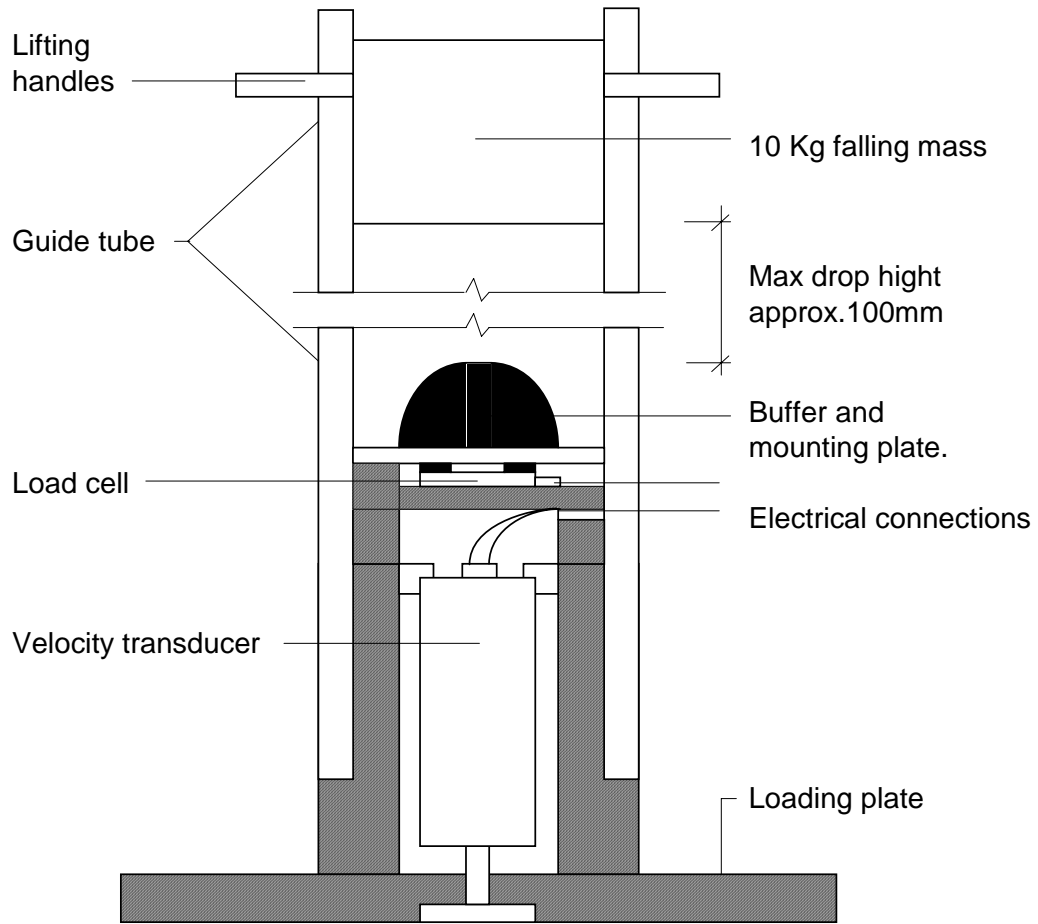

Figure 2. Schematic of the TRL Foundation Tester (TFT)

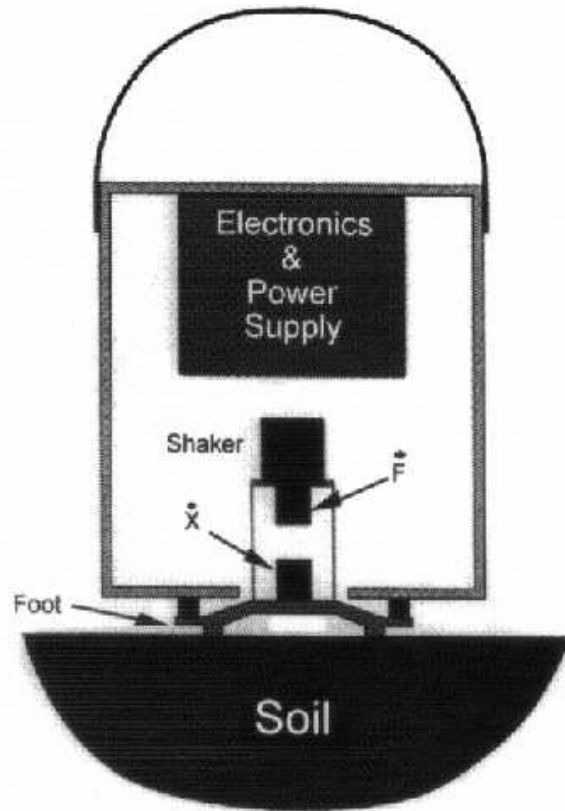

Figure 3. Schematic of the Humboldt Soil Stiffness Gauge.
 (Note: F and X denote the force and velocity transducer locations)

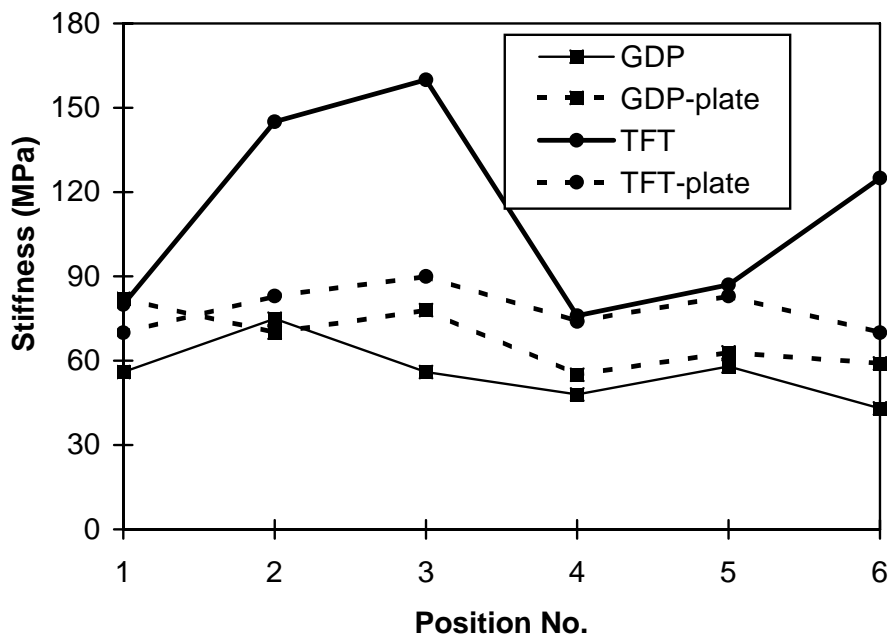

FIGURE 4 Effect of a 2nd Bearing Plate on Composite Stiffness Measurements for 550mm thick granular sub-base (Note: '-plate' = with 2nd bearing plate).

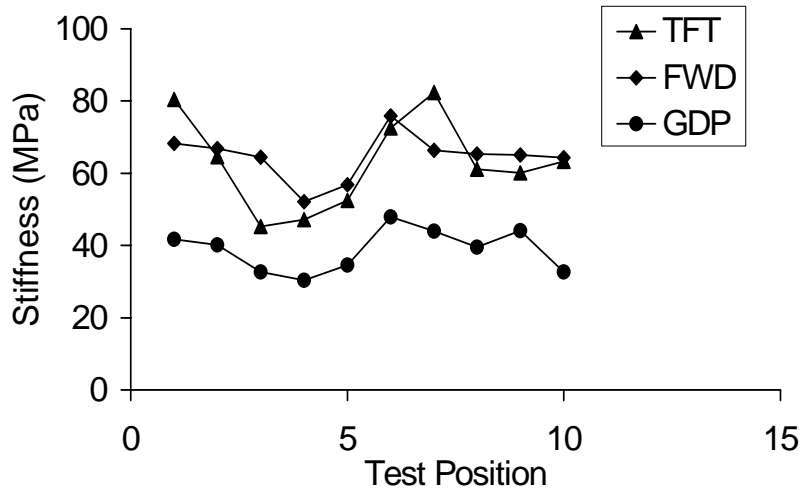

Figure 5. Variability of Stiffness Along a 20m Test Length (400mm Capping over Clay in Cutting)

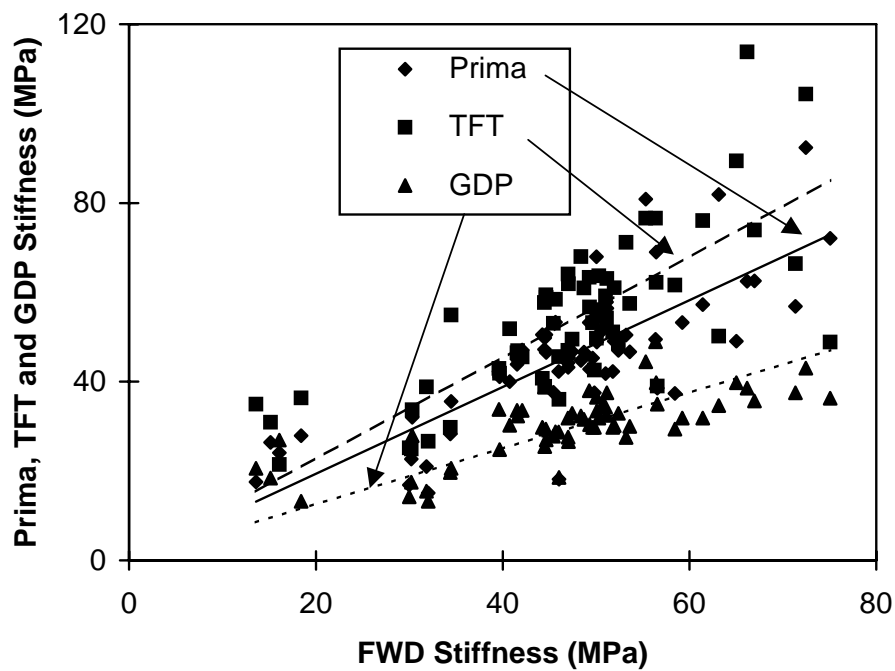

Figure 6. Relationship between Stiffness Modulus determined by the Portable Dynamic Plate Test Devices and the FWD (on subgrade and 400mm thick Granular Capping)

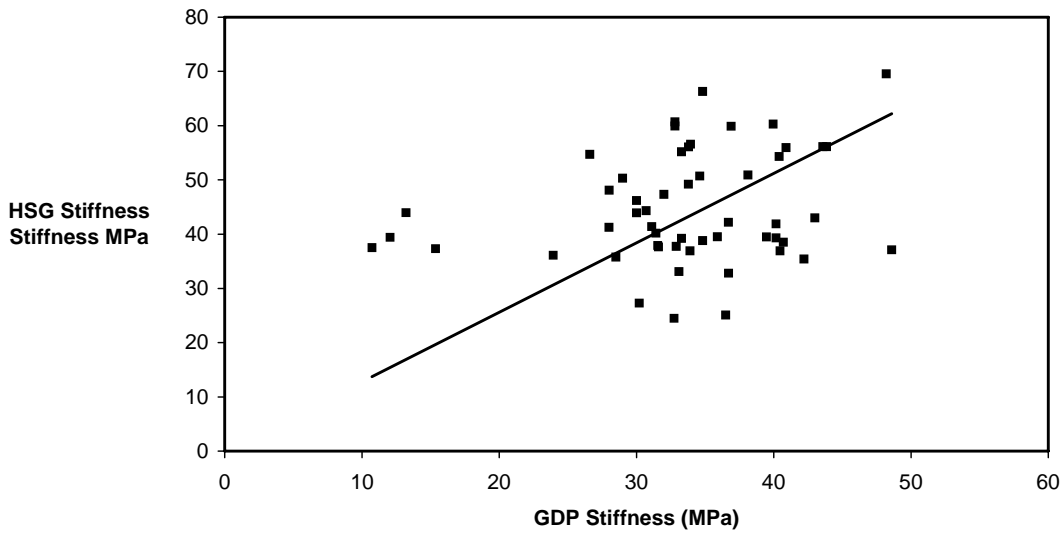

Figure 7. Relationship between the Humboldt Soil Stiffness Gauge and GDP
 (Note: from tests on granular type 1 sub-base in highway reinstements)

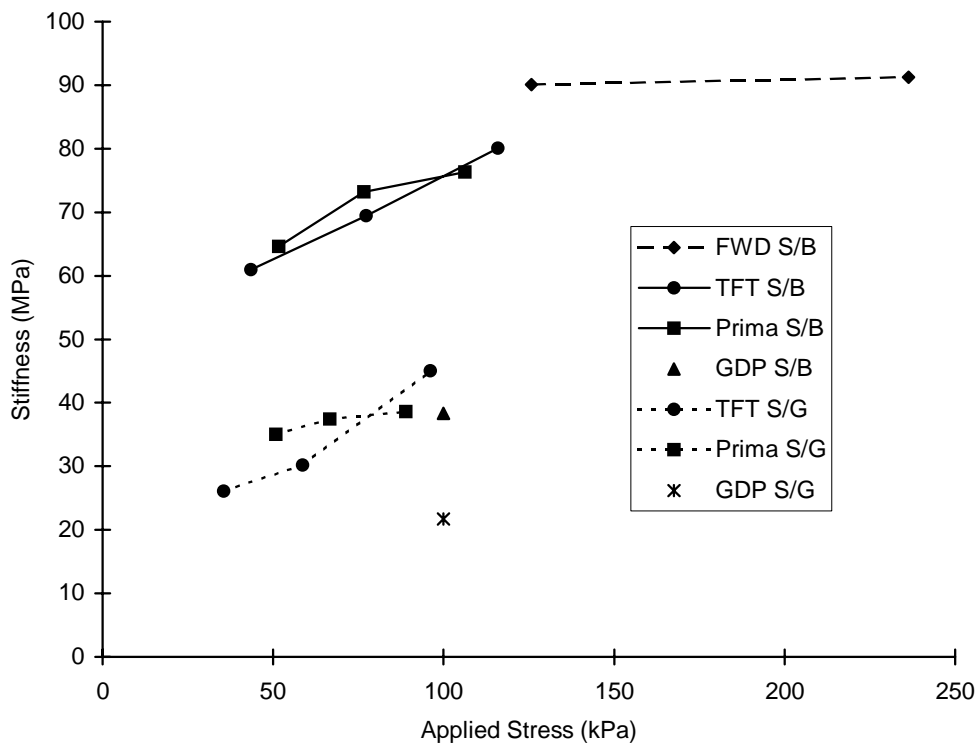

Figure 8. Relationship between Stiffness and Applied Stress for the FWD, TFT, Prima 100 and GDP on Sub-Base (S/B) and Subgrade (S/G) at a Controlled Trial Construction Site (400mm Capping and 150mm Sub-Base over a Clay Subgrade)