

This item was submitted to [Loughborough's Research Repository](#) by the author.
Items in Figshare are protected by copyright, with all rights reserved, unless otherwise indicated.

Block-control methods for low-order automotive control

PLEASE CITE THE PUBLISHED VERSION

PUBLISHER

© the authors

VERSION

AM (Accepted Manuscript)

LICENCE

CC BY-NC-ND 4.0

REPOSITORY RECORD

Ward, Christopher P., and A.T. Shenton. 2019. "Block-control Methods for Low-order Automotive Control".
figshare. <https://hdl.handle.net/2134/9747>.

This item was submitted to Loughborough's Institutional Repository (<https://dspace.lboro.ac.uk/>) by the author and is made available under the following Creative Commons Licence conditions.



CC creative commons
COMMONS DEED

Attribution-NonCommercial-NoDerivs 2.5

You are free:

- to copy, distribute, display, and perform the work

Under the following conditions:

BY: **Attribution.** You must attribute the work in the manner specified by the author or licensor.

Noncommercial. You may not use this work for commercial purposes.

No Derivative Works. You may not alter, transform, or build upon this work.

- For any reuse or distribution, you must make clear to others the license terms of this work.
- Any of these conditions can be waived if you get permission from the copyright holder.

Your fair use and other rights are in no way affected by the above.

This is a human-readable summary of the [Legal Code \(the full license\)](#).

[Disclaimer](#) 

For the full text of this licence, please go to:
<http://creativecommons.org/licenses/by-nc-nd/2.5/>

Block-Control Methods for Low-Order Automotive Control

C. P. Ward* A. T. Shenton*

* *Department of Engineering, University of Liverpool, Liverpool, L69 3GH, UK (e-mail: shenton@liv.ac.uk).*

Abstract: Robust linear and nonlinear control is a continuing requirement for automotive powertrain controls. Newton iteration techniques have been proposed for both nonparametric linear and recently nonlinear control. Such nonparametric methods may eventually allow benefits of both low-order controllers and more rapid calibration time. This paper evaluates the feasibility of such Newton iteration techniques by an experimental comparison of a standard Riccati method a Riccati J-spectral factorisation and a novel l_2 algebraic J-spectral factorisation using Newton iteration techniques in a SI engine idle controller. The methods are each applied in a 2-block H_∞ formulation. The results of experimentally implementing robust idle speed controllers show broadly similar outcomes for all the methods compared and thus indicate the potential of the Newton iteration methods for further development in more advanced nonparametric, low-order and nonlinear control.

Keywords: H_∞ block formation, Newton iterations, J-spectral factorisation, mixed sensitivity, idle speed control.

1. INTRODUCTION

Robust linear and nonlinear control is a continuing requirement for automotive powertrain controls, due to significant plant uncertainties arising from the complexity of the mechanical and combustion processes. An outstanding problem in this category is the rapid calibration of robust high-performance idle-speed controllers. Newton iteration techniques have been proposed for both nonparametric linear and recently nonlinear control. Such methods may eventually allow benefits of both low-order controllers and the more rapid calibration time.

This paper employs three linear controller design techniques based upon the two block robust control formation. Two of these are J-spectral factorisation methods. These allow free choice of the dissipation operator Q independent of the design procedure and possibly in-situ for on-line tuning. The first J-Spectral factorisation technique uses the discrete Riccati equation of W.Kongprawechnon and H.Kimura [1996] and Y.S.Hung and Chu [1998]. The second is a Newton iteration linear J-spectral factorisation technique that is an algebraic implementation of the approach proposed in A.T.Shenton [2007].

The idle-speed experimental setup is a Ford 1.6litre spark ignition (SI), port fuel injection (PFI) engine attached to a low inertia dynamometer. Signals and control are provided by a combination of a bespoke powerstage, Matlab-Simulink and a dSPACE Autobox. A mixed sensitivity design and application exercise proves very similar for all three techniques in terms of time response, controller usage and robustness. The results thus indicate the potential of such Newton iteration methods for development in more advanced nonparametric, low-order and nonlinear control.

1.1 Block Formulation

2. BLOCK FORMATION

The two block structure problem of robust control J.C. Doyle and Francis [1989]K. Zhou and Glover [1996]Skogestad and Postlethwaite [2001] is known to be a very general formulation for robust control. It is applicable across a wide range of uncertain systems and can encapsulate many dynamic performance requirements.

Through the paper a system is conveniently indicated by denoting its inputs as subscripts and outputs as superscripts. The problem is thus formulated in terms of the general forward augmented plant of figure 1. The plant dynamics (P) are augmented with suitably selected dynamic system weights (W_1, W_2, W_3) to bias the closed loop frequency response according to specific design goals. This allows design control over such requirements as response rate, damping, control effort, and both performance and stability robustness to uncertainties in the plant characteristics. The overall design objective is formulated as the minimisation of a norm cost function over the generalised disturbance inputs w to the controlled outputs z , using feedback from the measured output y , to determine the control signal applied to the input u .

This augmented formulation is embedded in the block formulation of figure 2(a). The targets for closed loop stability, performance, robustness tracking, control effort etc. are then cast in terms of system norms. Appropriate norm minimisation is then performed to produce controllers that achieve the system requirements. In particular the aim of the controller design process is to achieve dissipative characteristics from disturbance input w to controlled outputs z , so as to satisfy the signal norm inequality

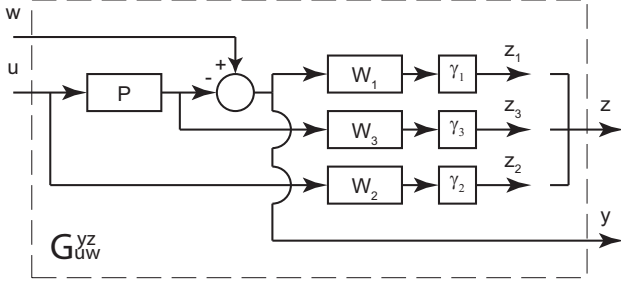

Fig. 1. Forward augmented plant formulation

$$\|z\|^2 < \|w\|^2 \quad (1)$$

by suitable choice of controller K_y^u of figure 2(a). In the technique of this paper this is performed by inverting the forward augmented plant G_{uw}^{yz} to produce K_{yz}^{uw} , also shown in figure 2(a). In the case that $G_{u,w}^{y,z}$ is square invertible and minimum-phase (MP) then $\|w'\|^2 \approx \|w\|^2$ and $\|z'\|^2 \approx \|z\|^2$ and thus

$$\|w\|^2 + \|z'\|^2 \approx \|w'\|^2 + \|z\|^2 \quad (2)$$

If a dissipative $Q_{w'}^{z'}, \|Q_{w'}^{z'}\|_{H_\infty} \leq 1$, is applied the dissipation inequality

$$\|z'\|^2 \leq \|w'\|^2 \quad (3)$$

is enforced and thus inequality 1 is satisfied and the block formulation of 2(a) is input-output stable (l_2 stable). In the case that $G_{u,w}^{y,z}$ is non-square (as in mixed sensitivity problems) or non-minimum phase (NMP) the required equivalent input-output energy properties can not be obtained by the inversion. In this case a square stable MP equivalent system $\hat{G}_{u,w}^{y,z}$ mapping from u and y to reduced dimension outputs \bar{w} and \bar{z} is accordingly sought through J-spectral factorisation so as to give the same energy transmission properties in the sense that $\|\bar{w}\|^2 \approx \|w\|^2$ and $\|\bar{z}\|^2 \approx \|z\|^2$ for the same inputs u and y .

This process is shown in figure 2(b). The first step is the creation of the first partial inverse G_{uy}^{wz} (system 2 in figure 2(b)), which can be achieved in this linear case through algebraic manipulation.

Because a specific element always contains a zero value the matrix is always singular and the required energy properties can not be obtained, a square system \hat{G}_{uy}^{wz} (system 3 in figure 2(b)), with no such zero terms which has the same energy transmission properties from u and y to w and z is accordingly sought through J-spectral factorisation. This can then be inverted to produce a second inverse $N_{w'z'}^{uy} = [\hat{G}_{uy}^{wz}]^{-1}$ (system 4 in figure 2(b)). If the composite system $I_{w'z'}^{wz} = G_{uy}^{wz} N_{w'z'}^{uy}$, formed from the composition of $N_{w'z'}^{uy}$ with G_{uy}^{wz} , (which forms the so called central controller) is stable, this guarantees the internal stability of the central controller, as shown in A.T.Shenton [2007].

The final step in the inversion procedure is then the algebraic manipulation of $N_{w'z'}^{uy}$ into the form of the final central controller K_{yz}^{uw} (system 5 in figure 2(b)). Freedom to choose Q independently from the design procedure is

an important degree of freedom not normally associated with the standard 2-Riccati equation method.

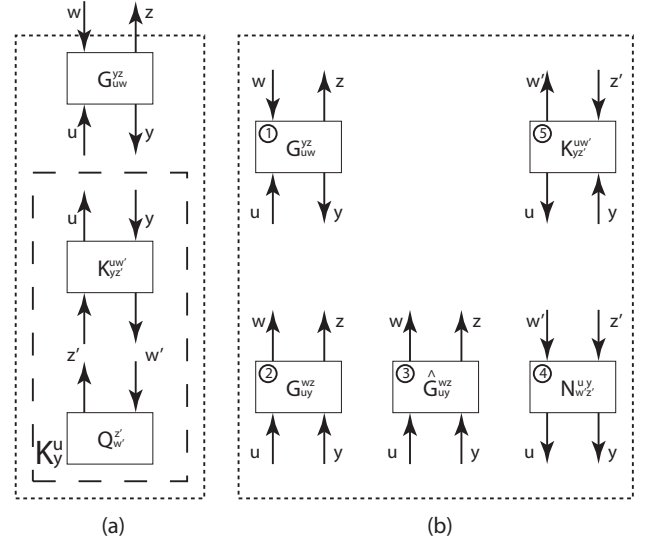

Fig. 2. (a):Block problem formulation,(b):Controller design path

2.1 The Linear J-Spectral Riccati

Two linear design procedures to implement the inverse procedure of the previous section are presented in this paper.

The first method is the discrete time procedure from W.Kongprawechnon and H.Kimura [1996] and Y.S.Hung and Chu [1998], solving J-spectral factorisation by a discrete Riccati equation.

The forward augmented system G_{uw}^{yz} (system 1 in figure 2(b)) is converted into the upwards system G_{uy}^{wz} (system 2 in figure 2(b)) by manipulation. This system is then considered in the packed state space form

$$G_{uy}^{wz}(z) = C(zI - A)^{-1}B + D = \begin{bmatrix} A & B \\ C & D \end{bmatrix} \quad (4)$$

The factorisation first requires the development of the discrete adjoint system, (superscript * denoting adjoint)

$$G_{uy}^{wz*}(z) = -B^T A^{-T} (zI - A^{-T})^{-1} A^{-T} C^T + (D^T - B^T A^{-T} C^T) \quad (5)$$

to solve the 2×2 E by a J-spectral factorisation of

$$G^*(-1)JG(-1) = E^T J^T E \quad (6)$$

by Newton iteration. The Riccati equation

$$\begin{aligned} & A^T X A + C^T J C \\ & - [A^T X B + C^T J D] [D^T J D + B^T X B]^{-1} \\ & [B^T X A + D^T J C] - X = 0 \end{aligned} \quad (7)$$

is then solved for the X such that $A + BF$ is stable with F of the form

$$F = -(D^T J D + B^T X B)^{-1} (D^T J C + B^T X A) \quad (8)$$

The stable factorised system \widehat{G}_{uy}^{wz} (system 3 in figure 2(b)) can now be found from

$$\widehat{G}_{uy}^{wz} = M^{-1} \begin{bmatrix} A & -B \\ F & I \end{bmatrix} \quad (9)$$

where

$$M = G_{\Pi}(-1)E^{-1} \quad (10)$$

and

$$G_{\Pi}(z) = \begin{bmatrix} A & B \\ -F & I \end{bmatrix} \quad (11)$$

The system is then inverted to produce the downwards system $N_{w'z'}^{uy}$ (system 4 in figure 2(b)). This is then coupled to the upward system \widehat{G}_{uy}^{wz} to produce the system $I_{w'z'}^{wz}$, stability of which guarantees the internal stability of the central controller. Once these conditions are satisfied the final central controller can now be produced in the form $K_{yz'}^{uw'}$ (system 5 in figure 2(b)). This format allows the user the freedom to choose an arbitrary form of Q , subject only to $|Q| < 1$, whilst guaranteeing that in the closed loop the relation of w to z is dissipative.

2.2 The l_2 Linear Newton Iteration Method

The following l_2 method proposed here is based on that in A.T.Shenton [2007] and Triantos [2006]. The technique follows the same path as the Riccati J-spectral factorisation technique, with a distinctly different method of performing the J-spectral factorisation.

Again the forward augmented system G_{uw}^{yz} (system 1 in figure 2(b)) is first converted into the upward form G_{uy}^{wz} (system 2 in figure 2(b)) by algebraic manipulation.

This is then factorised into the system \widehat{G}_{uy}^{wz} (system 3 in figure 2(b)). This is performed by an extension to the J-spectral case of the matricial polynomial I-spectral factorisation method due to Tunncliffe-Wilson [1969] Tunncliffe-Wilson [1972] and Vostry [1972]Vostry [1975] (see also V.Kucera [1979]), based upon Newton iterations, to obtain

$$G_{uy}^{*wz} J G_{uy}^{wz} = \beta = \widehat{G}_{uy}^{*wz} J \widehat{G}_{uy}^{wz} \quad (12)$$

with the iteration

$$2\beta = N_i^* J X_i + X_i^* J N_i \quad (13)$$

by solving for X_i , with N_i an arbitrarily chosen stable numerator matrix (i.e. an MP plant) initial point for the iteration. The Newton iteration for the subsequent factorisation is then

$$N_{i+1} = \frac{1}{2}(N_i + X_i). \quad (14)$$

The N_i is then placed back in equation 13, and the sequence is repeated. This continues until $N_i = X_i$. At this point $X_i = \widehat{G}_{uy}^{wz}$.

This process is polynomial only and hence requires a fixing of a common denominator. This has the advantage of fixing the system as stable and also guaranteeing the inverse $N_{w'z'}^{uy}$ is minimum phase. The process requires a heuristically chosen set of initial conditions for the factorisation

and does not guarantee convergence or minimum phase characteristics for any solution. Therefore a search procedure of initial conditions is performed where solutions are ranked on parameter convergence, energy convergence with the prefactorised system and minimum phase characteristics.

The solution of the factorised system the technique has the same structure as that of the Riccati J-spectral factorisation. The inverse $N_{w'z'}^{uy}$ can be thus obtained (system 4 in figure 2(b)) to check the stability of $I_{w'z'}^{wz}$, and then the final conversion to $K_{z'w'}^{uy}$ (system 5 in figure 2(b)).

3. THE ENGINE IDLE SPEED PROBLEM

The application of robust control theory to the engine idle speed problem has been examined extensively by many sources. The aim being to maintain a constant engine speed output (N), via application of the throttle, where the engine is subject to external loads. The application is used here as a means of comparing the new control theory examined in a stochastic environment. This paper draws direct comparisons between the standard 2-Riccati based solution using the Matlab Robust Control Toolbox, the linear Riccati J-spectral factorisation technique and the linear Newton-iteration technique.

3.1 Experimental Setup

The engine used is an SI, Ford Zetec 1.6l, 16 valve, four-stroke, four-cylinder, double overhead cam, port fuel injected IC engine. The engine is coupled via the flywheel to a 20kW low inertia dynamometer that reproduces the inertial effect of a gearbox internals and can also be used to provide loads direct to the crankshaft. Electrical loads that are typically experienced in the idle regime are applied via switching of various chassis electrical components which then load the crankshaft via the alternator. Hardware necessary to control the fuel timing and duration, air bypass valve (ABV) input and spark advance (SA) was developed in-house as a bespoke powerstage. This then allows direct control of variables via strategies compiled by Matlab-Simulink and Real-Time-Workshop, that are downloaded to a dSPACE Autobox unit.

3.2 The System Model

The design techniques require an applicable model of the controlled ABV input to engine speed output. The Ford engine control unit (ECU) was allowed control of the fuel strategy and SA was fixed at 27° , the ABV was perturbed using a pseudo random binary switch (PRBS) sequence and the corresponding data for N collected. An ordinary least squares identification was performed, with the provision that for use with the l_2 technique the transfer function must have the same size numerator and denominator, and that any time delay must be estimated through phase lag by allowing the system to be non-minimum phase. Several spot point model identifications were performed in the region of 700 to 1200 rpm with varying degrees of load, and due to the actuation of the ABV being independent of crank angle, with a constant sample time of $t_s = 0.03$, that relates approximately to 180° crank rotation at 1000rpm. The middle point model

from the set was selected for use in the controller design, equation 15.

$$G = \frac{10.87 - 29.05z^{-1} + 20.57z^{-2} + 3.555z^{-3}}{1 - 2.688z^{-1} + 2.416z^{-2} - 0.7263z^{-3}} \quad (15)$$

3.3 Controller Design

Three independent controller design techniques were employed on the identified dynamics of equation 15. The standard 2-Riccati equation approach from the Matlab Robust Control Toolbox, the Riccati J-spectral factorisation technique and the algebraic J-spectral factorisation technique. As outlined in Petridis [2000] the application will require a mixed sensitivity approach as the time response and control action usage constraints can not be achieved through a primary sensitivity constraint alone. The primary weighting was chosen to give good zero steady state tracking error and noise rejection characteristics.

$$W_1 = \frac{1.15 - 0.85z^{-1}}{1 - 0.9999z^{-1}} \gamma_1 \quad (16)$$

The control weighting was chosen to restrict the level of control action demanded across the entire frequency range and as such is a DC gain.

$$W_2 = \gamma_2 \quad (17)$$

The Bode plot of the forward augmented system $G_{u,w}^{y,z}$ is shown in figure 3 with $\gamma_1 = 0.2$ and $\gamma_2 = 300$.

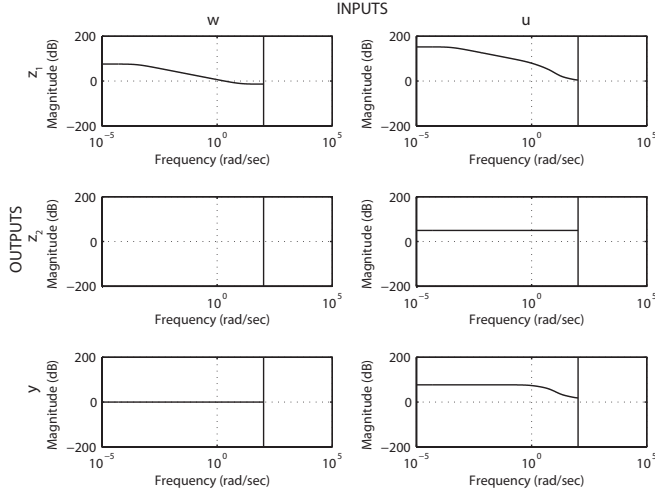

Fig. 3. Idle speed application augmented forward system Bode magnitude plot

The Standard Riccati Controller The Matlab robust control toolbox was employed to generate a H_∞ controller using the 2-Riccati equation technique. A suitable controller in terms of time response and control action was reached at $\gamma_1 = 0.2$ and $\gamma_2 = 300$. The closed loop displays a dissipative characteristic from the noise input w to the controlled output z . The controller state space realisation is equation A.1 in the appendix, with the dissipation characteristic in figure 4.

The J-Spectral Riccati Controller The first of the two block formation techniques was performed on the same problem and retaining the same level of weightings as the 2-Riccati technique for direct comparison. The central controller without application of Q is equation B.1 in the appendix. The closed loop dynamics again show the controller to be dissipative through the whole range of Q from 0 to 1, shown in figure 4. The time response is very similar to that of the 2-Riccati approach, with similar control action usage.

The Newton Iteration Controller The final controller technique for comparison is based on J-spectral factorisation by Newton iteration using a polynomial model. As with the previous method the level of the weightings was restricted to that of the 2-Riccati equation approach for direct comparison. The technique required a search of nearly five hundred initial conditions which were then ranked in terms of their applicability as outlined earlier, and the best selected. The central controller without Q as a fundamental component is equation C.1 in the appendix. The closed loop dynamics are once again dissipative through the range of Q in figure 4 and the time response is almost identical to that of the 2-Riccati and linear J-spectral Riccati designs.

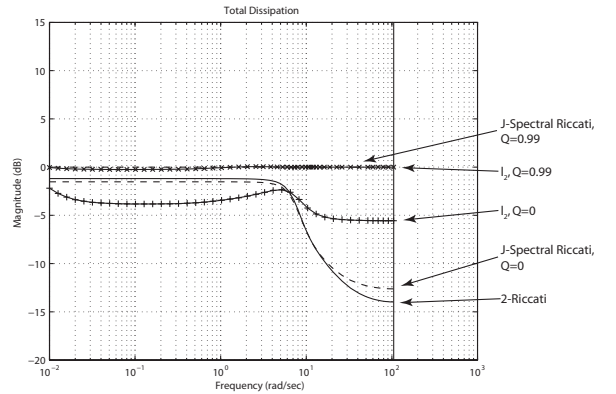

Fig. 4. Closed loop dissipation characteristics Bode magnitude plot

3.4 Experimental Controller Validation

Controller designs were validated back on the Ford Zetec 1.6litre engine setup. The designs were put through a series of repeatable tests to obtain an understanding of the robustness of the closed loop and the ability to cope with predicted loads. With a target idle speed of 900 rpm, the system was subject to a load that induced an approximately 200rpm drop in the idle speed.

Figure 5 shows the time response for the Riccati J-spectral factorisation technique with the Q parameter tuned on line. It shows that when $Q = 0$ the controller allows the lowest dip in the idle speed due to the crankshaft load increasing, with an approximate deviation of $-160rpm$ and the lowest amount of control action at 0.09 ABV duty. As the Q value is increased to nearly unity this speed deviation increases to $-200rpm$ and the control action increases to 0.13 ABV duty. The recovery time remains fairly constant through the variations in Q .

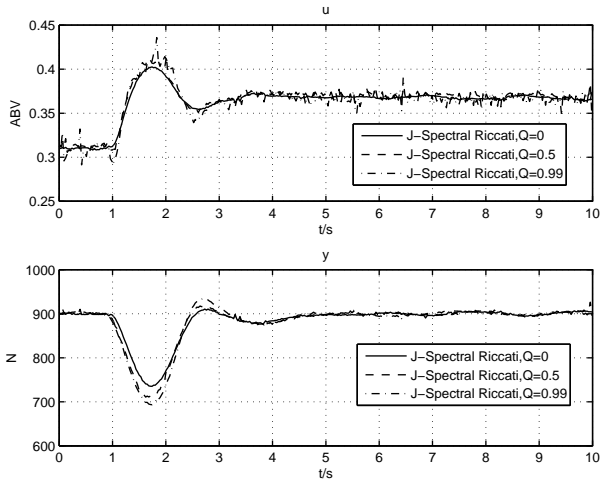

Fig. 5. J-spectral Riccati engine time response with varying Q

A similar trend is shown for the Newton-iteration design technique in figure 6. Again the parameter Q was tuned on line, and the smallest speed deviation was experienced at $Q = 0$ of $-150rpm$, with a control demand of 0.1 ABV duty. This deviation again increased as the Q was increased towards unity, with a speed deviation of $-200rpm$ and a controller demand of 0.11 ABV duty. Again the time response remaining reasonably constant.

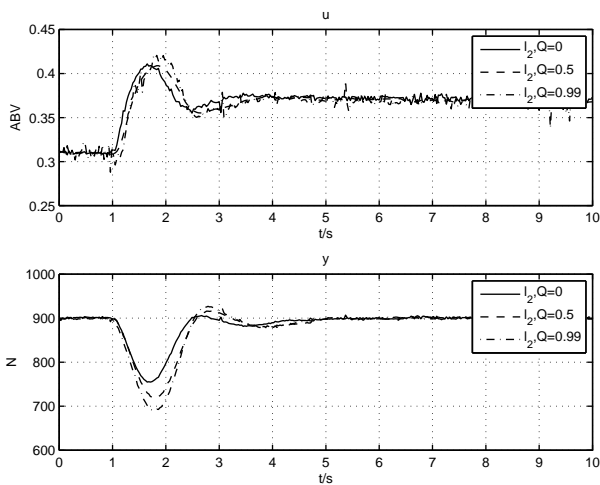

Fig. 6. Newton-iteration method engine time response with varying Q

Due to both the Riccati J-spectral factorisation and Newton-iteration techniques demonstrating their smallest speed deviation and controller usage at $Q = 0$ these have been compared with the standard 2-Riccati equation solution in figure 7. It can be seen that all three controllers exhibit a similar time response with the standard 2-Riccati experiencing the largest speed deviation and the Newton-iteration technique demonstrating the smallest deviation but requiring the largest degree of control action to recover.

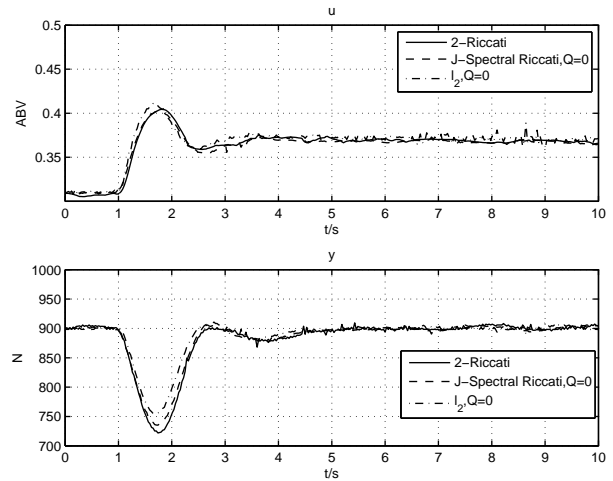

Fig. 7. Controller engine time response comparison

4. CONCLUSIONS

Three mixed-sensitivity H_∞ block problem control design techniques have been experimentally compared by application to the automotive SI engine idle speed control problem. In particular a J-spectral factorisation Newton iteration technique from A.T.Shenton [2007] using an algebraic polynomial formulation was compared with the standard Riccati method of J.C. Doyle and Francis [1989] and the discrete Riccati equation based J-spectral factorisation technique of W.Kongprawechnon and H.Kimura [1996] and Y.S.Hung and Chu [1998]. These methods gave very similar results in both simulation studies and the experimental outcome. The results thus indicate the potential of the Newton iteration methods for further development in more advanced nonparametric, low-order and nonlinear control.

REFERENCES

- A.T.Shenton. Narmax l_2 gain control: An approximate-inverse approach. *ECC2007, European Control Conference, Kos, Greece, July, 2007*.
- P.P. Khargonekar J.C. Doyle, K. Glover and B.A. Francis. *State-Space Solutions to Standard H_2 and H_∞ Control Problems*. *IEEE Trans. Automatic Control*, 34,8:831–847, 1989.
- J.C. Doyle K. Zhou and K. Glover. *Robust and Optimal Control*. Prentice Hall, 1996.
- A.P. Petridis. *Non-linear robust control of S.I. engines*. PhD Thesis, University of Liverpool, England, UK, 2000.
- Sigurd Skogestad and Ian Postlethwaite. *Multivariable Feedback Control*. John Wiley and Sons, 2001.
- G. Triantos. *NARMAX Modelling and Control With Powertrain Applications*. PhD Thesis, University of Liverpool, England, UK, 2006.
- G. Tunncliffe-Wilson. Factorization of the covariance generating function of a pure moving average process. *SIAM Journal of Numerical Analysis*, 6(1):1–7, 1969.
- G. Tunncliffe-Wilson. Factorization of the matrical spectral densities. *SIAM Journal of Applied Mathematics*, 23(4):420–426, 1972.

- V.Kucera. *Discrete Linear Control, The Polynomial Equation Approach*. Wiley-Interscience, 1979.
- Z. Vostry. A numerical method of matrix spectral factorization. *Kybernetika*, 8(5):448–470, 1972.
- Z. Vostry. New algorithm for polynomial spectral factorization with quadratic convergence. *Kybernetika-Volume II, Number 6*, pages 415–422, 1975.
- W.Kongprawechnon and H.Kimura. J-lossless conjugation and factorization for discrete-time systems. *International Journal of Control*, (Vol.65, No.5, p.867-884), 1996.
- Y.S.Hung and Delin Chu. (j,j’)-lossless factorization for discrete-time systems. *International Journal of Control*, (Vol.71, No.3, p.517-533), 1998.

Appendix A. THE STANDARD 2-RICCATI CONTROLLER

The standard 2-Riccati technique controller is

$$K_y^u = \left[\begin{array}{cccc|c} 0.6485 & -0.08855 & -0.05338 & 0.05725 & -0.03694 & 0.1085 \\ 0.2208 & 1.011 & 0.1724 & -0.3943 & 0.1703 & -1.299 \\ 0.1828 & 0.1393 & 0.9852 & 0.1412 & 0.09481 & -0.7673 \\ -0.07214 & 0.2066 & 0.1367 & 0.9421 & 0.2457 & 0.2327 \\ 0.2322 & -0.1355 & -0.1831 & 0.1996 & 0.7732 & 1.599 \\ \hline -0.0009692 & -0.0003718 & -0.0001958 & 0.000107 & -0.0001655 & 0.0001761 \end{array} \right] \quad (\text{A.1})$$

Appendix B. THE RICCATI J-SPECTRAL FACTORISATION CENTRAL CONTROLLER

The Riccati J-spectral factorisation central controller is

$$K_{zy}^{wu} = \left[\begin{array}{cccc|cc} 0.9295 & 0.277 & 0.06792 & -0.07953 & 0.004812 & 0.2204 \\ -0.5597 & 1.175 & 1.383 & 1.325 & -0.01366 & 0.02191 \\ 0.2274 & -0.4709 & 0.6074 & -0.1559 & -0.008412 & 0.1141 \\ -0.05503 & 0.4843 & -0.04515 & 0.6606 & -0.007289 & -0.02413 \\ \hline -1.984 & 0.4811 & 4.431 & 6.51 & 0.03613 & 0.9349 \\ 0.0187 & -0.009491 & -0.04225 & -0.04383 & -0.002832 & 0.0005049 \end{array} \right] \quad (\text{B.1})$$

Appendix C. THE NEWTON-ITERATION CENTRAL CONTROLLER

The Newton-iteration central controller is

$$K_{zy}^{wu} = \left[\begin{array}{c|c} A & B \\ \hline C & D \end{array} \right] \quad (\text{C.1})$$

where

$$A = \left[\begin{array}{cccccc} 0.8294 & -1.016 & 0.9946 & 1.319 & 0.4479 & -0.00202 & -0.04794 & 0.23 \\ -0.04626 & 0.8636 & -1.523 & -2.331 & 0.1156 & 0.1729 & 0.206 & 0.06 \\ -0.06305 & 0.1 & 0.8116 & 2.705 & 0.07227 & -0.1348 & -0.2764 & 0.02 \\ 0.00863 & -0.01074 & 0.002905 & 1.001 & -0.01402 & -0.006051 & 0.004368 & 0.007 \\ -0.2365 & -0.3008 & 1.873 & 2.438 & 1.457 & -0.01659 & -0.256 & 0.04 \\ 0.4874 & -0.4753 & -0.06747 & -8.075e^{-5} & -0.8248 & 0.6046 & 0.2571 & 1. \\ -0.1922 & 0.2332 & -0.1311 & -0.209 & 0.3203 & 0.1733 & 0.91 & -0.5 \\ 0.1932 & -0.2966 & 0.1314 & 0.2326 & -0.2987 & -0.08352 & 0.05829 & 0.6 \\ -0.01765 & 0.02543 & -0.01516 & -0.02468 & 0.02781 & 0.002879 & -0.002618 & 0.01 \end{array} \right]$$

$$B = \left[\begin{array}{cc} -0.01881 & 0.03722 \\ 0.02086 & -0.1474 \\ 0.001775 & 0.2918 \\ -0.002696 & 0.3565 \\ 0.0282 & 0.1128 \\ -0.00931 & -0.0291 \\ 0.0007197 & -0.03928 \\ -0.01539 & -0.0166 \\ -0.03302 & -0.03343 \end{array} \right] \quad (\text{C.3})$$

$$C = \left[\begin{array}{cccccc} 0.3388 & -0.4921 & -0.05451 & 0.2458 & -0.5043 & 0.1013 & 0.2217 & - \\ 0.002854 & -0.004095 & -0.0004541 & 0.0004834 & -0.004485 & -0.0007979 & 0.0009693 & - \end{array} \right]$$

$$D = \left[\begin{array}{cc} 0.4288 & -0.8448 \\ 0.002559 & 0.001547 \end{array} \right] \quad (\text{C.5})$$