

Model: ER; $p = 0.720786$; Rates: 0.843 SE: 0.387

■ No Caste
 Caste

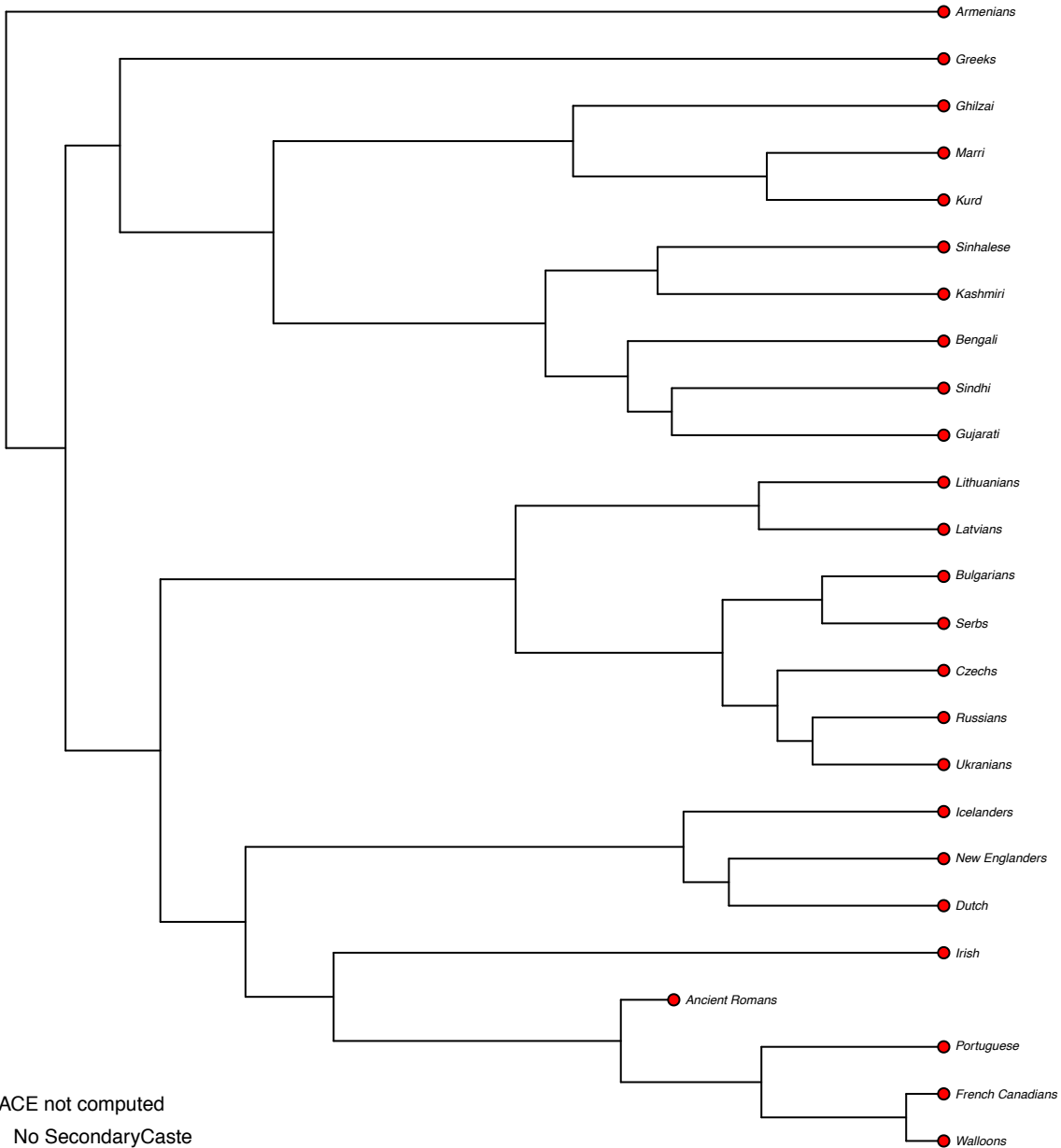

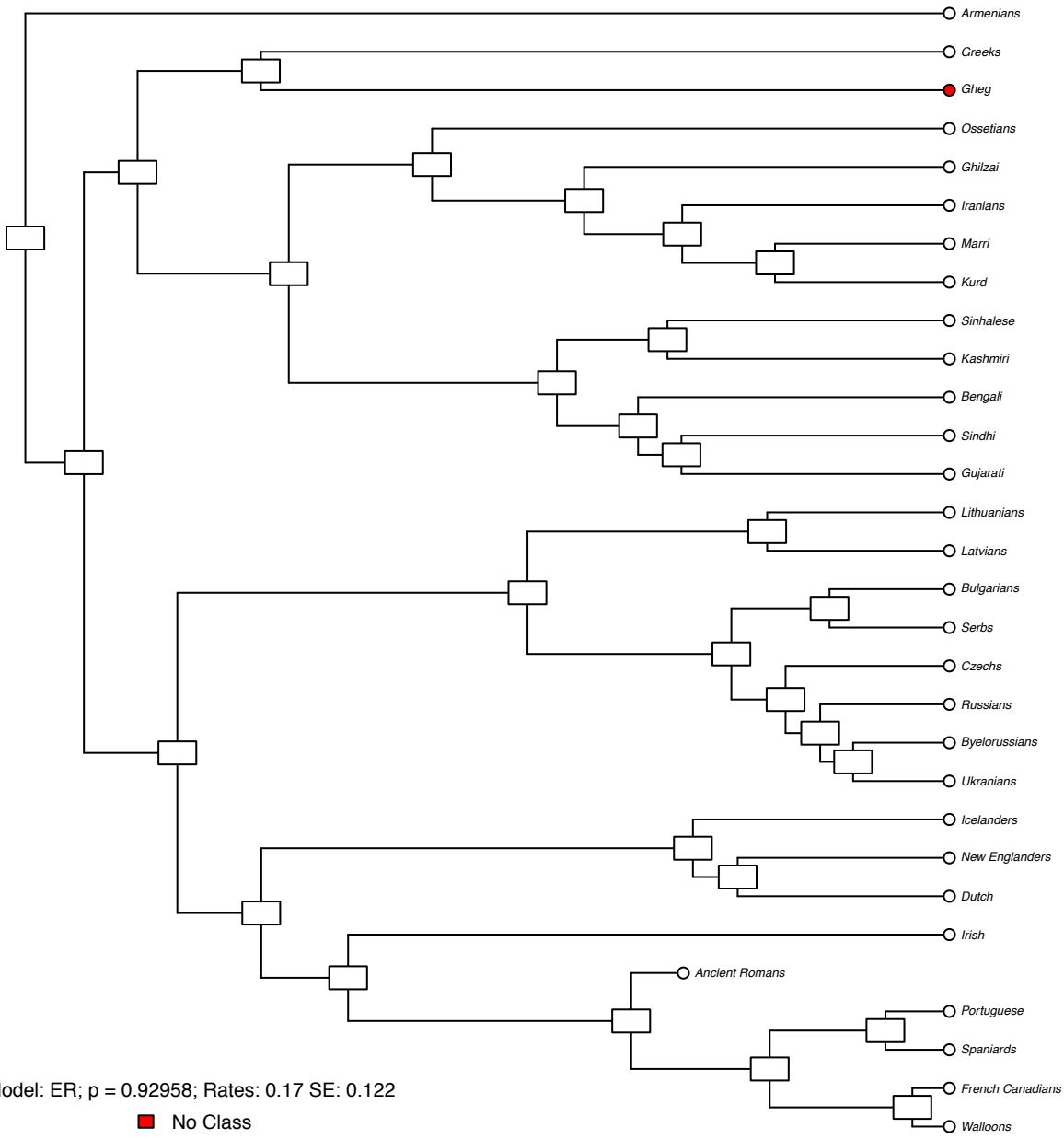

Model: ER; $p = 0.92958$; Rates: 0.17 SE: 0.122

■ No Class
 Class

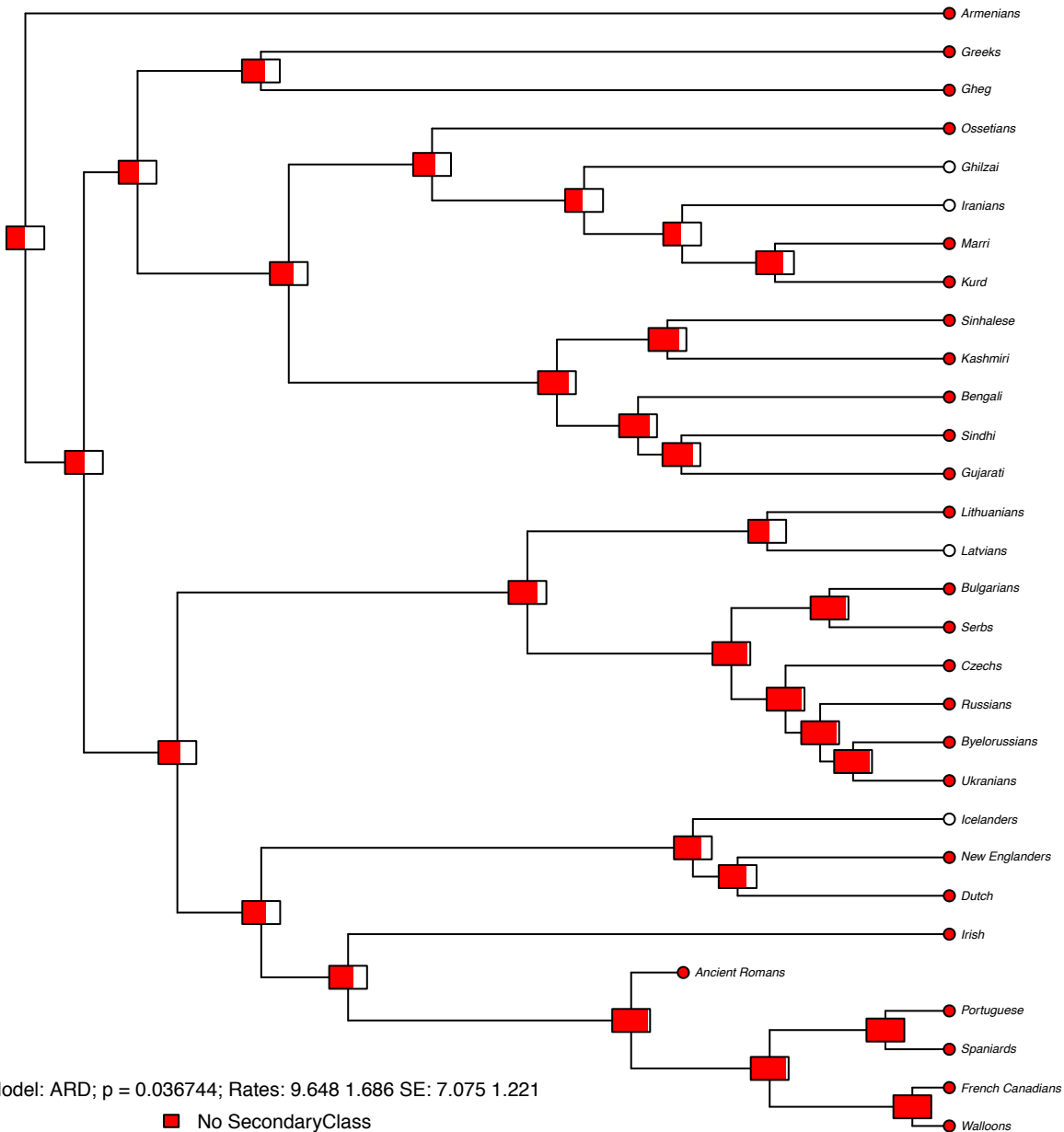

- Armenians
- Greeks
- Ghag
- Ossetians
- Ghilzai
- Iranians
- Marri
- Kurd
- Sinhalese
- Kashmiri
- Bengali
- Sindhi
- Gujarati
- Lithuanians
- Latvians
- Bulgarians
- Serbs
- Czechs
- Russians
- Byelorussians
- Ukrainians
- Icelanders
- New Englanders
- Dutch
- Irish
- Ancient Romans
- Portuguese
- Spaniards
- French Canadians
- Walloons

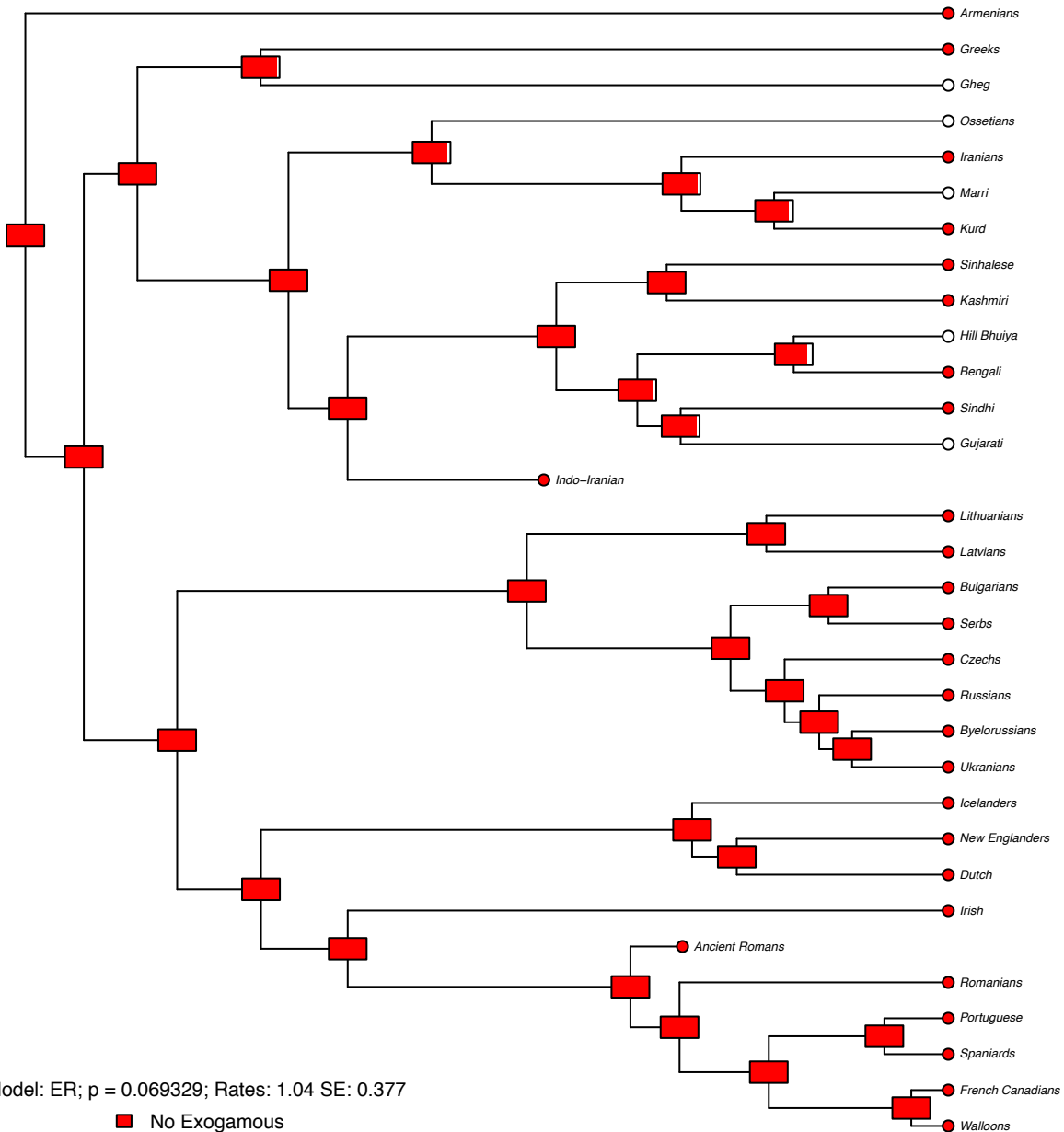

- Armenians
- Greeks
- Ghag
- Ossetians
- Iranians
- Marri
- Kurd
- Sinhalese
- Kashmiri
- Hill Bhuiya
- Bengali
- Sindhi
- Gujarati
- Indo-Iranian
- Lithuanians
- Latvians
- Bulgarians
- Serbs
- Czechs
- Russians
- Byelorussians
- Ukrainians
- Icelanders
- New Englanders
- Dutch
- Irish
- Ancient Romans
- Romanians
- Portuguese
- Spaniards
- French Canadians
- Walloons

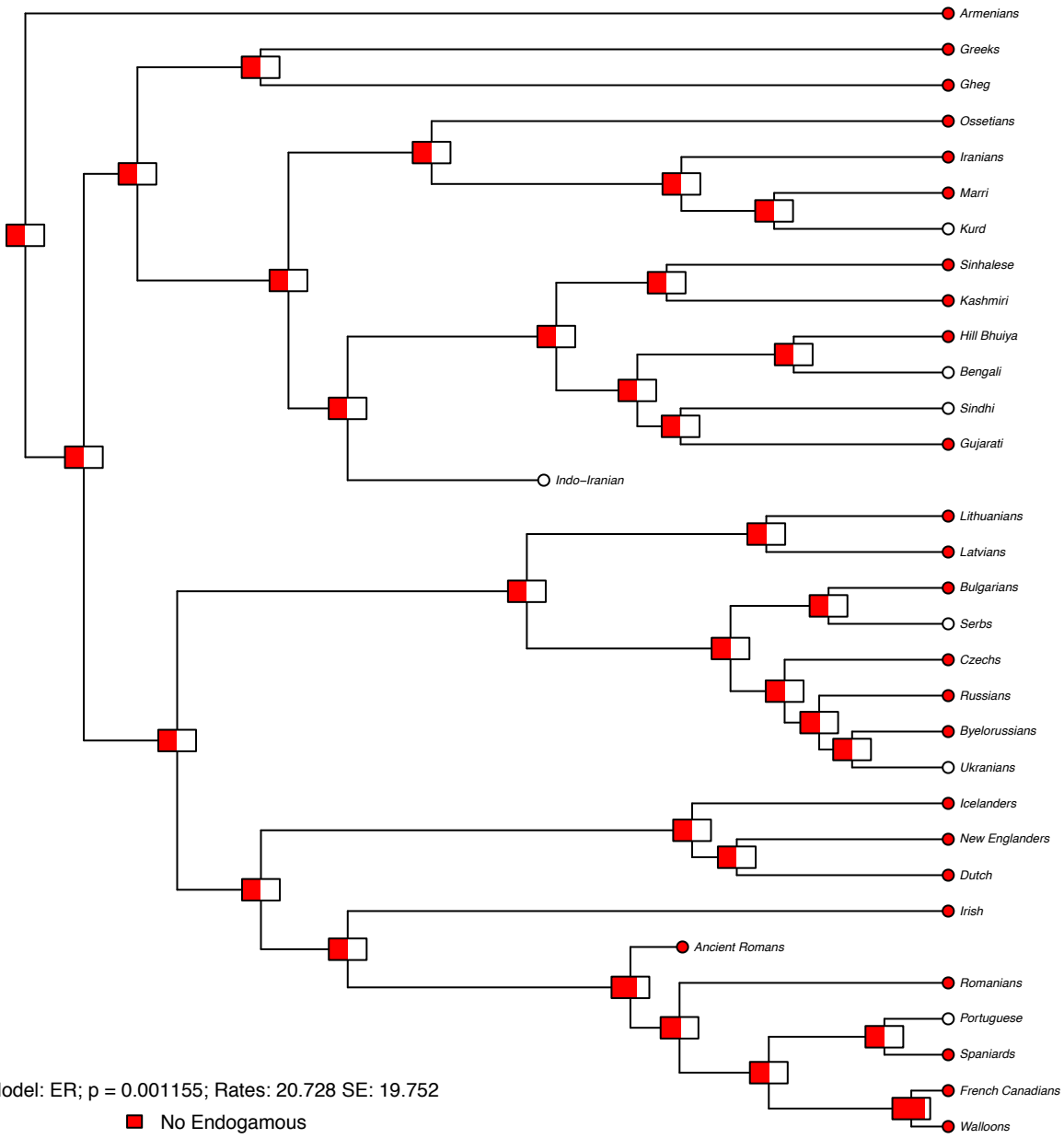

Model: ER; $p = 0.001155$; Rates: 20.728 SE: 19.752

■ No Endogamous
 □ Endogamous

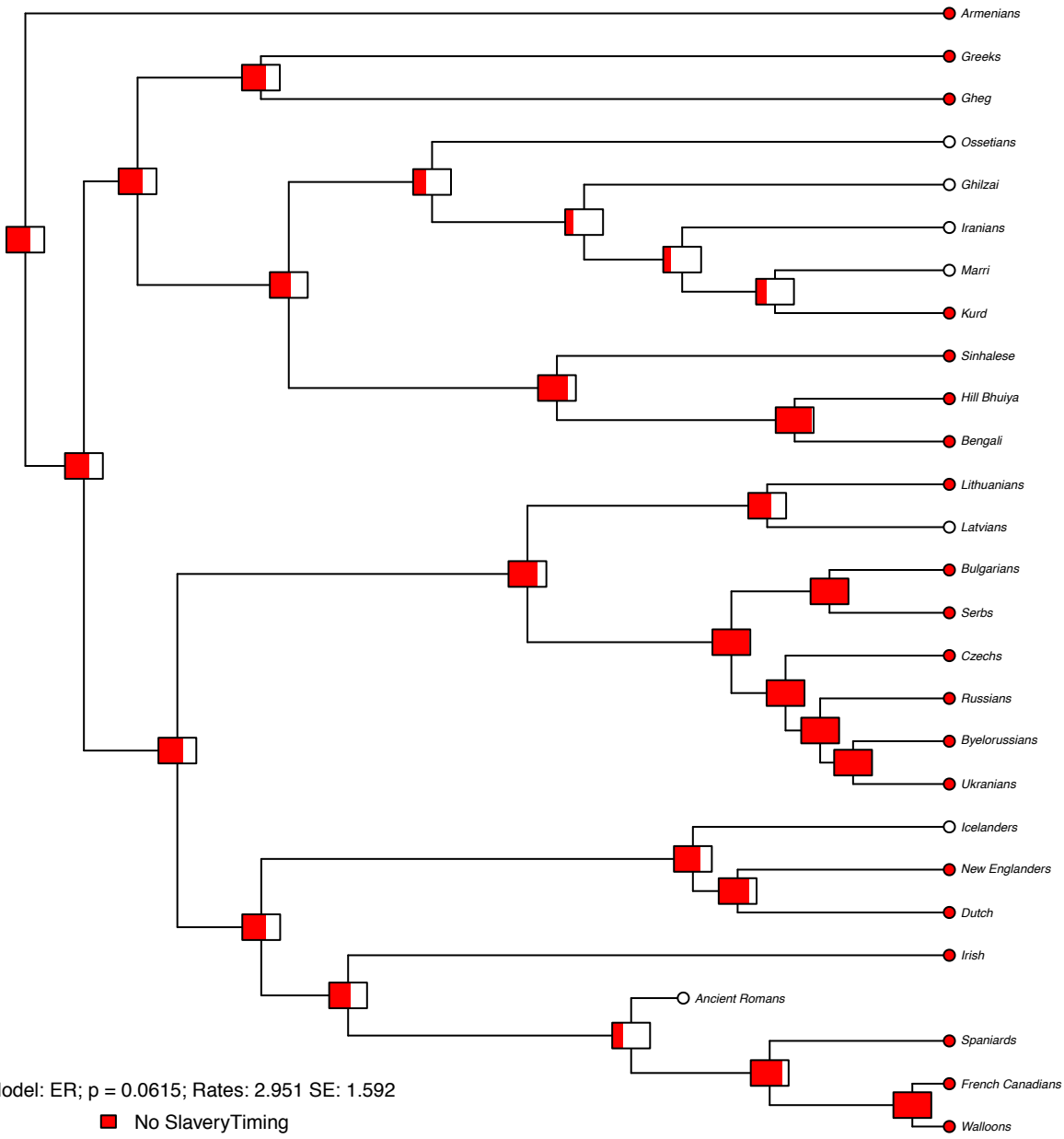

Model: ER; $p = 0.0615$; Rates: 2.951 SE: 1.592

- No SlaveryTiming
- SlaveryTiming

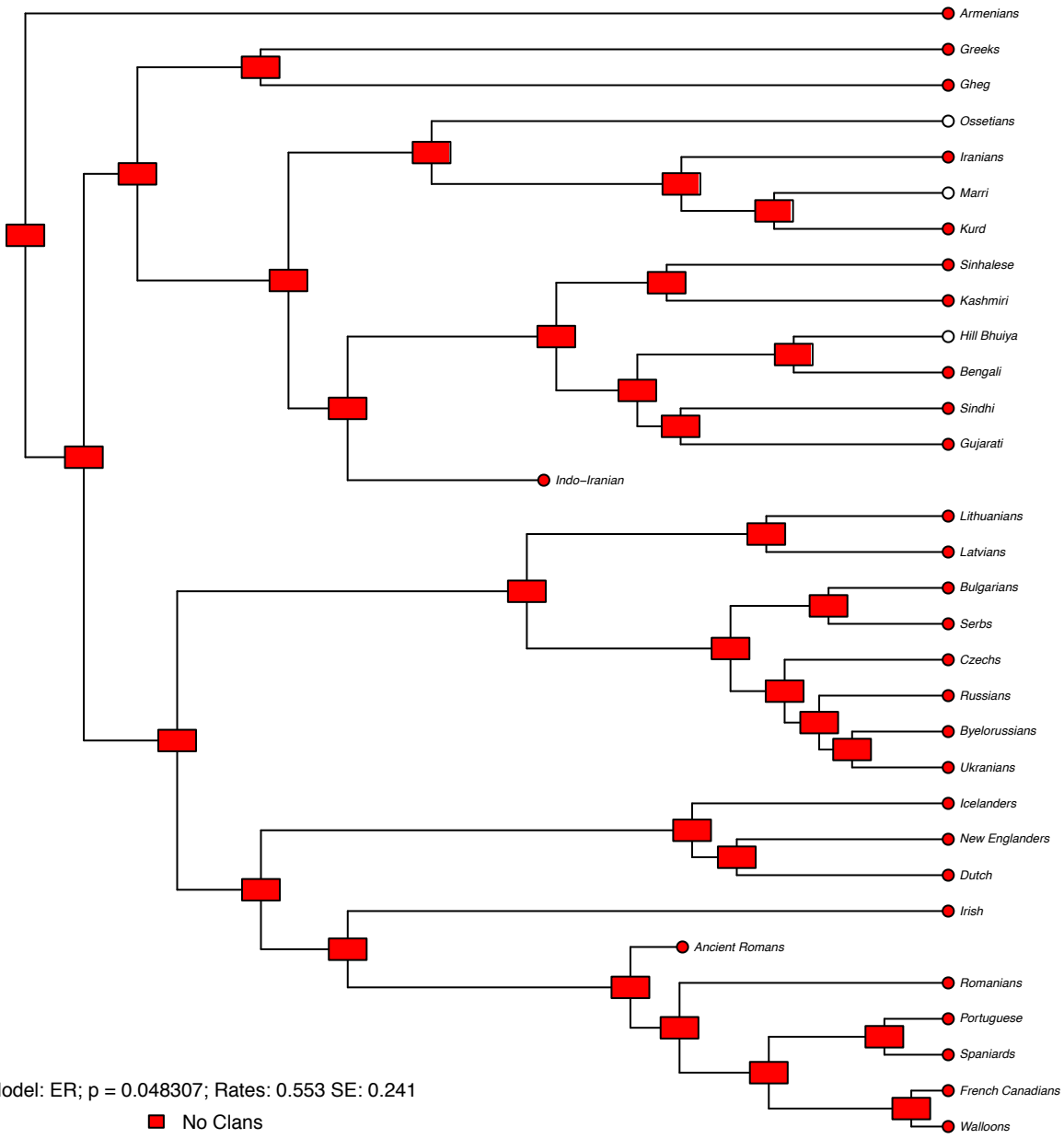

Model: ER; $p = 0.048307$; Rates: 0.553 SE: 0.241

- No Clans
- Clans

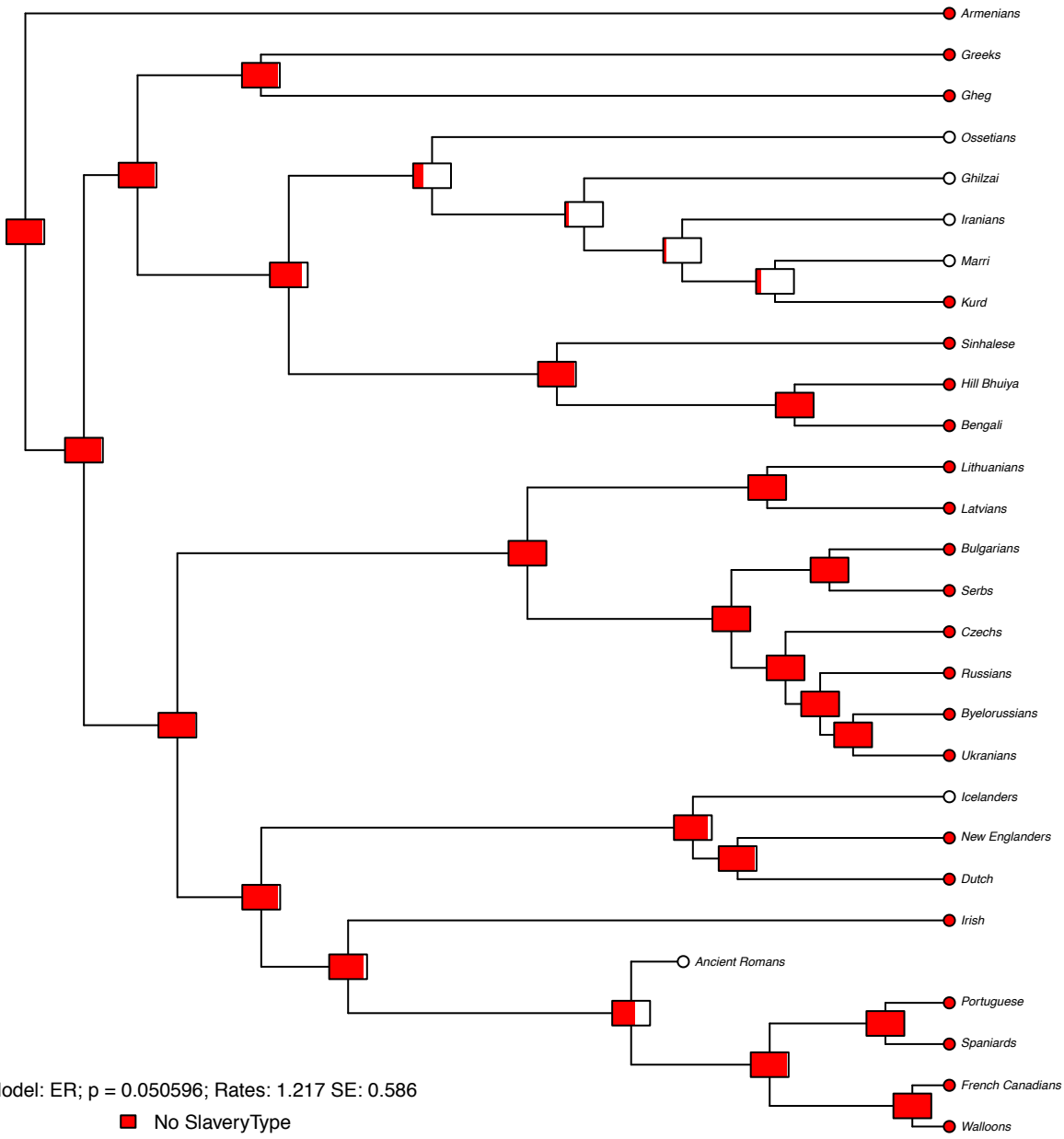

Model: ER; $p = 0.050596$; Rates: 1.217 SE: 0.586

■ No SlaveryType
 SlaveryType

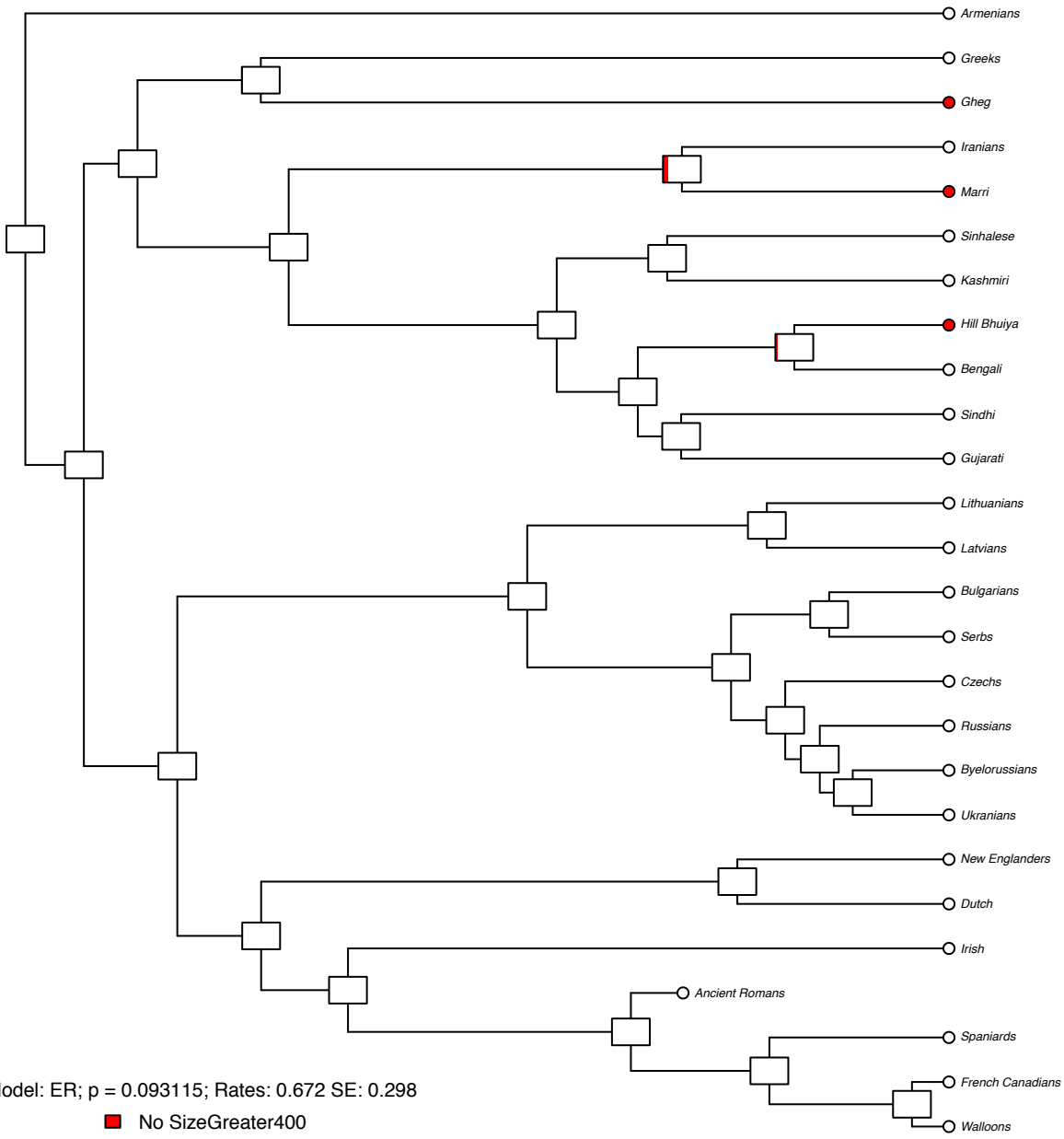

Model: ER; $p = 0.093115$; Rates: 0.672 SE: 0.298

■ No SizeGreater400
 SizeGreater400

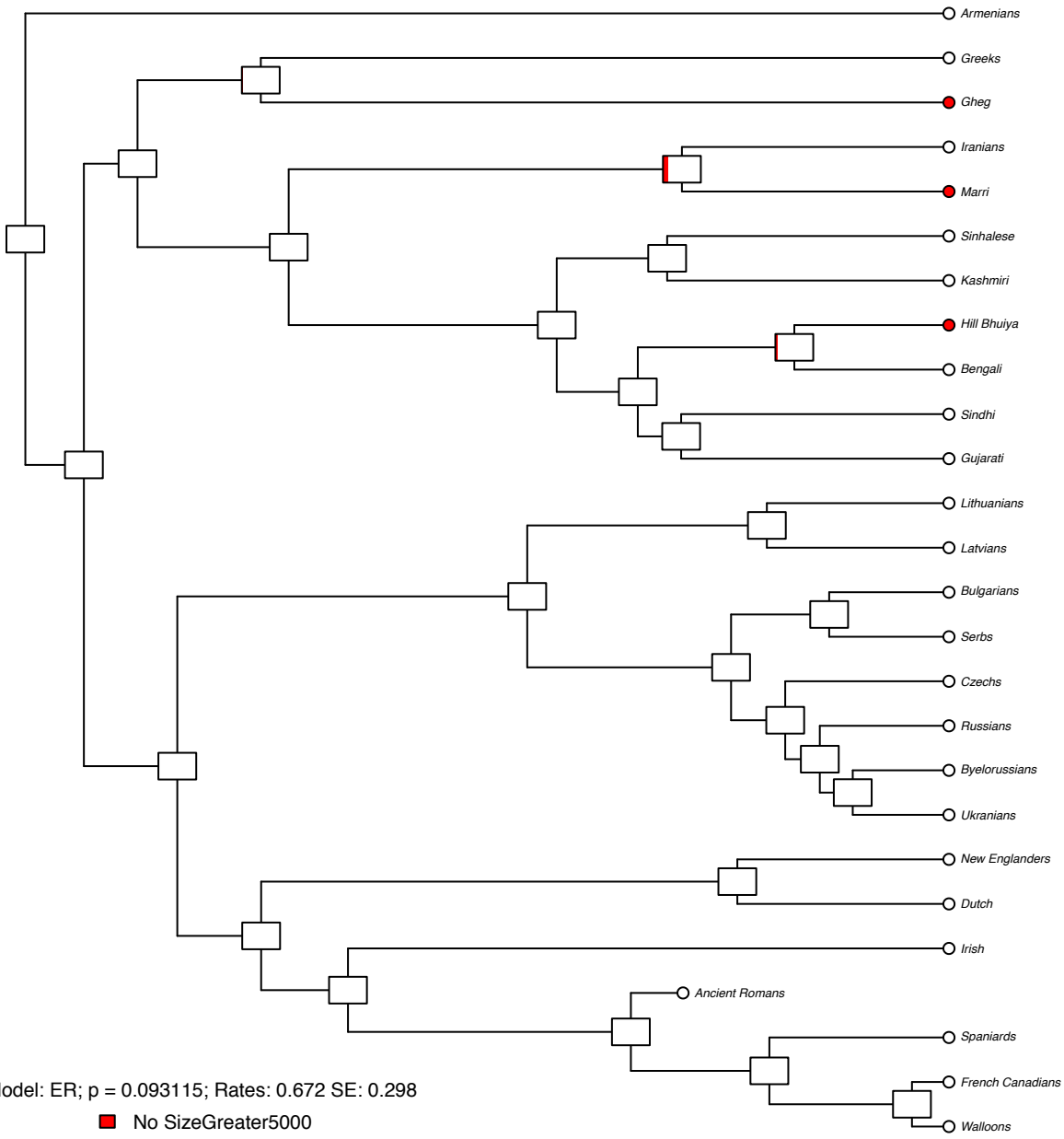

○ Armenians
 ○ Greeks
● Ghag
 ○ Iranians
● Marri
 ○ Sinhalese
 ○ Kashmiri
● Hill Bhuiya
 ○ Bengali
 ○ Sindhi
 ○ Gujarati
 ○ Lithuanians
 ○ Latvians
 ○ Bulgarians
 ○ Serbs
 ○ Czechs
 ○ Russians
 ○ Byelorussians
 ○ Ukrainians
 ○ New Englanders
 ○ Dutch
 ○ Irish
 ○ Ancient Romans
 ○ Spaniards
 ○ French Canadians
 ○ Wallons

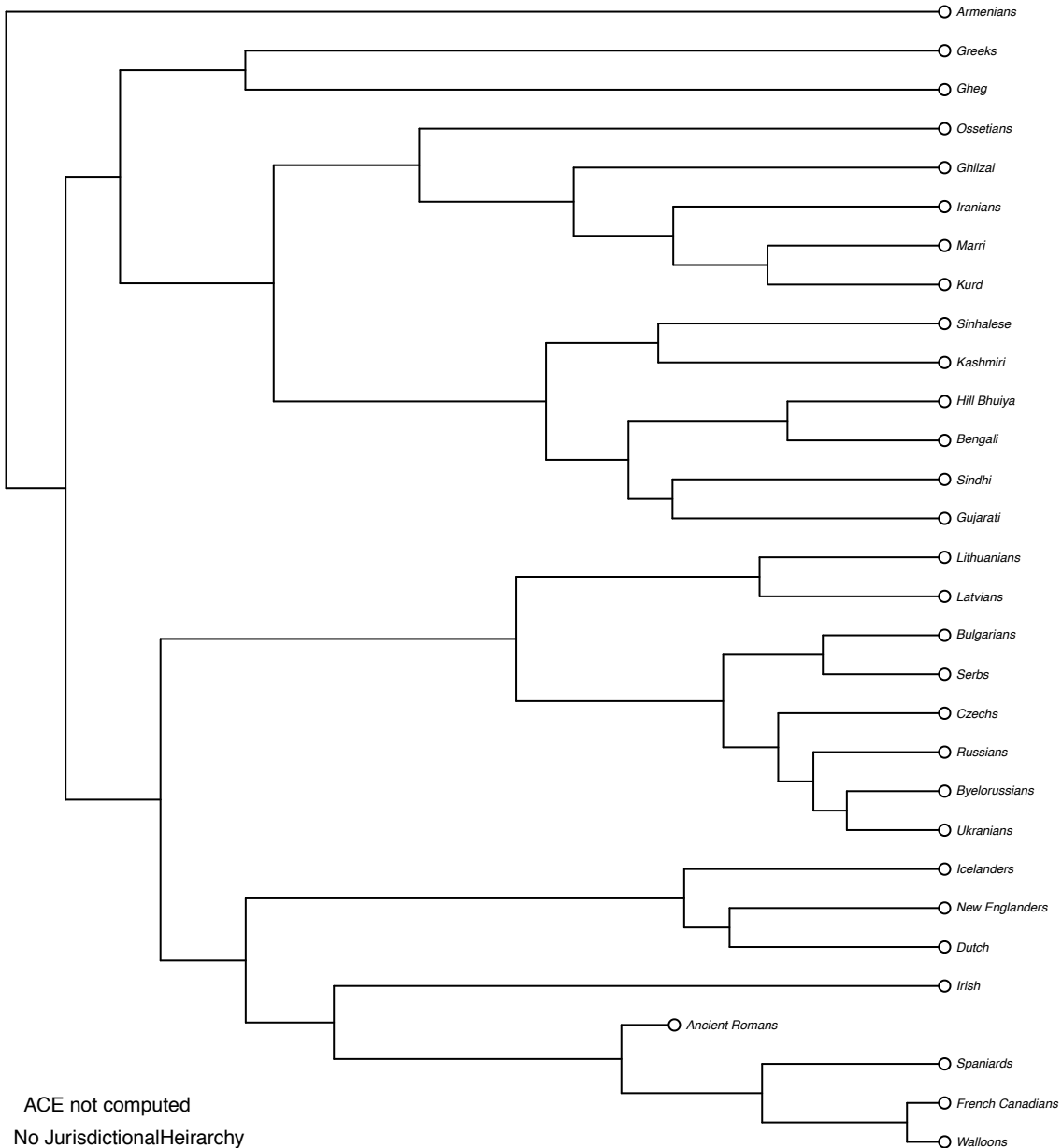

○ Armenians

○ Greeks

○ Ghag

○ Ossetians

○ Ghilzai

○ Iranians

○ Marri

○ Kurd

○ Sinhalese

○ Kashmiri

○ Hill Bhuiya

○ Bengali

○ Sindhi

○ Gujarati

○ Lithuanians

○ Latvians

○ Bulgarians

○ Serbs

○ Czechs

○ Russians

○ Byelorussians

○ Ukrainians

○ Icelanders

○ New Englanders

○ Dutch

○ Irish

○ Ancient Romans

○ Spaniards

○ French Canadians

○ Walloons

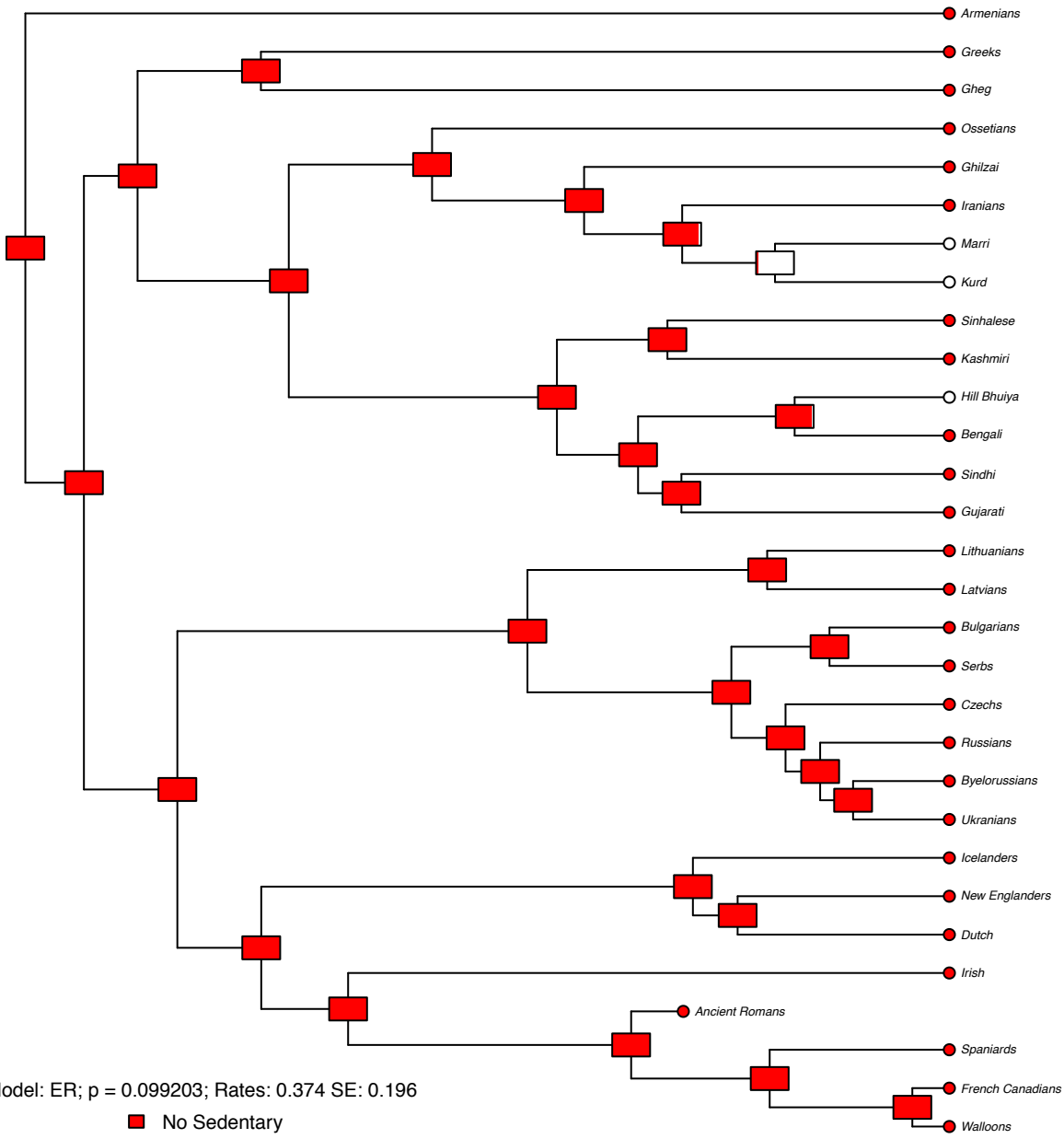

- Armenians
- Greeks
- Ghag
- Ossetians
- Ghilzai
- Iranians
- Marri
- Kurd
- Sinhalese
- Kashmiri
- Hill Bhuiya
- Bengali
- Sindhi
- Gujarati
- Lithuanians
- Latvians
- Bulgarians
- Serbs
- Czechs
- Russians
- Byelorussians
- Ukrainians
- Icelanders
- New Englanders
- Dutch
- Irish
- Ancient Romans
- Spaniards
- French Canadians
- Walloons

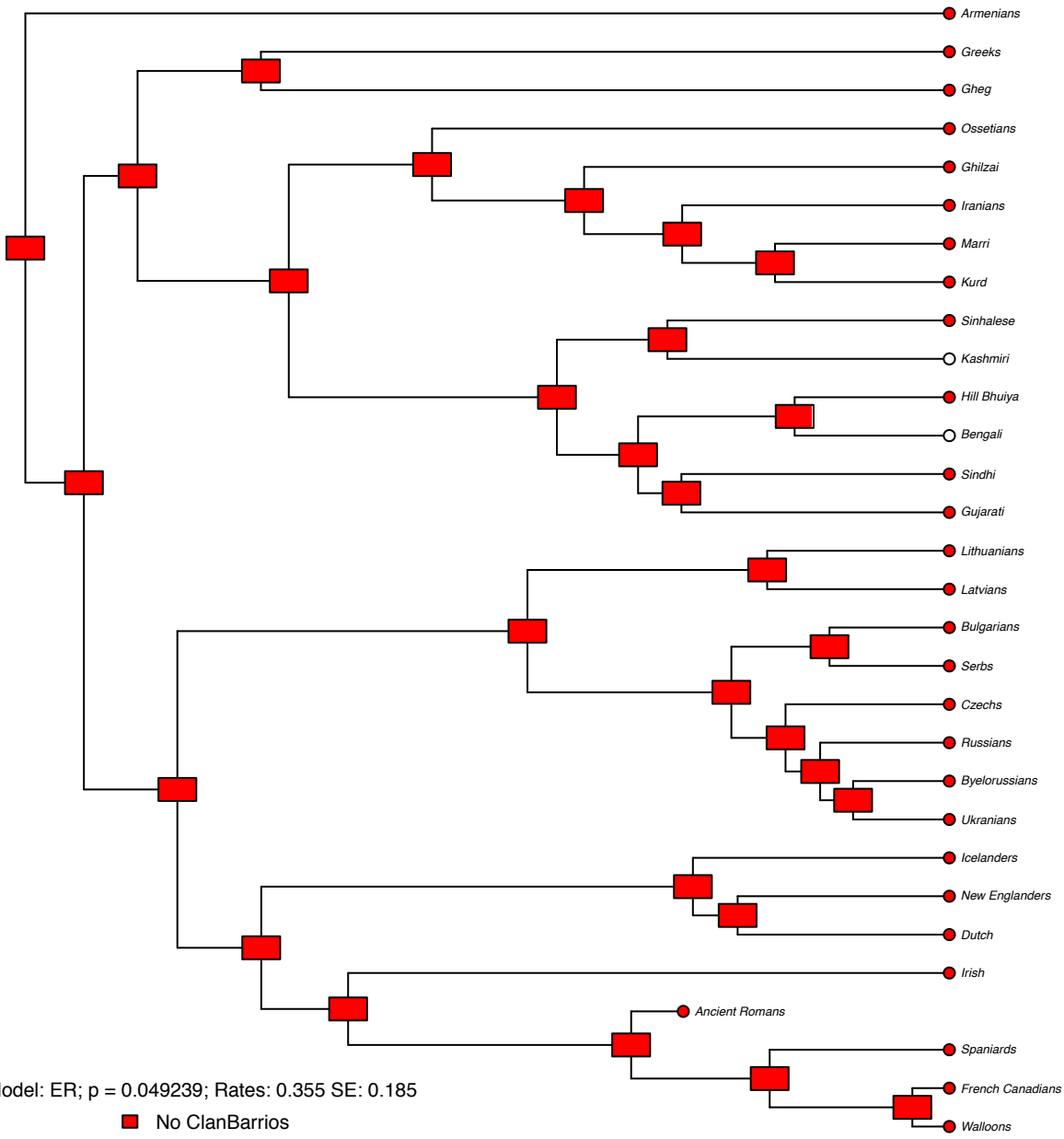

Model: ER; $p = 0.049239$; Rates: 0.355 SE: 0.185

- No ClanBarrios
- ClanBarrios

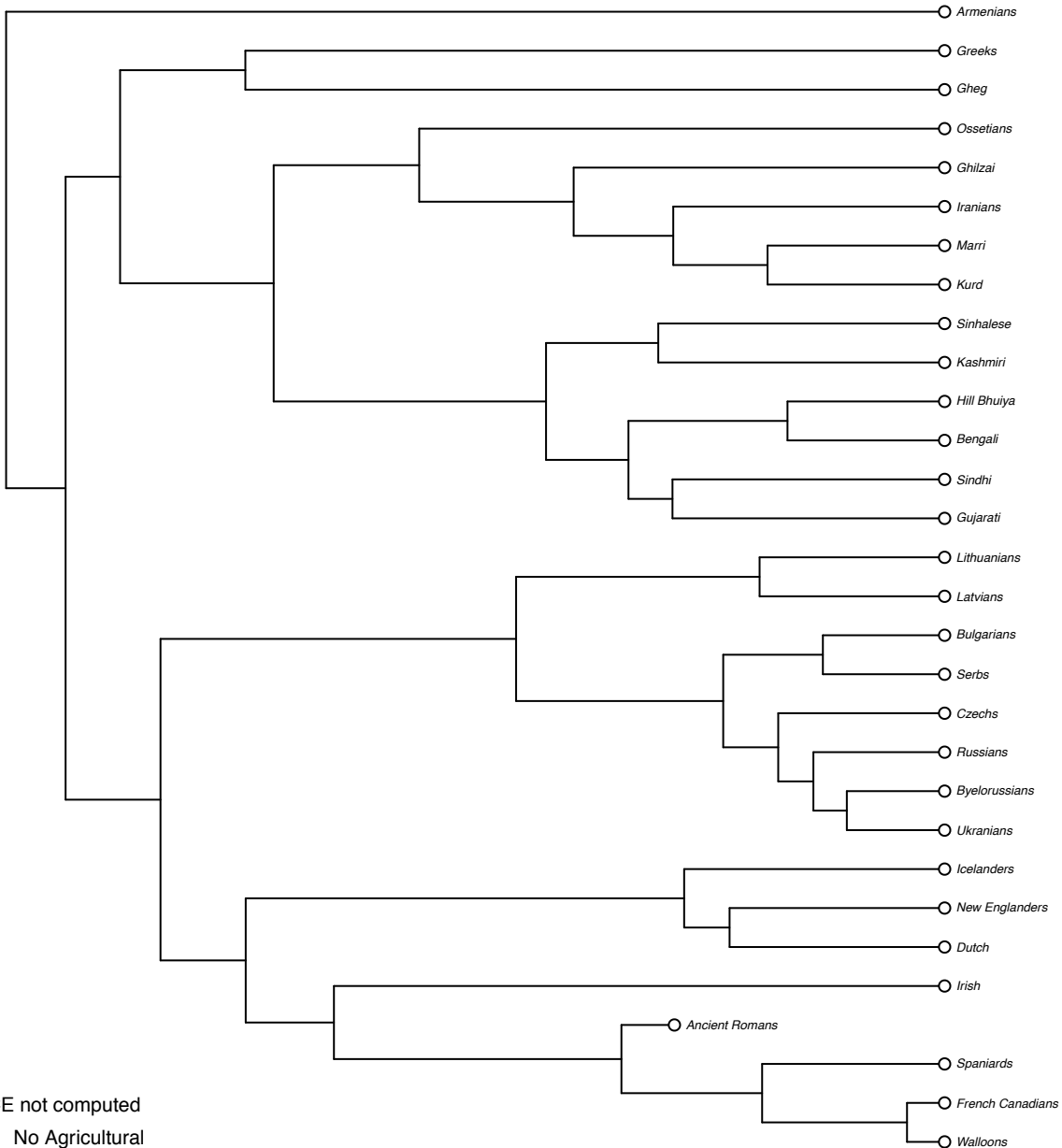

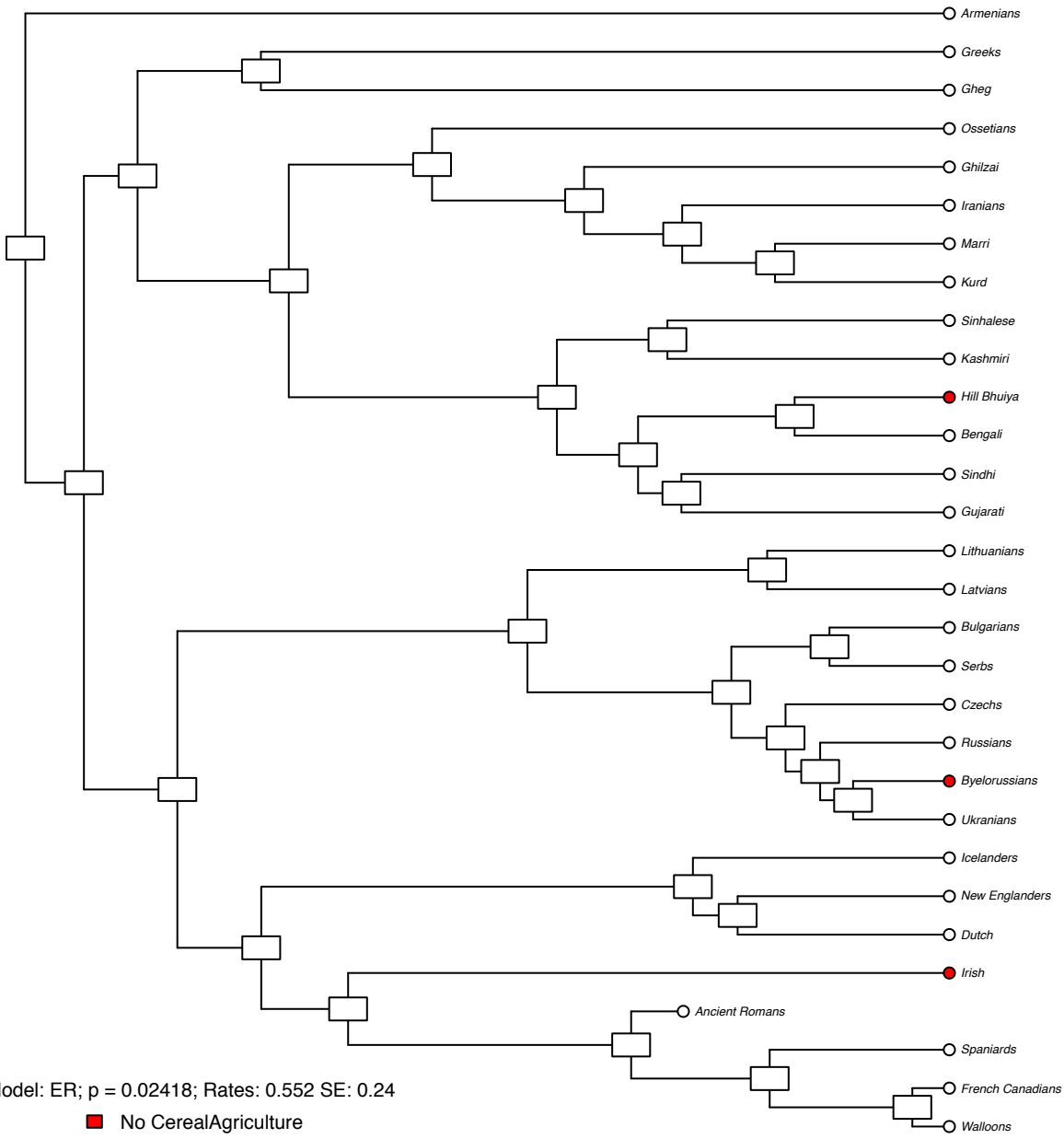

Model: ER; $p = 0.02418$; Rates: 0.552 SE: 0.24

- No CerealAgriculture
- CerealAgriculture

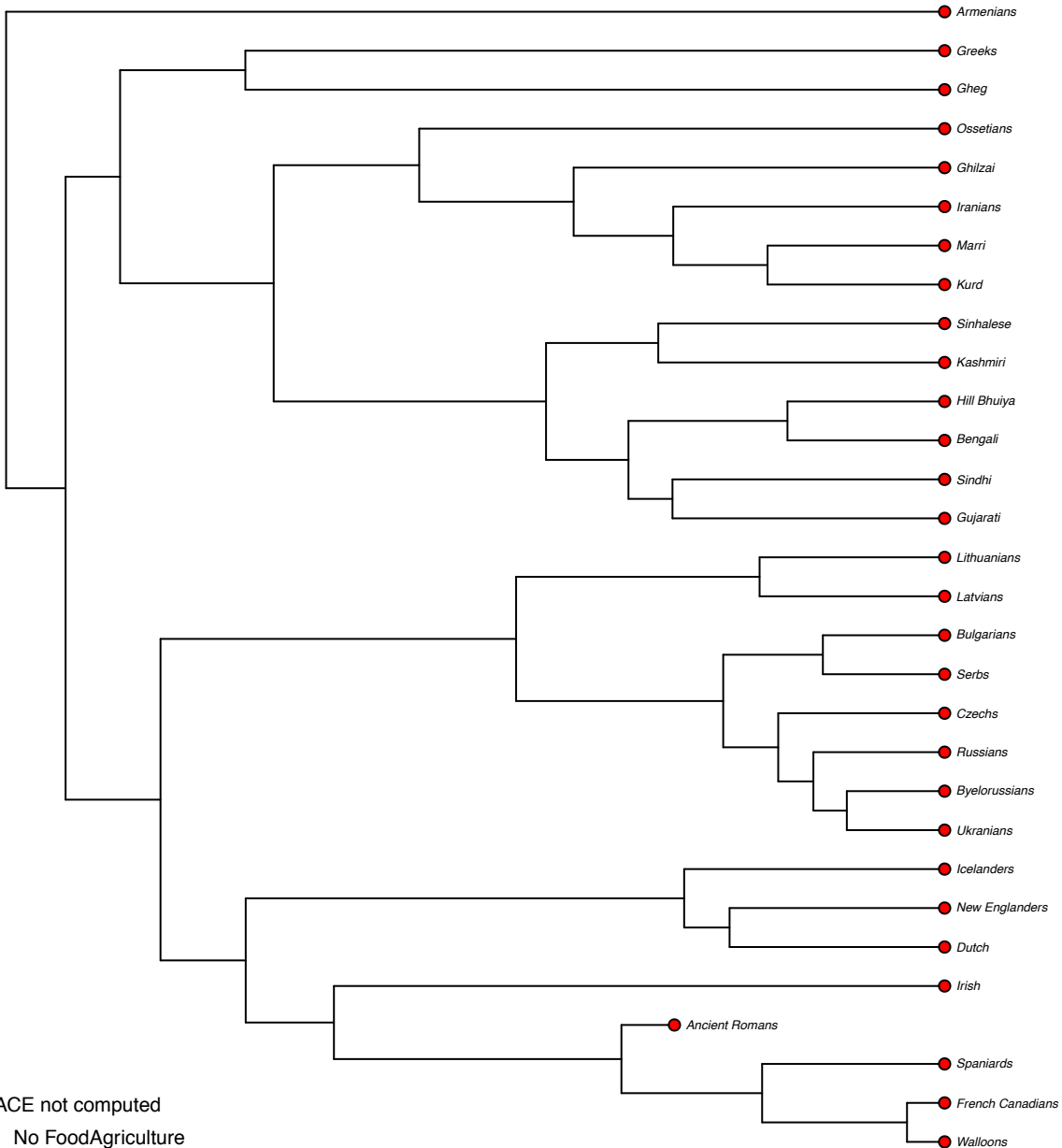

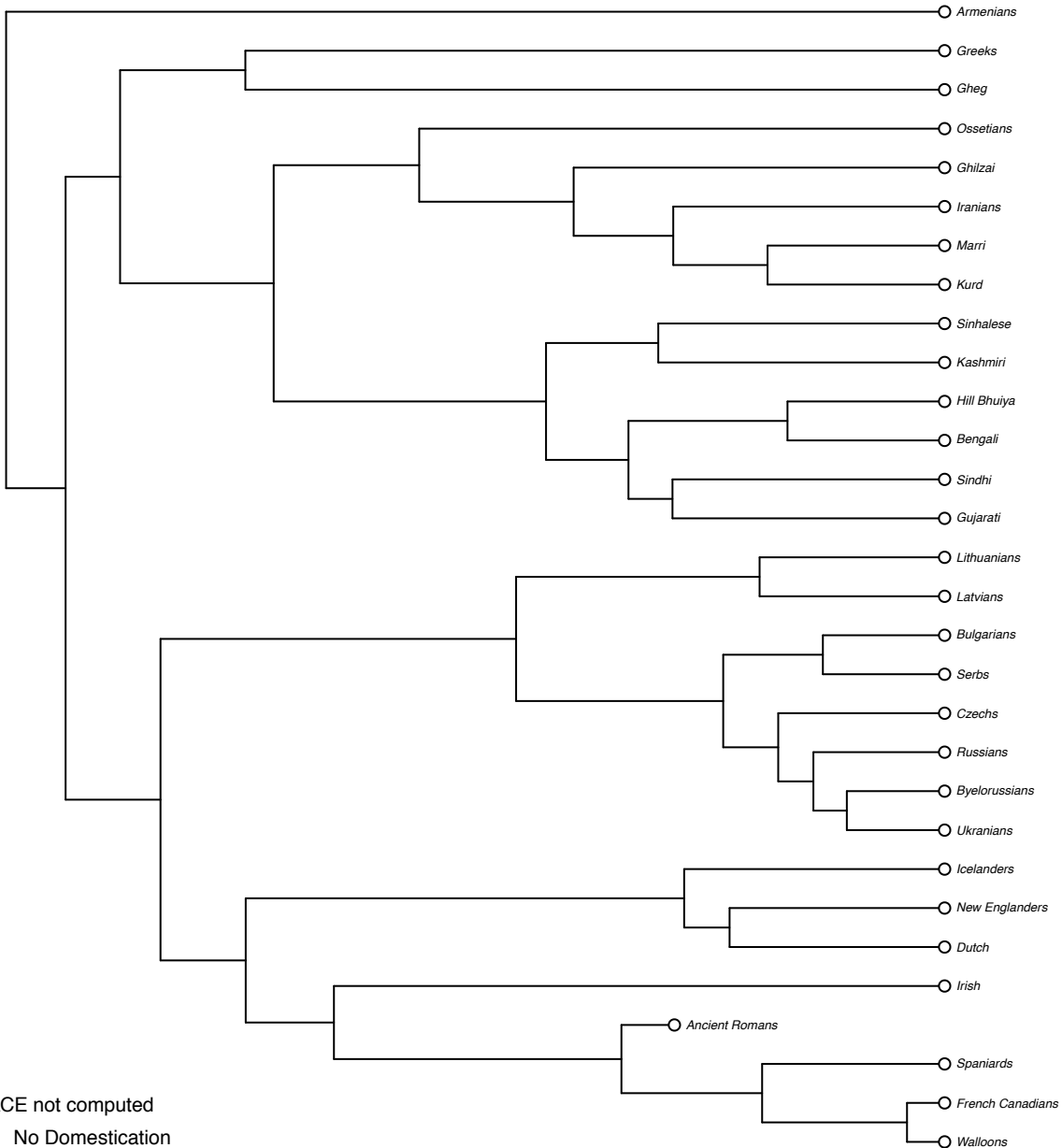

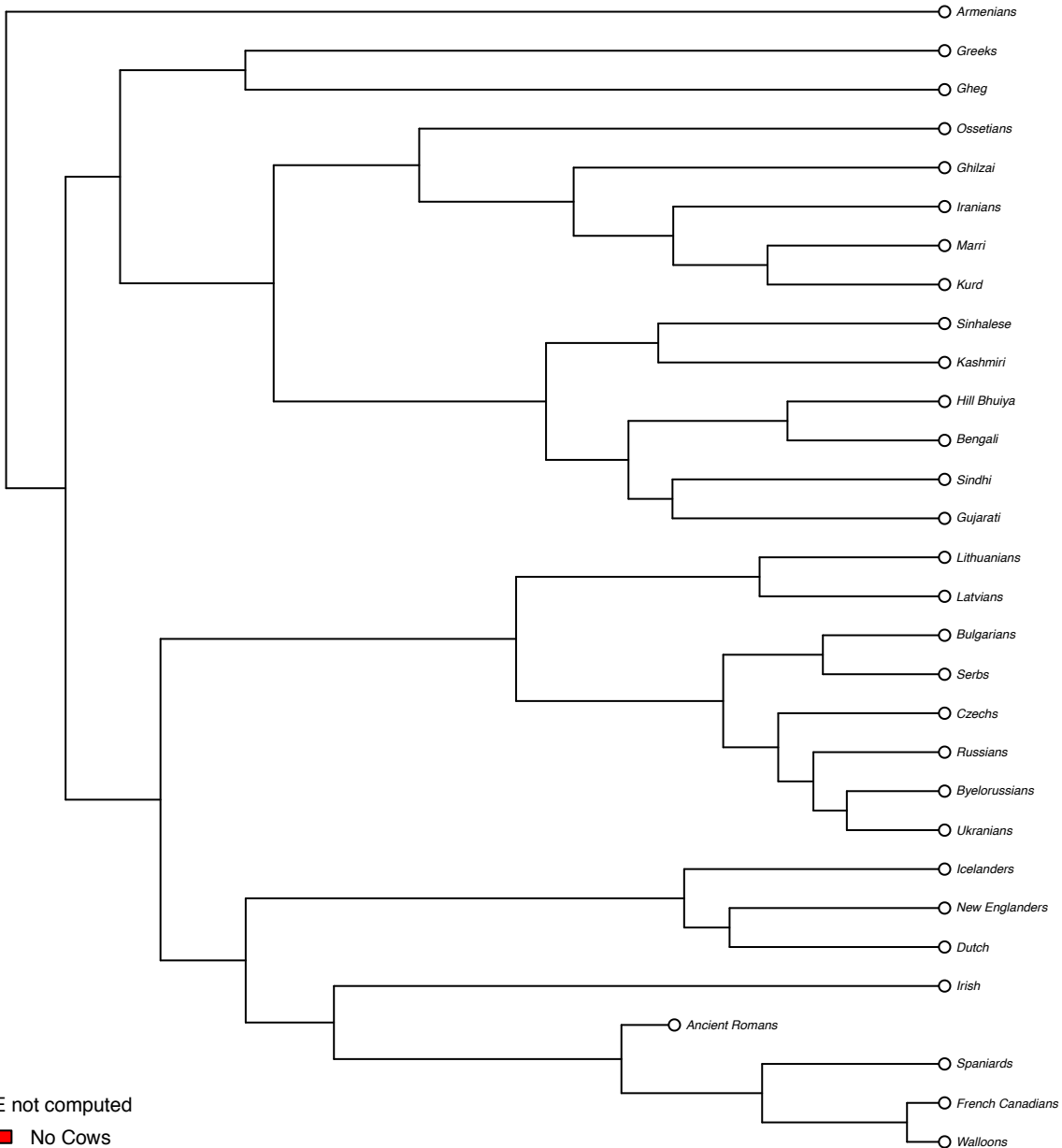

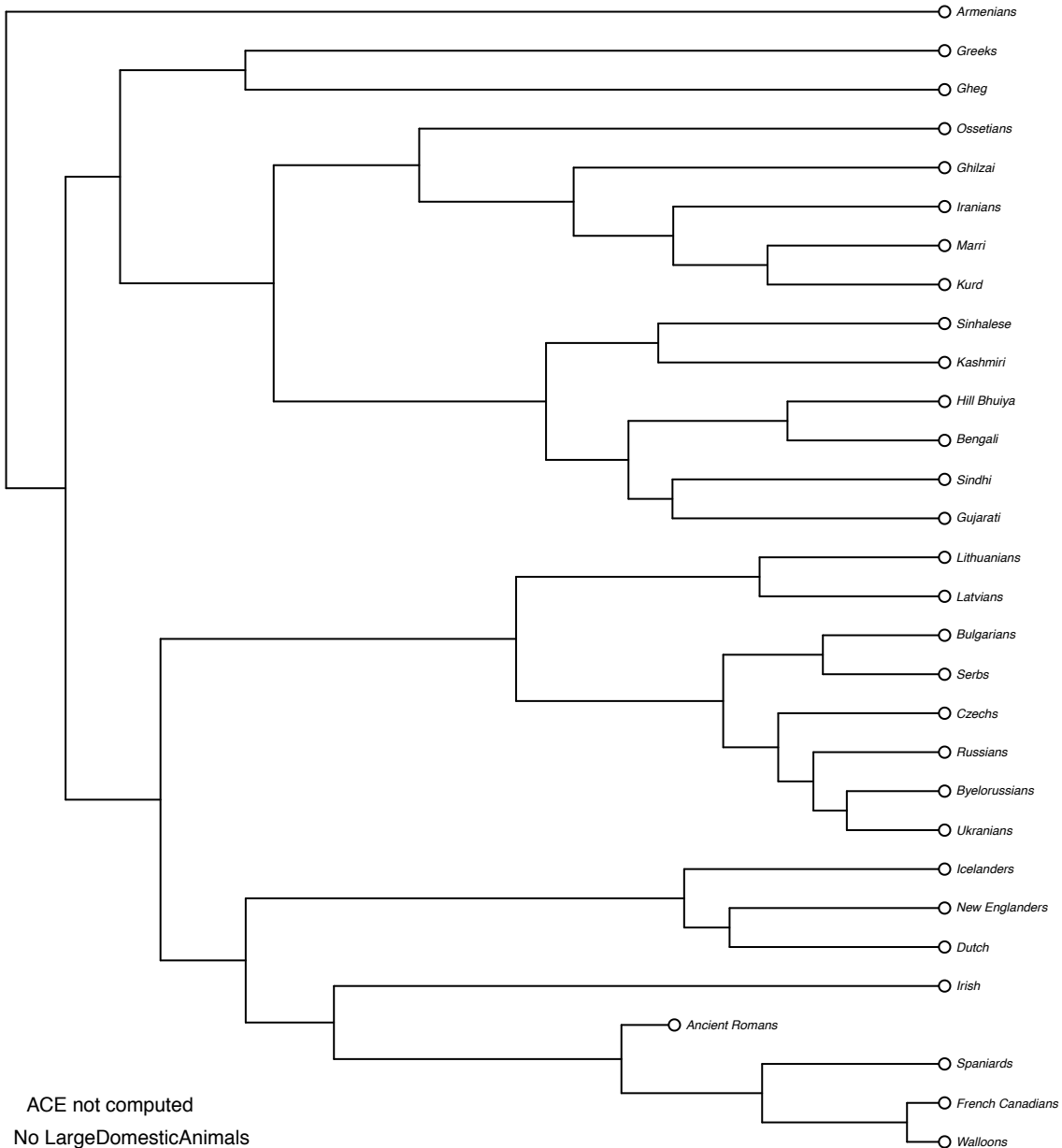

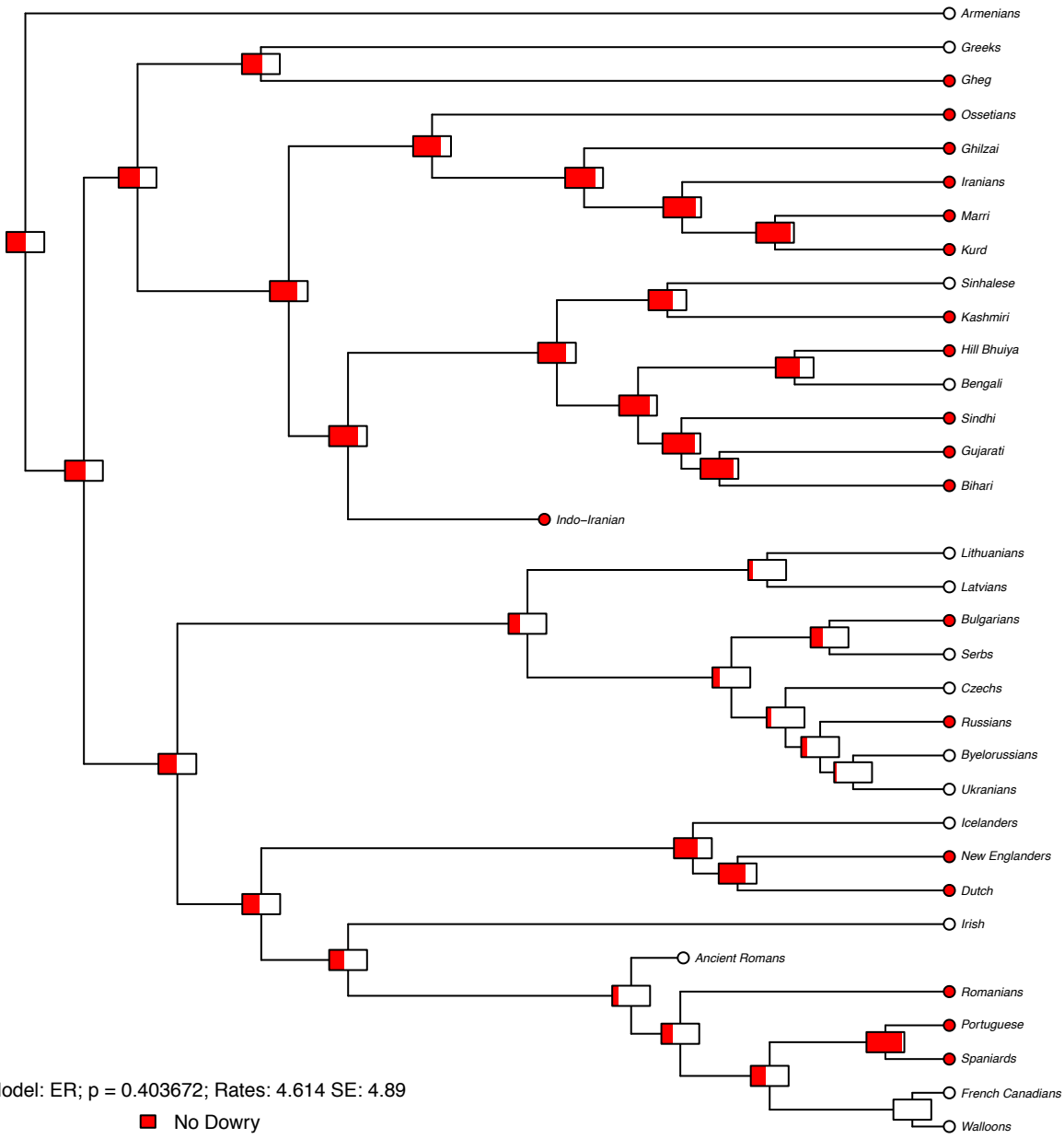

- Armenians
- Greeks
- Gheg
- Ossetians
- Ghilzai
- Iranians
- Marri
- Kurd
- Sinhalese
- Kashmiri
- Hill Bhuiya
- Bengali
- Sindhi
- Gujarati
- Bihari
- Indo-Iranian
- Lithuanians
- Latvians
- Bulgarians
- Serbs
- Czechs
- Russians
- Byelorussians
- Ukrainians
- Icelanders
- New Englanders
- Dutch
- Irish
- Ancient Romans
- Romanians
- Portuguese
- Spaniards
- French Canadians
- Walloons

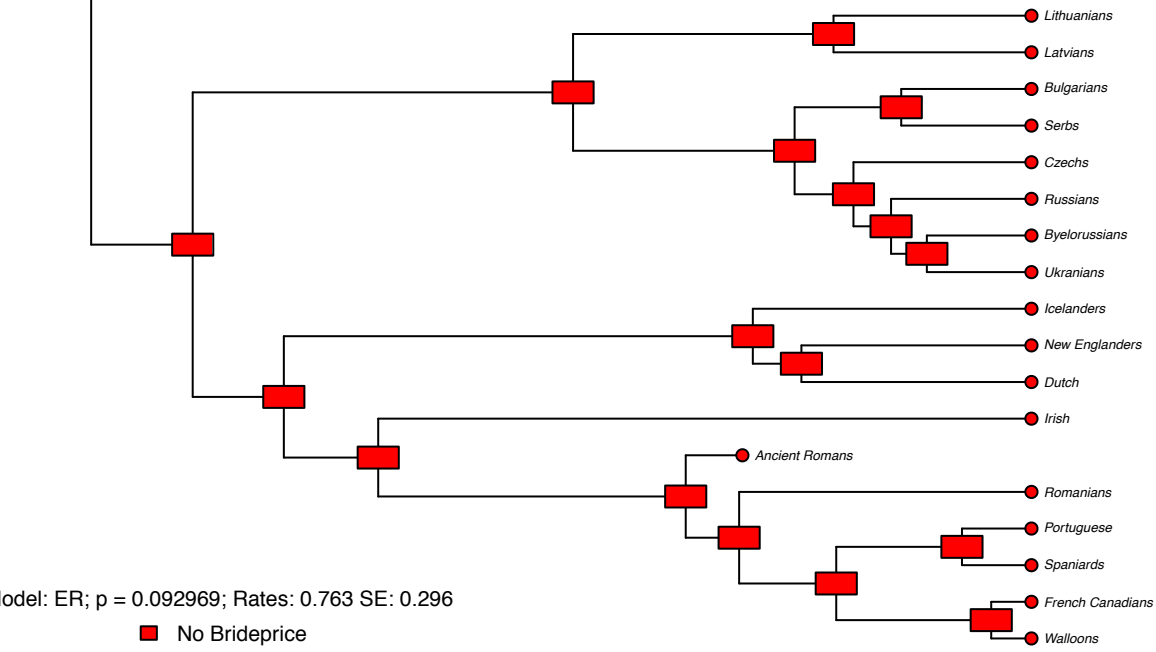
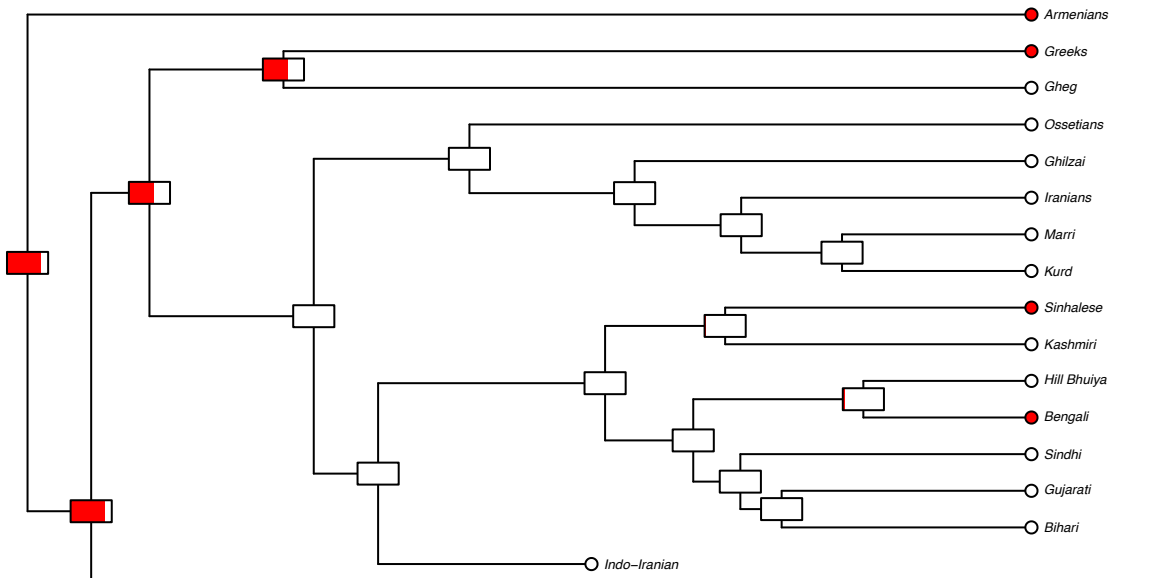

Model: ER; $p = 0.092969$; Rates: 0.763 SE: 0.296

No Brideprice
 Brideprice

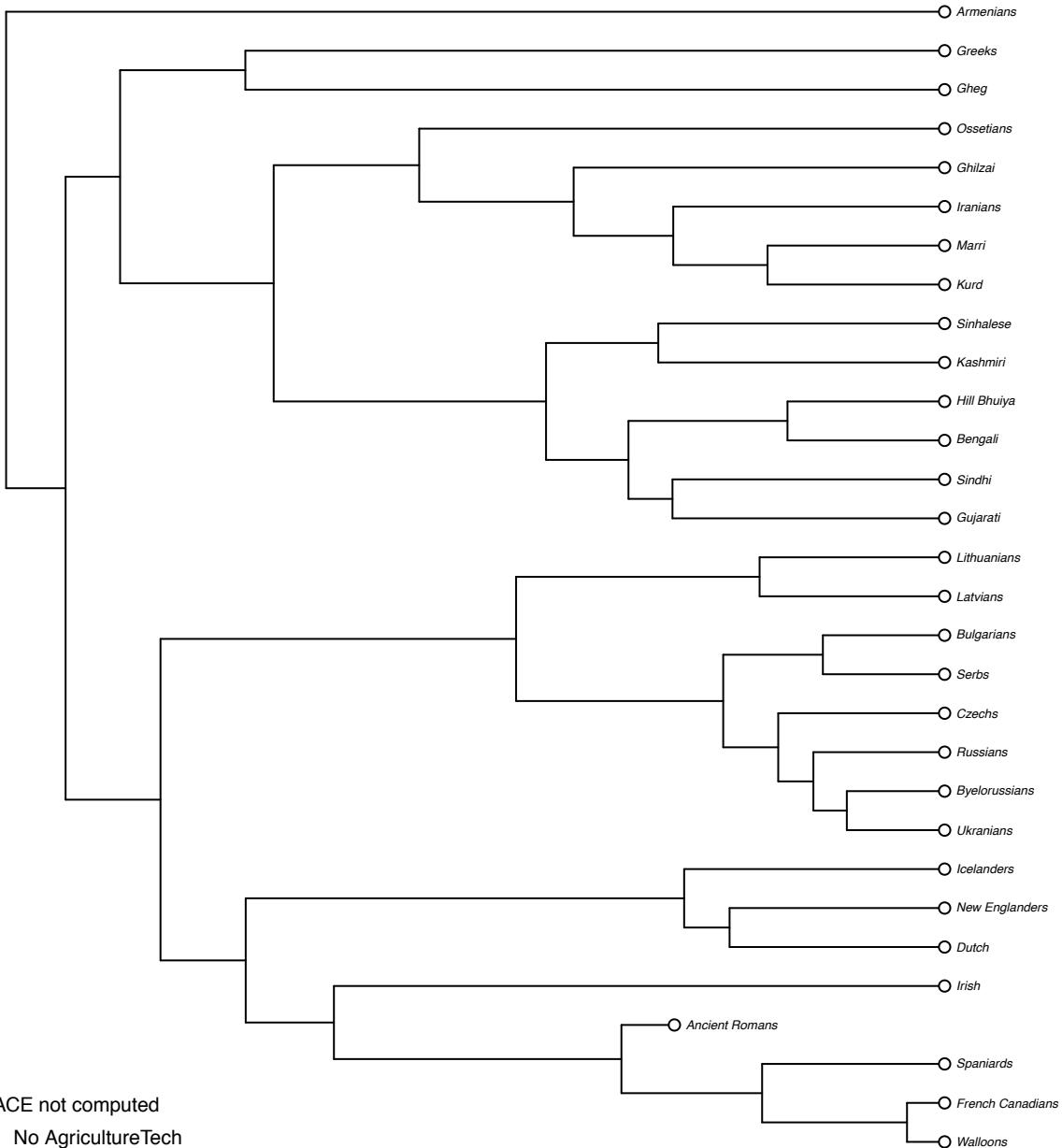

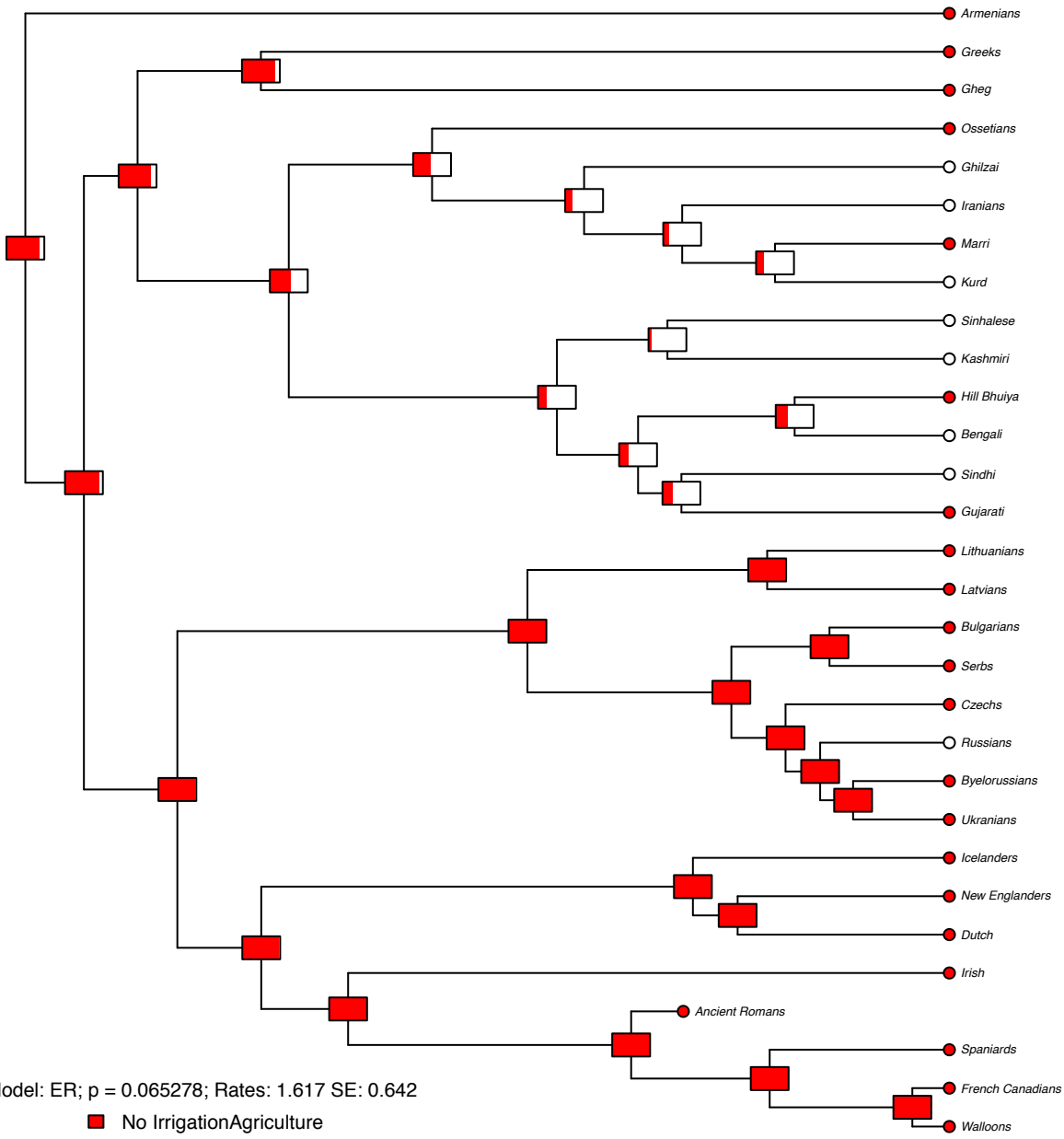

Model: ER; $p = 0.065278$; Rates: 1.617 SE: 0.642

- No IrrigationAgriculture
- IrrigationAgriculture

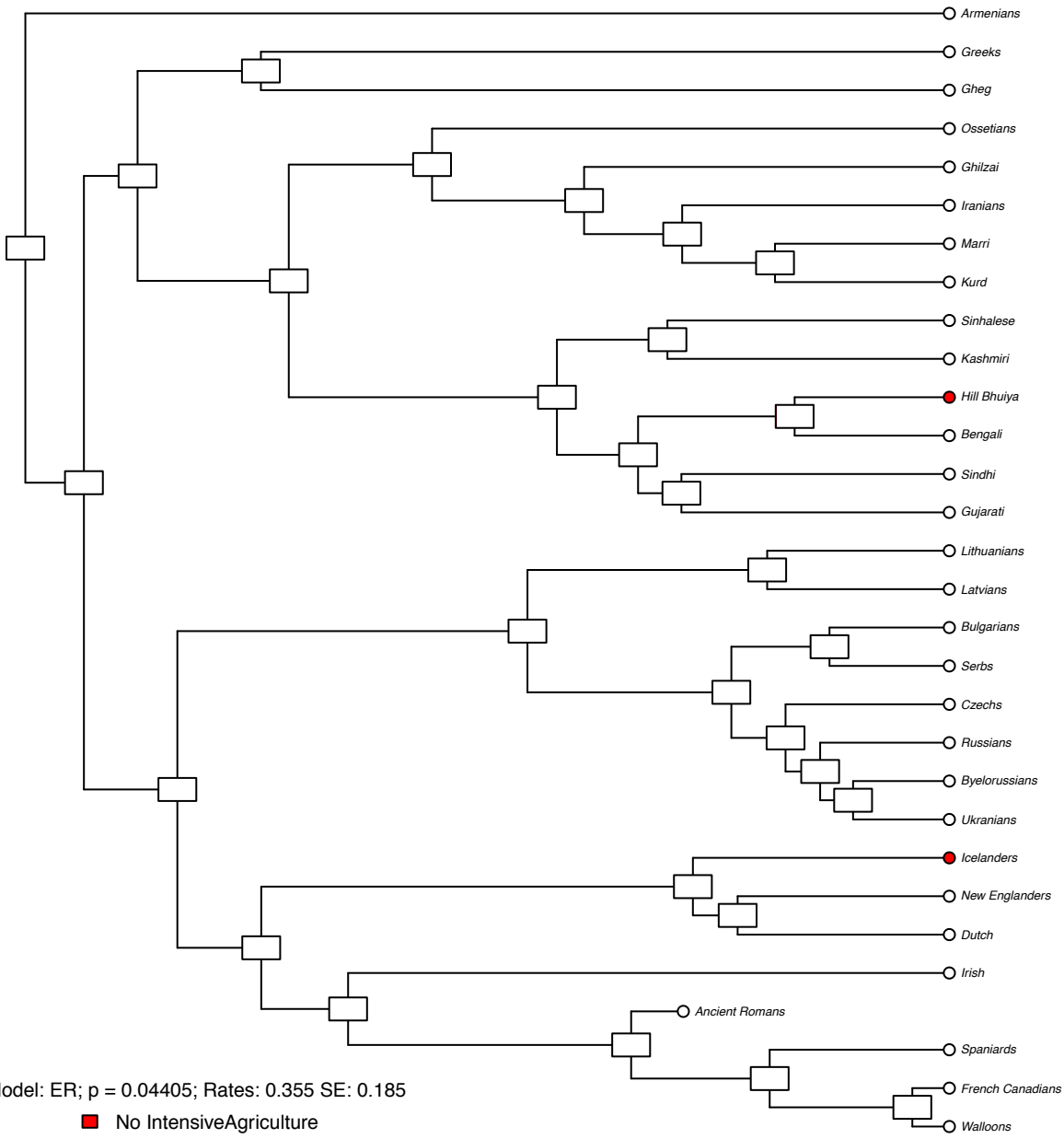

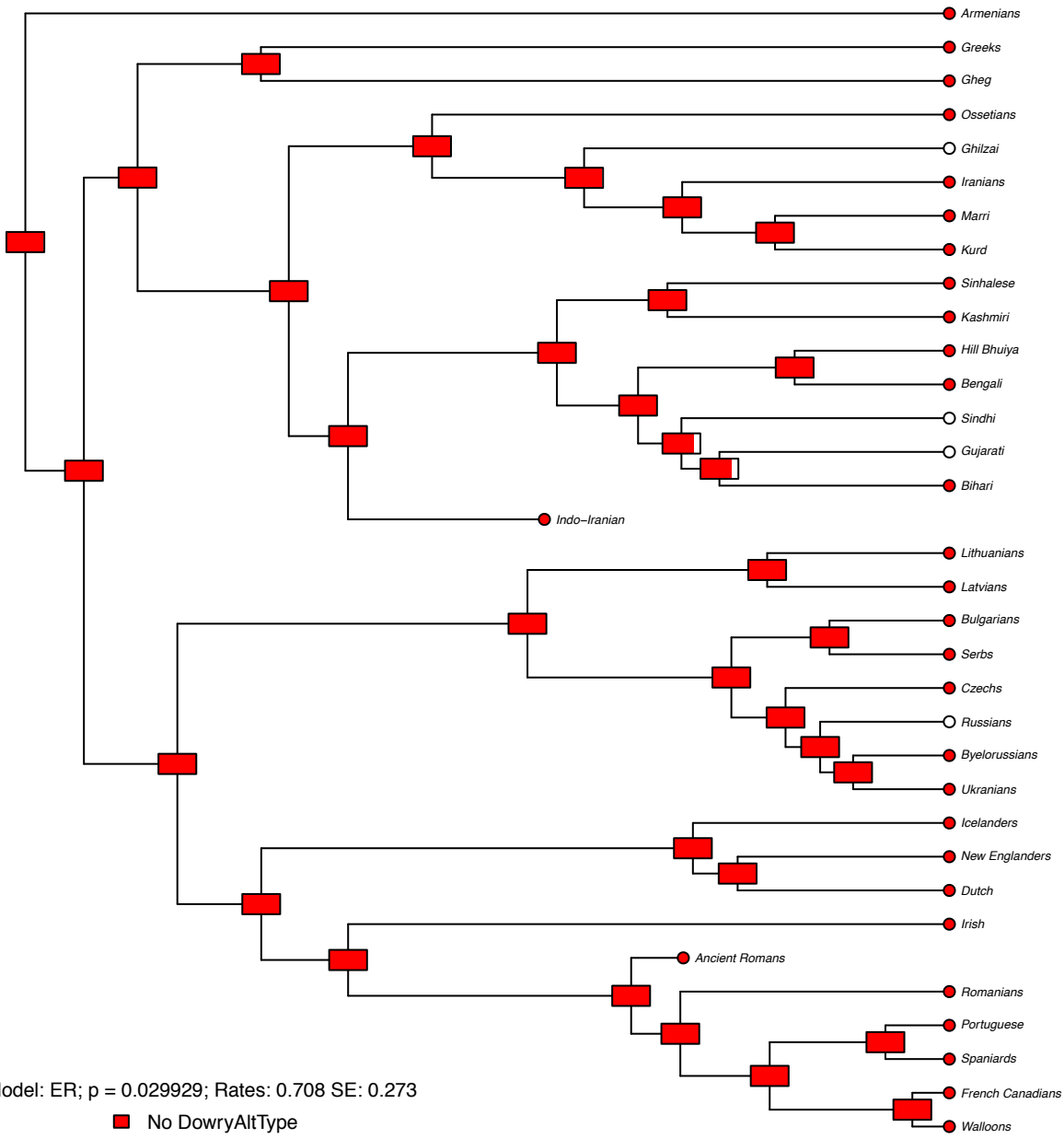

Model: ER; $p = 0.029929$; Rates: 0.708 SE: 0.273

■ No DowryAltType
 DowryAltType

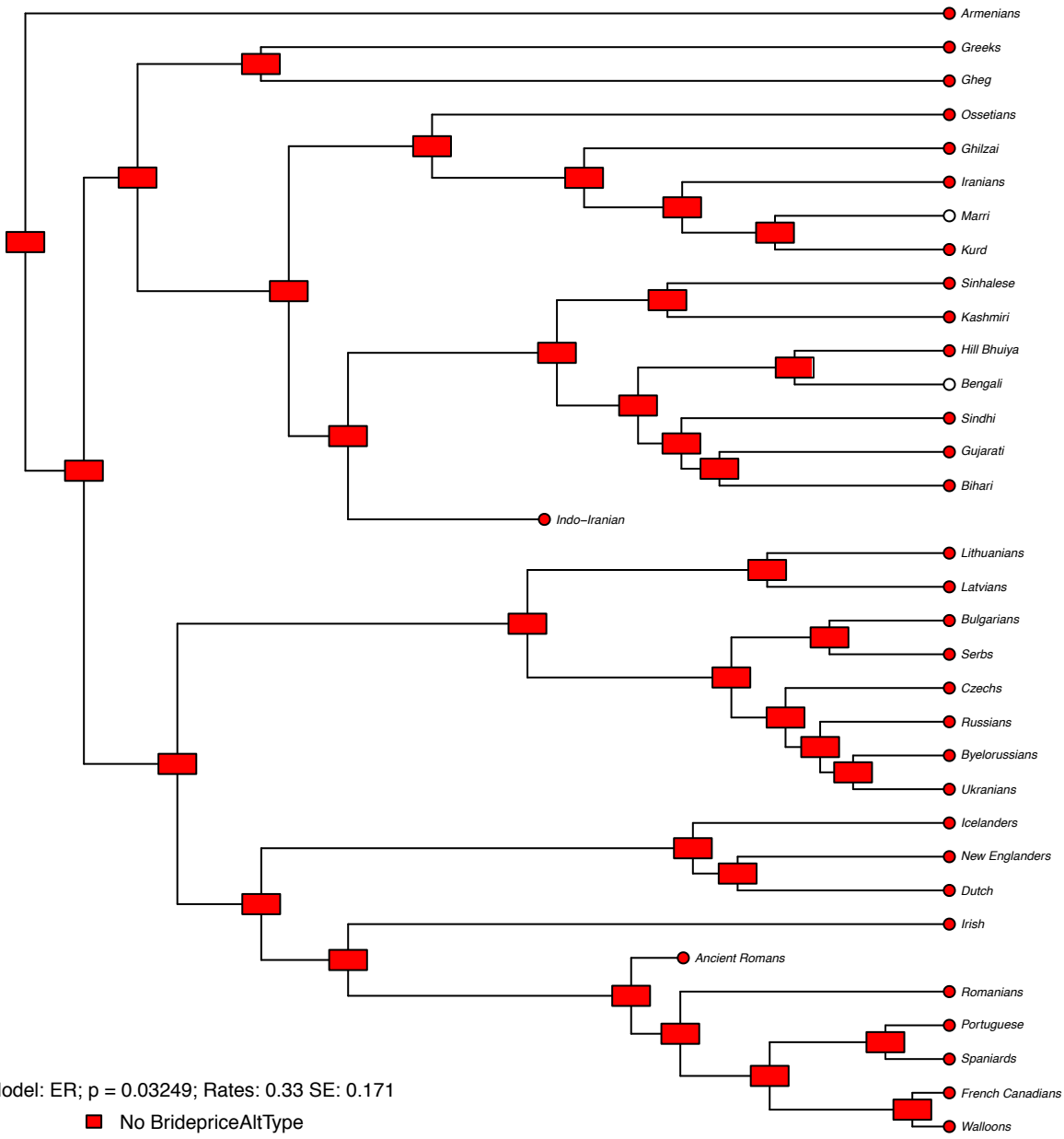

Model: ER; $p = 0.03249$; Rates: 0.33 SE: 0.171

- No BridepriceAltType
- BridepriceAltType

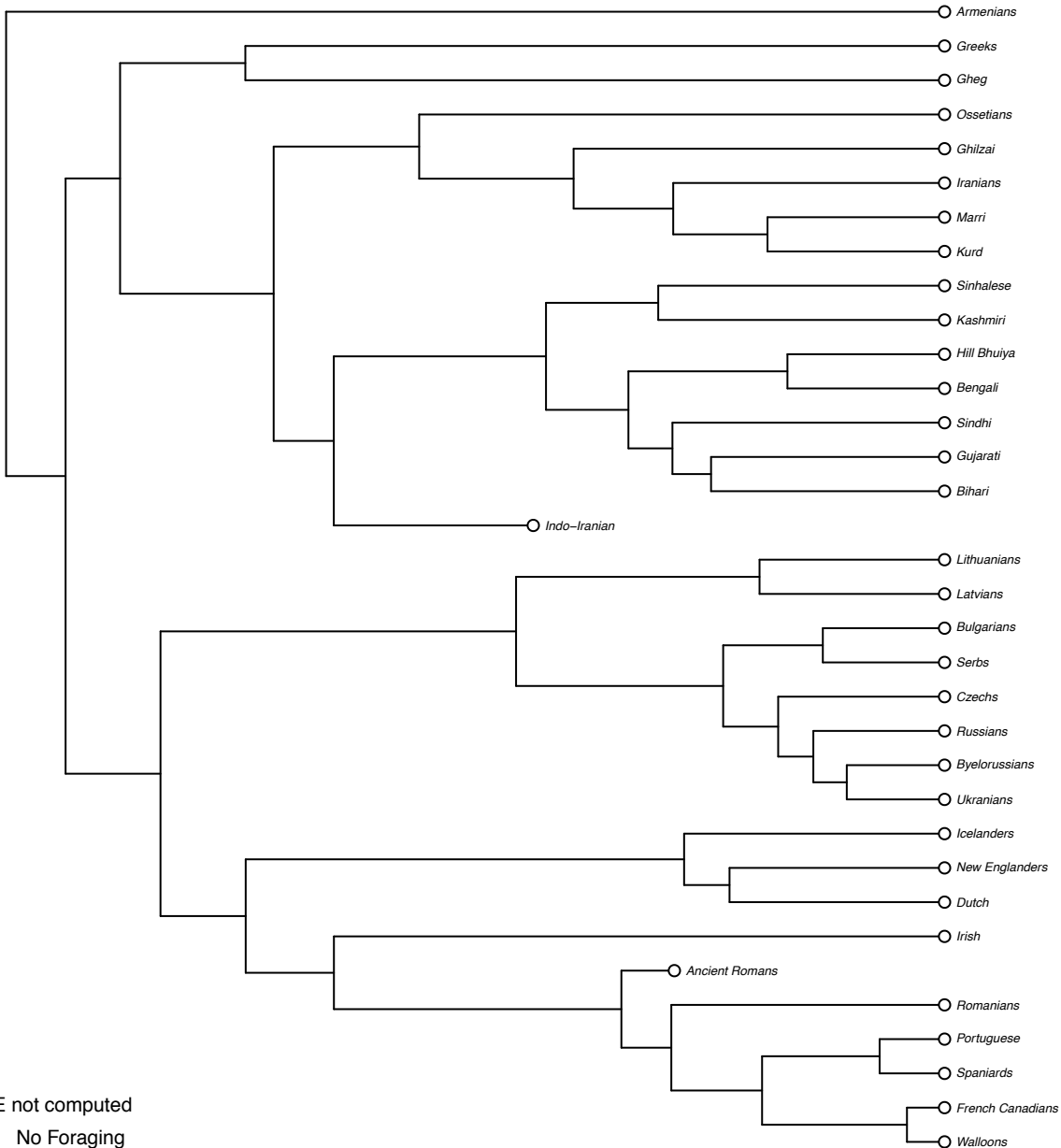

ACE not computed

- No Foraging
- Foraging

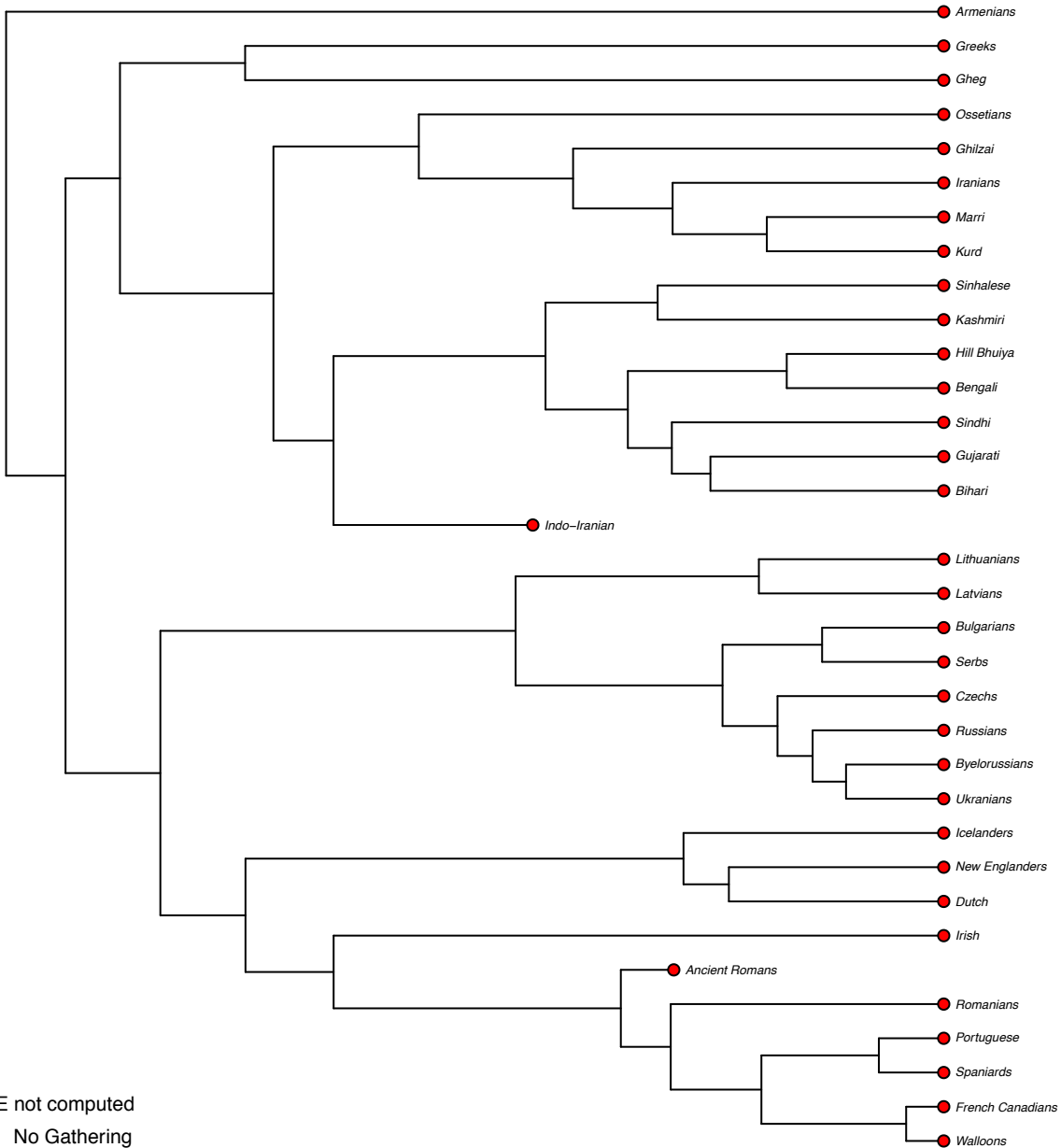

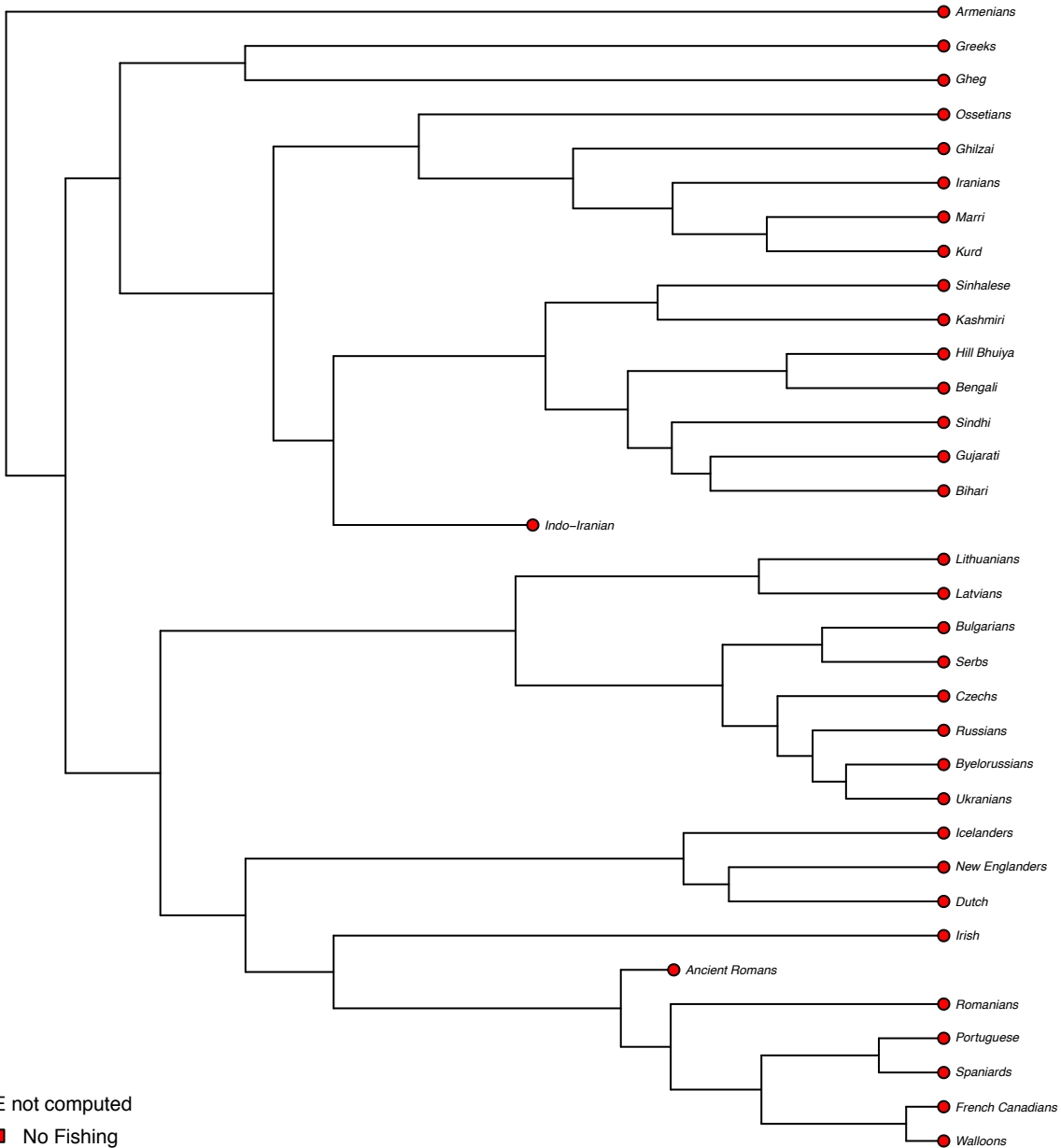

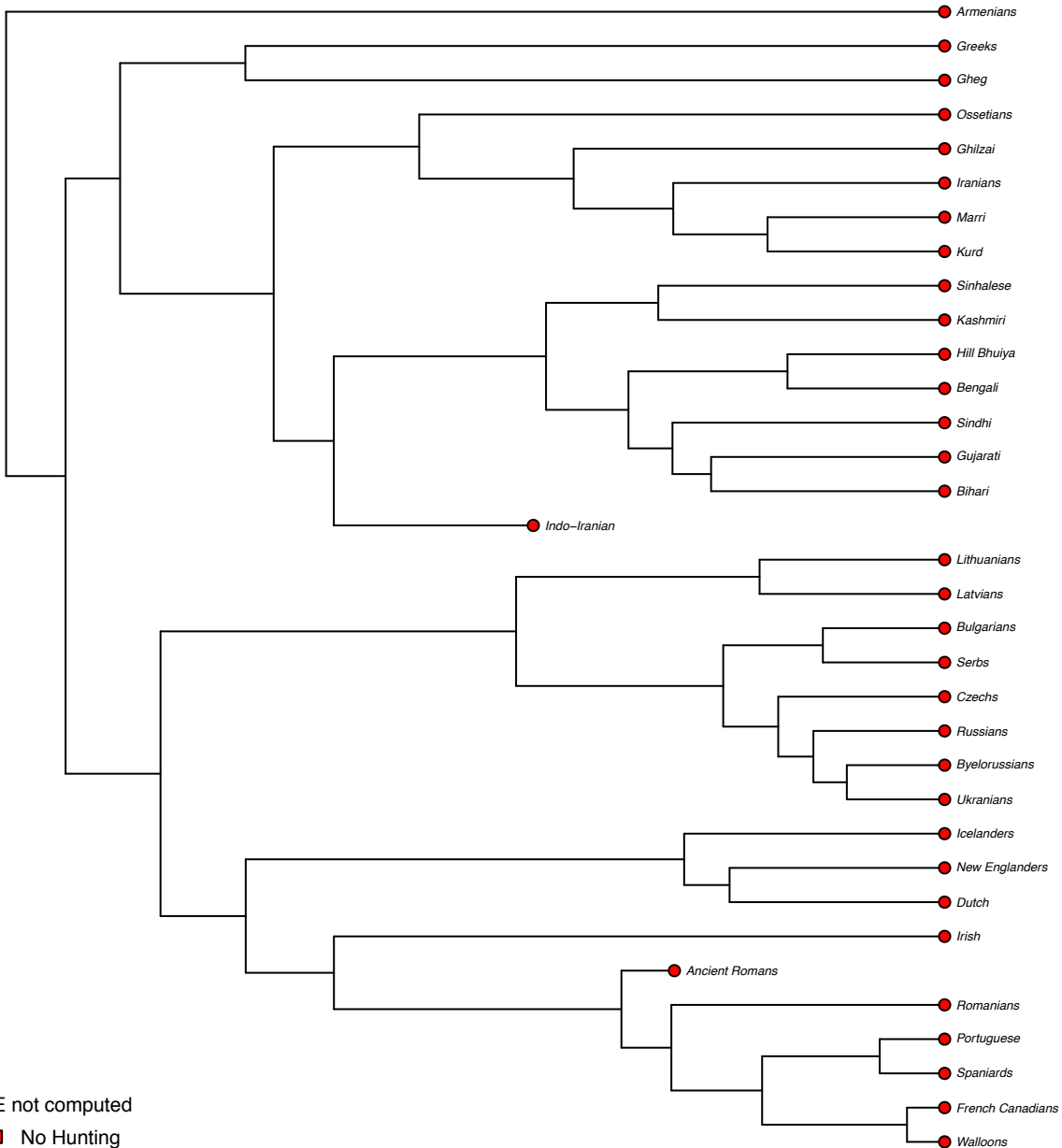

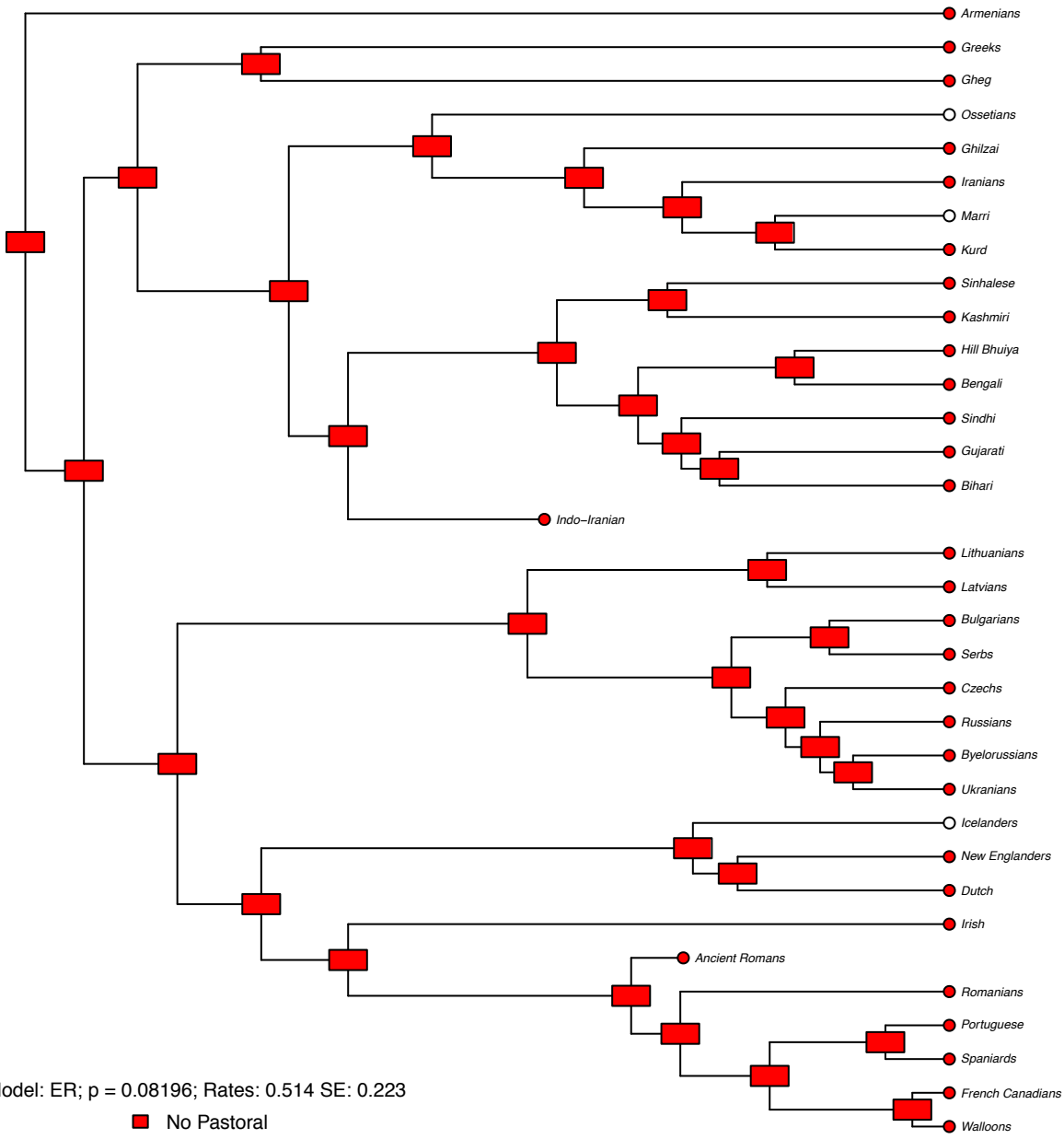

Model: ER; $p = 0.08196$; Rates: 0.514 SE: 0.223

- No Pastoral
- Pastoral

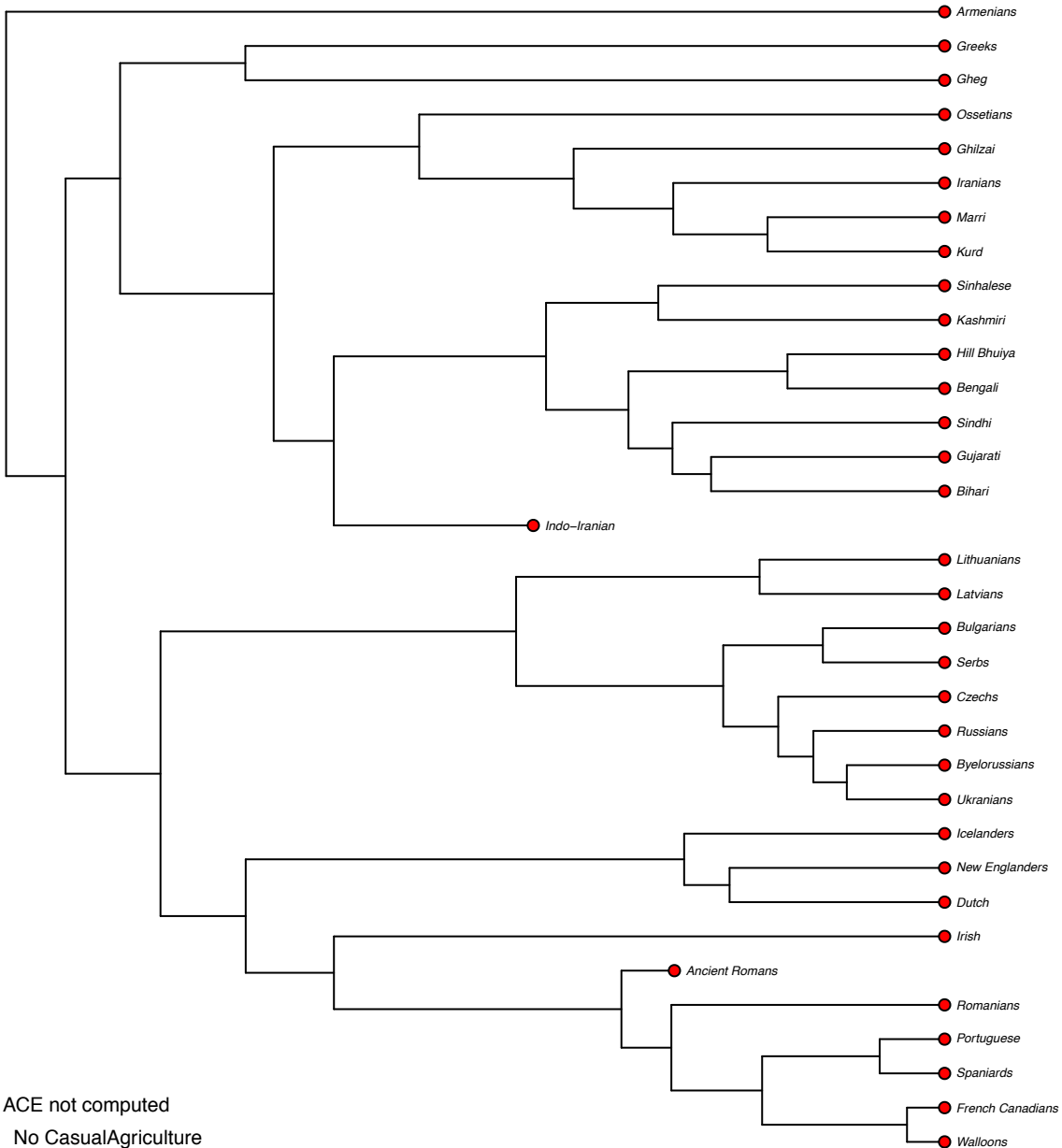

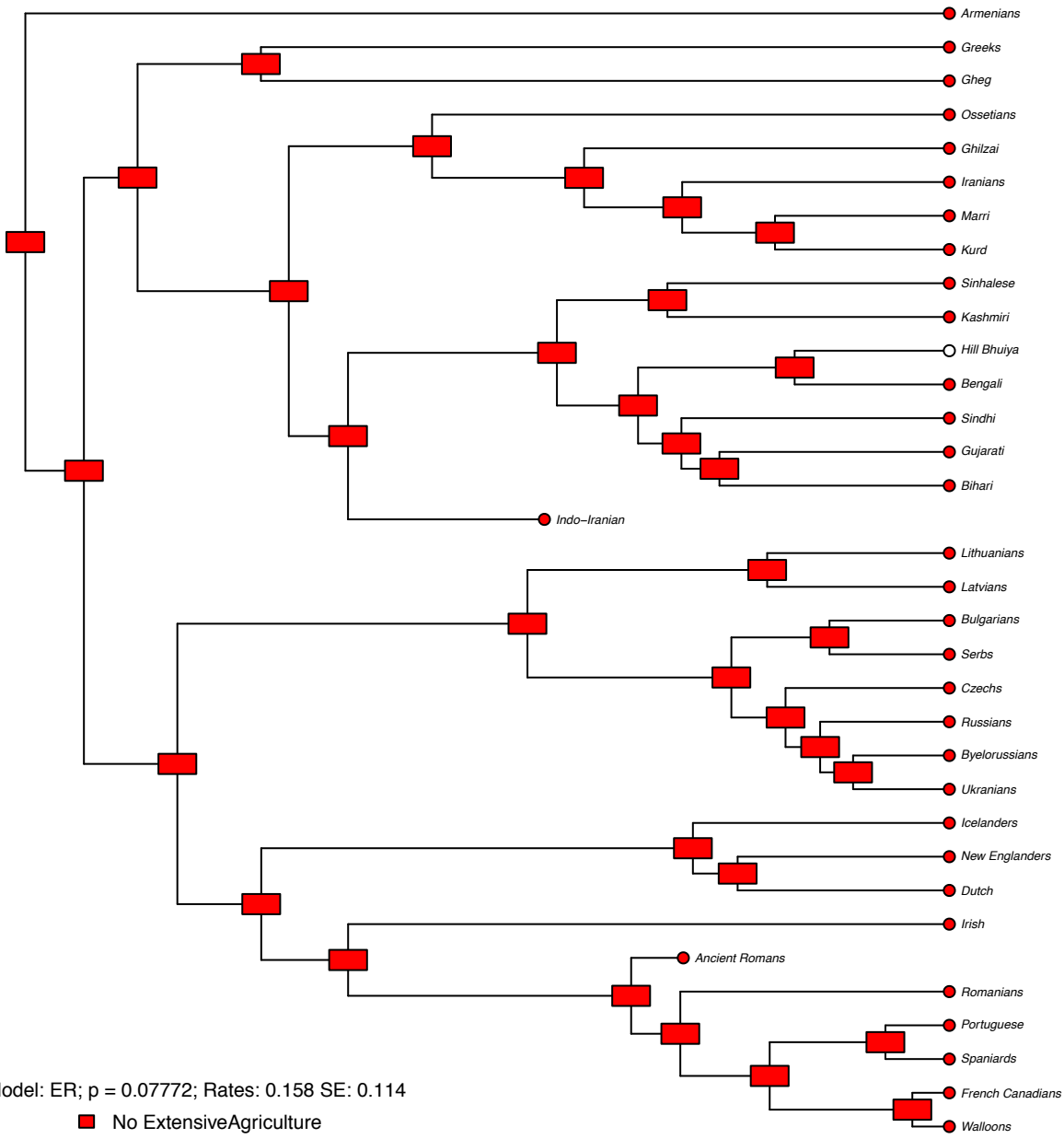

Model: ER; $p = 0.07772$; Rates: 0.158 SE: 0.114

- No ExtensiveAgriculture
- ExtensiveAgriculture

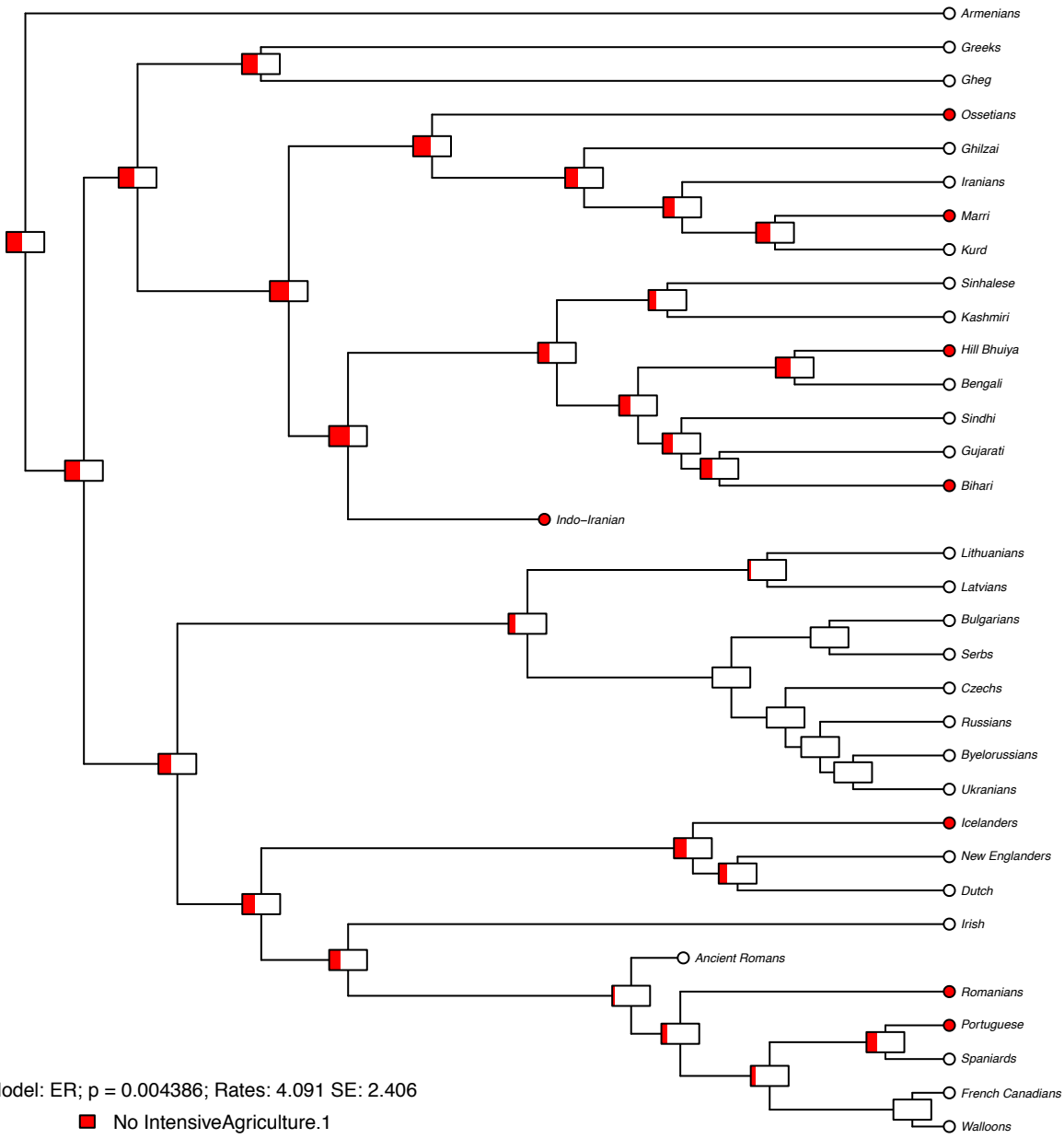

Model: ER; $p = 0.004386$; Rates: 4.091 SE: 2.406

- No IntensiveAgriculture.1
- IntensiveAgriculture.1

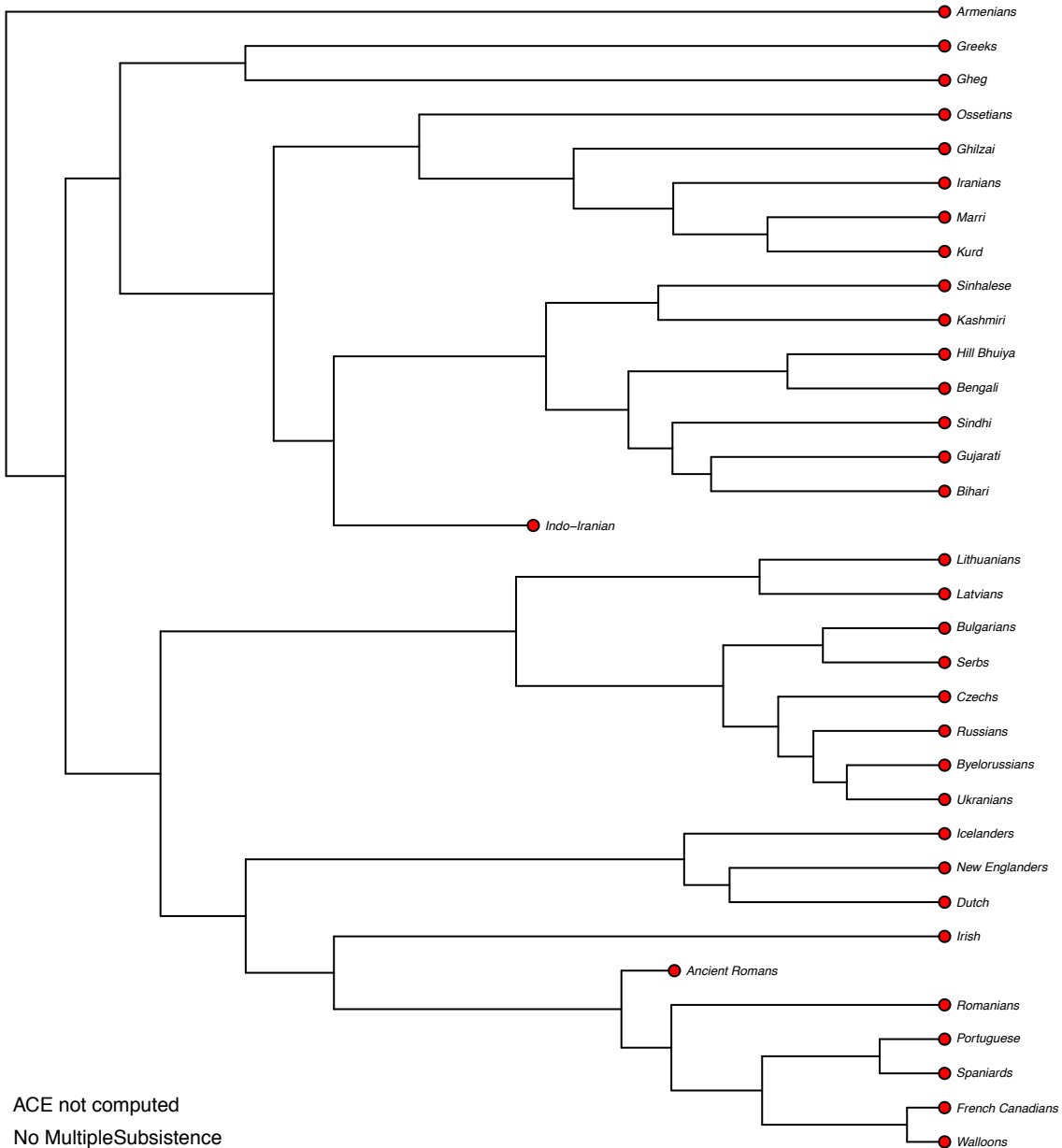

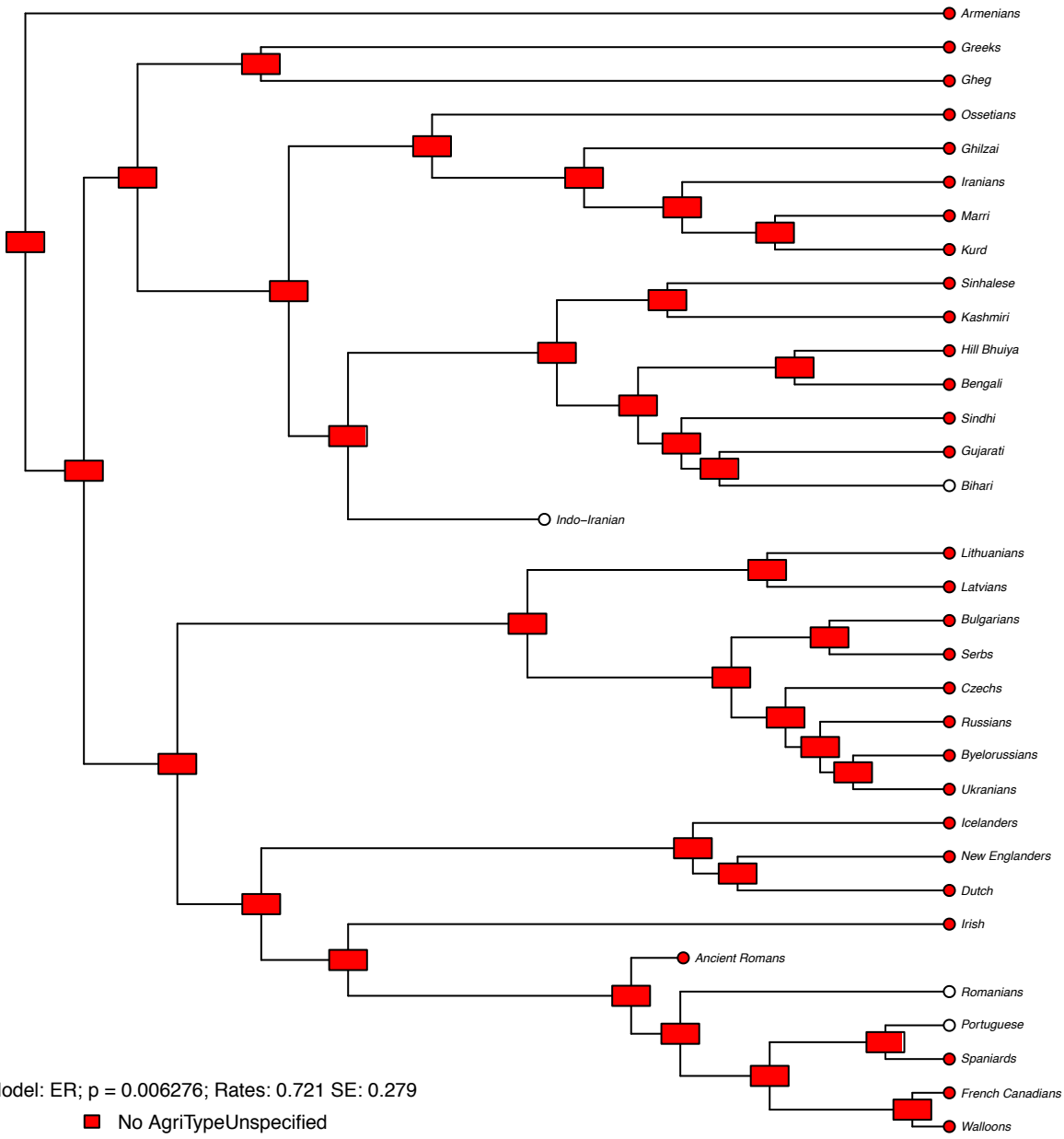

Model: ER; $p = 0.006276$; Rates: 0.721 SE: 0.279

- No AgriTypeUnspecified
- AgriTypeUnspecified

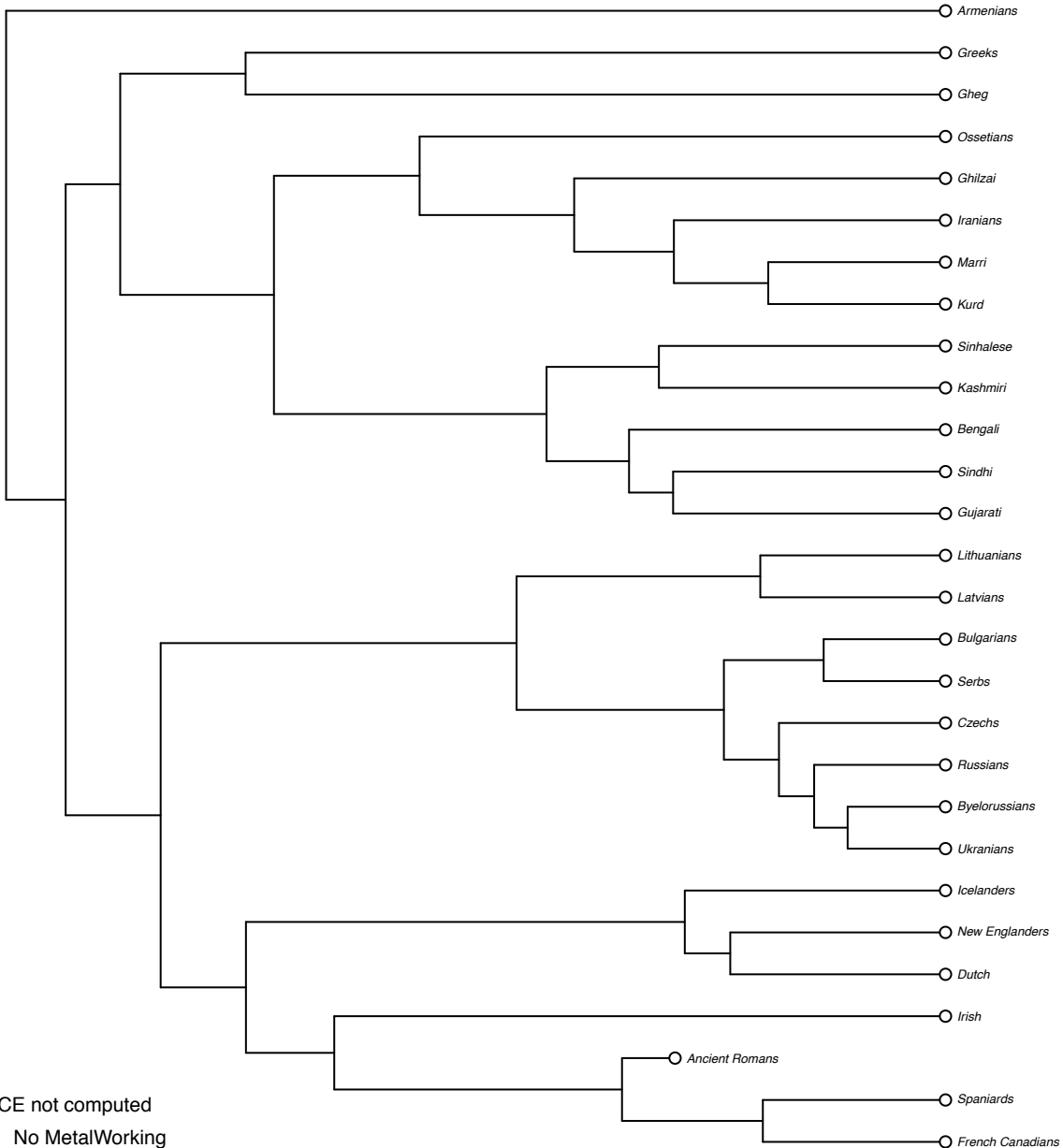

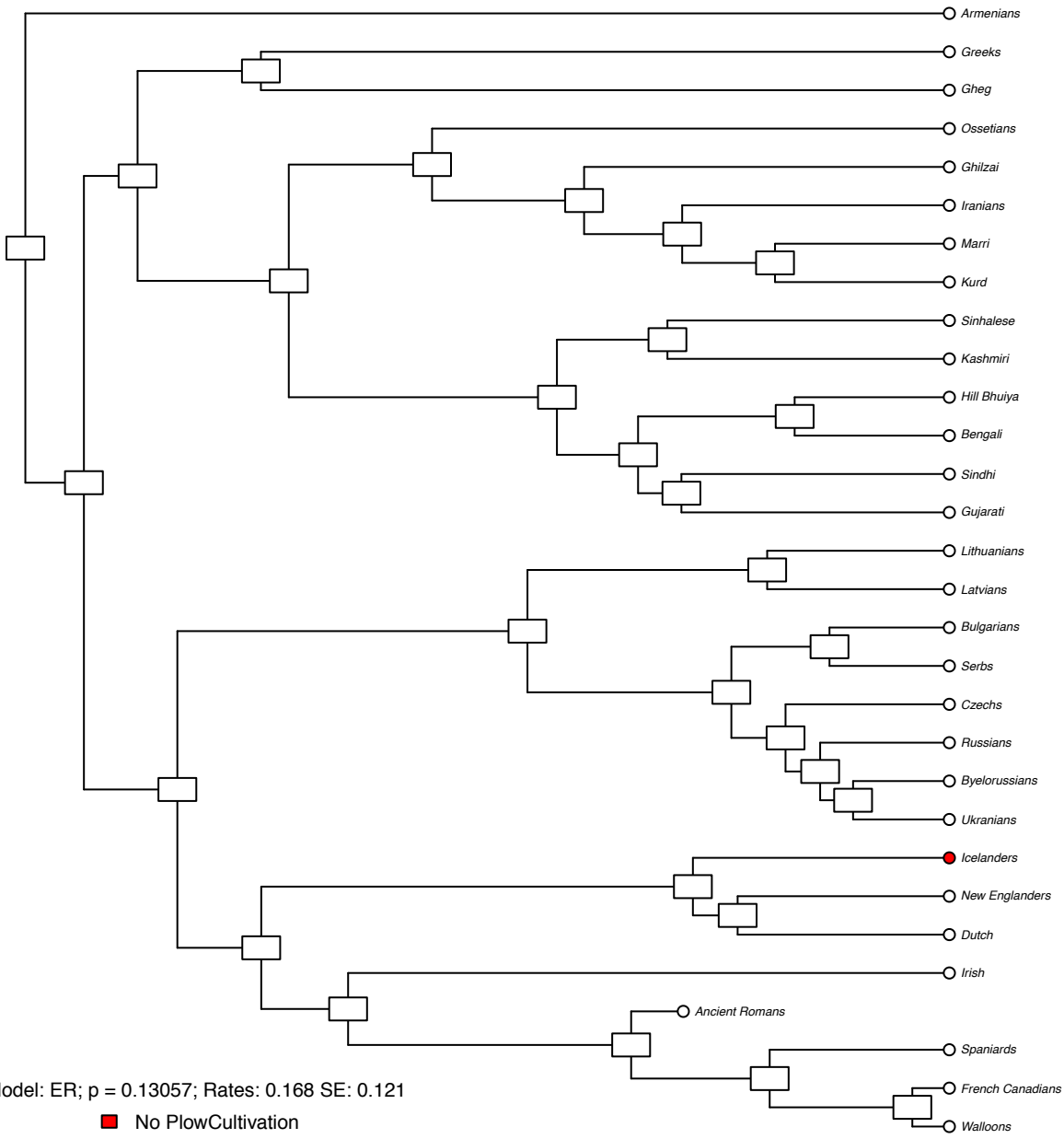

Armenians
 Greeks
 Ghag
 Ossetians
 Ghilzai
 Iranians
 Marri
 Kurd
 Sinhalese
 Kashmiri
 Hill Bhuiya
 Bengali
 Sindhi
 Gujarati
 Lithuanians
 Latvians
 Bulgarians
 Serbs
 Czechs
 Russians
 Byelorussians
 Ukrainians
 Icelanders
 New Englanders
 Dutch
 Irish
 Ancient Romans
 Spaniards
 French Canadians
 Wallons

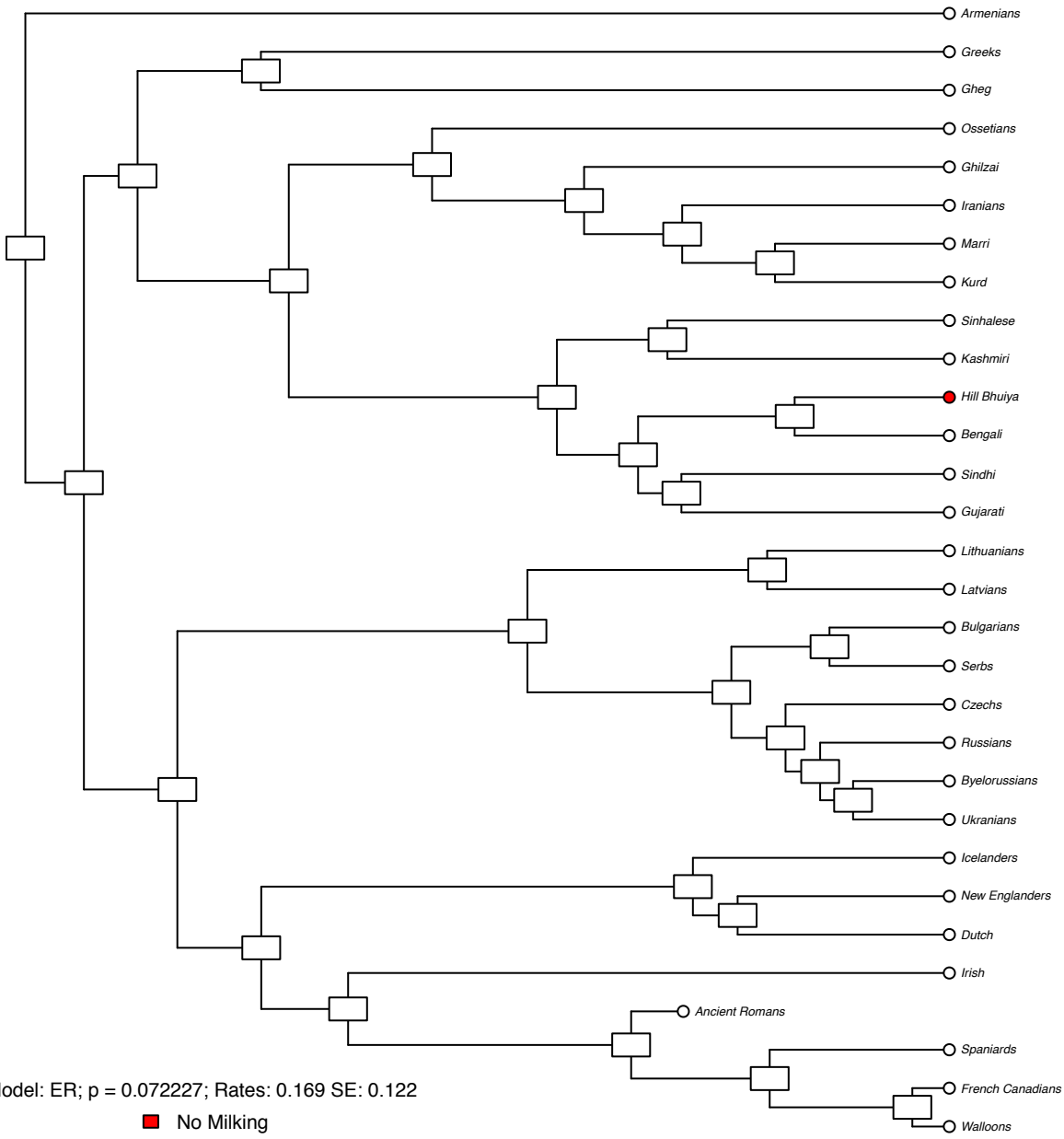

Model: ER; $p = 0.072227$; Rates: 0.169 SE: 0.122

■ No Milking
 Milking

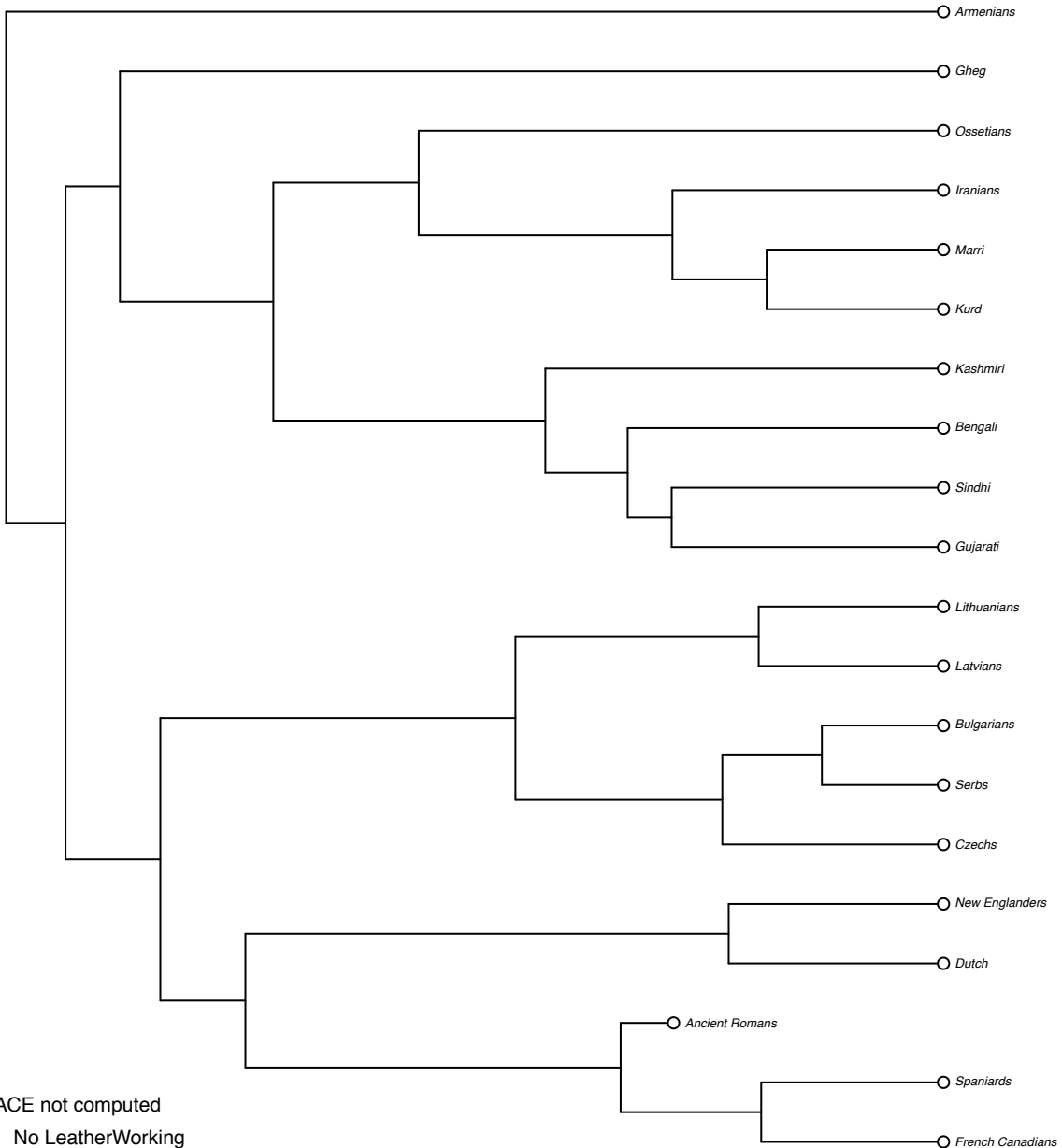

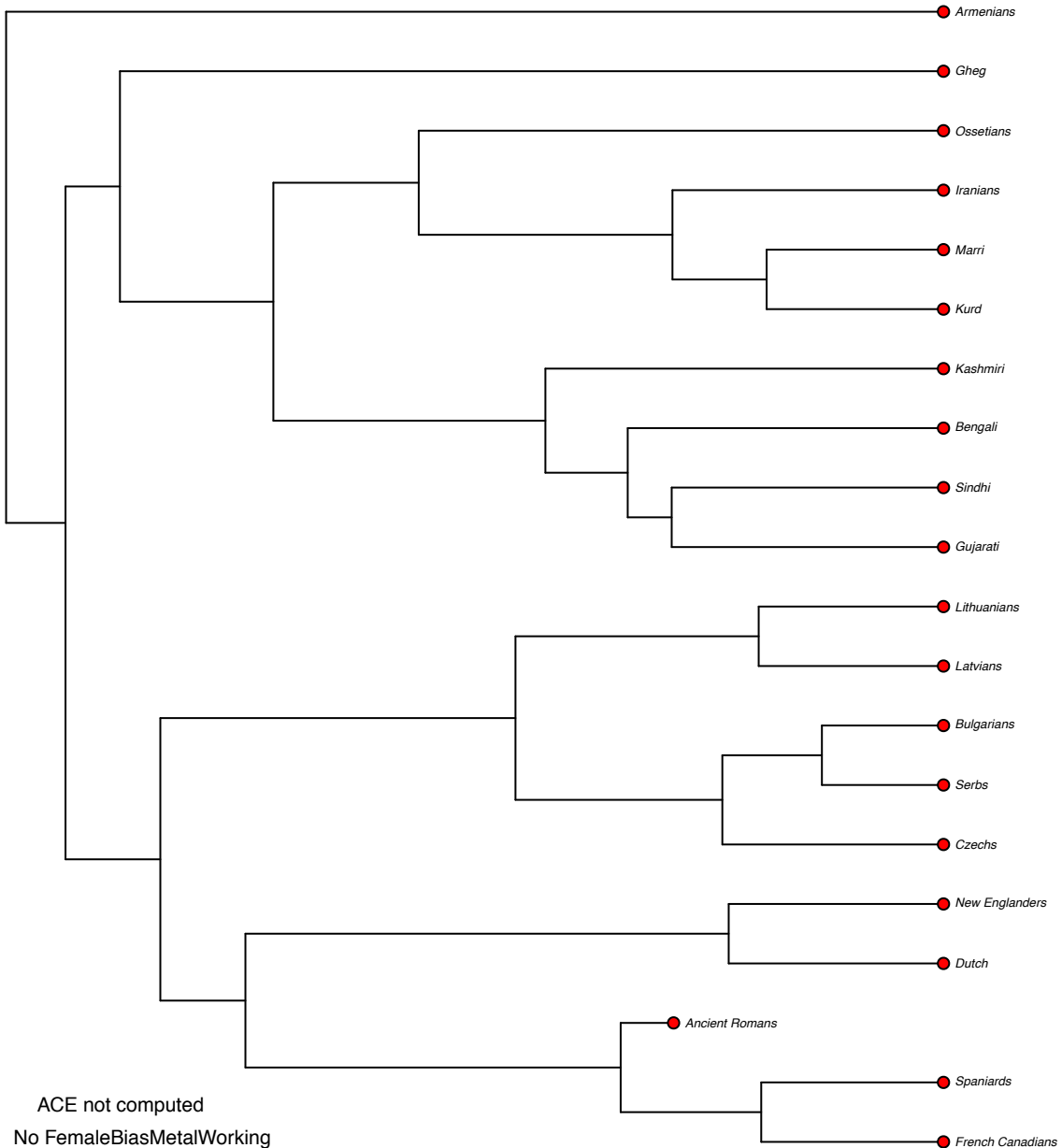

● Armenians

● Gheg

● Ossetians

● Iranians

● Marri

● Kurd

● Kashmiri

● Bengali

● Sindhi

● Gujarati

● Lithuanians

● Latvians

● Bulgarians

● Serbs

● Czechs

● New Englanders

● Dutch

● Ancient Romans

● Spaniards

● French Canadians

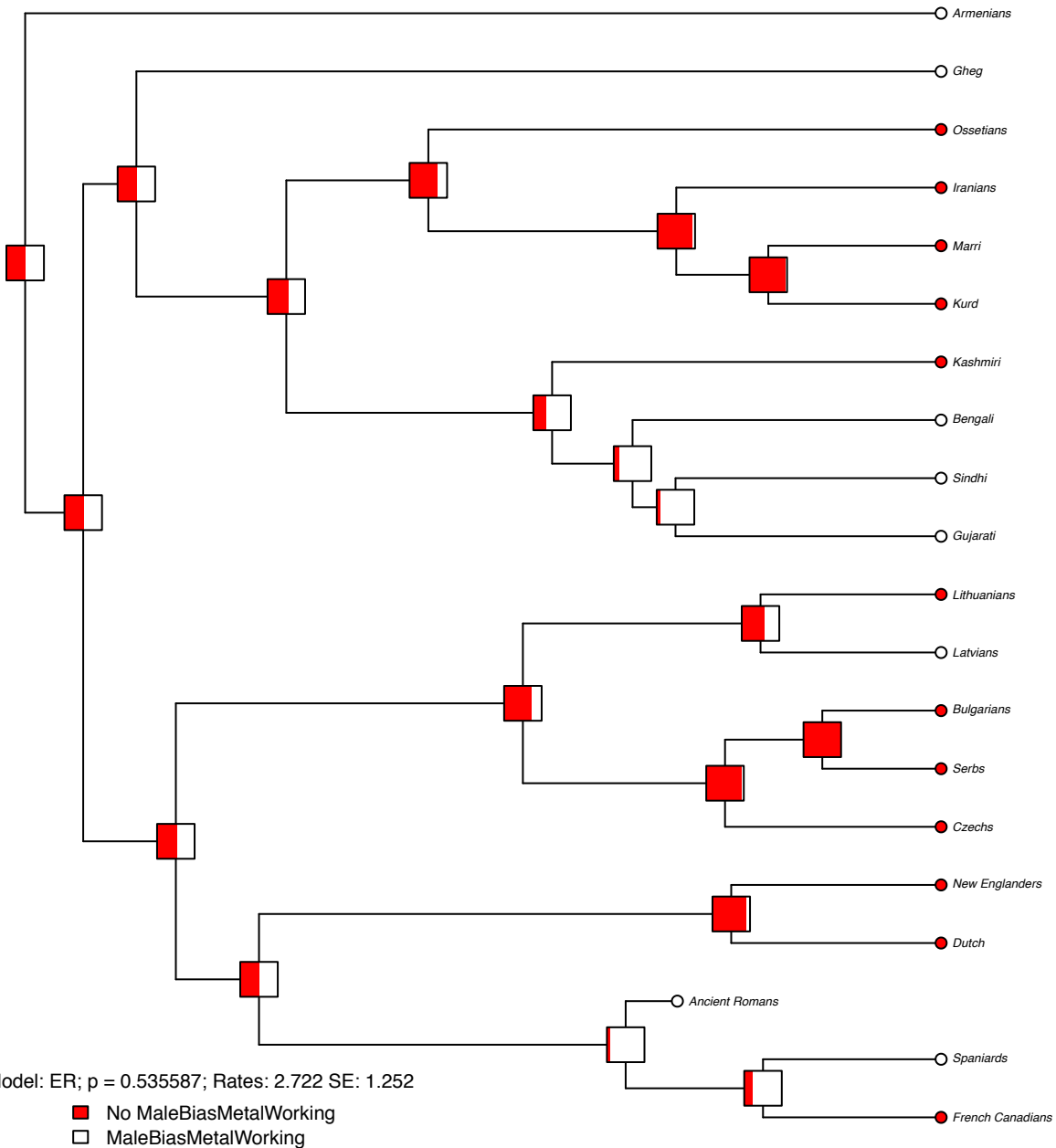

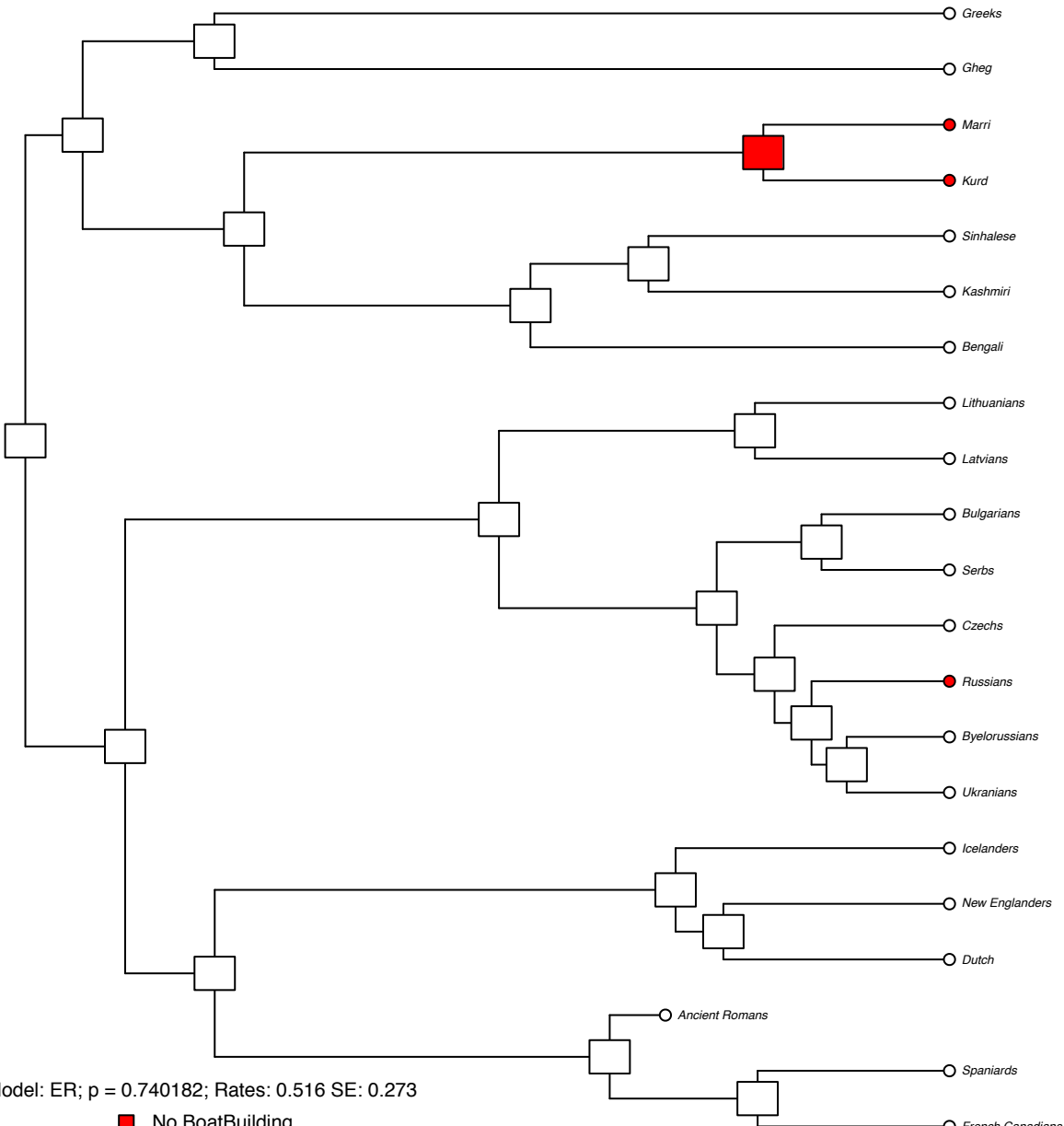

Greeks
 Gheg
 Marri
 Kurd
 Sinhalese
 Kashmiri
 Bengali
 Lithuanians
 Latvians
 Bulgarians
 Serbs
 Czechs
 Russians
 Byelorussians
 Ukrainians
 Icelanders
 New Englanders
 Dutch
 Ancient Romans
 Spaniards
 French Canadians

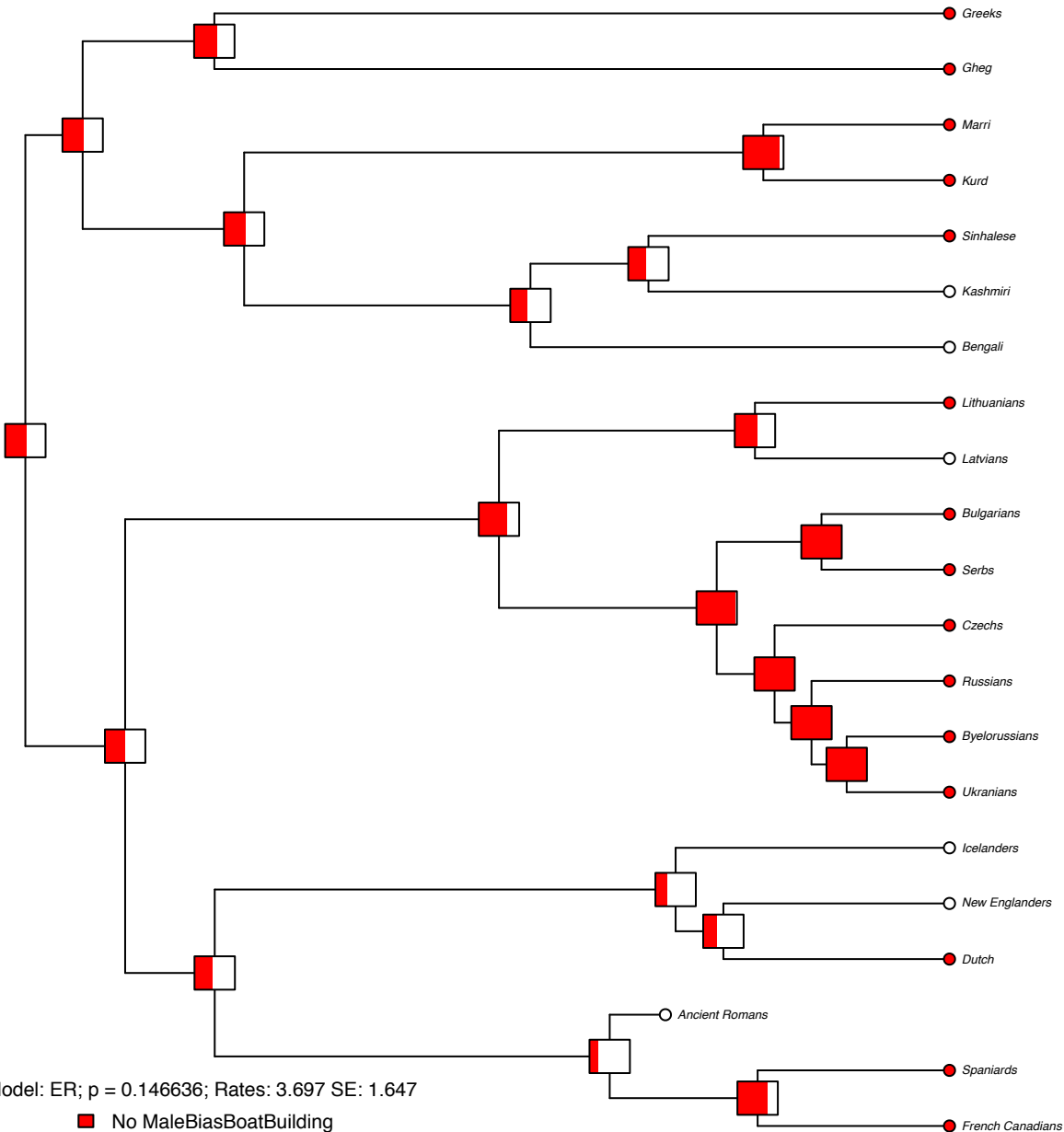

- *Greeks*
- *Gheg*
- *Marri*
- *Kurd*
- *Sinhalese*
- Kashmiri*
- Bengali*
- *Lithuanians*
- Latvians*
- *Bulgarians*
- *Serbs*
- *Czechs*
- *Russians*
- *Byelorussians*
- *Ukrainians*
- Icelanders*
- New Englanders*
- *Dutch*
- Ancient Romans*
- *Spaniards*
- *French Canadians*

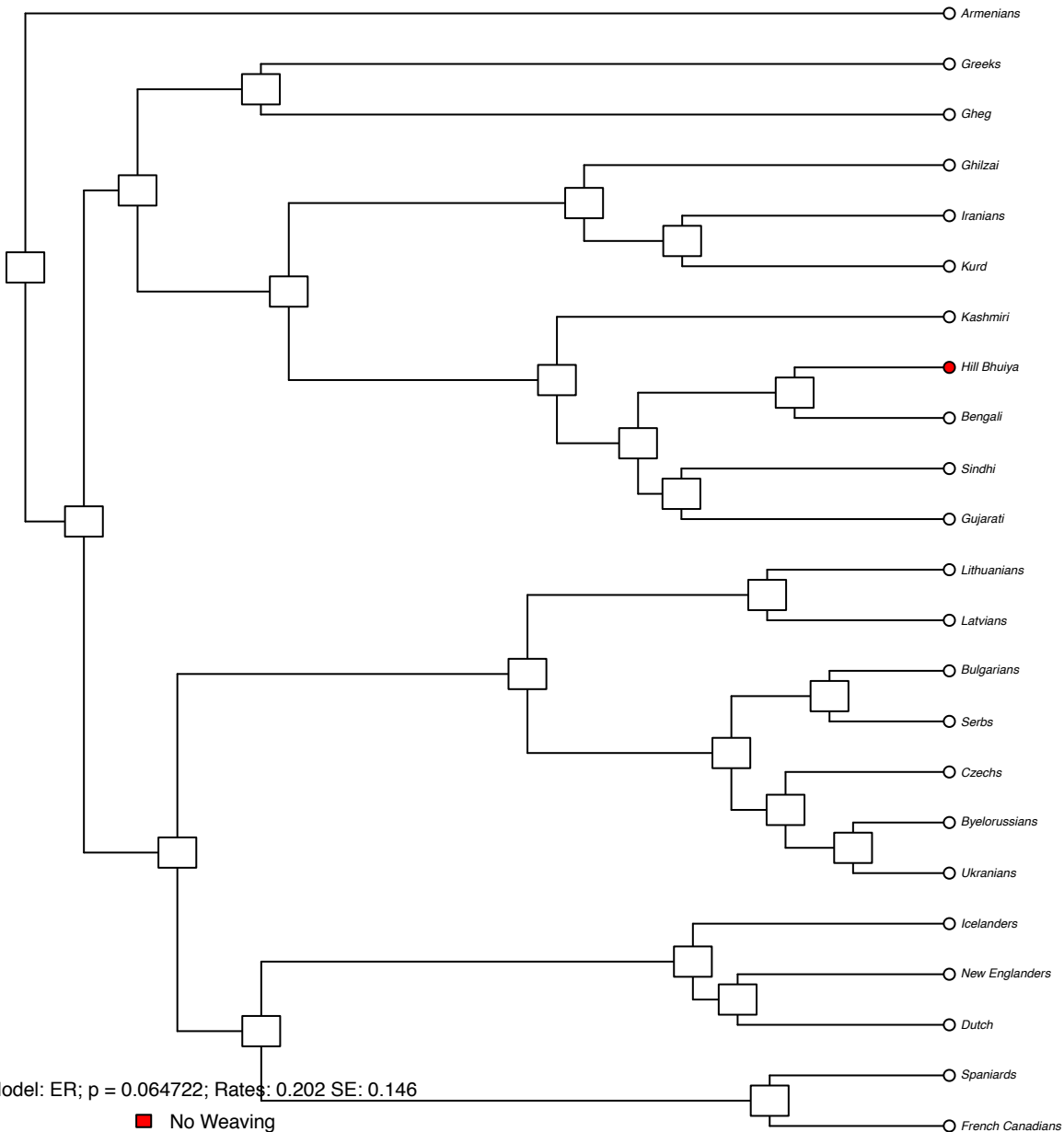

- Armenians
- Greeks
- Ghag
- Ghizai
- Iranians
- Kurd
- Kashmiri
- Hill Bhuiya
- Bengali
- Sindhi
- Gujarati
- Lithuanians
- Latvians
- Bulgarians
- Serbs
- Czechs
- Byelorussians
- Ukrainians
- Icelanders
- New Englanders
- Dutch
- Spaniards
- French Canadians

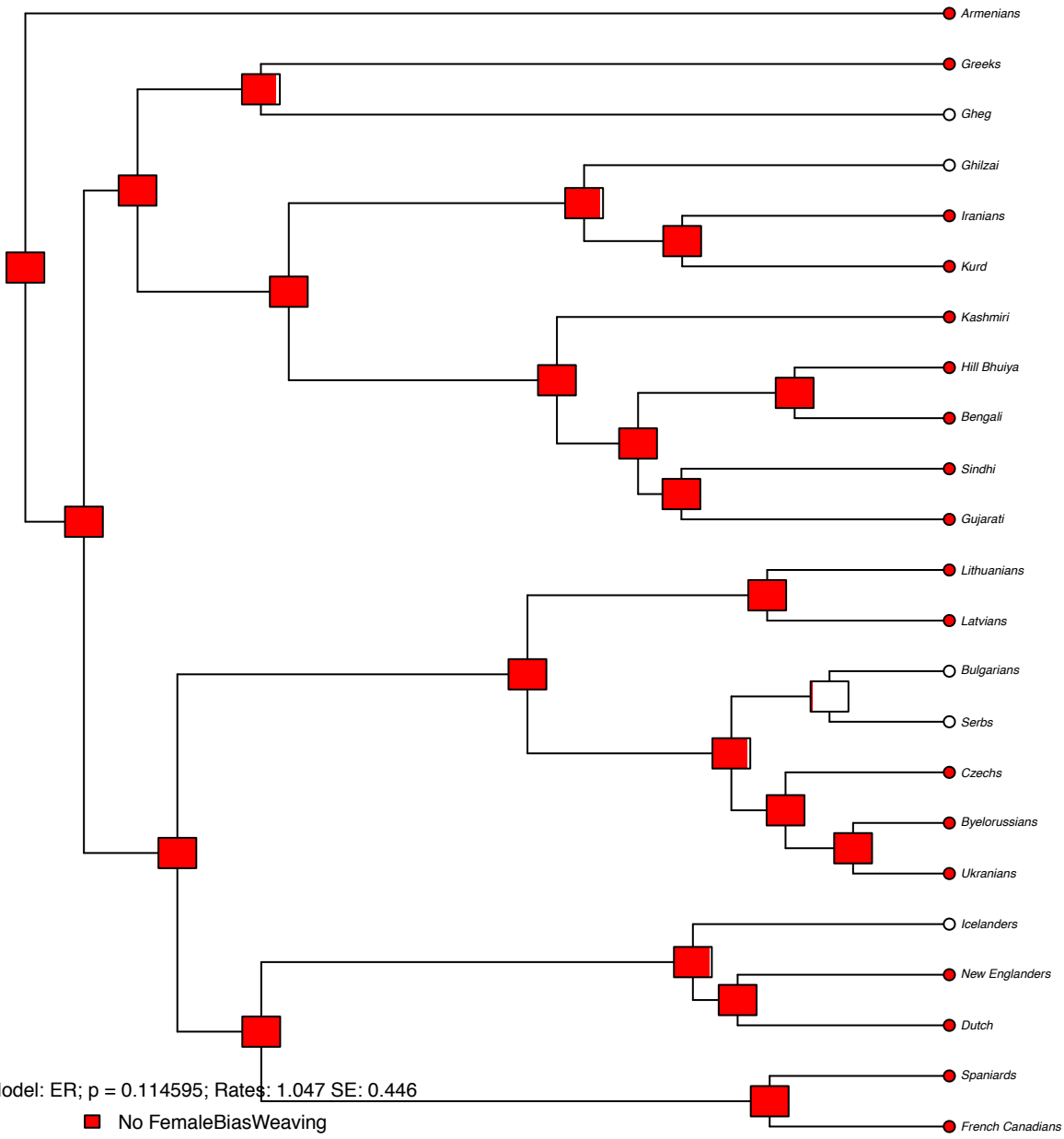

- Armenians
- Greeks
- Ghag
- Ghizai
- Iranians
- Kurd
- Kashmiri
- Hill Bhuiya
- Bengali
- Sindhi
- Gujarati
- Lithuanians
- Latvians
- Bulgarians
- Serbs
- Czechs
- Byelorussians
- Ukrainians
- Icelanders
- New Englanders
- Dutch
- Spaniards
- French Canadians

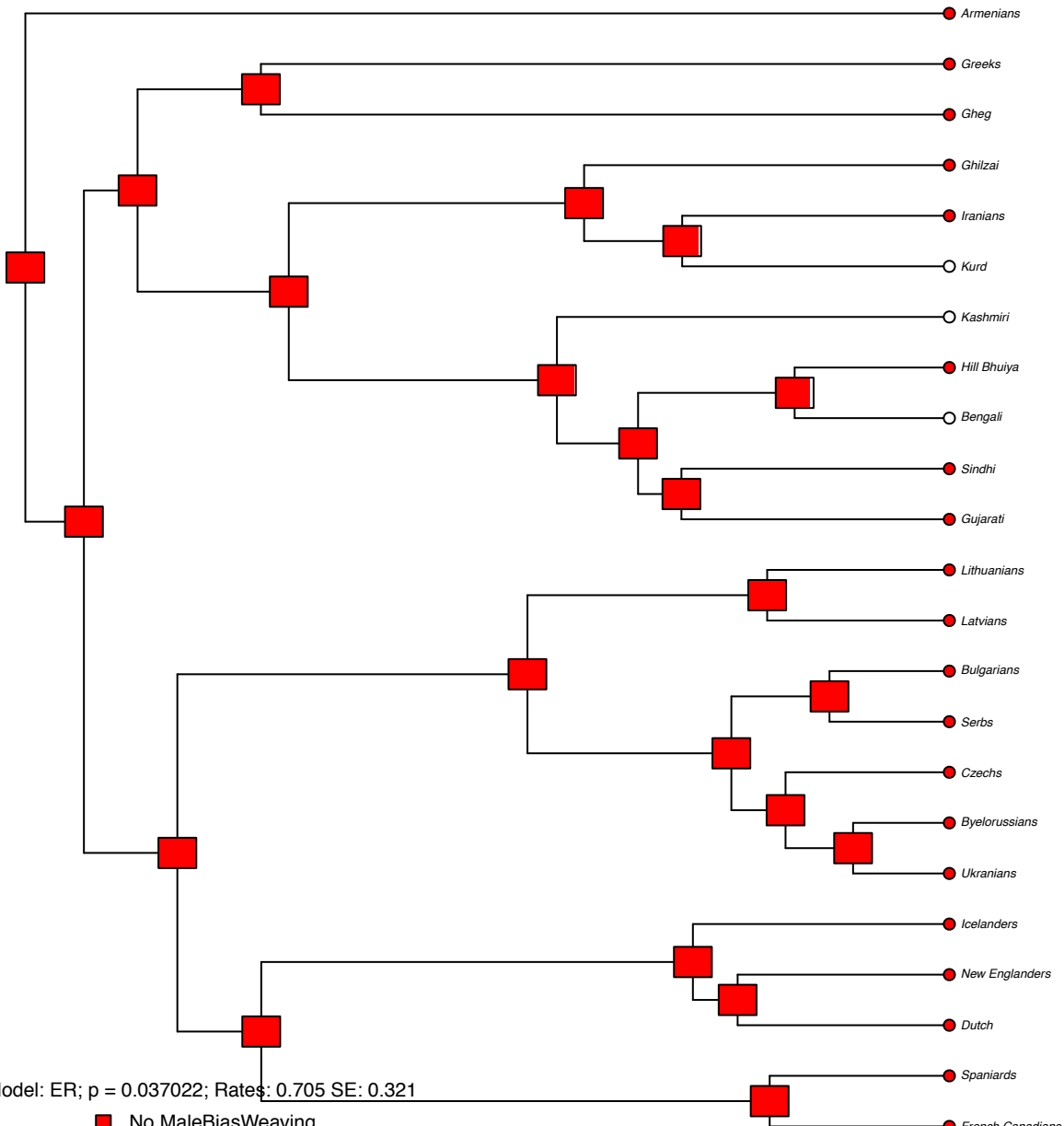

- Armenians
- Greeks
- Ghag
- Ghizai
- Iranians
- Kurd
- Kashmiri
- Hill Bhuiya
- Bengali
- Sindhi
- Gujarati
- Lithuanians
- Latvians
- Bulgarians
- Serbs
- Czechs
- Byelorussians
- Ukrainians
- Icelanders
- New Englanders
- Dutch
- Spaniards
- French Canadians

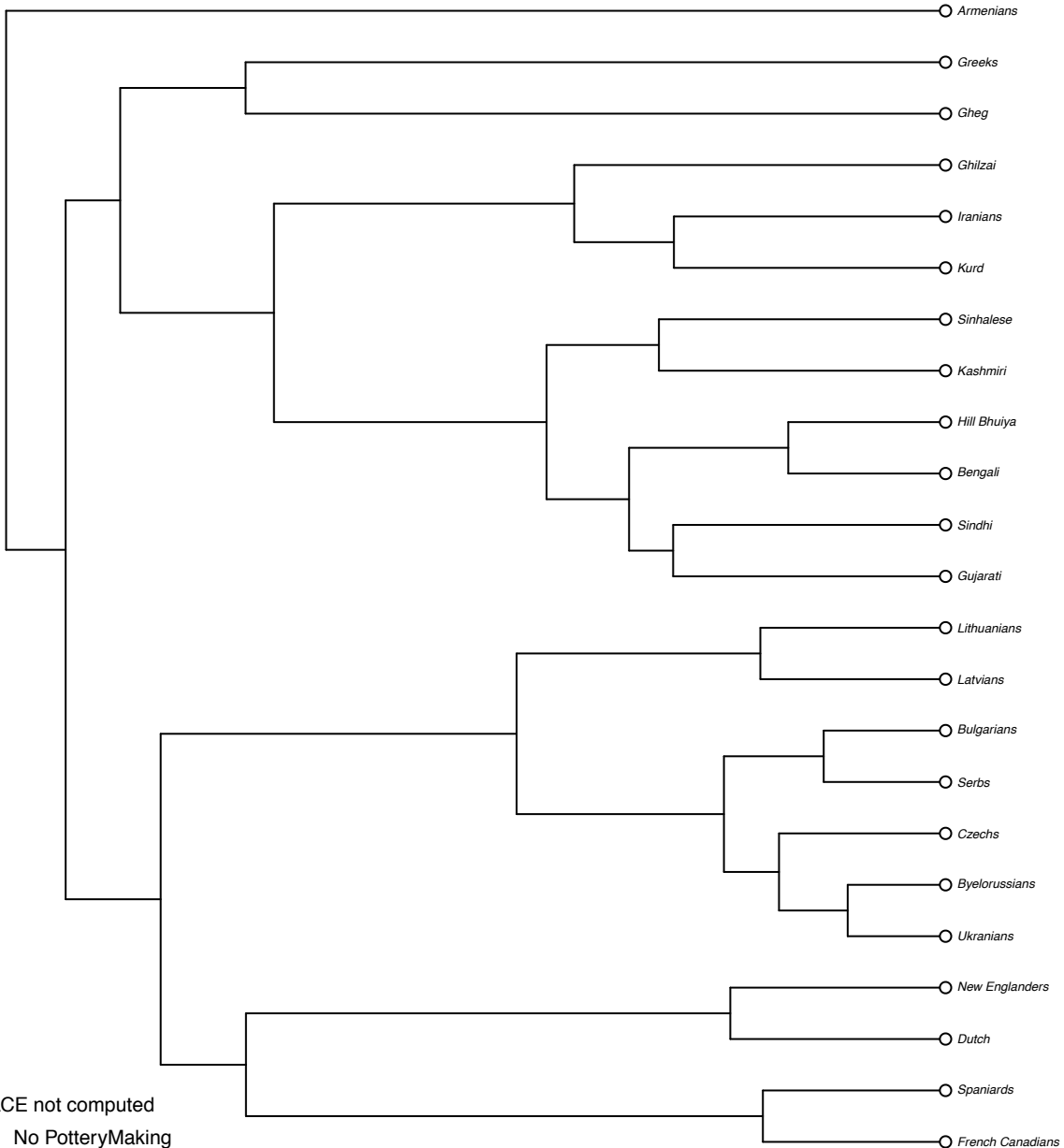

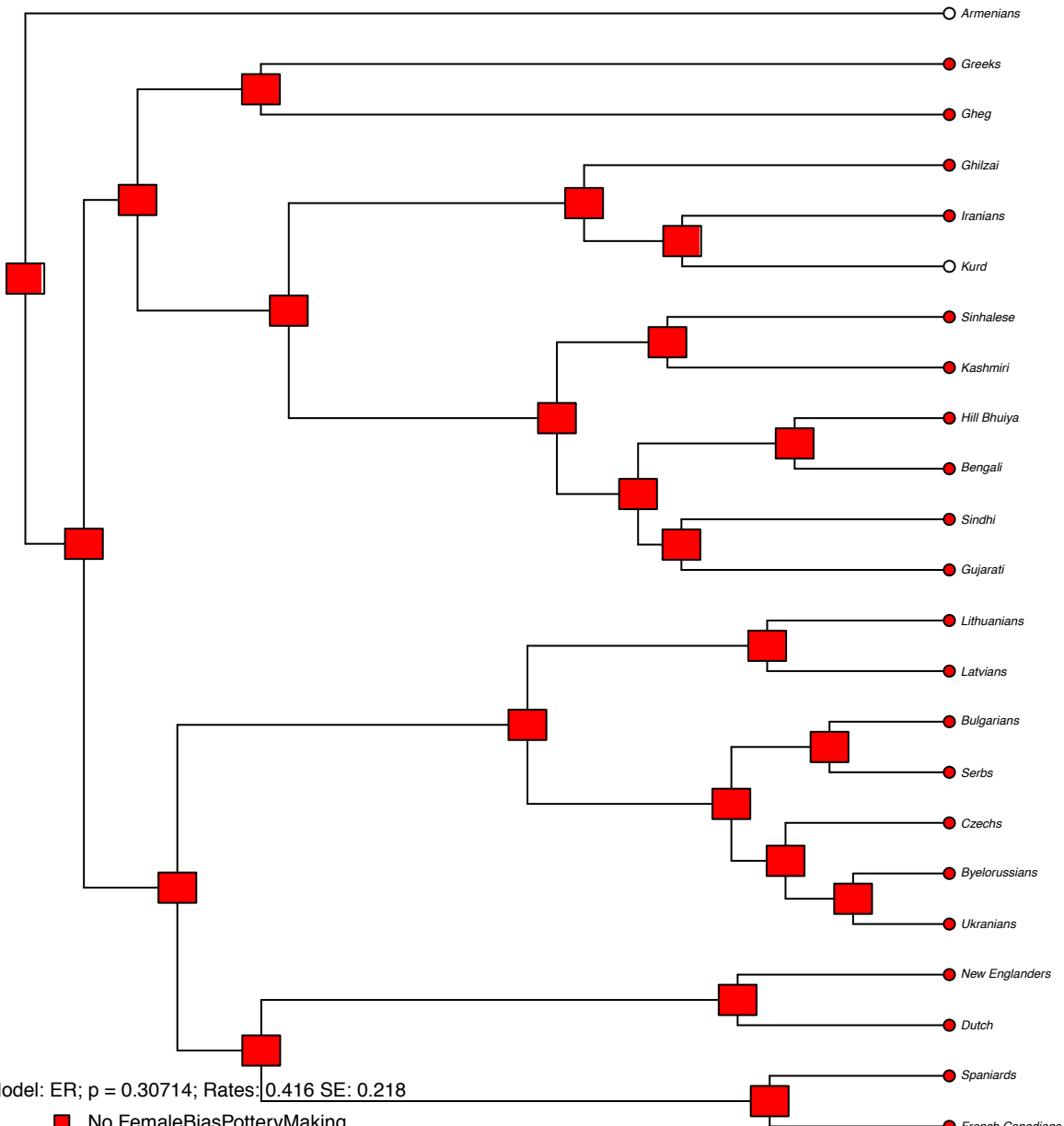

Model: ER; $p = 0.30714$; Rates: 0.416 SE: 0.218

- No FemaleBiasPotteryMaking
- FemaleBiasPotteryMaking

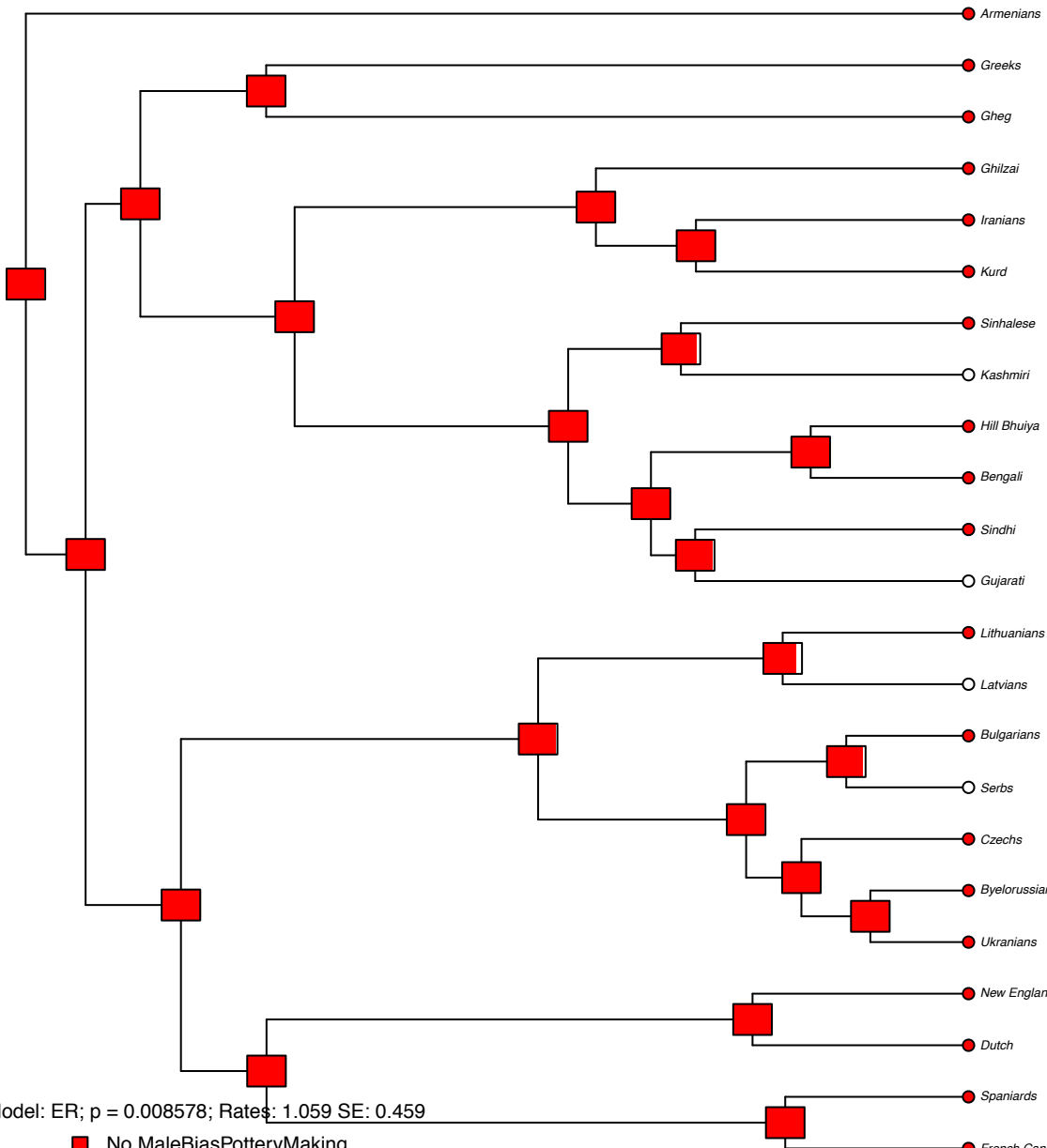

No MaleBiasPotteryMaking
 MaleBiasPotteryMaking

- Armenians
- Greeks
- Ghag
- Ghilzai
- Iranians
- Kurd
- Sinhalese
- Kashmiri
- Hill Bhuiya
- Bengali
- Sindhi
- Gujarati
- Lithuanians
- Latvians
- Bulgarians
- Serbs
- Czechs
- Byelorussians
- Ukrainians
- New Englanders
- Dutch
- Spaniards
- French Canadians

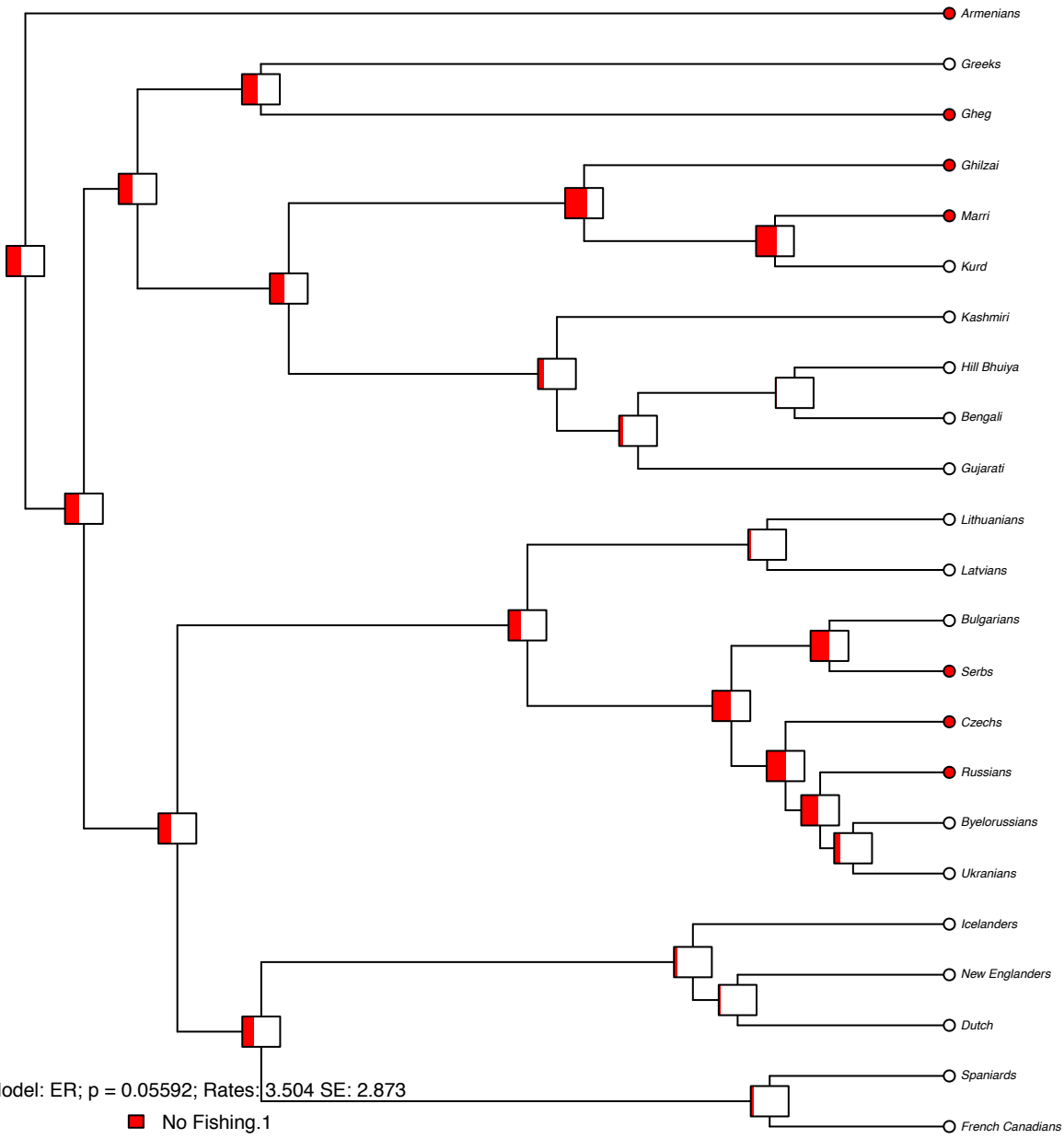

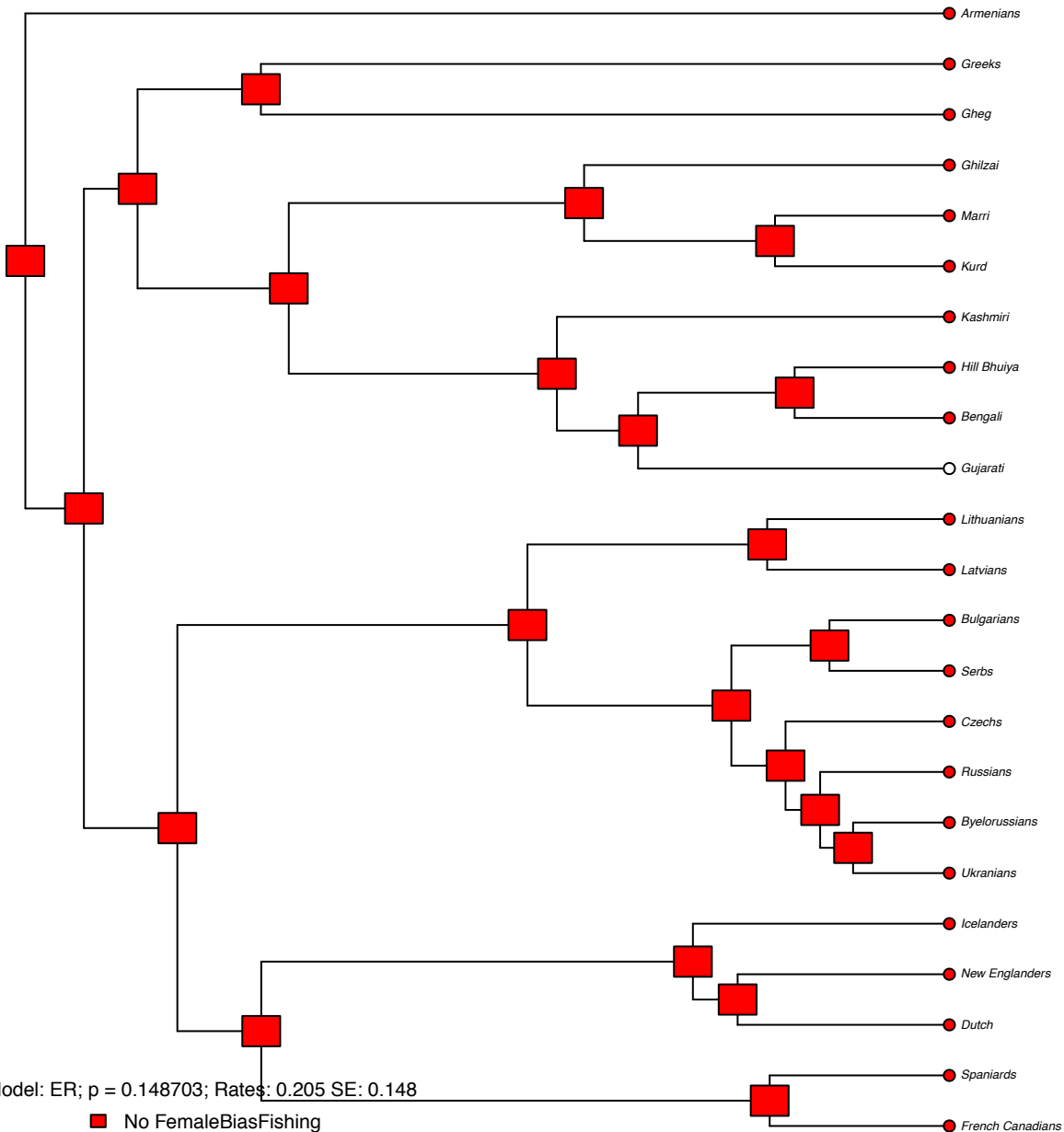

Armenians

Greeks

Ghag

Ghilzai

Marri

Kurd

Kashmiri

Hill Bhuiya

Bengali

Gujarati

Lithuanians

Latvians

Bulgarians

Serbs

Czechs

Russians

Byelorussians

Ukrainians

Icelanders

New Englanders

Dutch

Spaniards

French Canadians

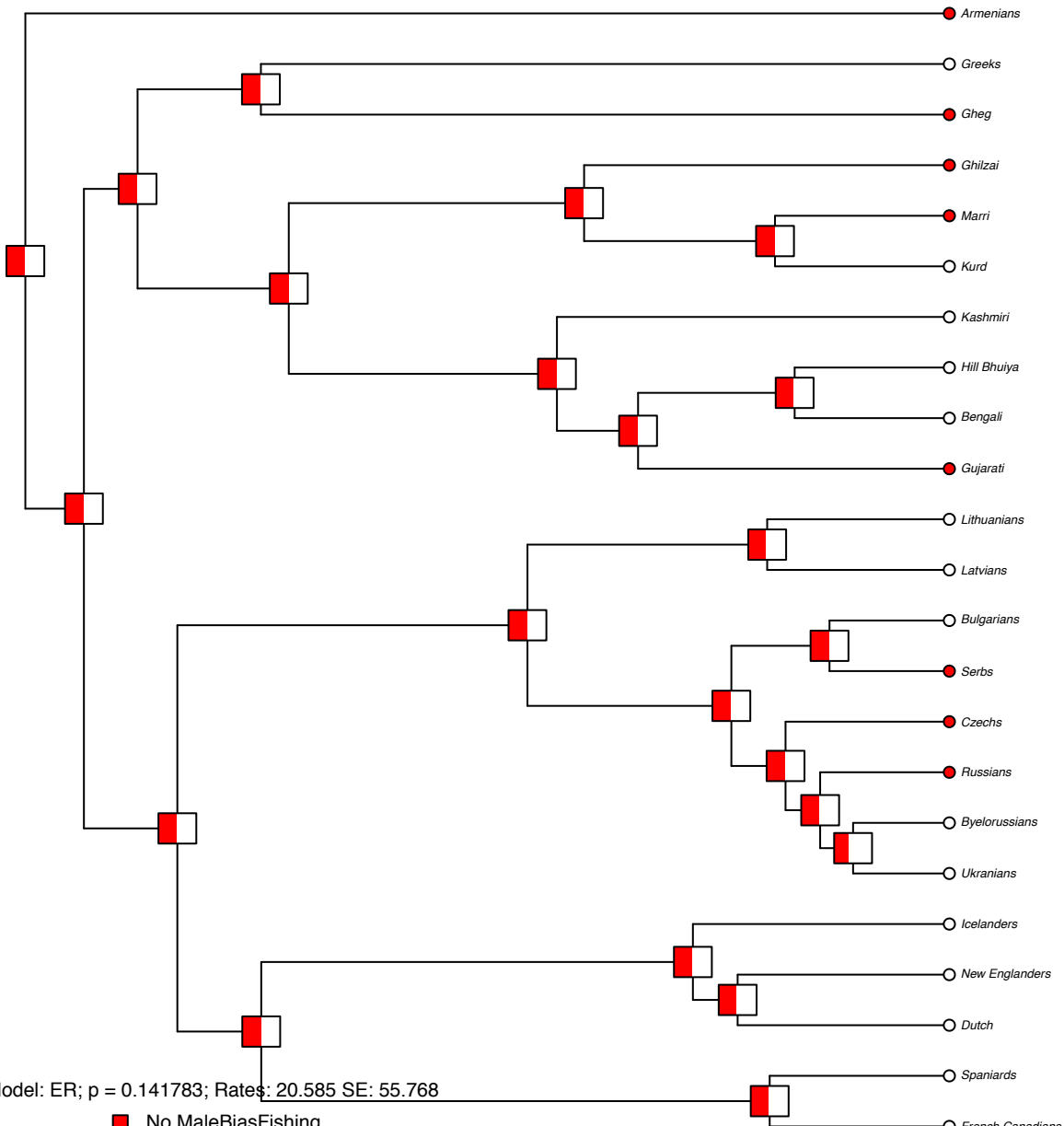

Model: ER; $p = 0.141783$; Rates: 20.585 SE: 55.768

■ No MaleBiasFishing
 MaleBiasFishing

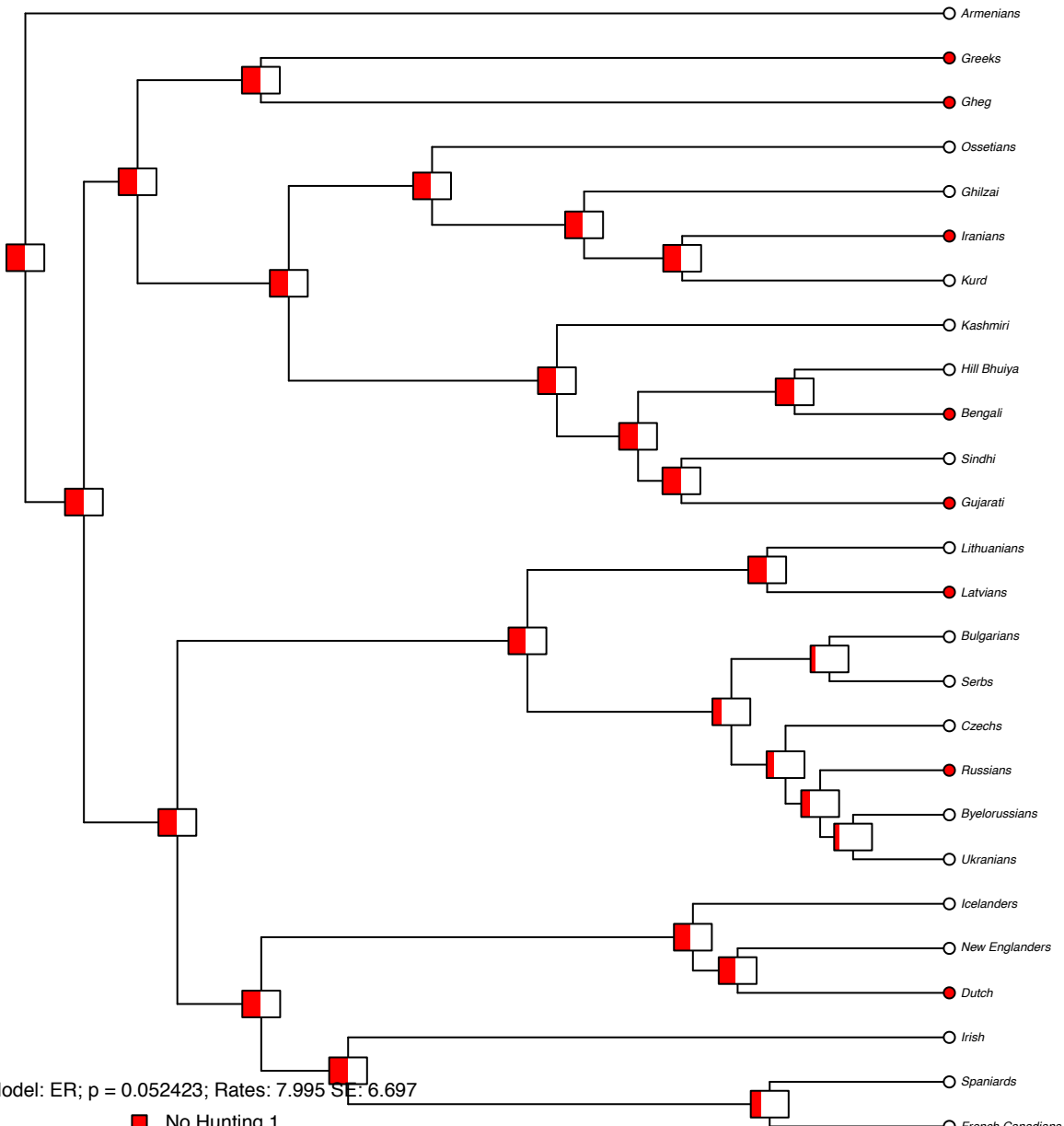

Model: ER; $p = 0.052423$; Rates: 7.995 SE: 6.697

■ No Hunting.1
 □ Hunting.1

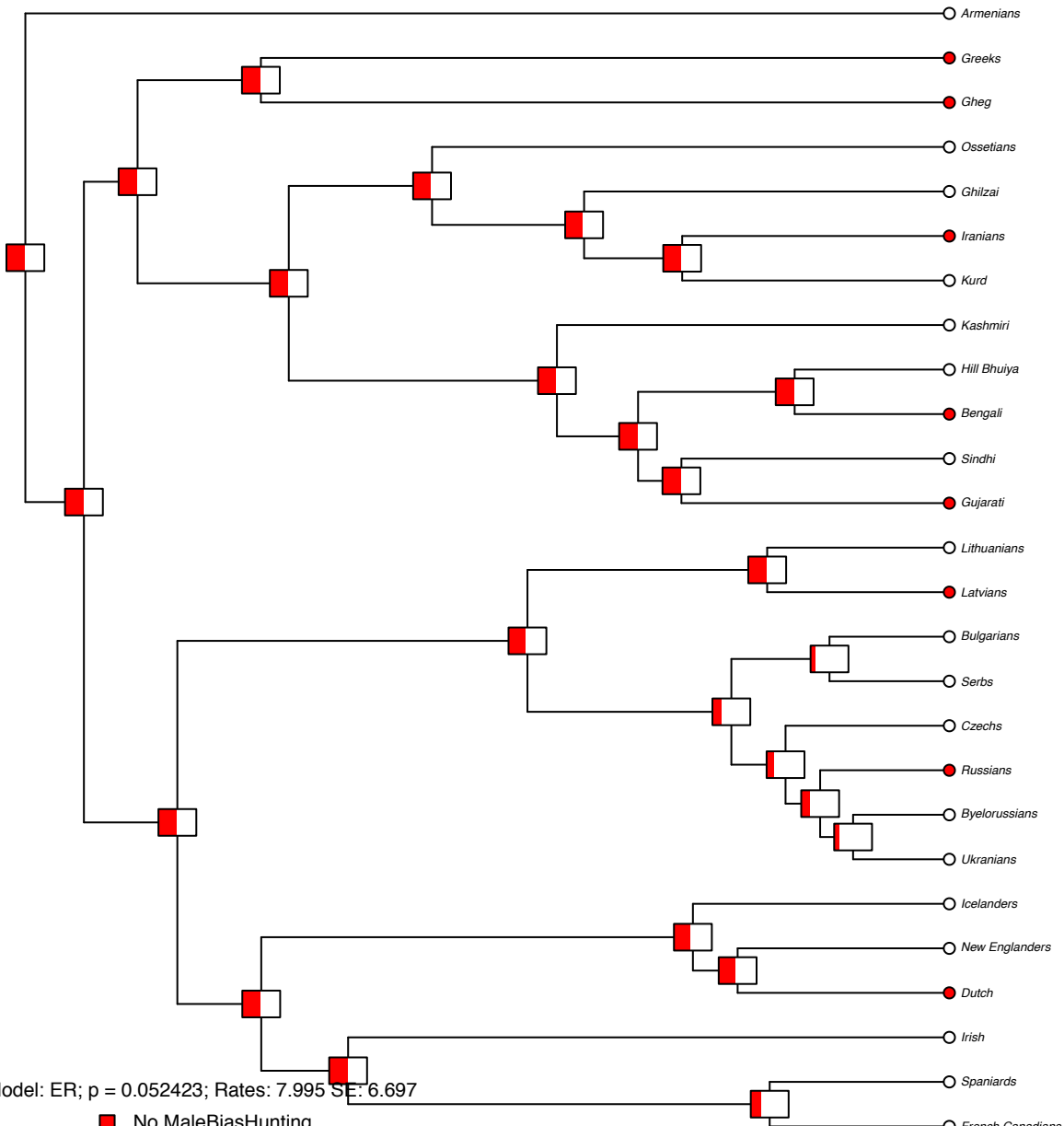

Model: ER; $p = 0.052423$; Rates: 7.995 SE: 6.697

■ No MaleBiasHunting
 MaleBiasHunting

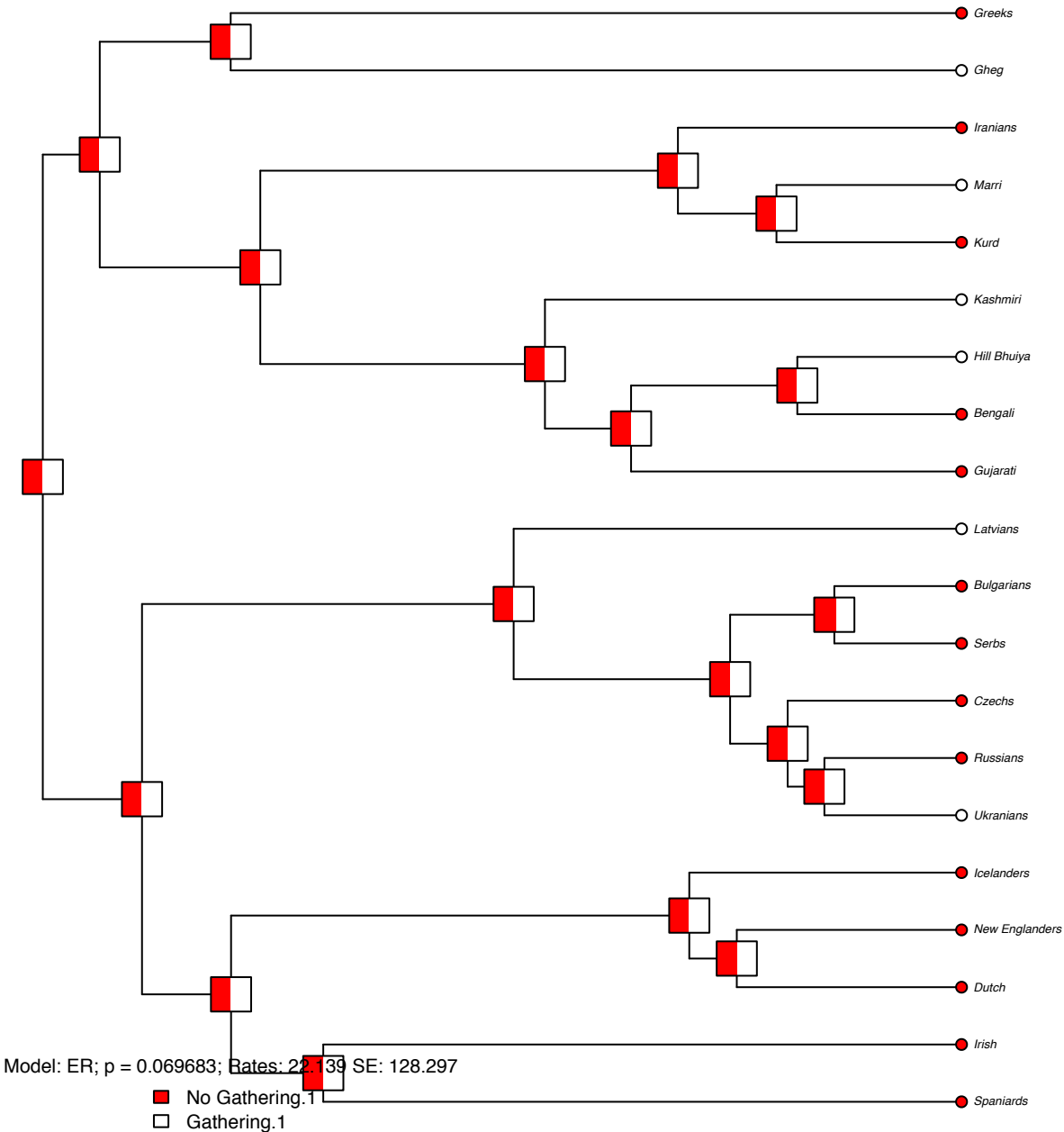

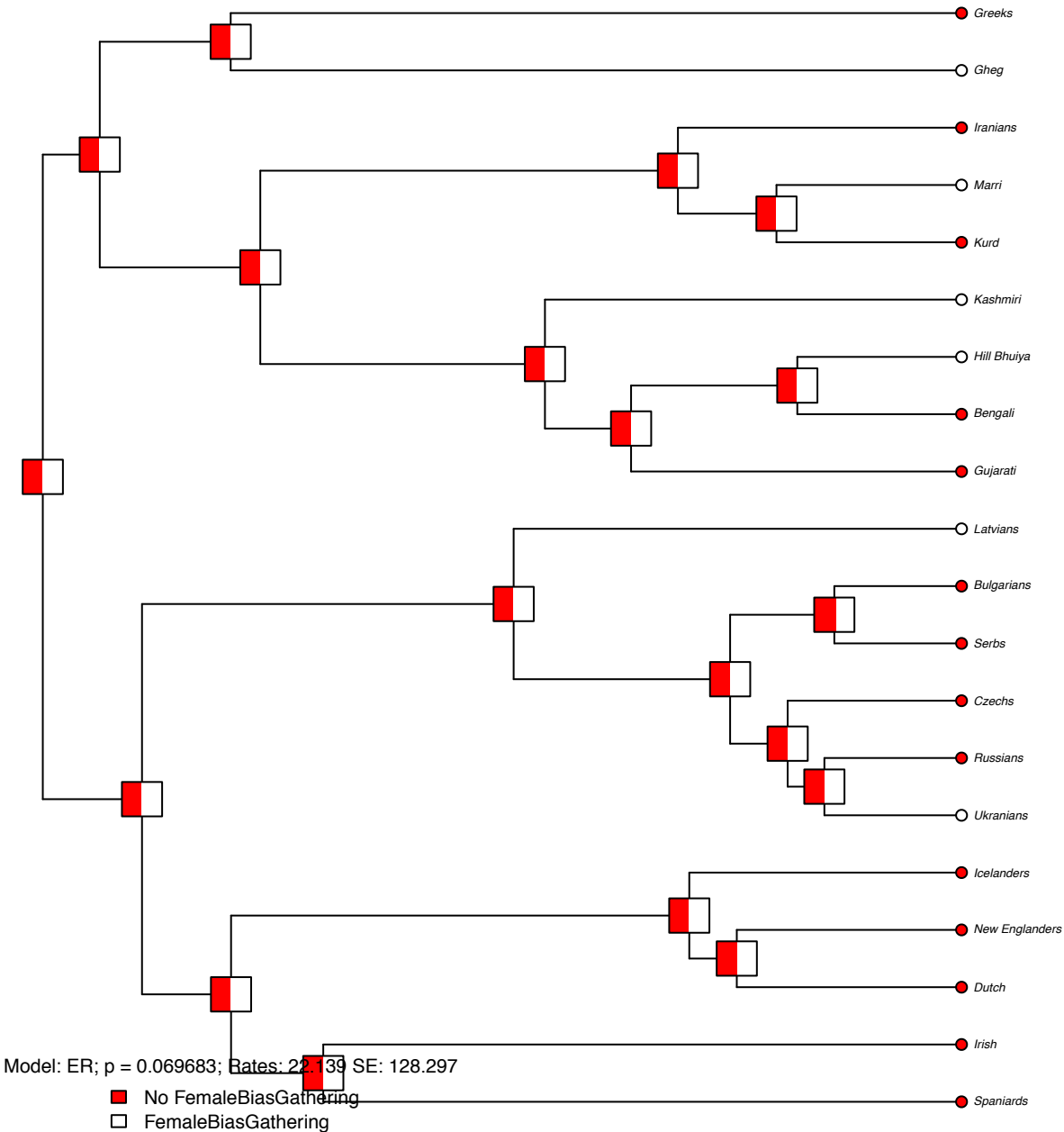

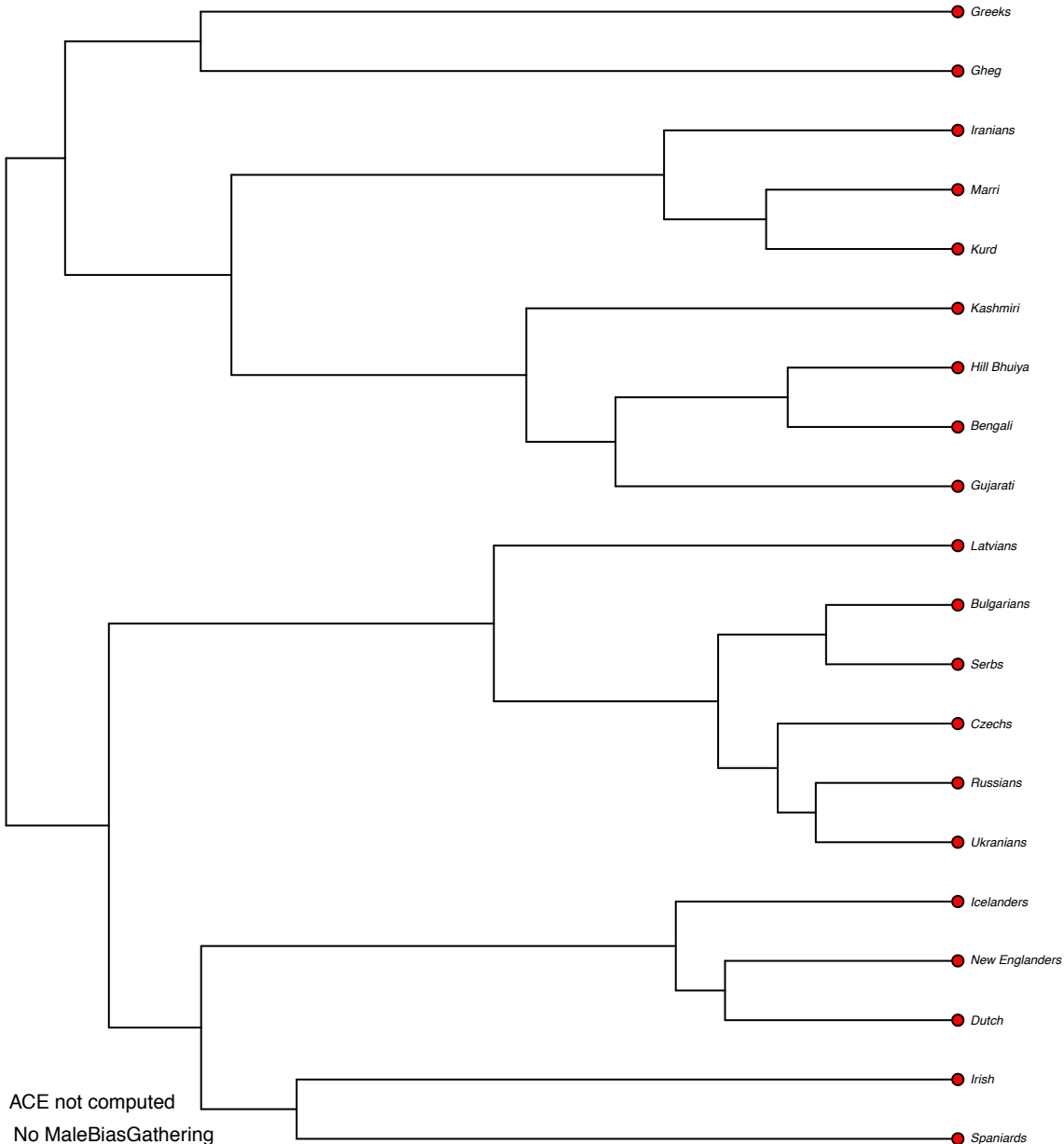

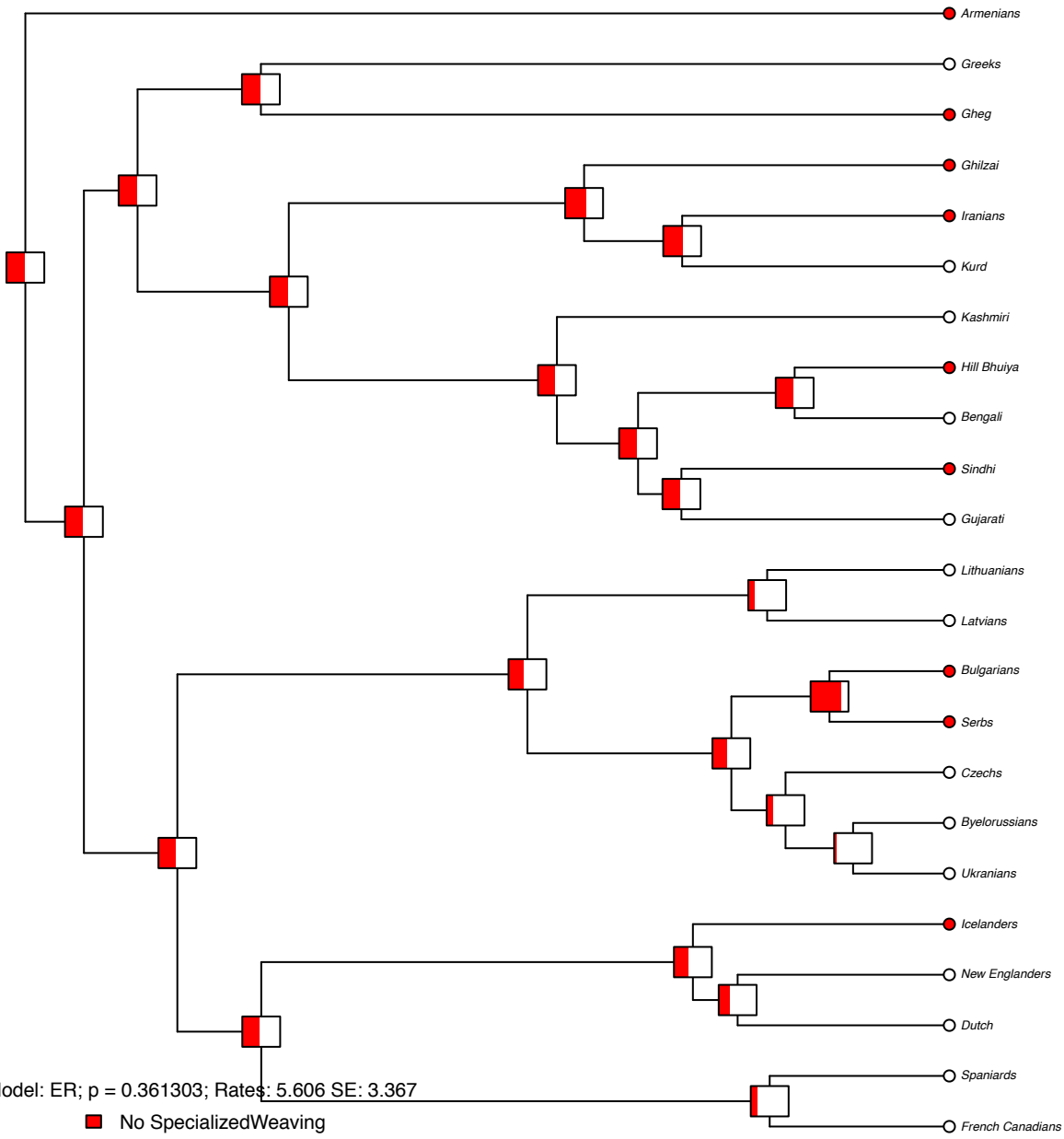

Model: ER; $p = 0.361303$; Rates: 5.606 SE: 3.367

■ No SpecializedWeaving
 SpecializedWeaving

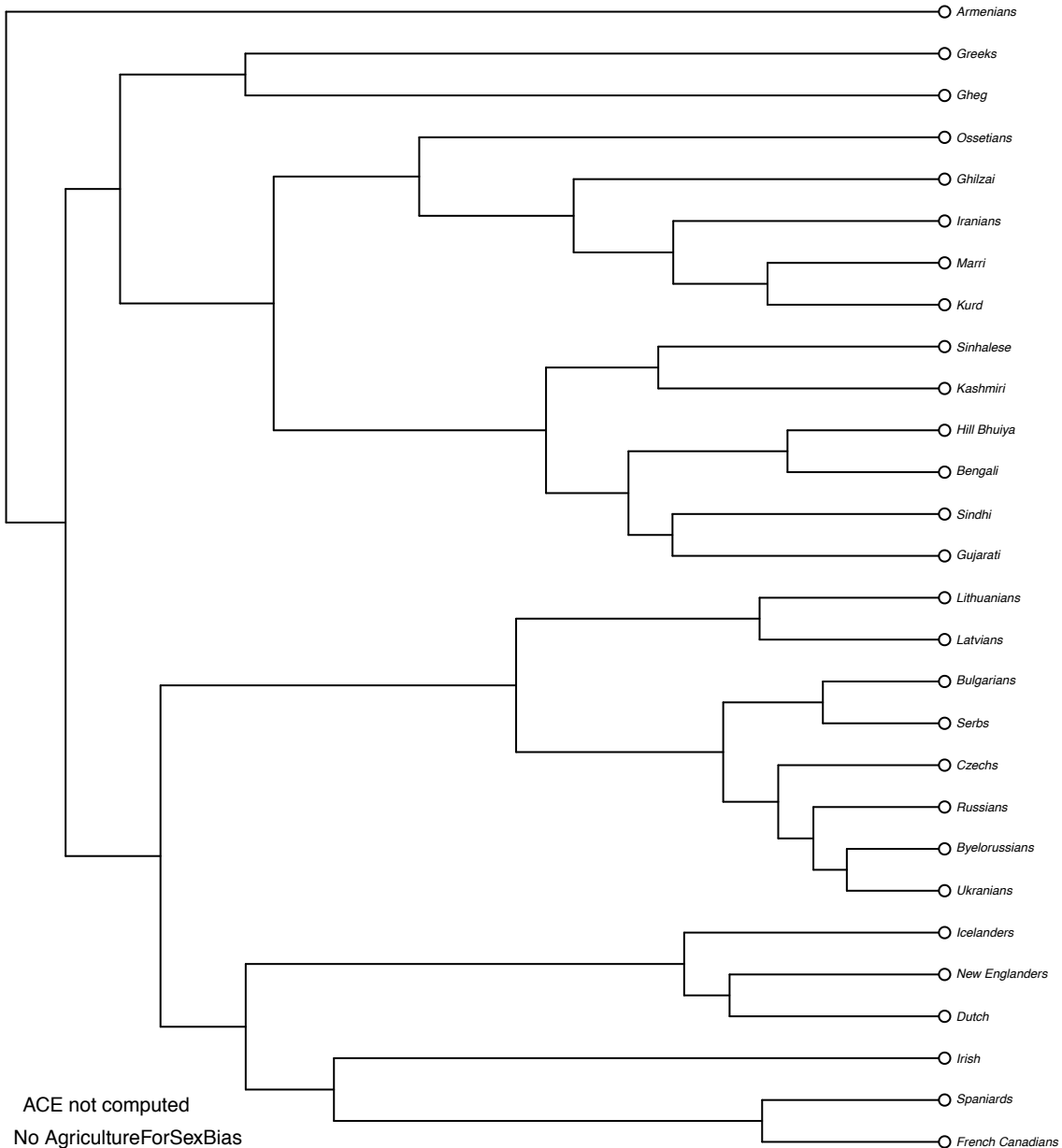

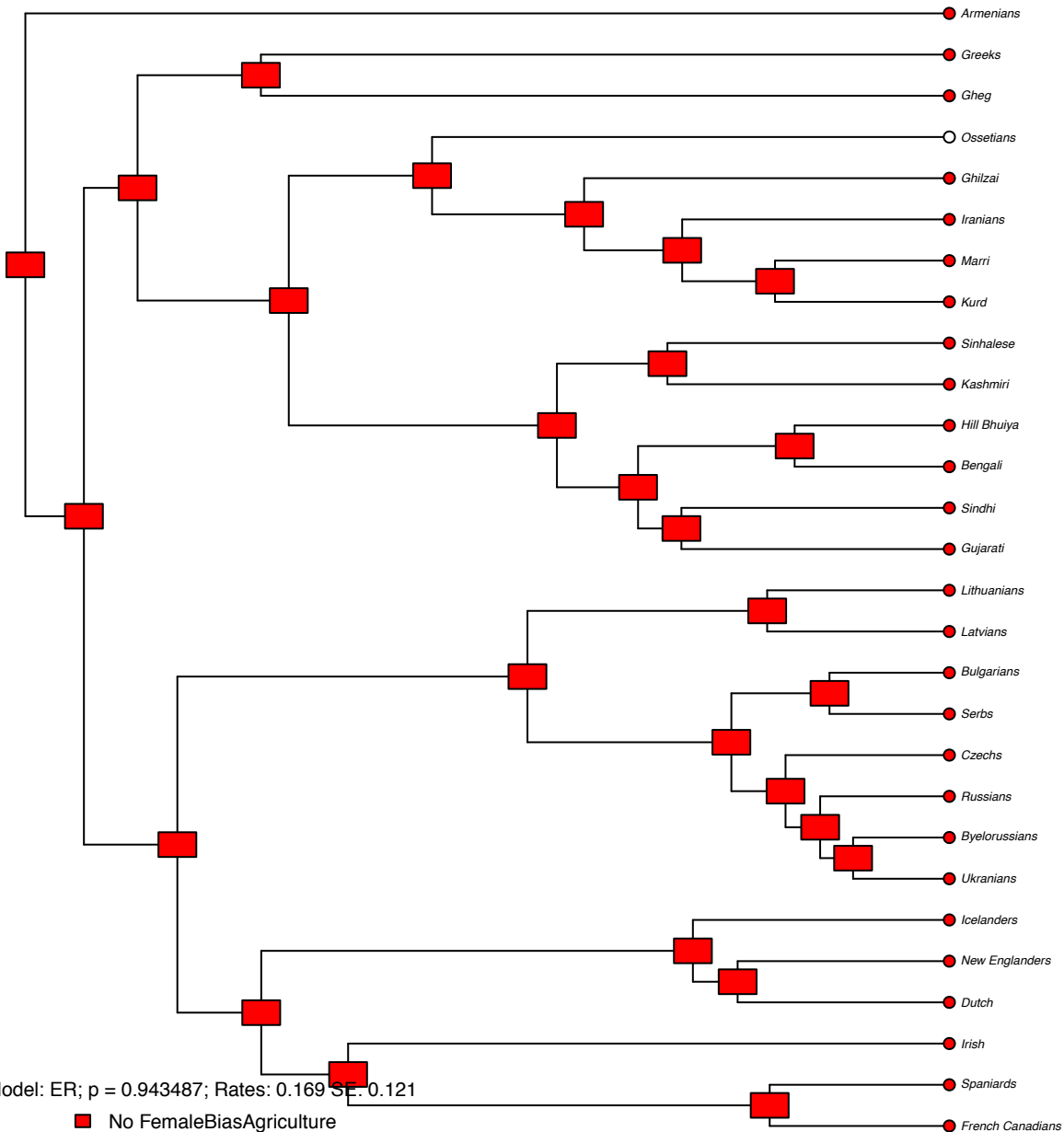

- Armenians
- Greeks
- Ghzeg
- Ossetians
- Ghilzai
- Iranians
- Marri
- Kurd
- Sinhalese
- Kashmiri
- Hill Bhuiya
- Bengali
- Sindhi
- Gujarati
- Lithuanians
- Latvians
- Bulgarians
- Serbs
- Czechs
- Russians
- Byelorussians
- Ukrainians
- Icelanders
- New Englanders
- Dutch
- Irish
- Spaniards
- French Canadians

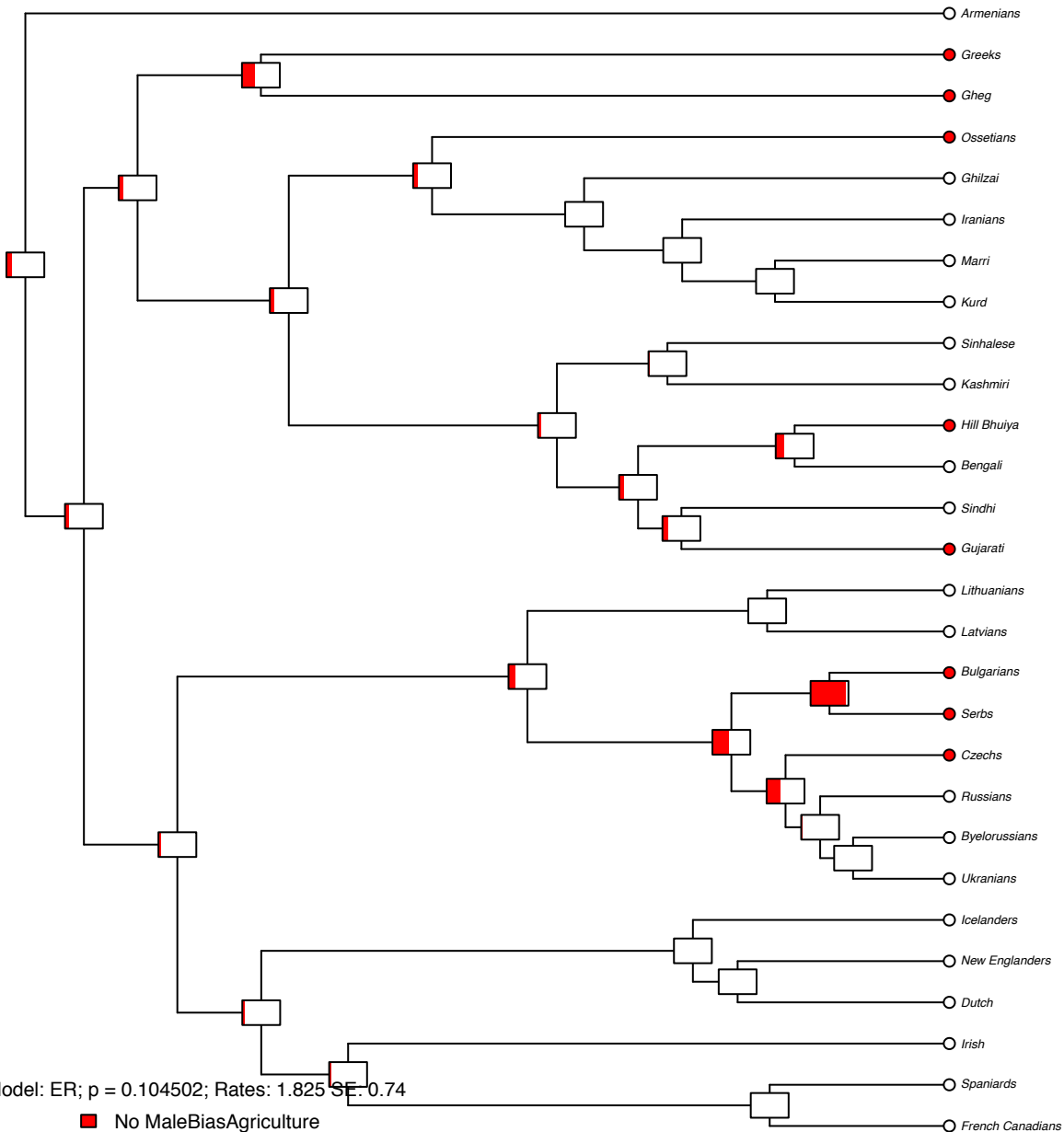

Model: ER; $p = 0.104502$; Rates: 1.825 SE: 0.74

- No MaleBiasAgriculture
- MaleBiasAgriculture

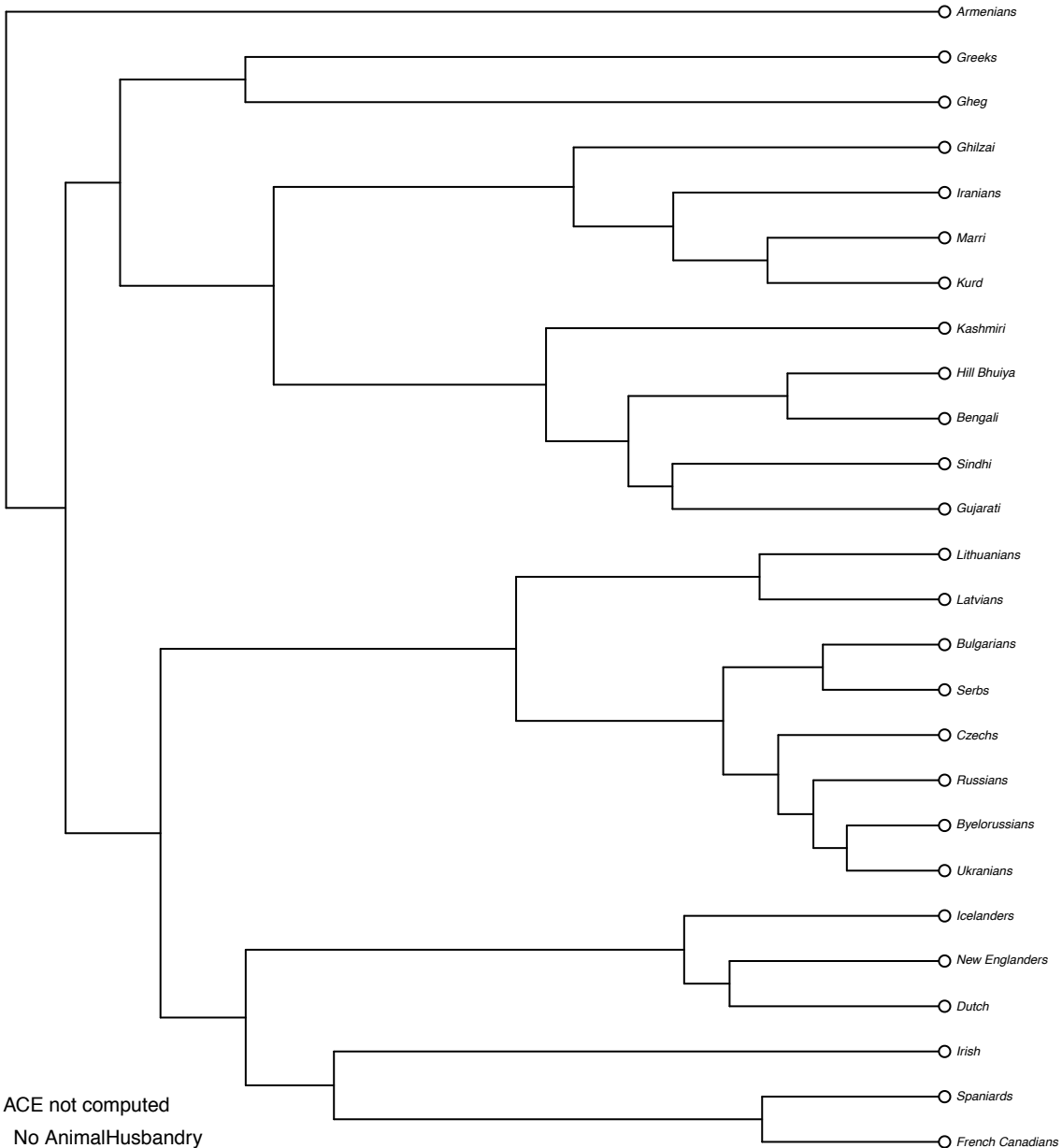

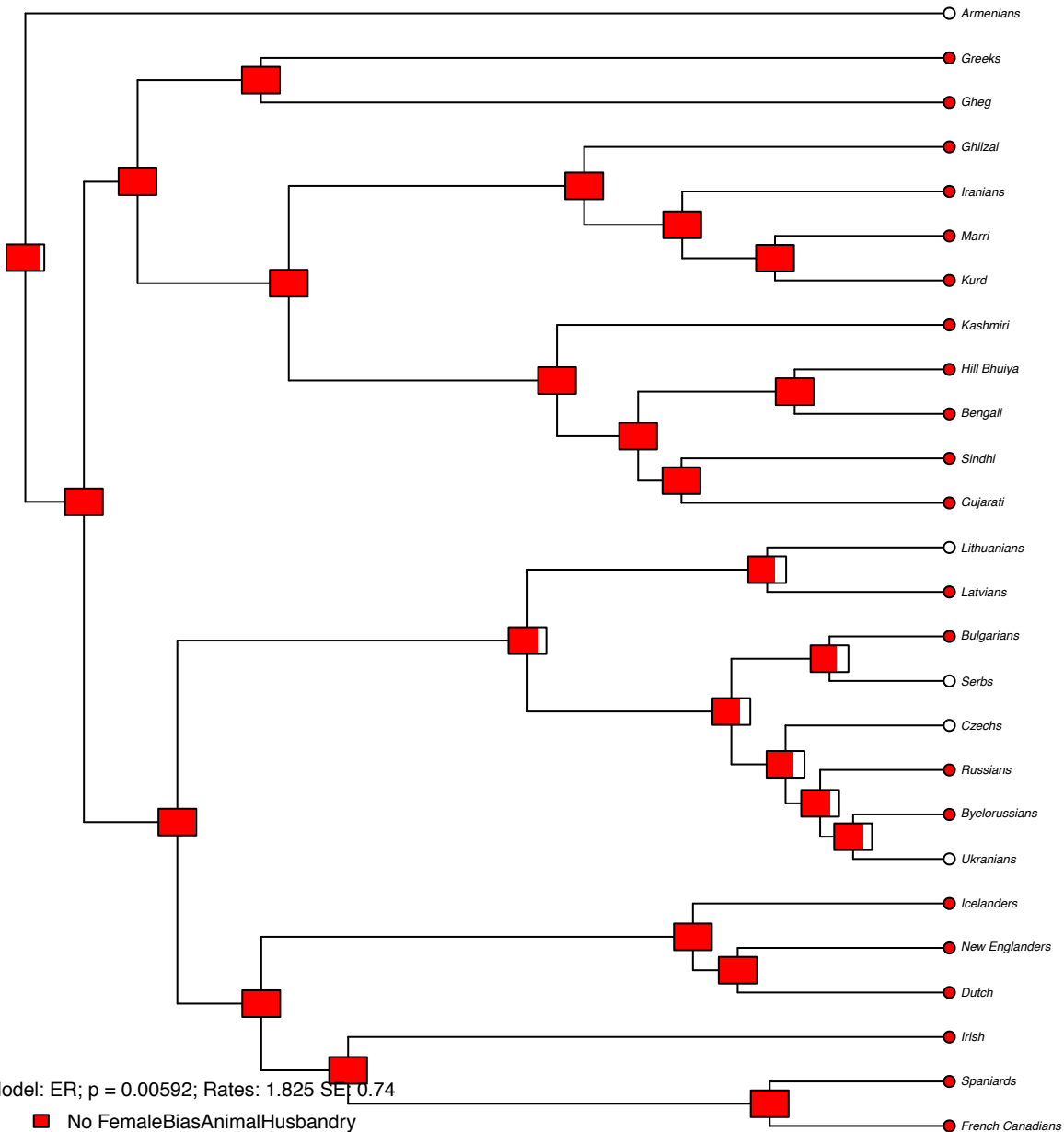

- Armenians
- Greeks
- Gheg
- Ghilzai
- Iranians
- Marri
- Kurd
- Kashmiri
- Hill Bhuiya
- Bengali
- Sindhi
- Gujarati
- Lithuanians
- Latvians
- Bulgarians
- Serbs
- Czechs
- Russians
- Byelorussians
- Ukrainians
- Icelanders
- New Englanders
- Dutch
- Irish
- Spaniards
- French Canadians

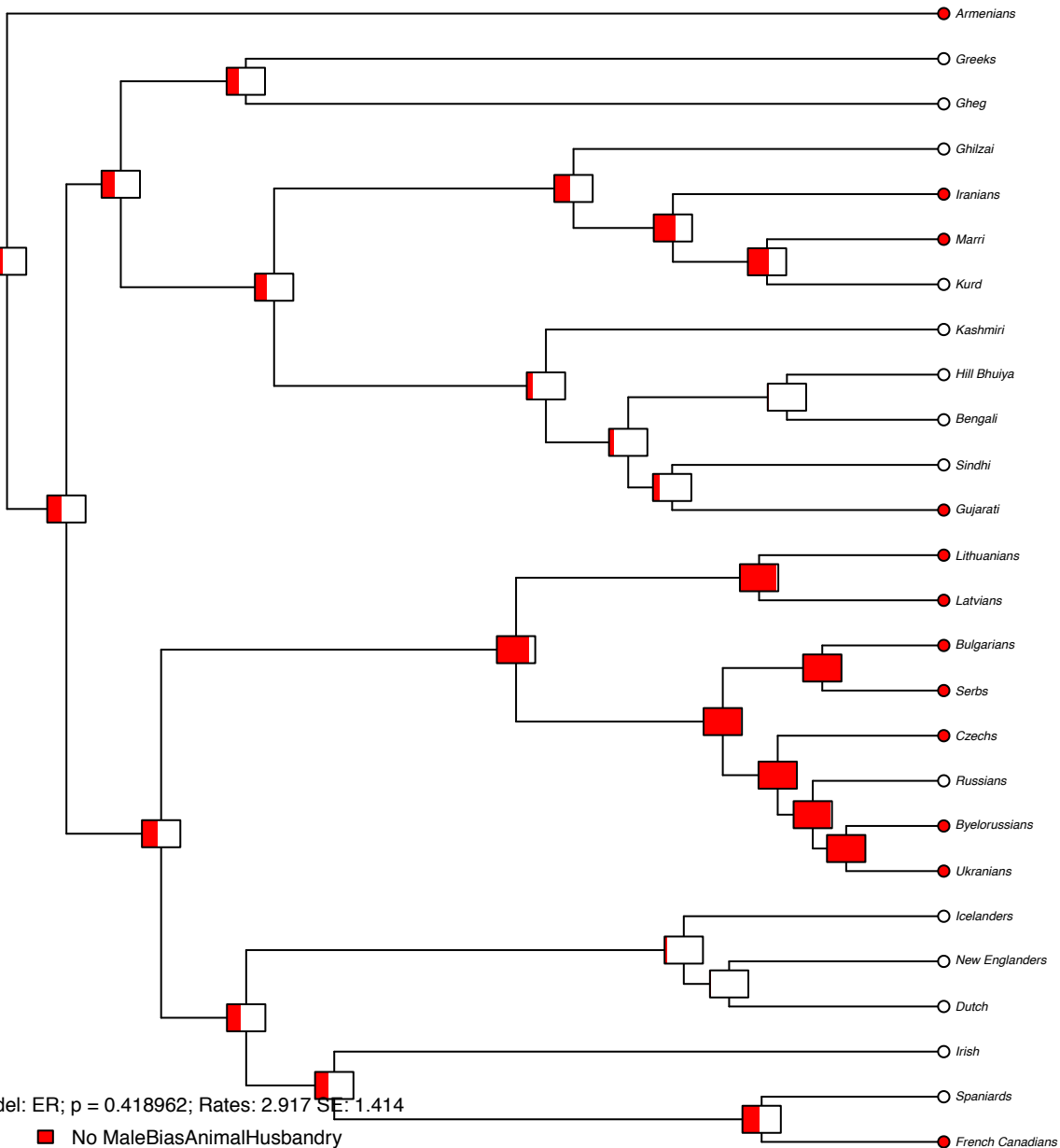

- Armenians
- Greeks
- Ghag
- Ghilzai
- Iranians
- Marri
- Kurd
- Kashmiri
- Hill Bhuiya
- Bengali
- Sindhi
- Gujarati
- Lithuanians
- Latvians
- Bulgarians
- Serbs
- Czechs
- Russians
- Byelorussians
- Ukrainians
- Icelanders
- New Englanders
- Dutch
- Irish
- Spaniards
- French Canadians

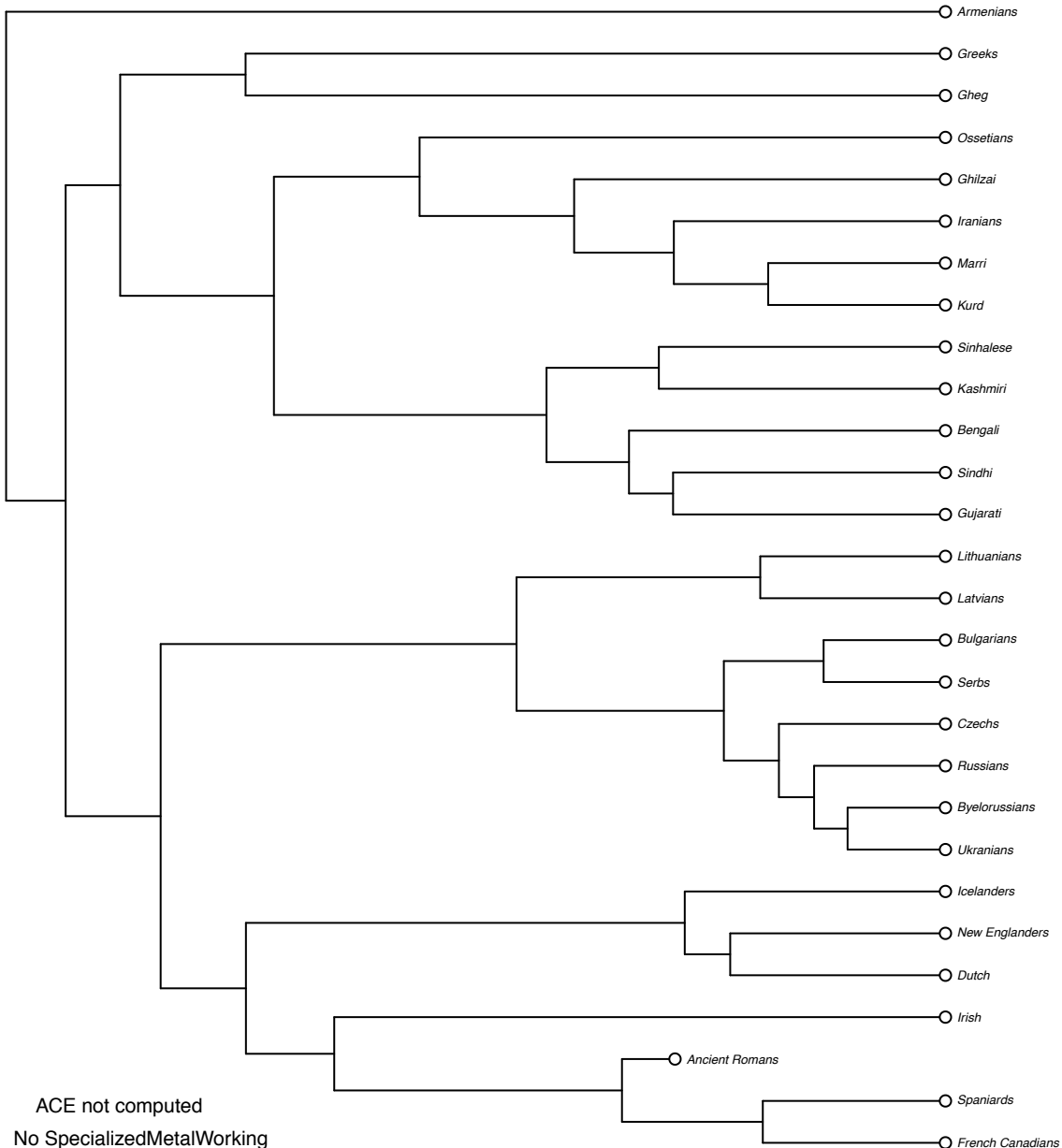

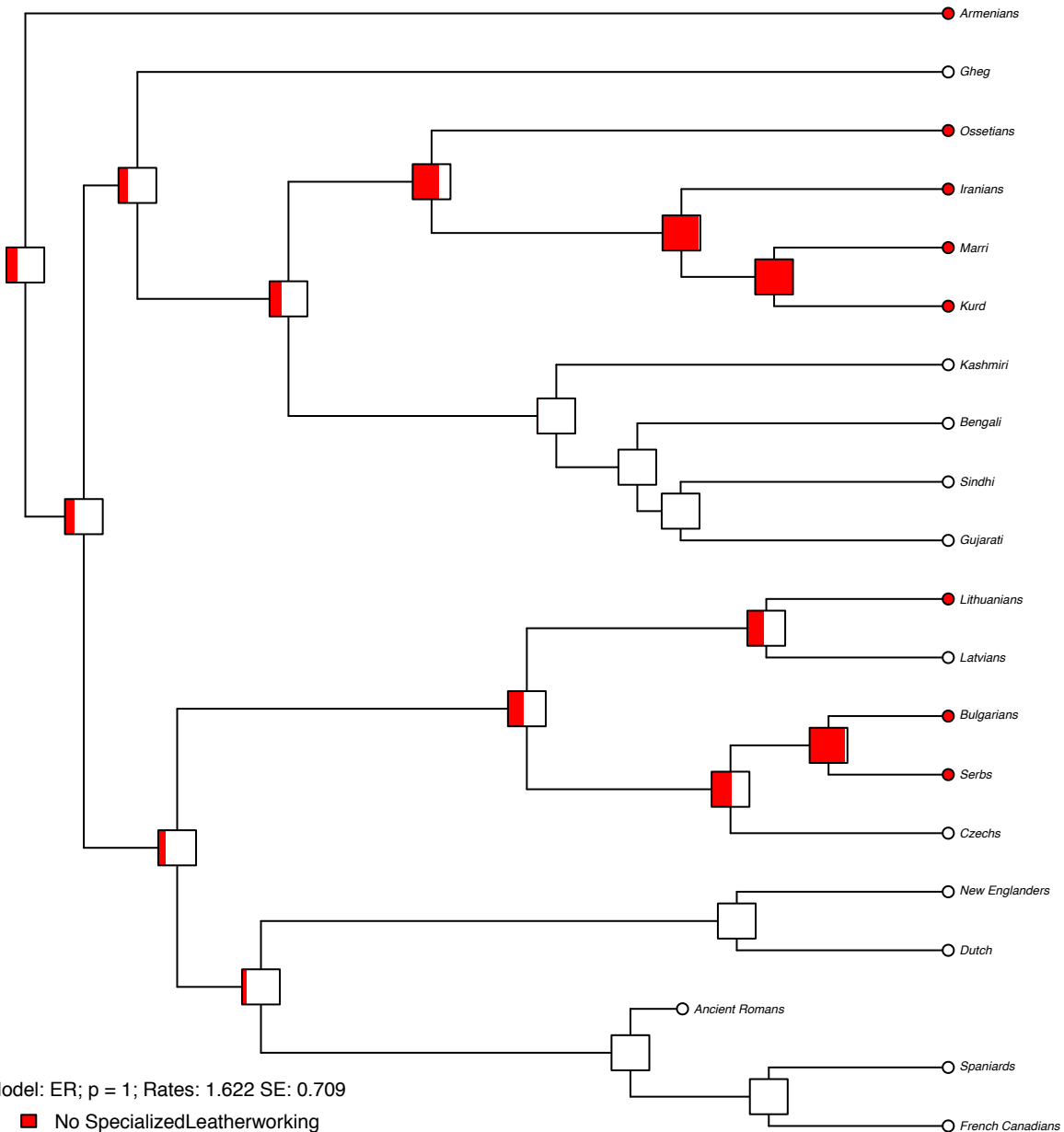

Model: ER; $p = 1$; Rates: 1.622 SE: 0.709

- No SpecializedLeatherworking
- SpecializedLeatherworking

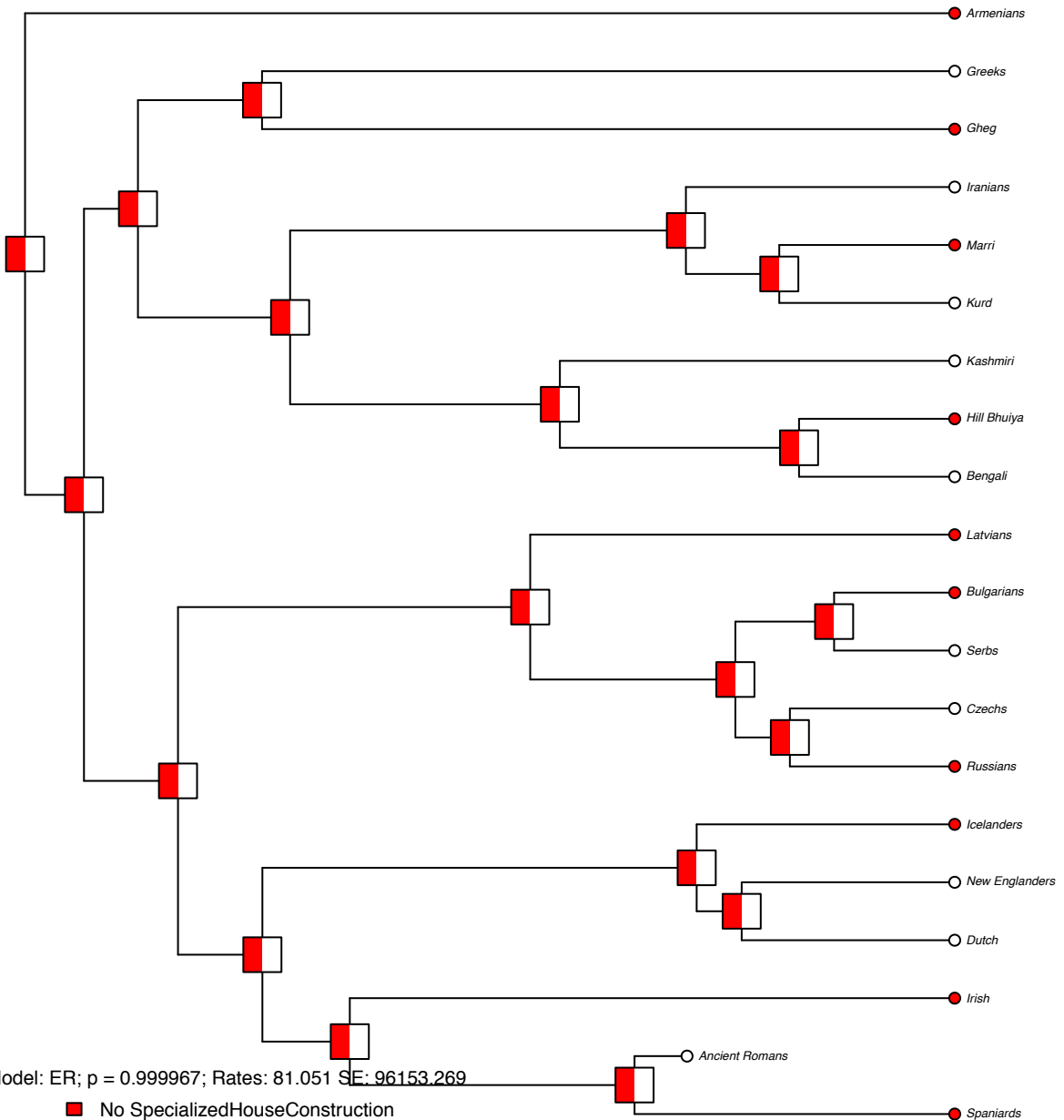

- Armenians
- Greeks
- Ghag
- Iranians
- Marri
- Kurd
- Kashmiri
- Hill Bhuiya
- Bengali
- Latvians
- Bulgarians
- Serbs
- Czechs
- Russians
- Icelanders
- New Englanders
- Dutch
- Irish
- Ancient Romans
- Spaniards

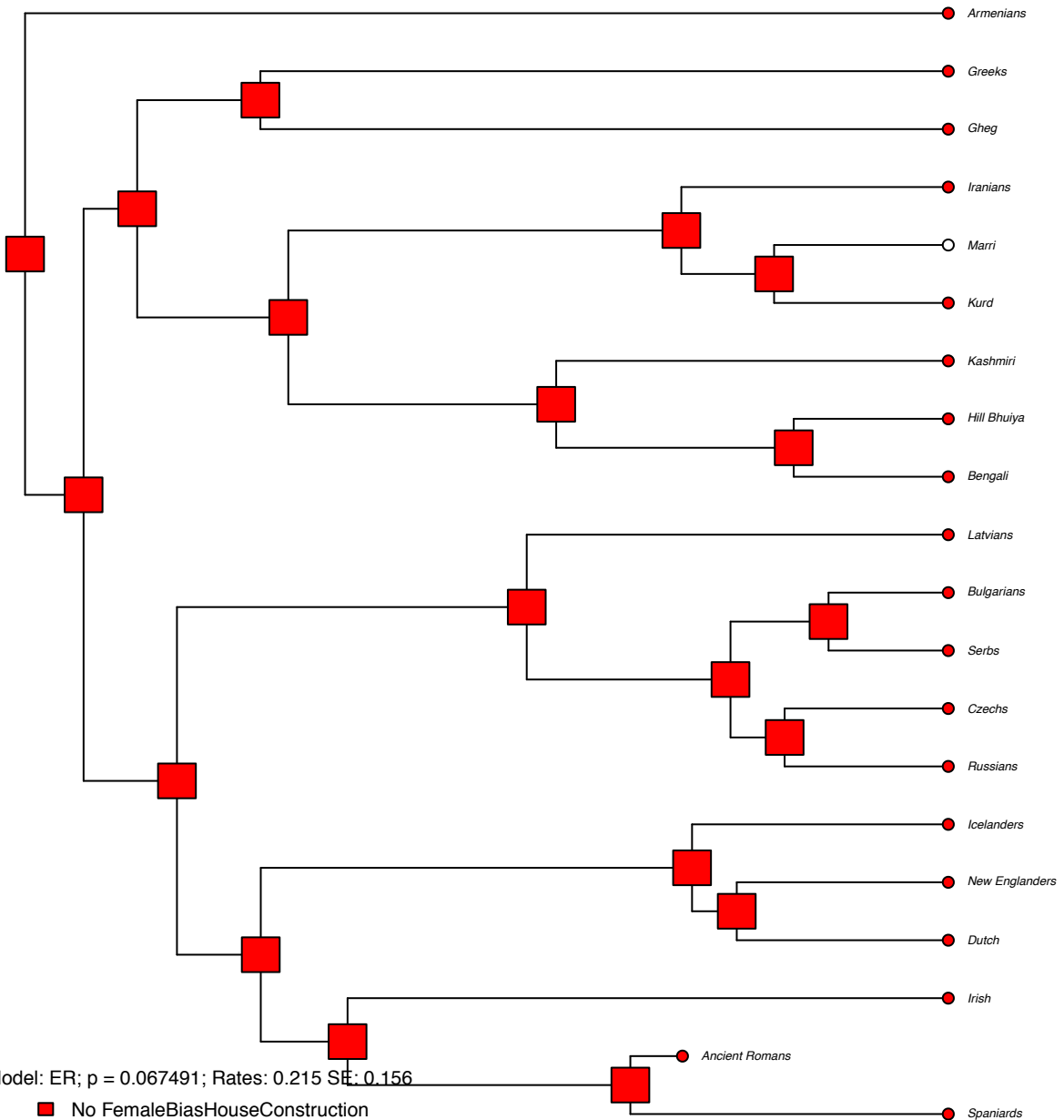

Armenians

Greeks

Ghneg

Iranians

Marri

Kurd

Kashmiri

Hill Bhuiya

Bengali

Latvians

Bulgarians

Serbs

Czechs

Russians

Icelanders

New Englanders

Dutch

Irish

Ancient Romans

Spaniards

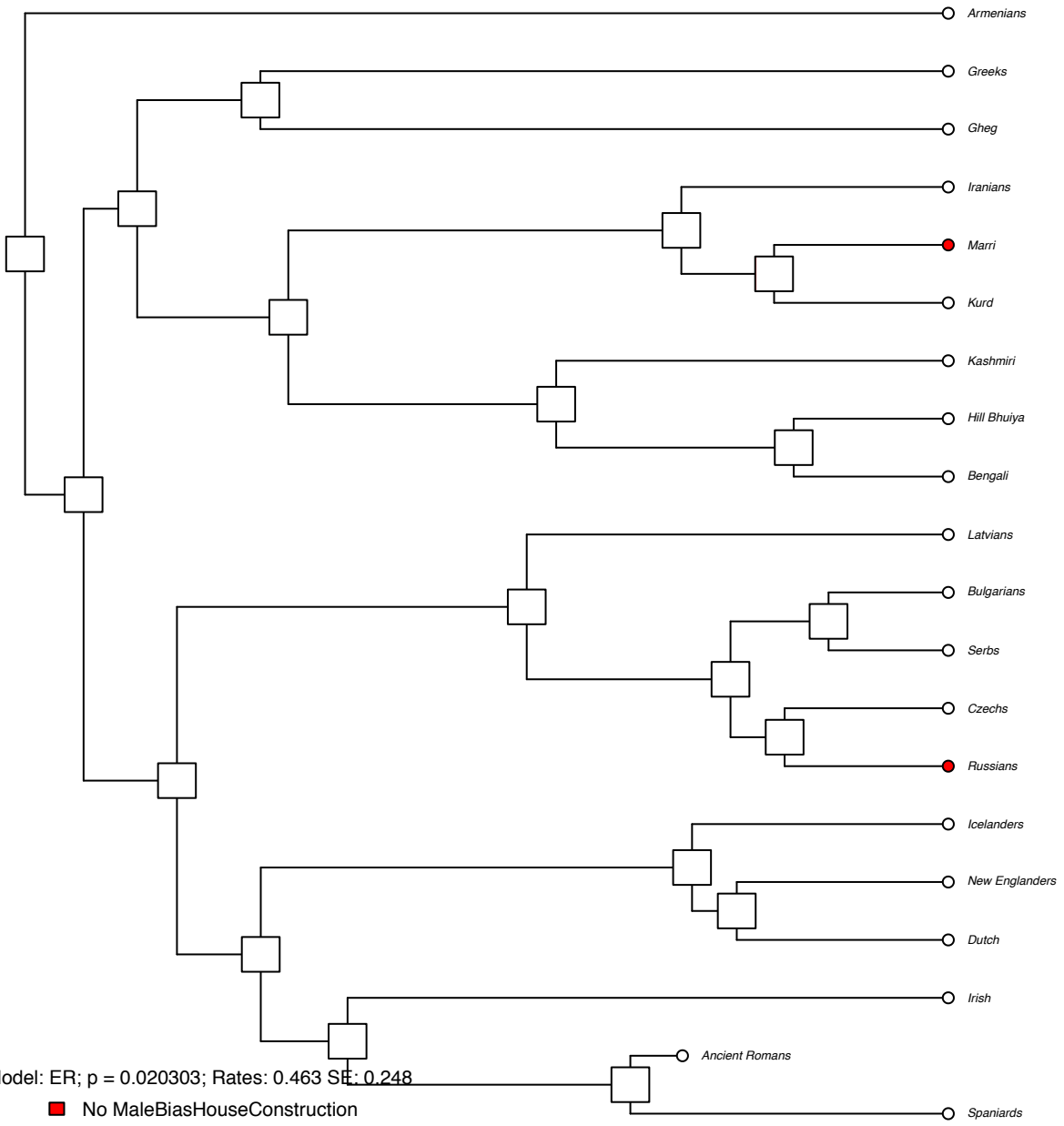

Model: ER; $p = 0.020303$; Rates: 0.463 SE: 0.248

- No MaleBiasHouseConstruction
- MaleBiasHouseConstruction

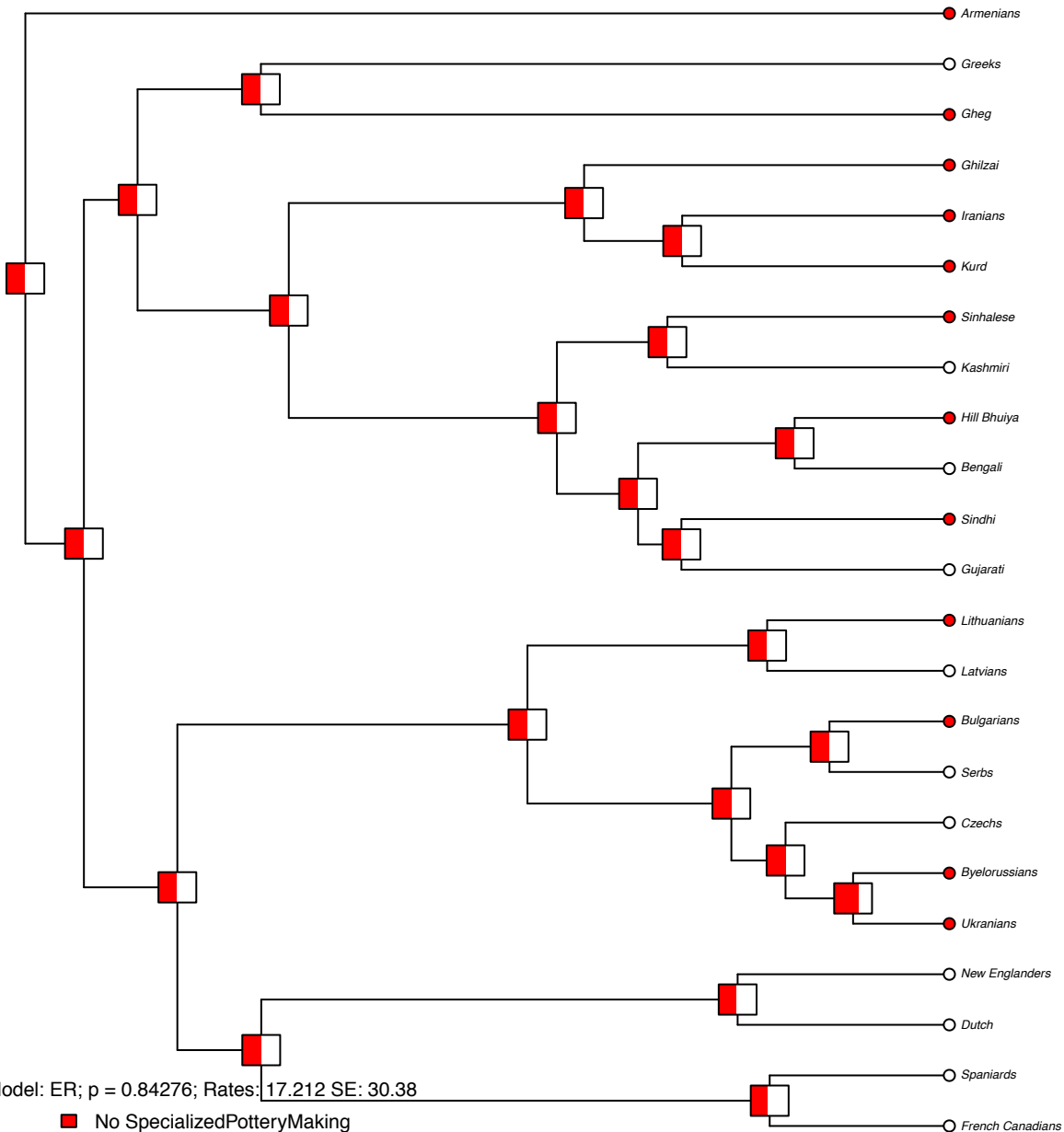

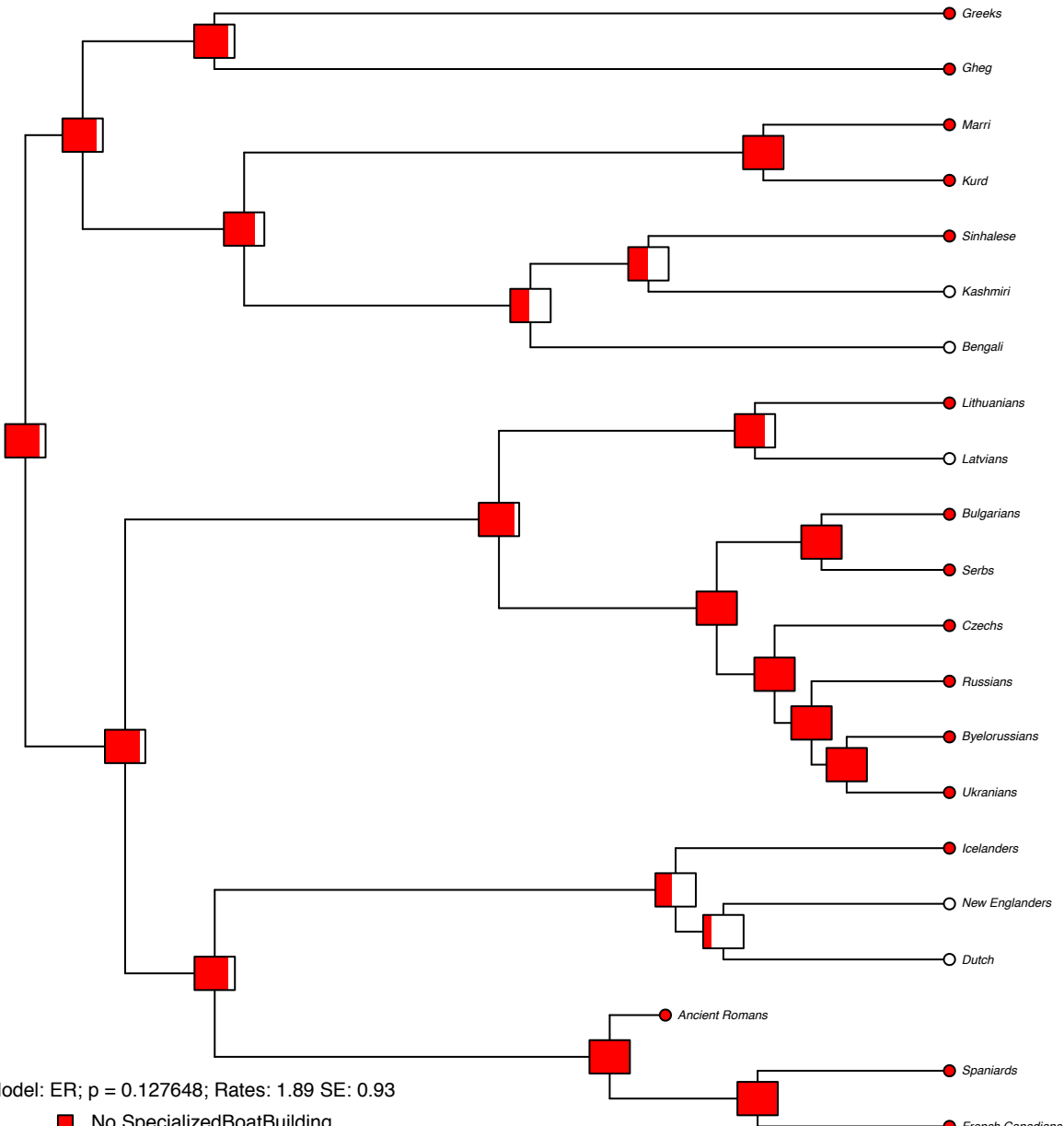

Model: ER; $p = 0.127648$; Rates: 1.89 SE: 0.93

- No SpecializedBoatBuilding
- SpecializedBoatBuilding

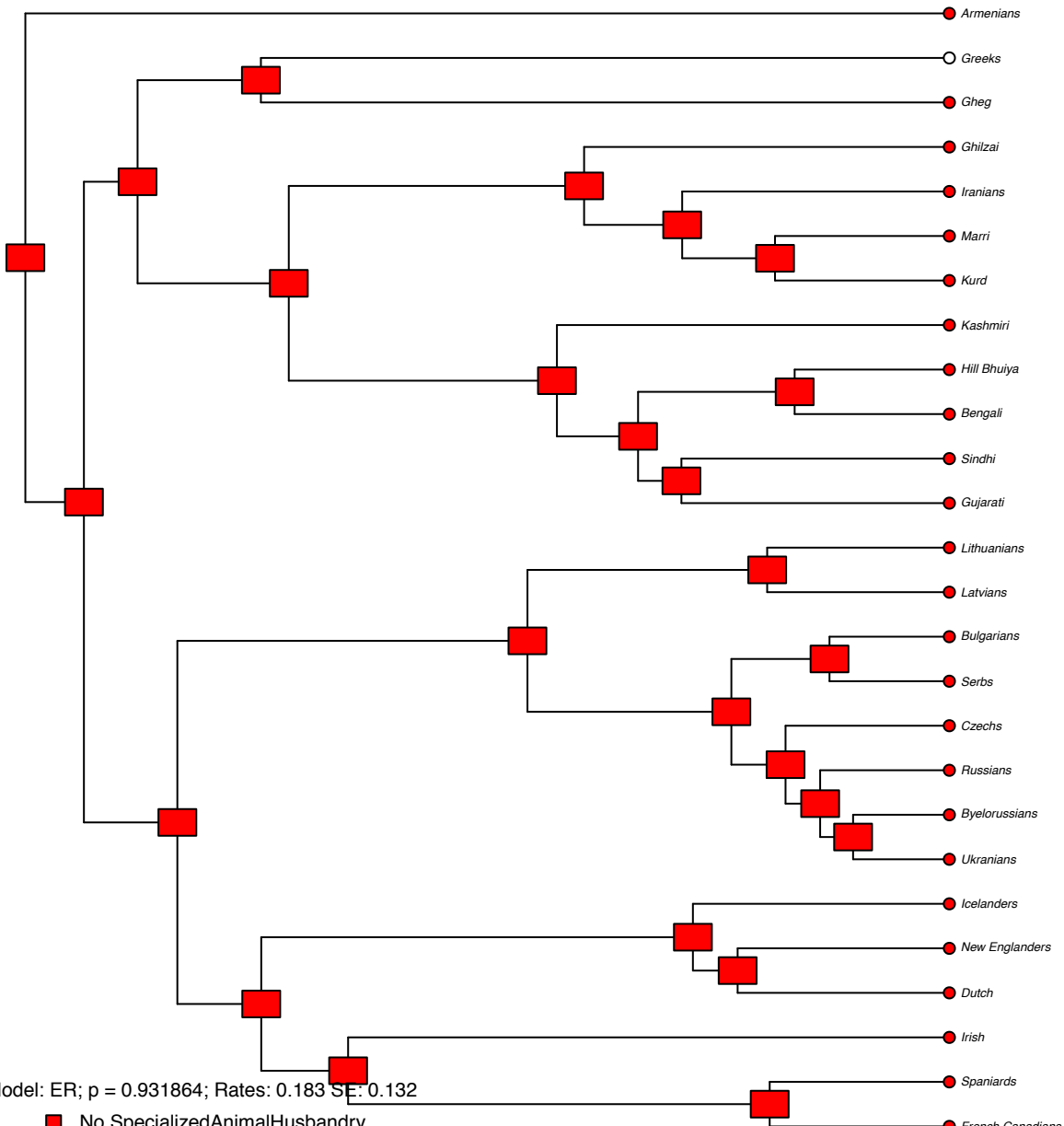

Model: ER; $p = 0.931864$; Rates: 0.183 SE: 0.132

- No SpecializedAnimalHusbandry
- SpecializedAnimalHusbandry

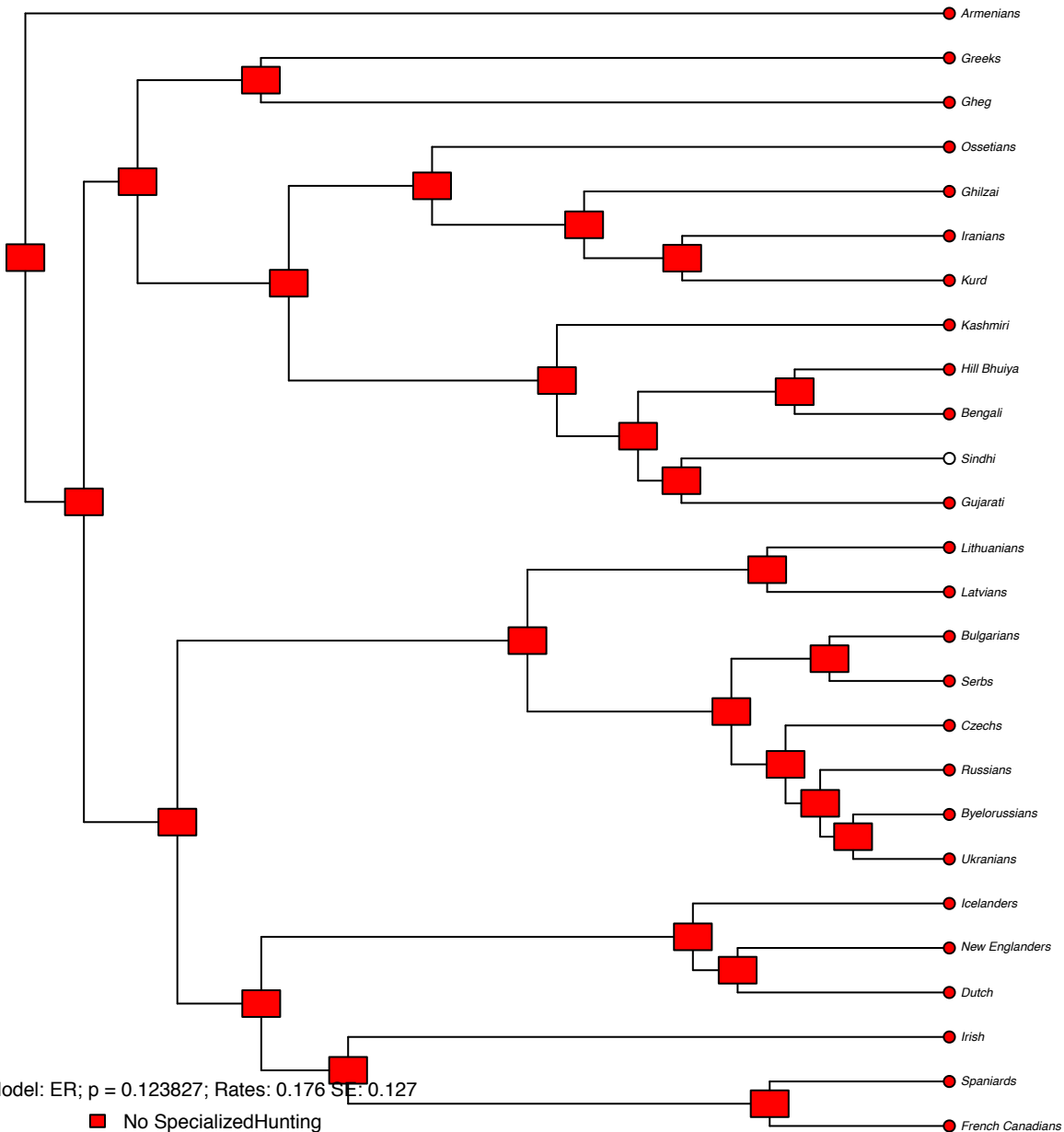

- Armenians
- Greeks
- Ghag
- Ossetians
- Ghilzai
- Iranians
- Kurd
- Kashmiri
- Hill Bhuiya
- Bengali
- Sindhi
- Gujarati
- Lithuanians
- Latvians
- Bulgarians
- Serbs
- Czechs
- Russians
- Byelorussians
- Ukrainians
- Icelanders
- New Englanders
- Dutch
- Irish
- Spaniards
- French Canadians

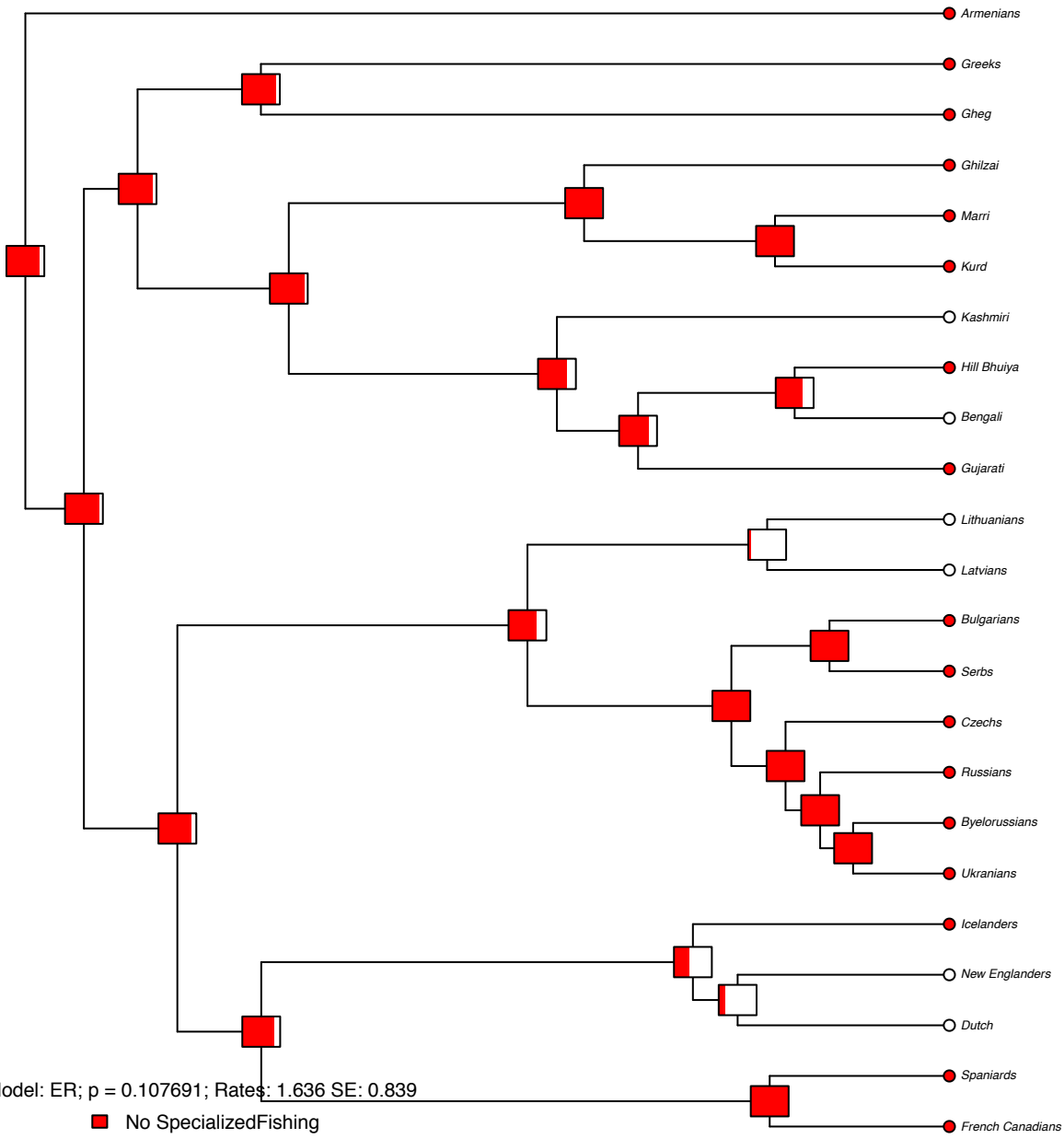

Model: ER; $p = 0.107691$; Rates: 1.636 SE: 0.839

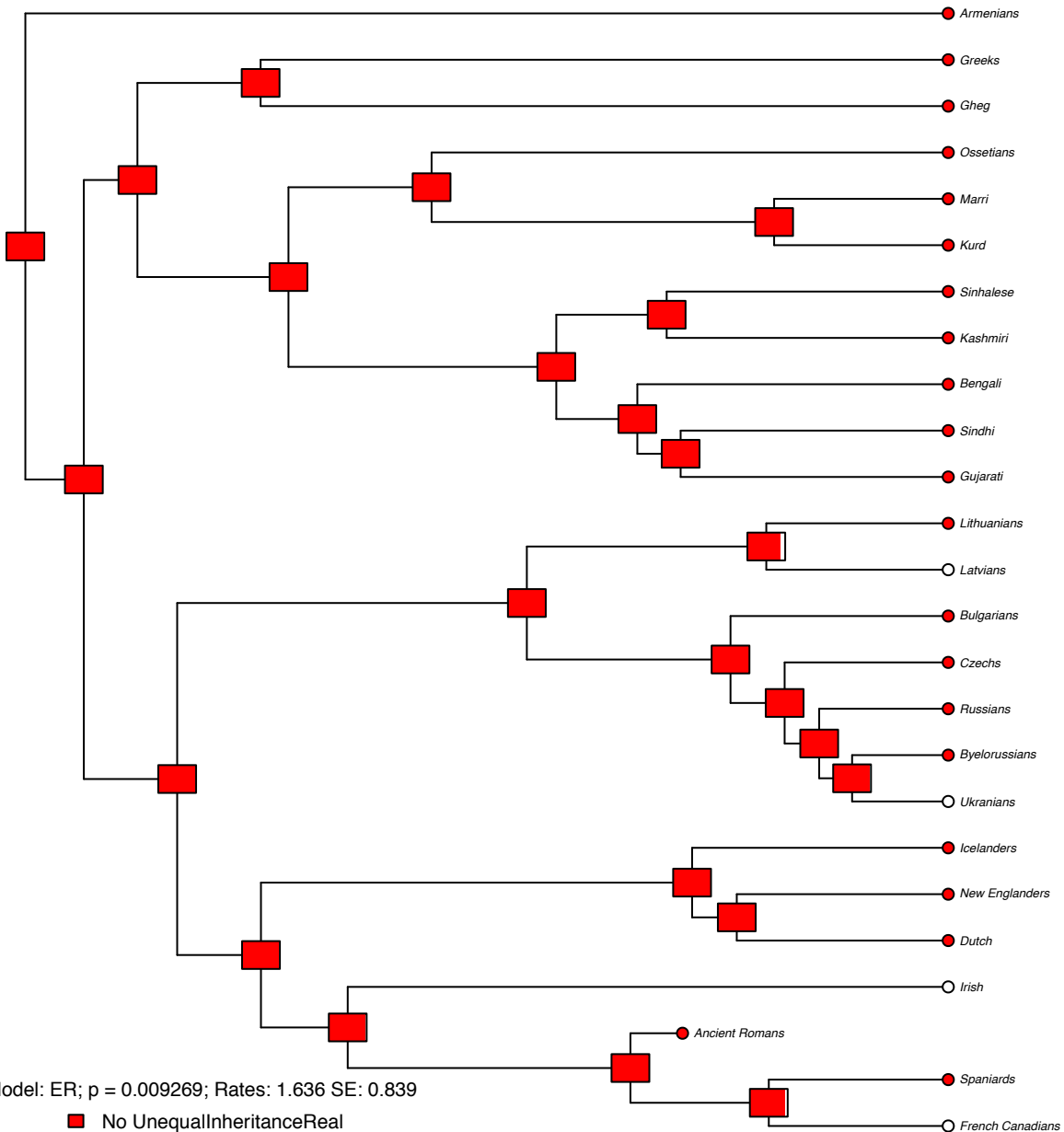

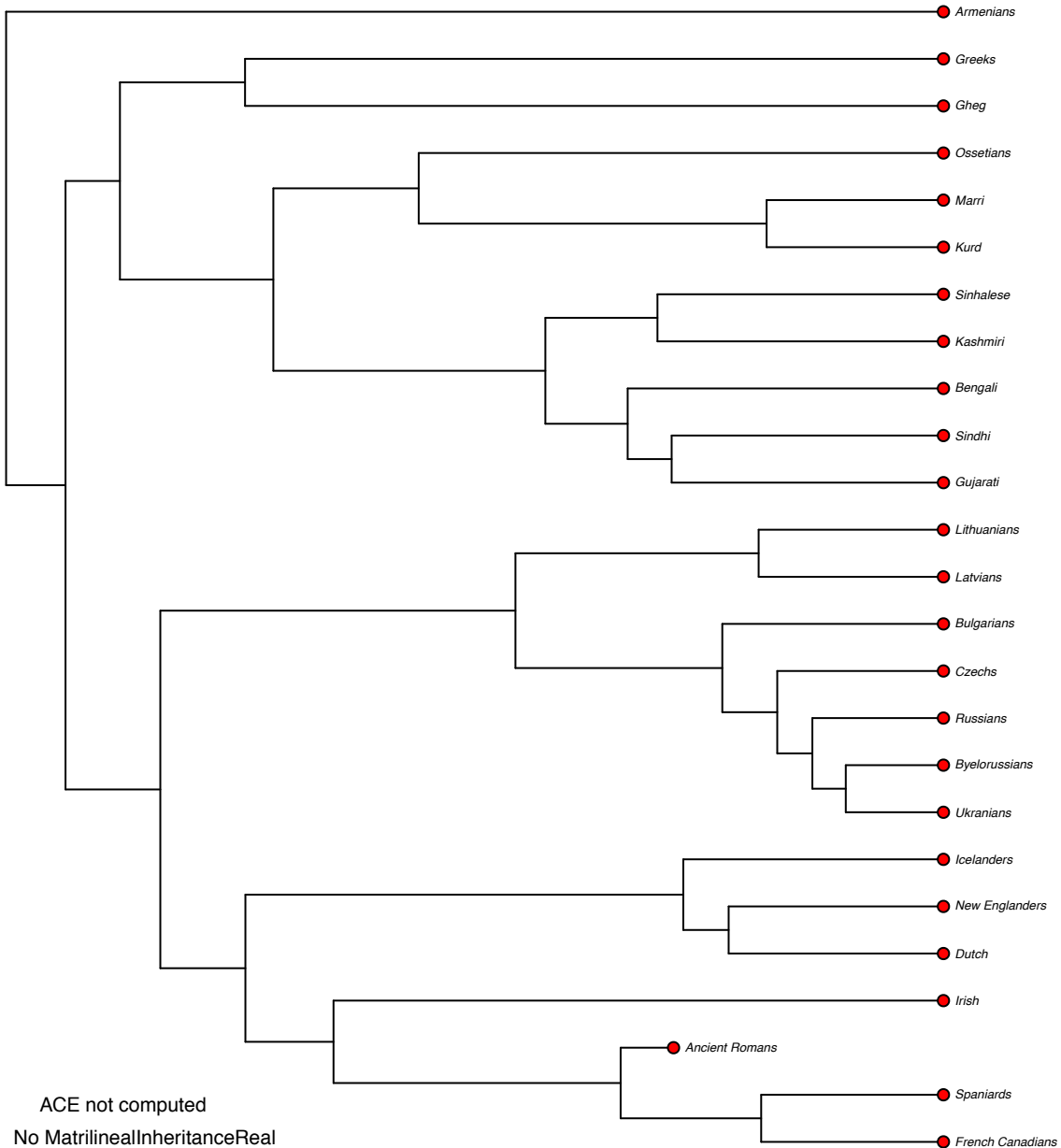

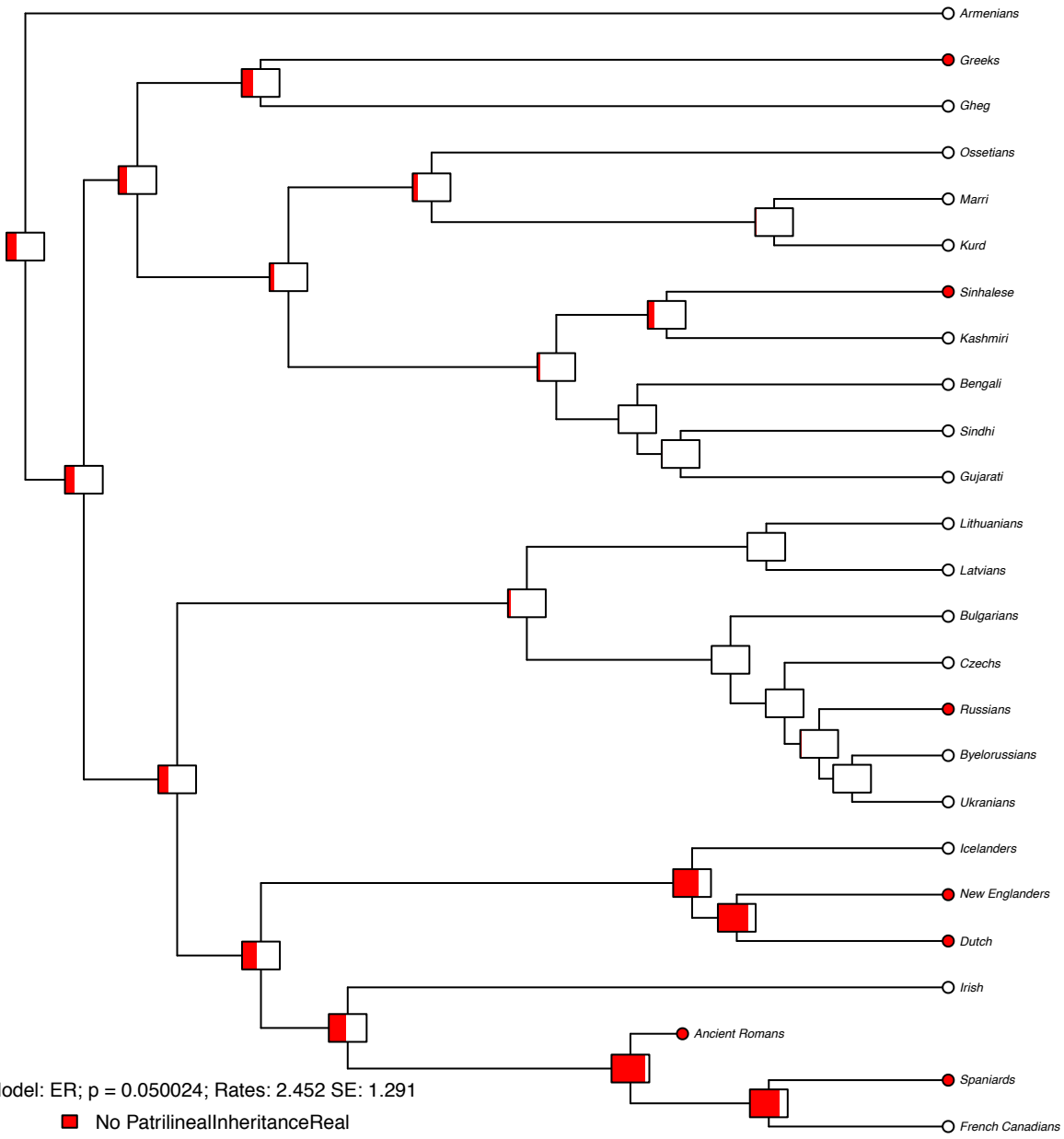

Model: ER; $p = 0.050024$; Rates: 2.452 SE: 1.291

- No PatrilinealInheritanceReal
- PatrilinealInheritanceReal

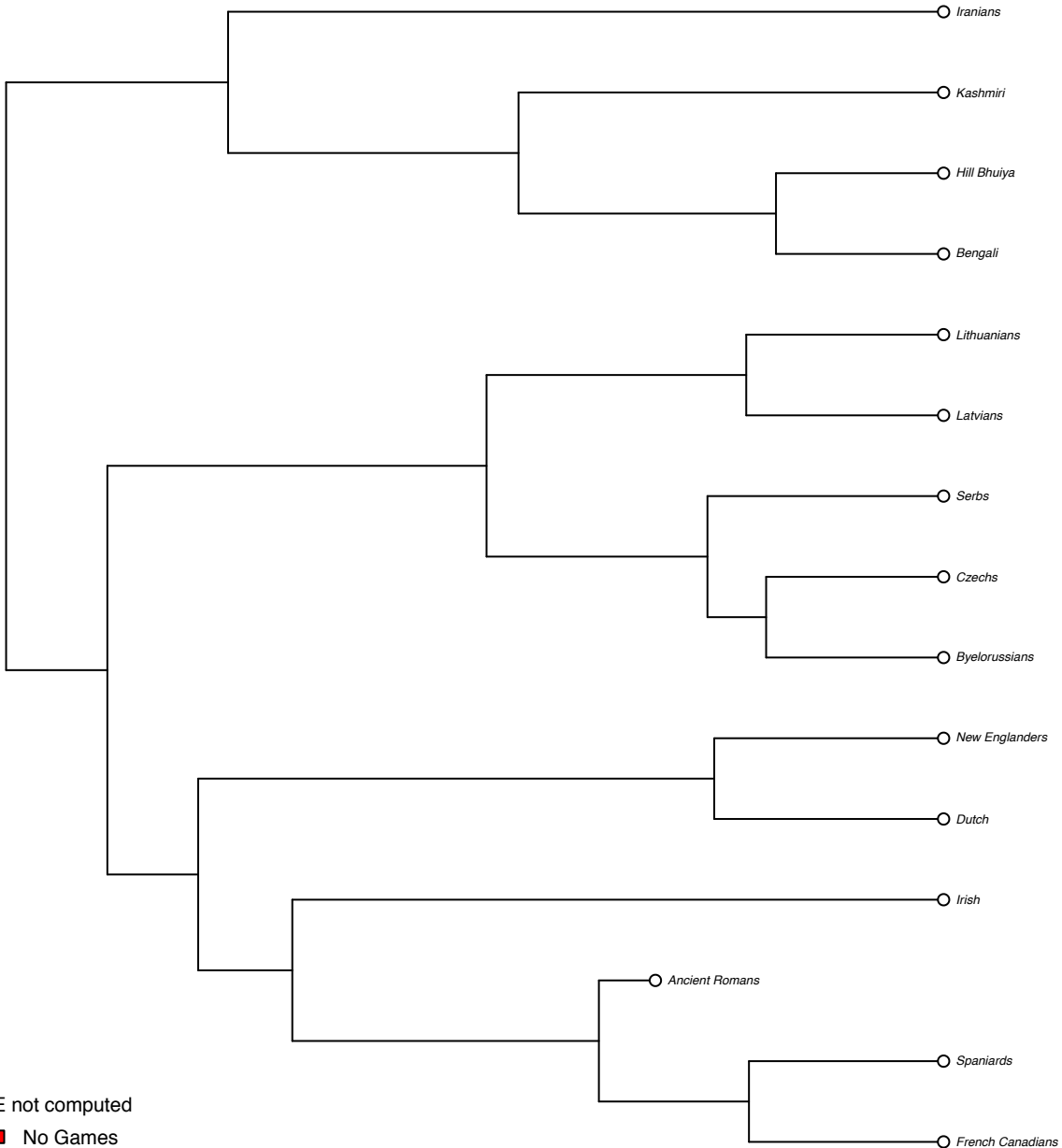

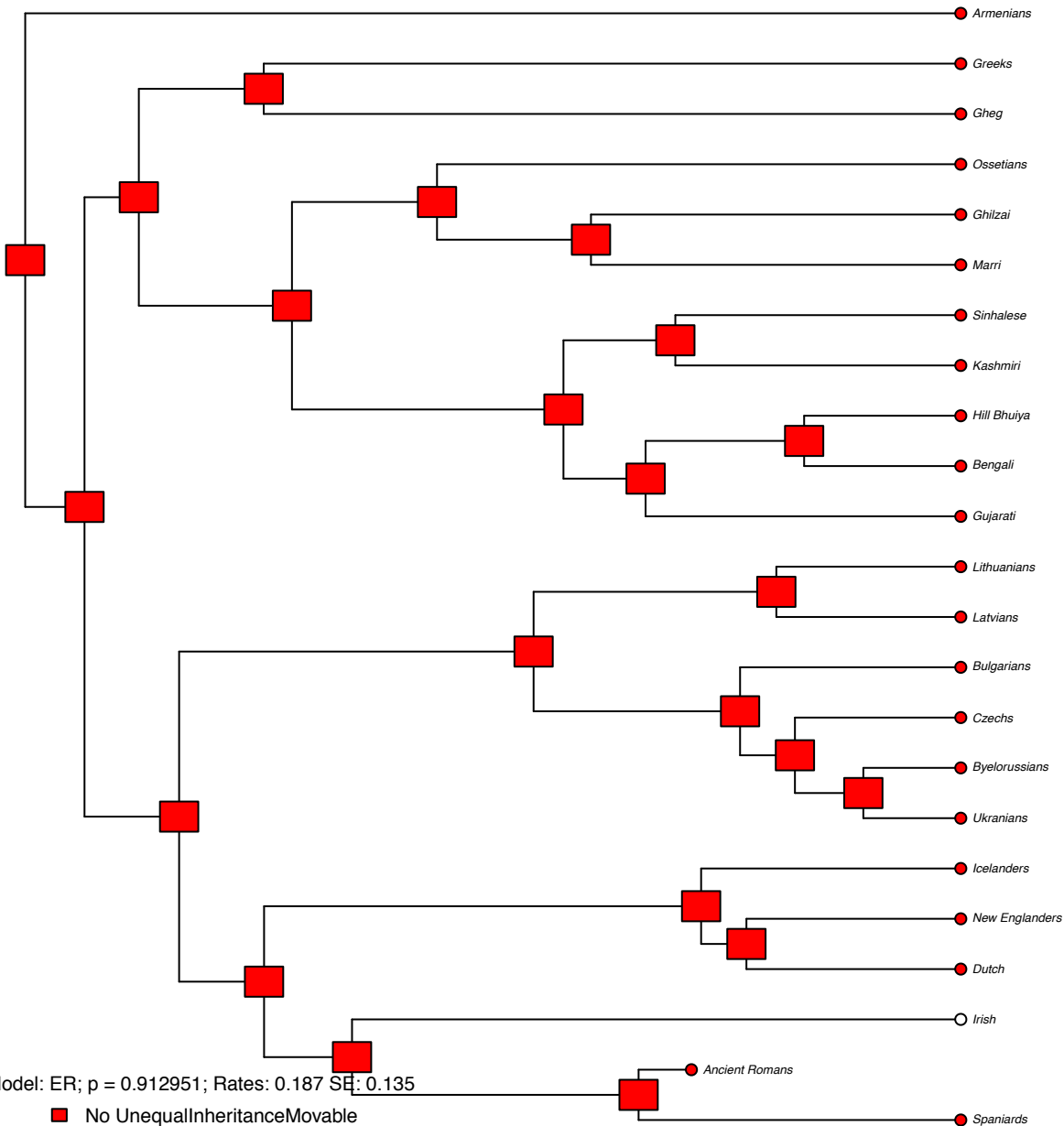

- Armenians
- Greeks
- Ghag
- Ossetians
- Ghilzai
- Marri
- Sinhalese
- Kashmiri
- Hill Bhuiya
- Bengali
- Gujarati
- Lithuanians
- Latvians
- Bulgarians
- Czechs
- Byelorussians
- Ukranians
- Icelanders
- New Englanders
- Dutch
- Irish
- Ancient Romans
- Spaniards

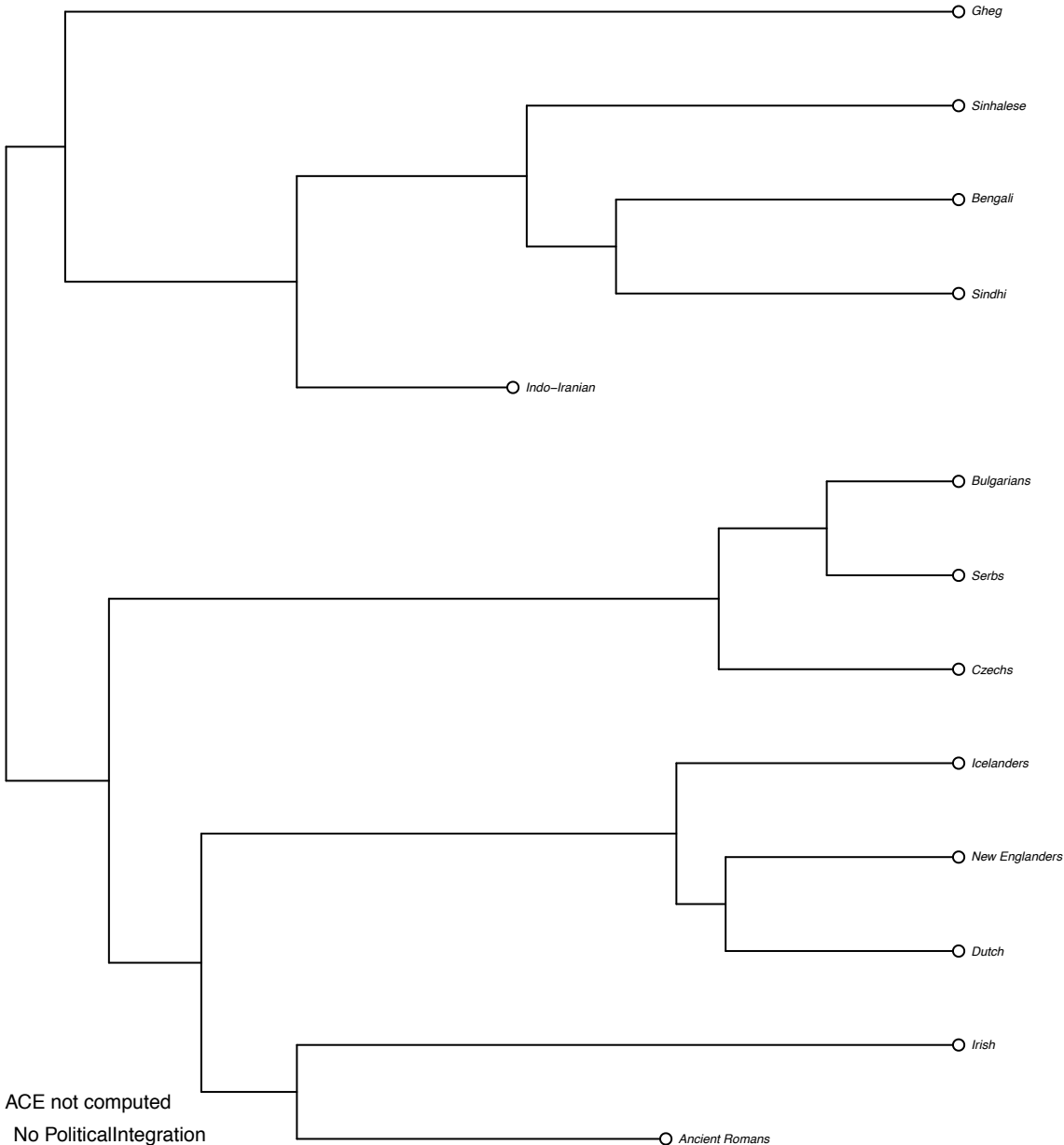

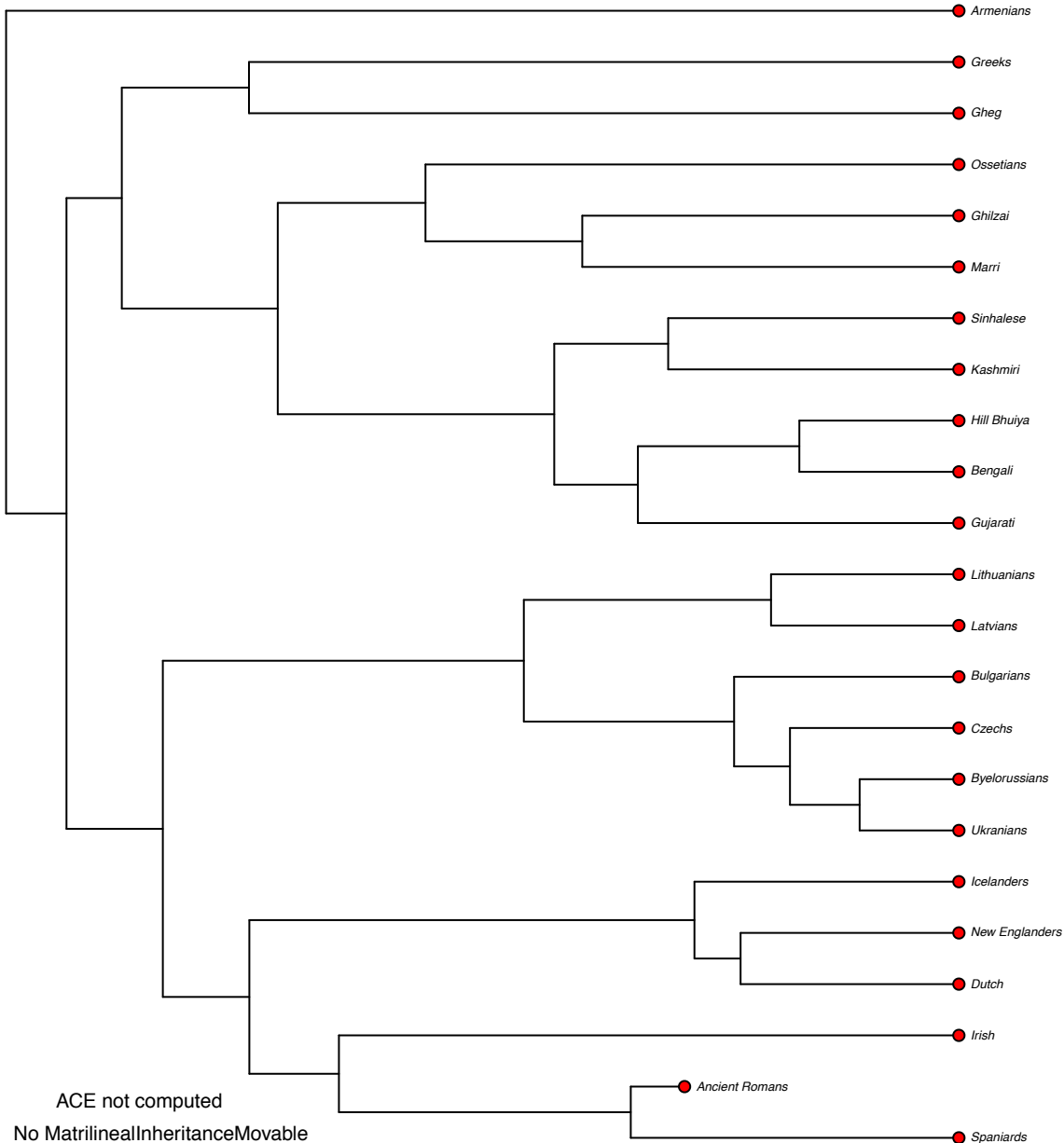

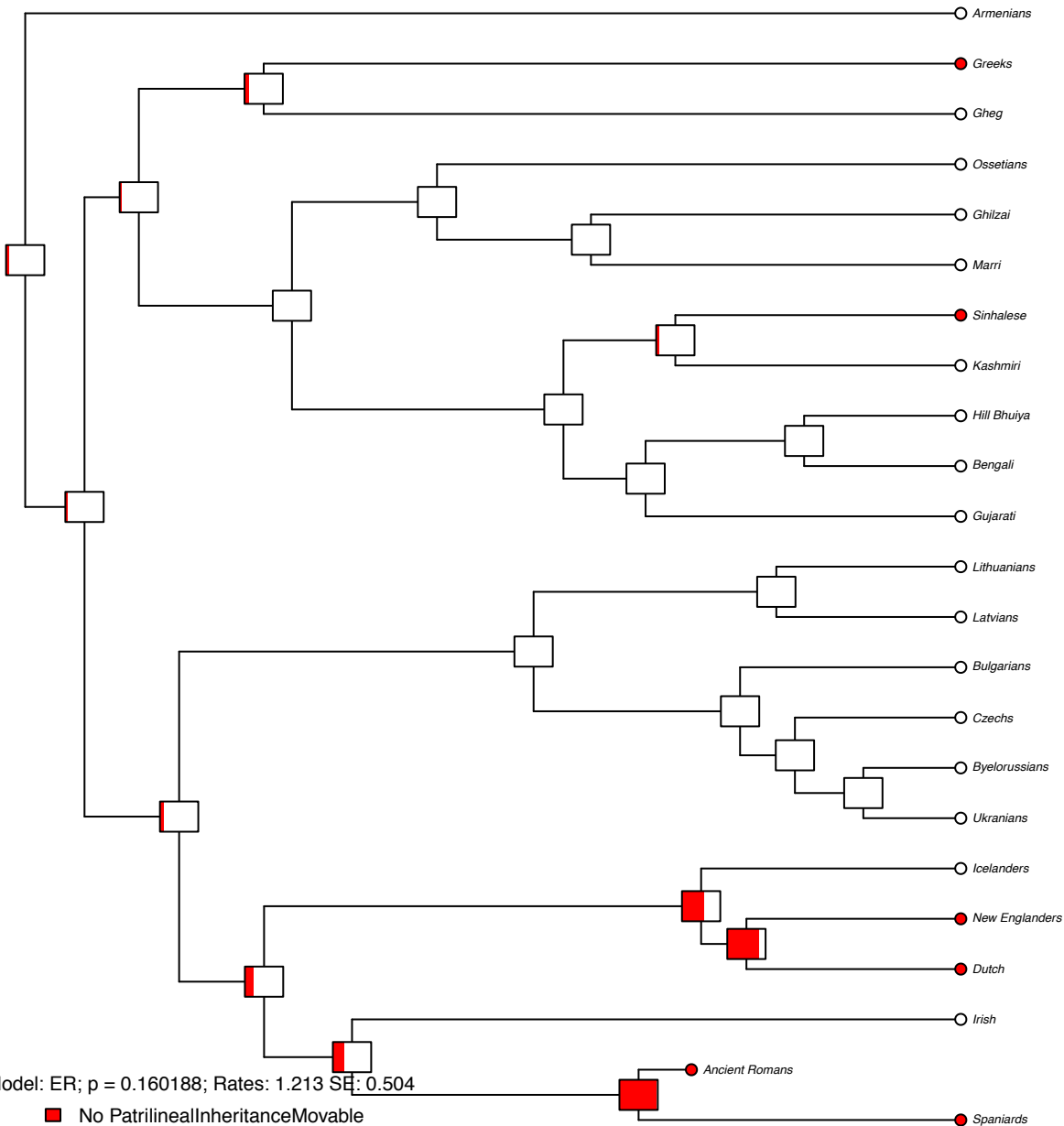

Armenians
 Greeks
 Ghag
 Ossetians
 Ghilzai
 Marri
 Sinhalese
 Kashmiri
 Hill Bhuiya
 Bengali
 Gujarati
 Lithuanians
 Latvians
 Bulgarians
 Czechs
 Byelorussians
 Ukranians
 Icelanders
 New Englanders
 Dutch
 Irish
 Ancient Romans
 Spaniards

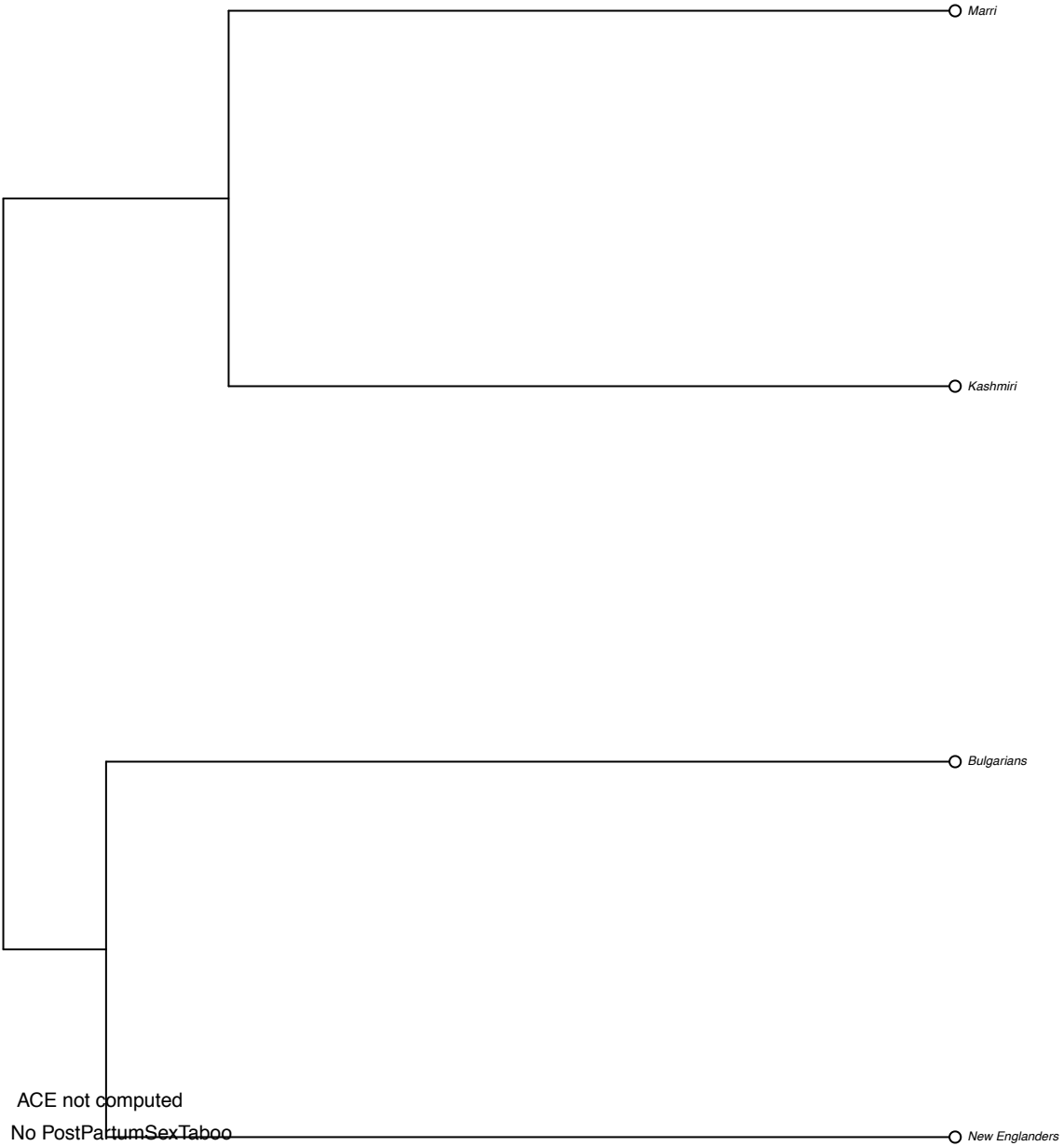

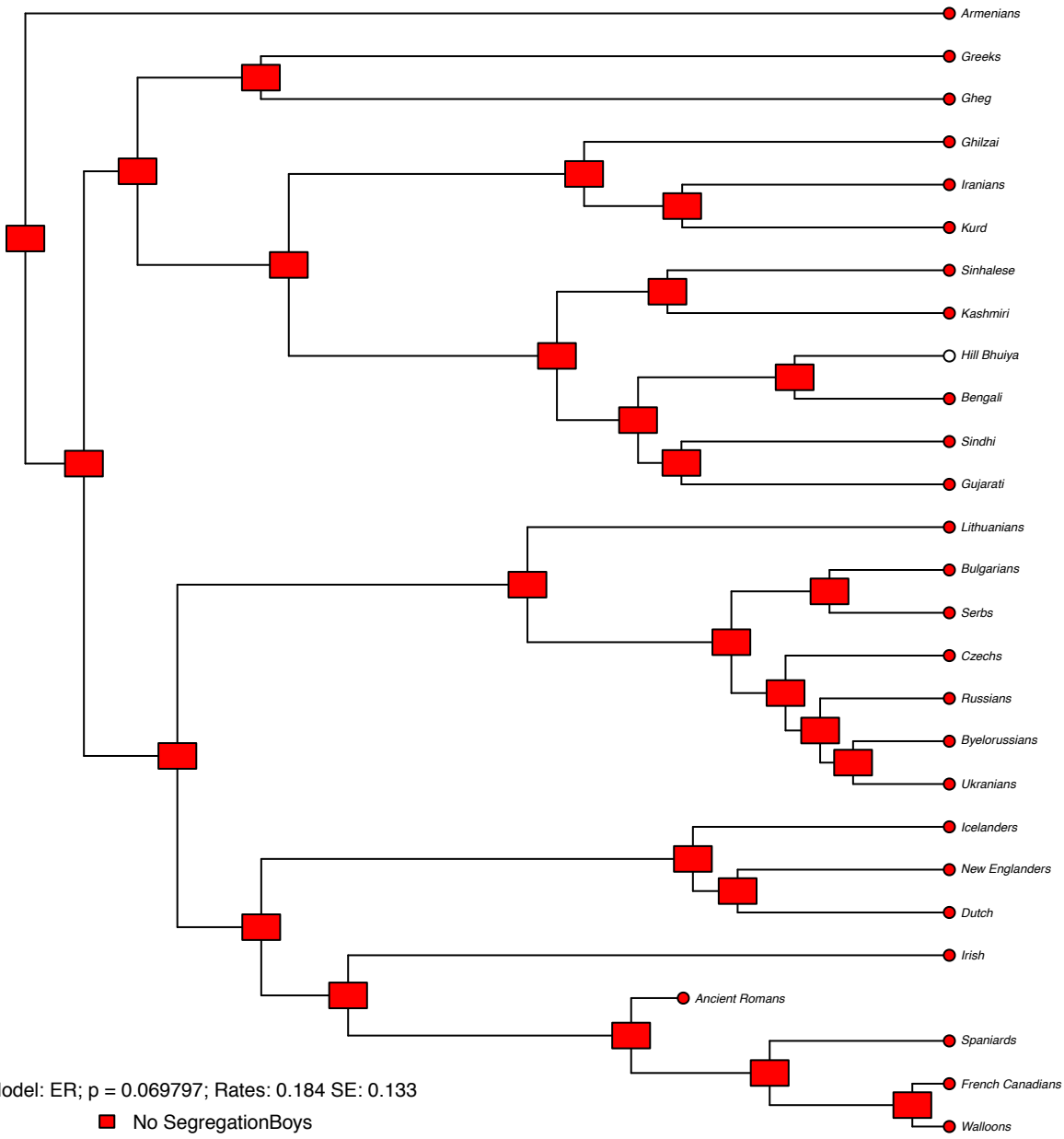

Model: ER; $p = 0.069797$; Rates: 0.184 SE: 0.133

- No SegregationBoys
- SegregationBoys

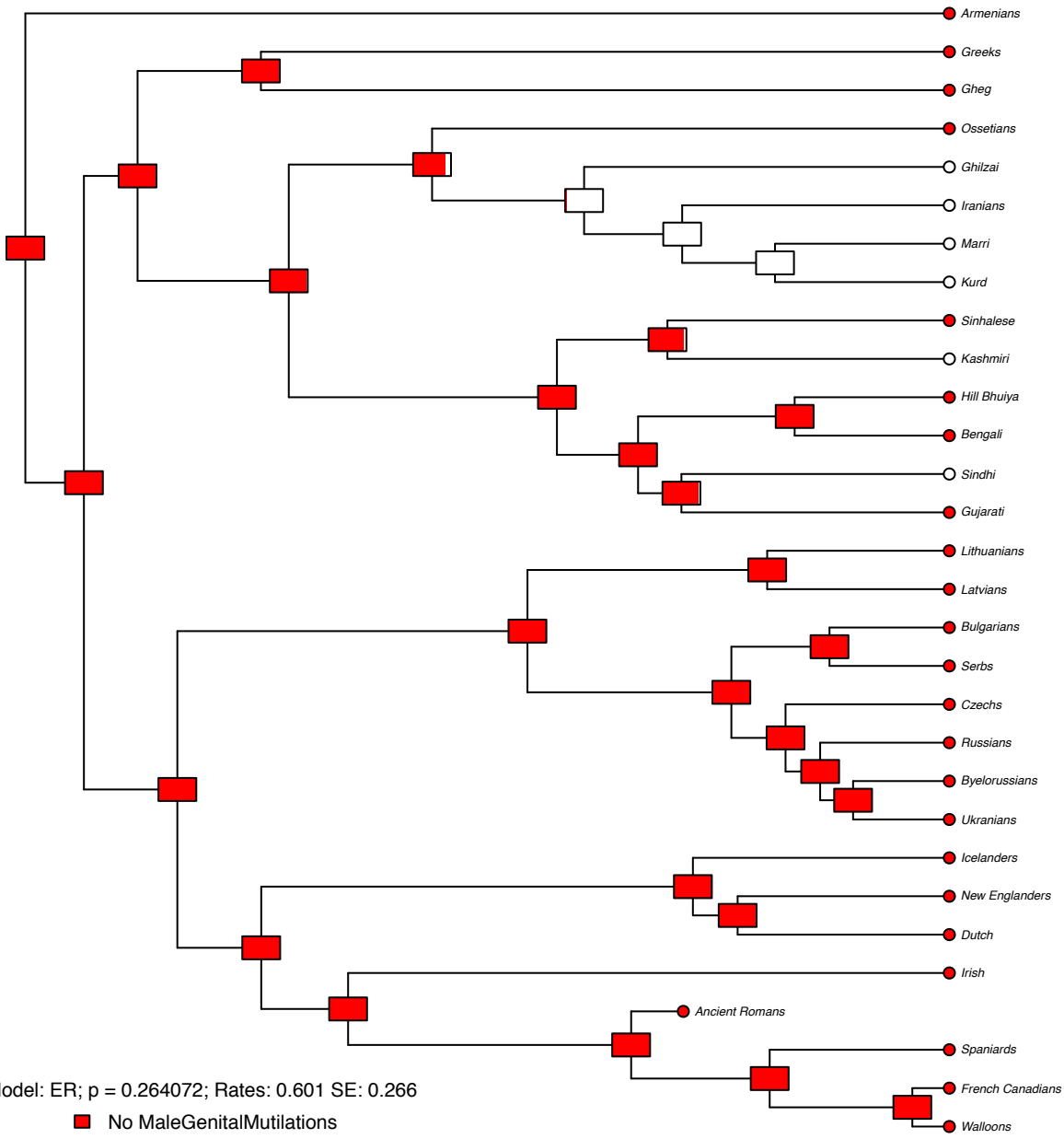

- Armenians
- Greeks
- Ghag
- Ossetians
- Ghilzai
- Iranians
- Marri
- Kurd
- Sinhalese
- Kashmiri
- Hill Bhuiya
- Bengali
- Sindhi
- Gujarati
- Lithuanians
- Latvians
- Bulgarians
- Serbs
- Czechs
- Russians
- Byelorussians
- Ukrainians
- Icelanders
- New Englanders
- Dutch
- Irish
- Ancient Romans
- Spaniards
- French Canadians
- Walloons

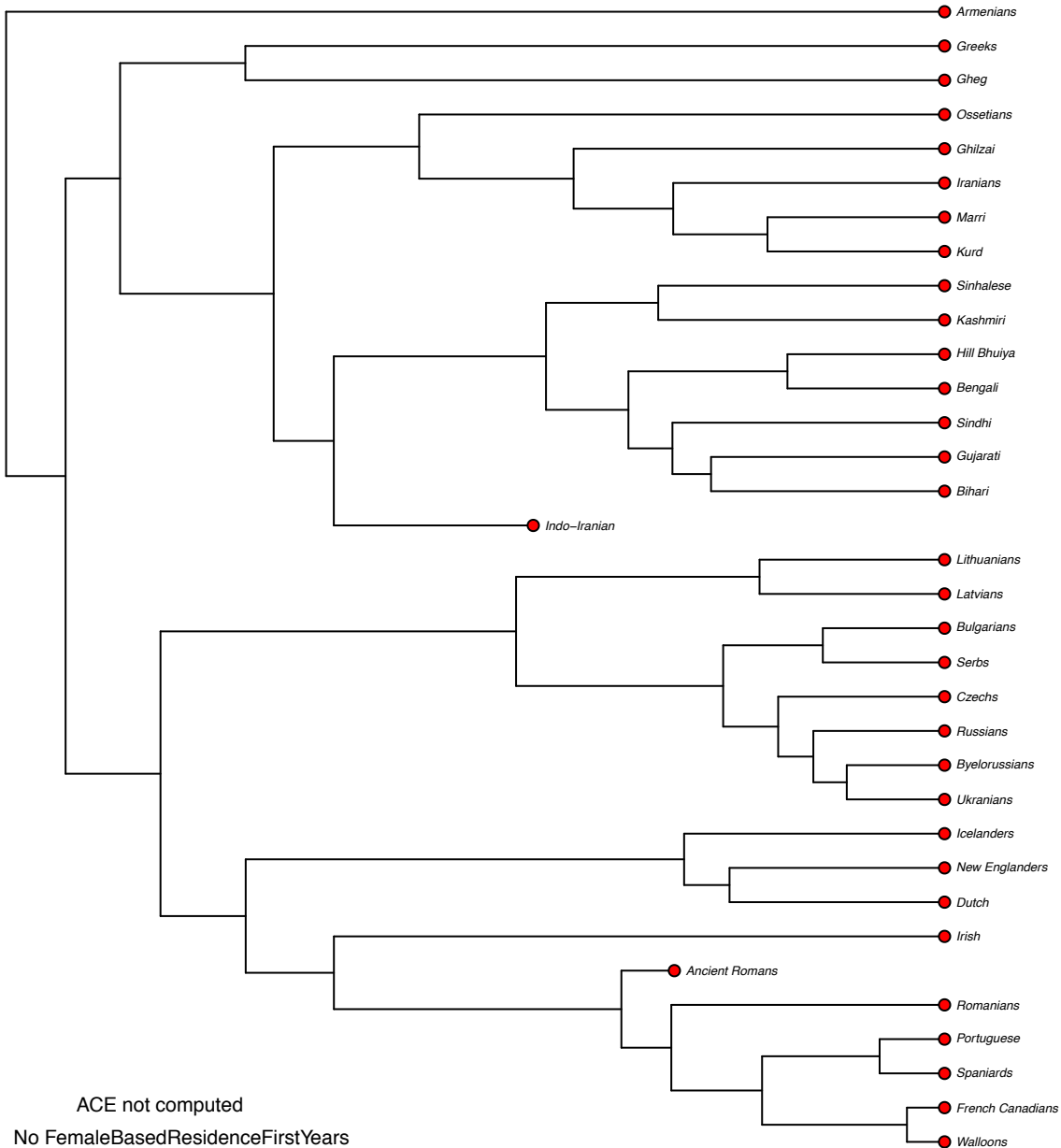

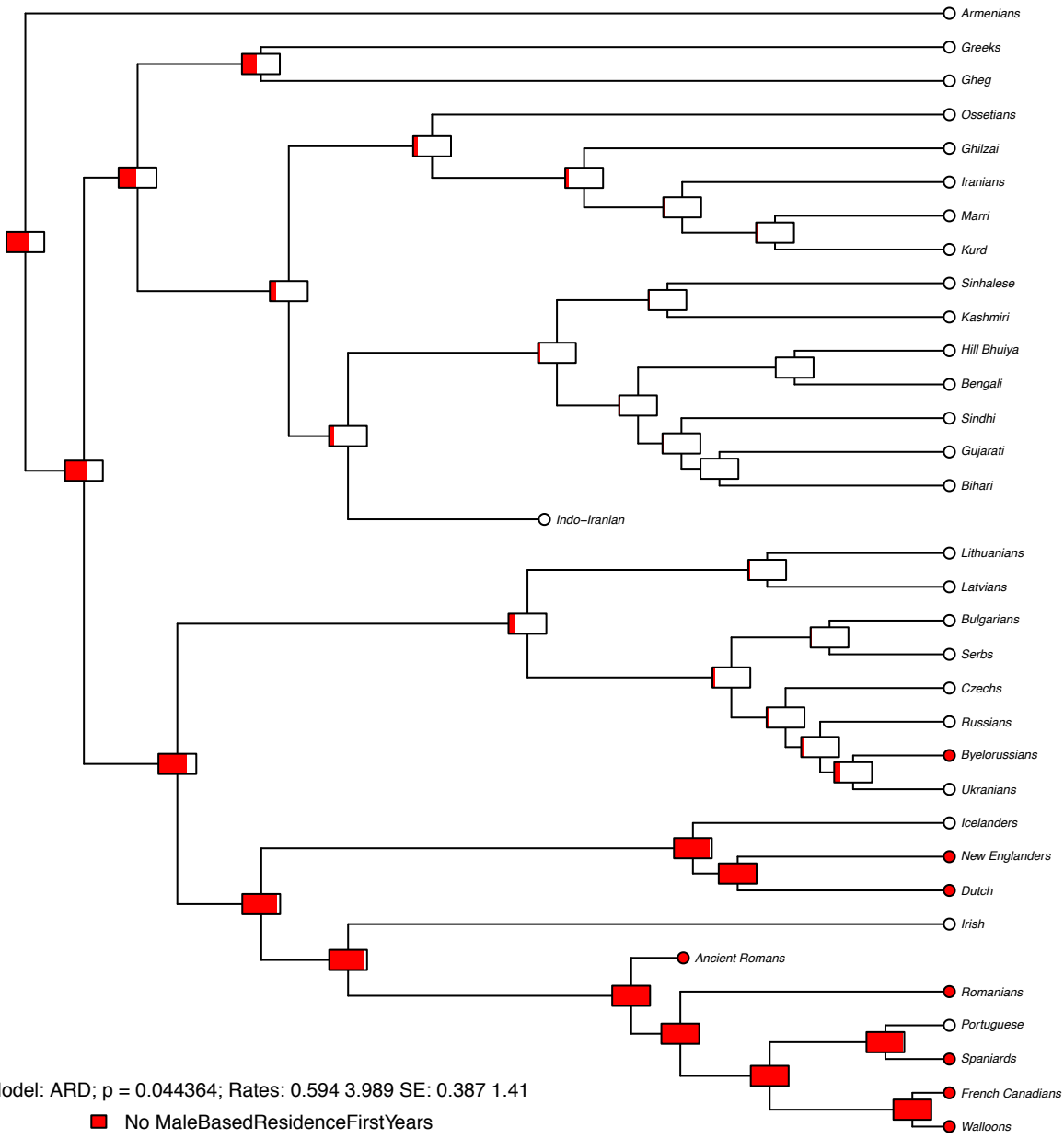

- Armenians
- Greeks
- Gheg
- Ossetians
- Ghilzai
- Iranian
- Marri
- Kurd
- Sinhalese
- Kashmiri
- Hill Bhuiya
- Bengali
- Sindhi
- Gujarati
- Bihari
- Indo-Iranian
- Lithuanians
- Latvians
- Bulgarians
- Serbs
- Czechs
- Russians
- Byelorussians
- Ukrainians
- Icelanders
- New Englanders
- Dutch
- Irish
- Ancient Romans
- Romanians
- Portuguese
- Spaniards
- French Canadians
- Walloons

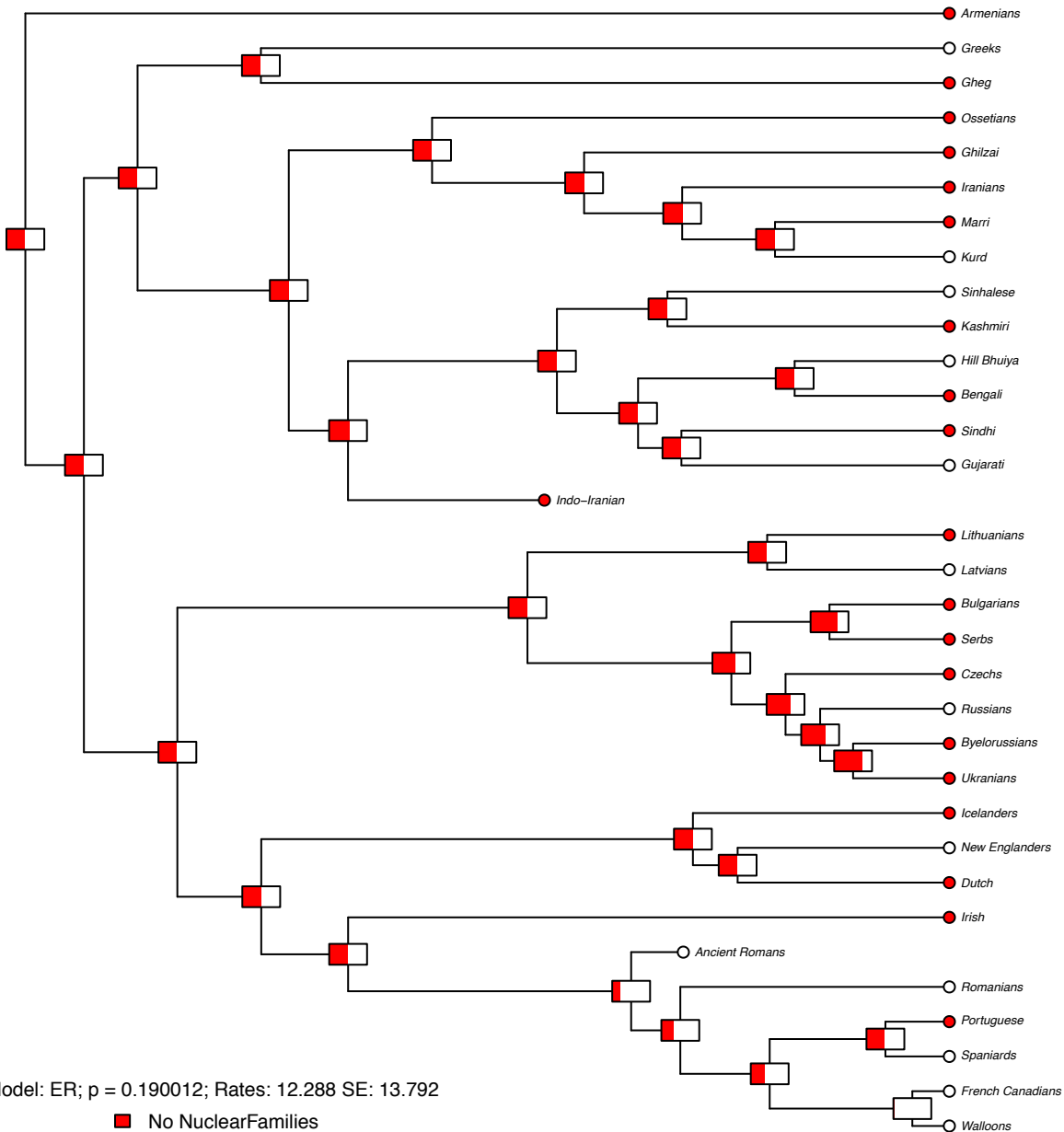

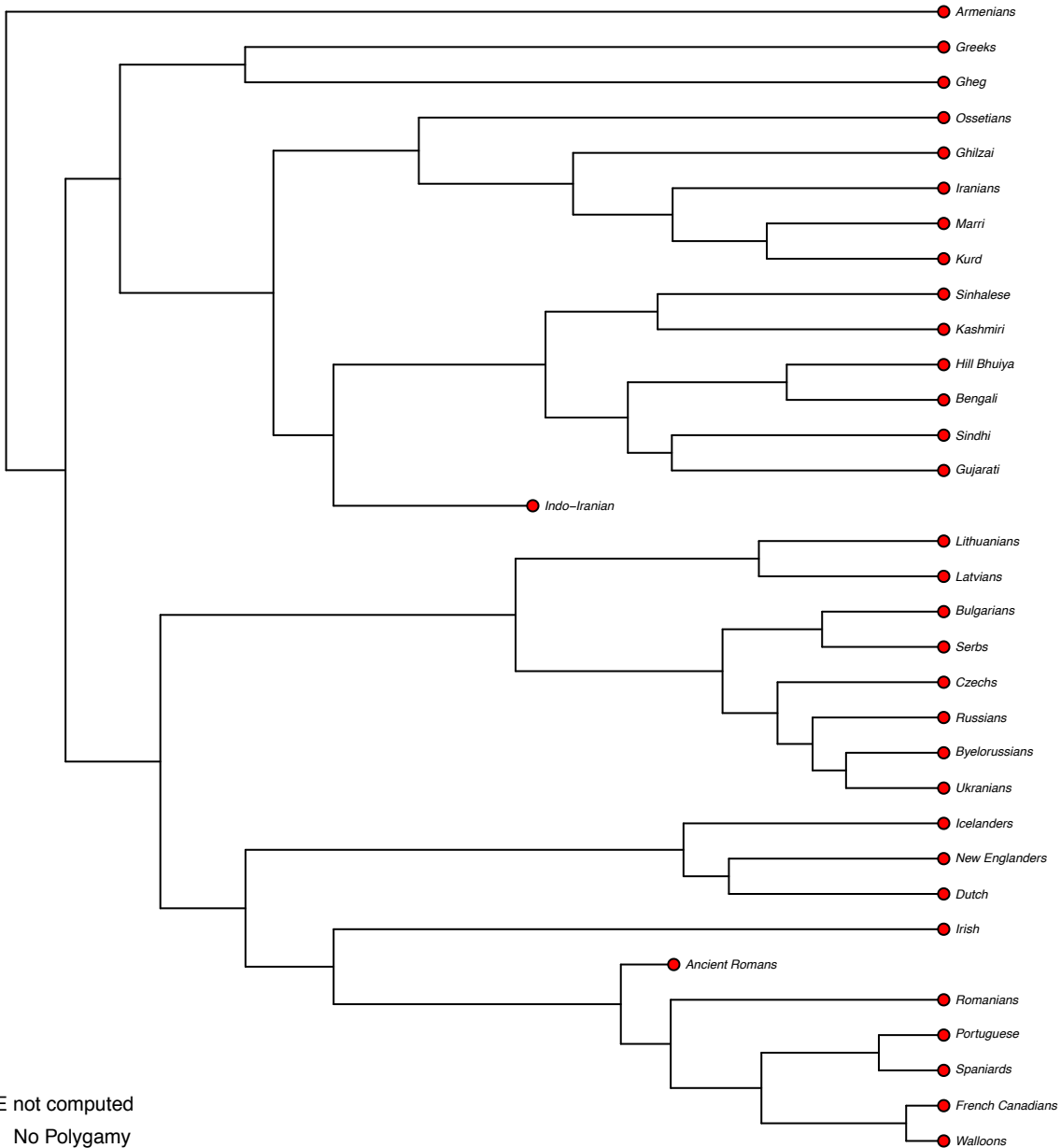

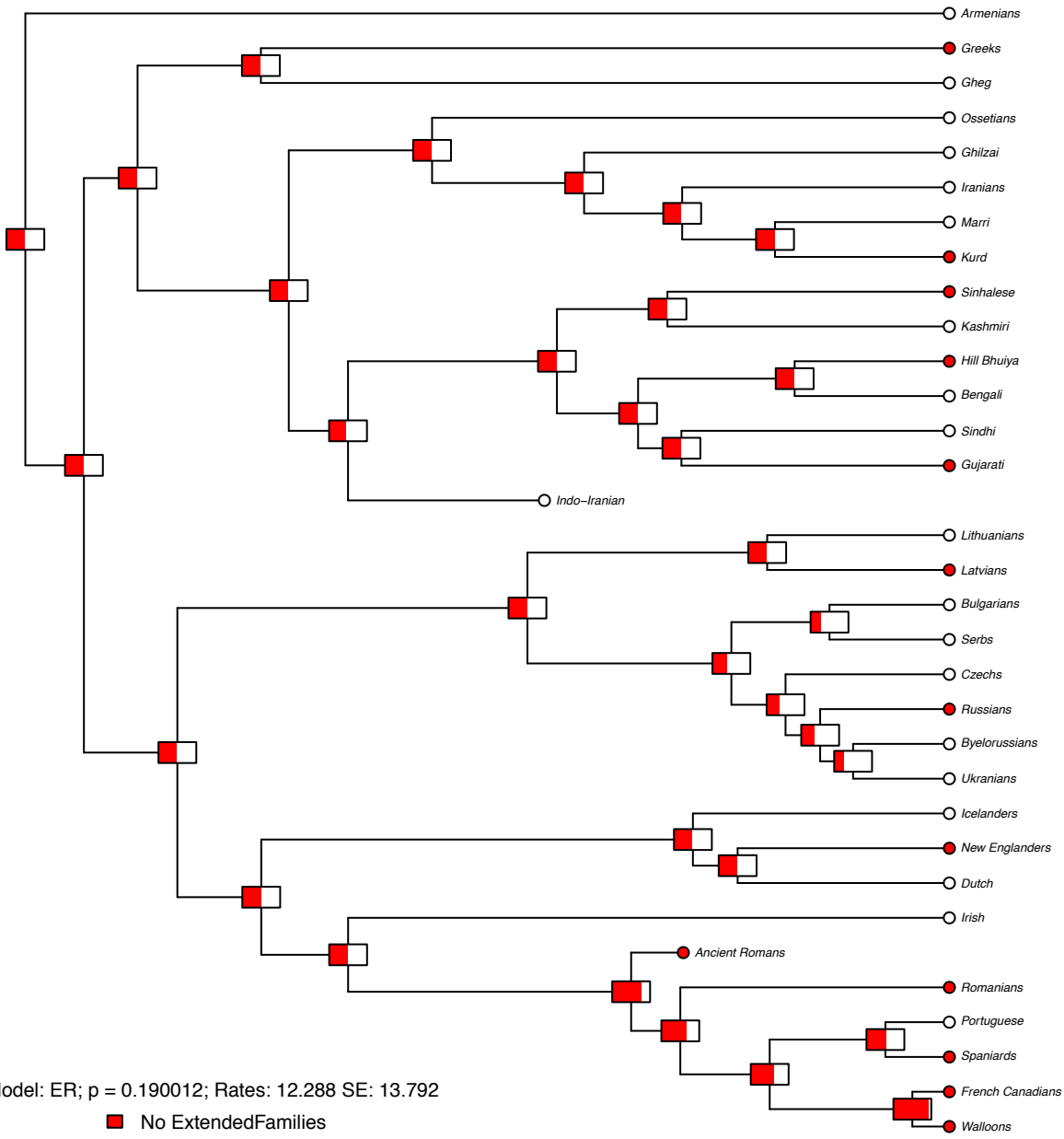

Model: ER; $p = 0.190012$; Rates: 12.288 SE: 13.792

■ No ExtendedFamilies
 ExtendedFamilies

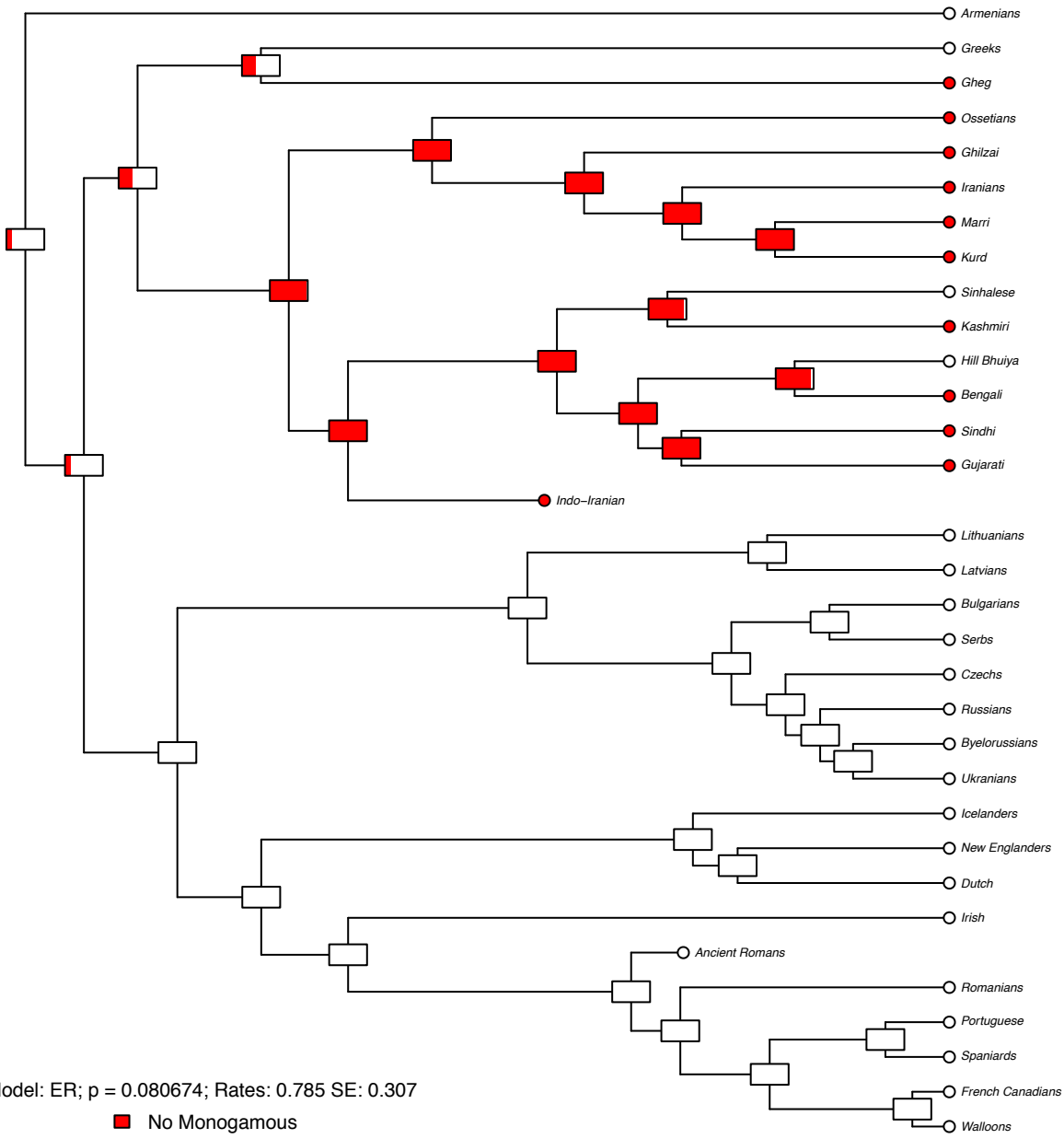

Model: ER; $p = 0.080674$; Rates: 0.785 SE: 0.307

■ No Monogamous
 Monogamous

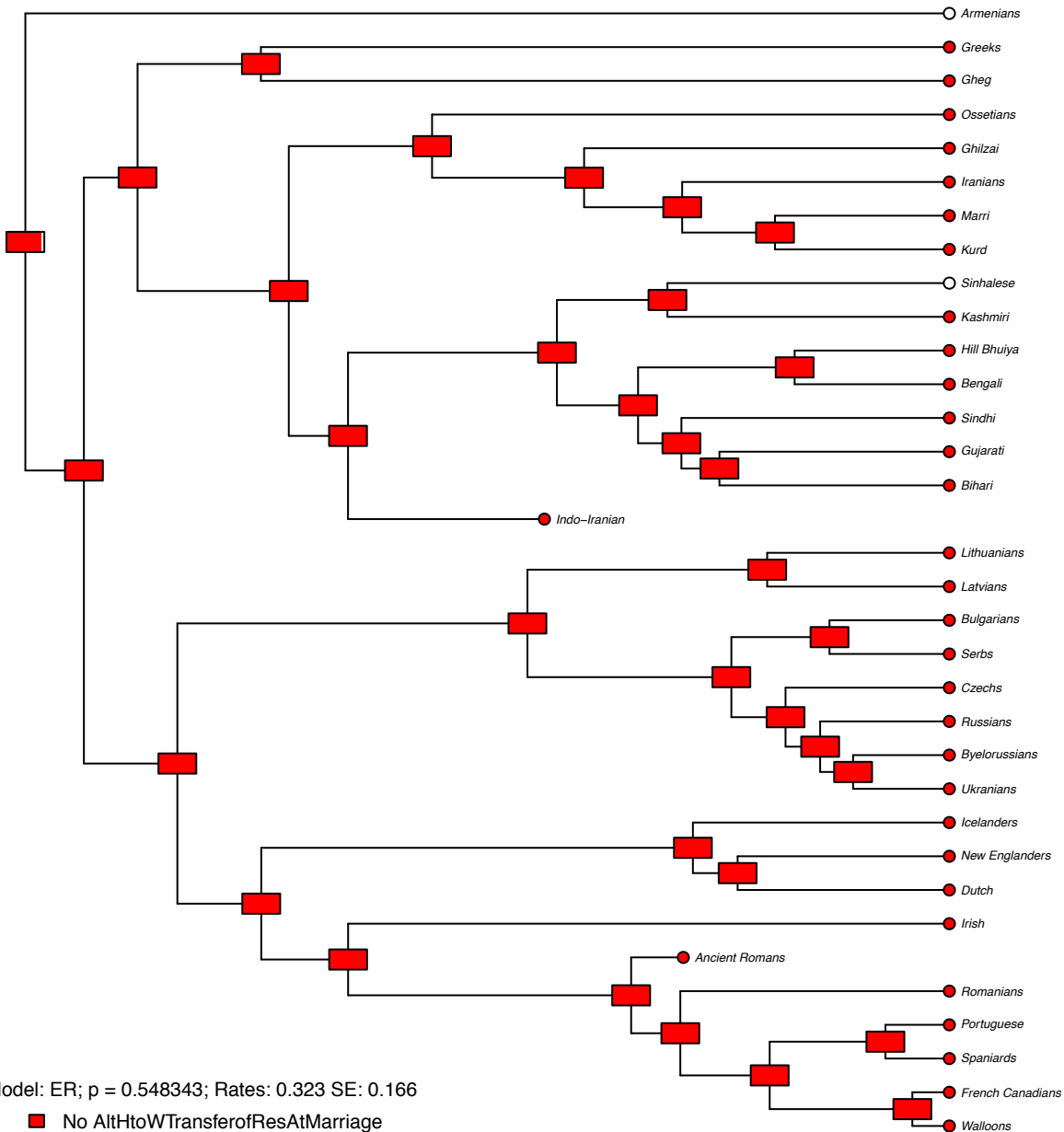

Model: ER; $p = 0.548343$; Rates: 0.323 SE: 0.166

- No AltHtoWTransferofResAtMarriage
- AltHtoWTransferofResAtMarriage



- Armenians
- Greeks
- Gheg
- Ossetians
- Ghilzai
- Iranians
- Marri
- Kurd
- Sinhalese
- Kashmiri
- Hill Bhuiya
- Bengali
- Sindhi
- Gujarati
- Bihari
- Indo-Iranian
- Lithuanians
- Latvians
- Bulgarians
- Serbs
- Czechs
- Russians
- Byelorussians
- Ukrainians
- Icelanders
- New Englanders
- Dutch
- Irish
- Ancient Romans
- Romanians
- Portuguese
- Spaniards
- French Canadians
- Walloons

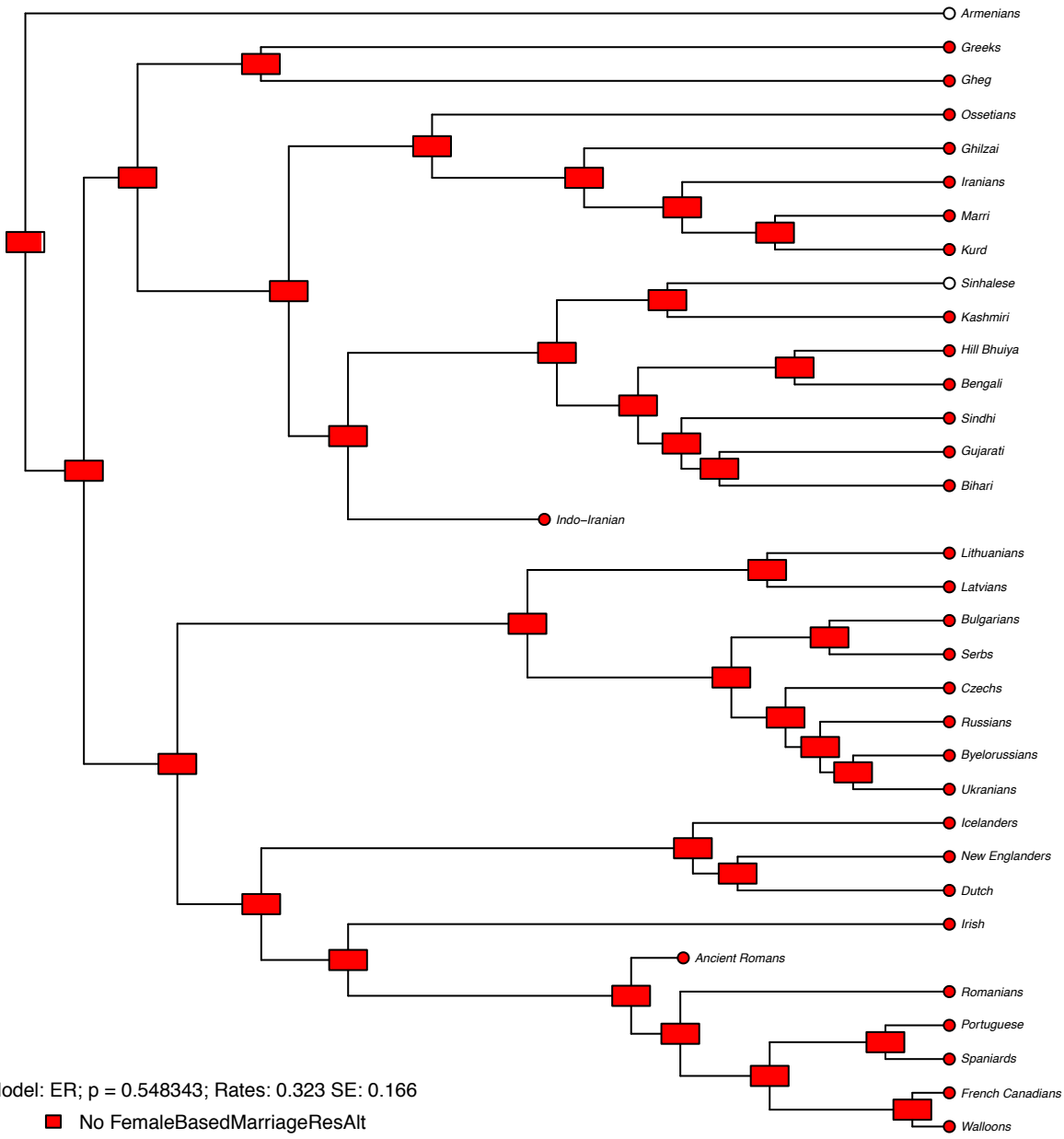

Model: ER; $p = 0.548343$; Rates: 0.323 SE: 0.166

- No FemaleBasedMarriageResAlt
- FemaleBasedMarriageResAlt

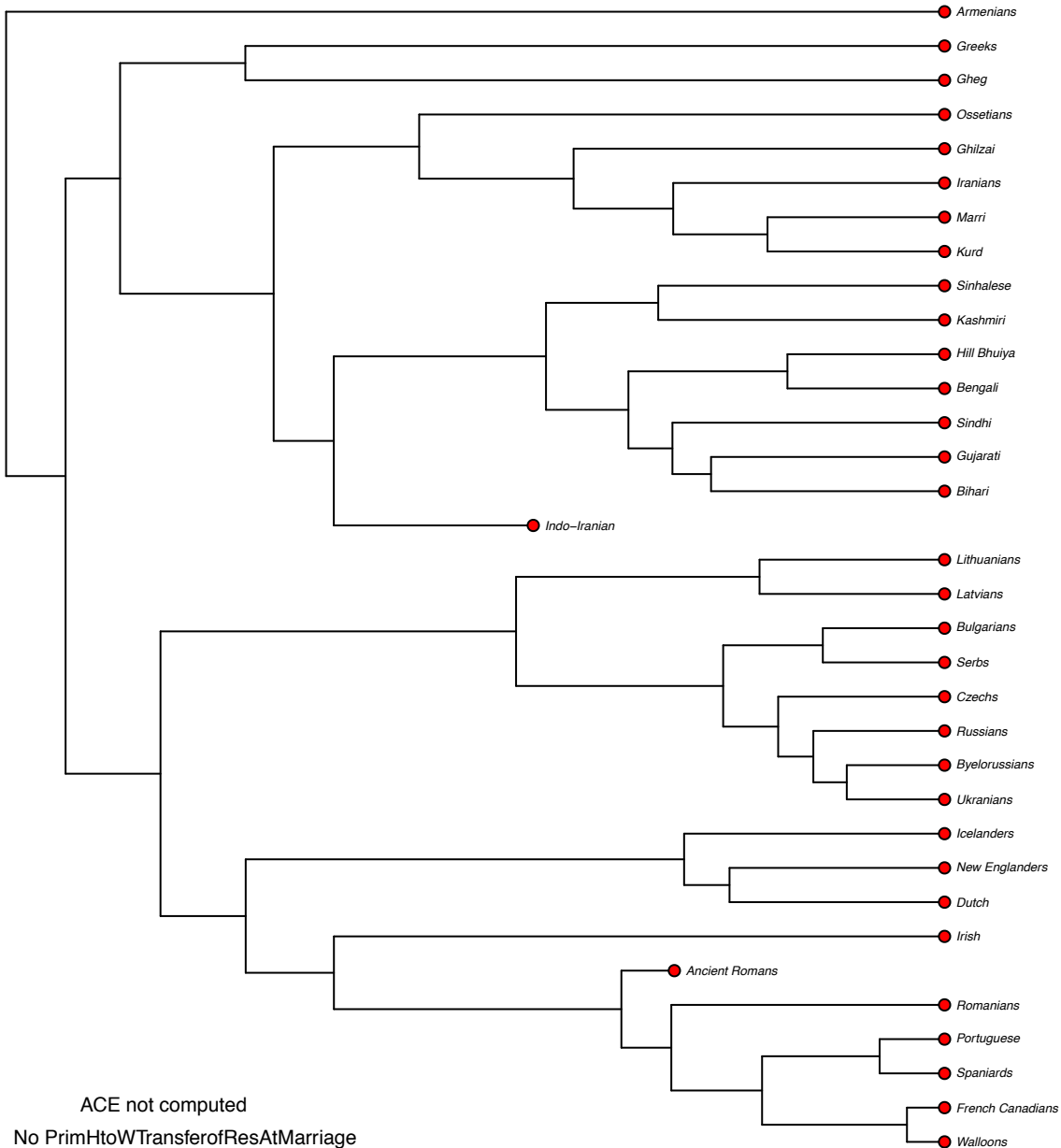

Armenians
 Greeks
 Gheg
 Ossetians
 Ghilzai
 Iranians
 Marri
 Kurd
 Sinhalese
 Kashmiri
 Hill Bhuiya
 Bengali
 Sindhi
 Gujarati
 Bihari
 Indo-Iranian
 Lithuanians
 Latvians
 Bulgarians
 Serbs
 Czechs
 Russians
 Byelorussians
 Ukrainians
 Icelanders
 New Englanders
 Dutch
 Irish
 Ancient Romans
 Romanians
 Portuguese
 Spaniards
 French Canadians
 Wallons

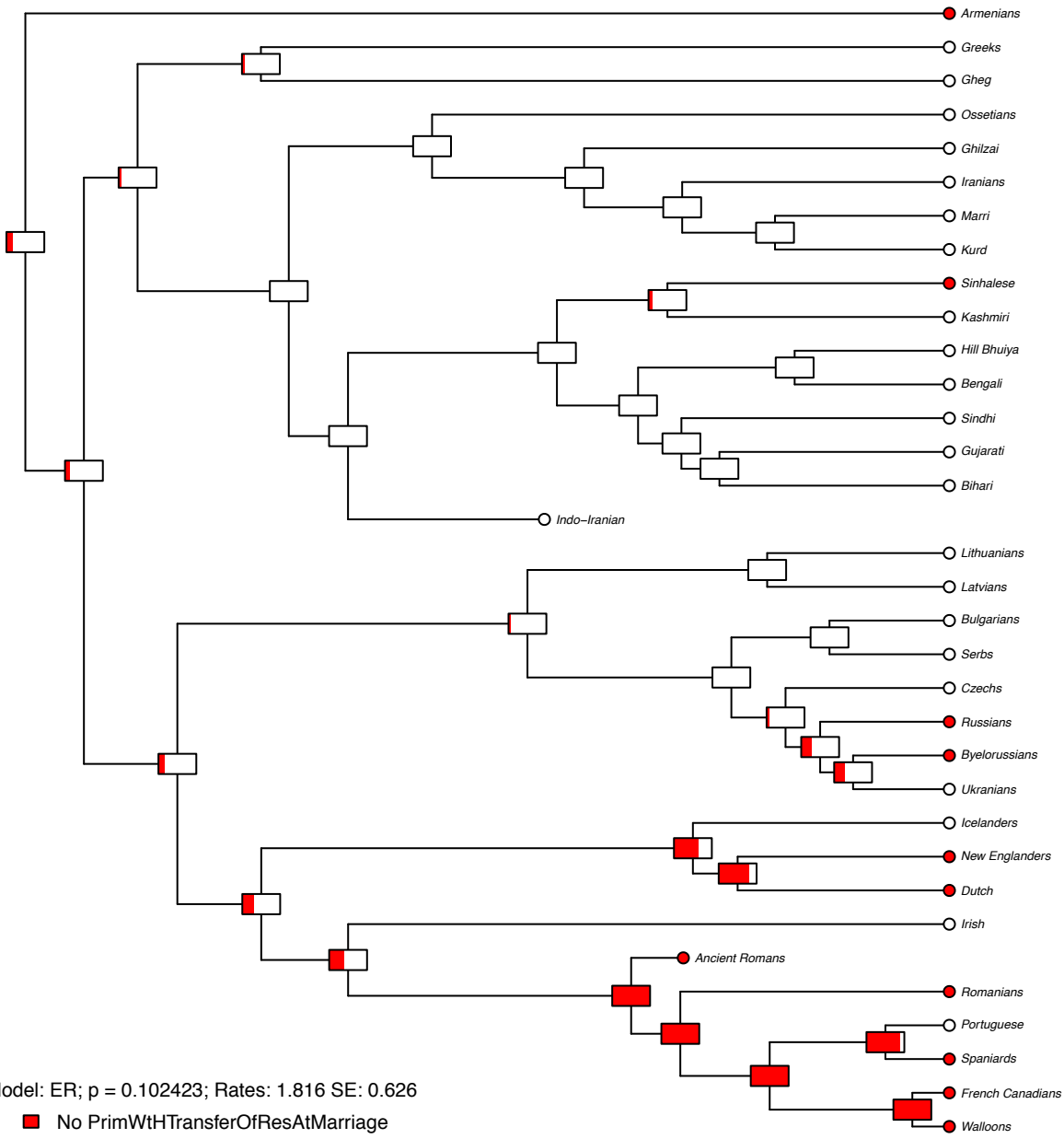

Model: ER; $p = 0.102423$; Rates: 1.816 SE: 0.626

- No PrimWtHTransferOfResAtMarriage
- PrimWtHTransferOfResAtMarriage

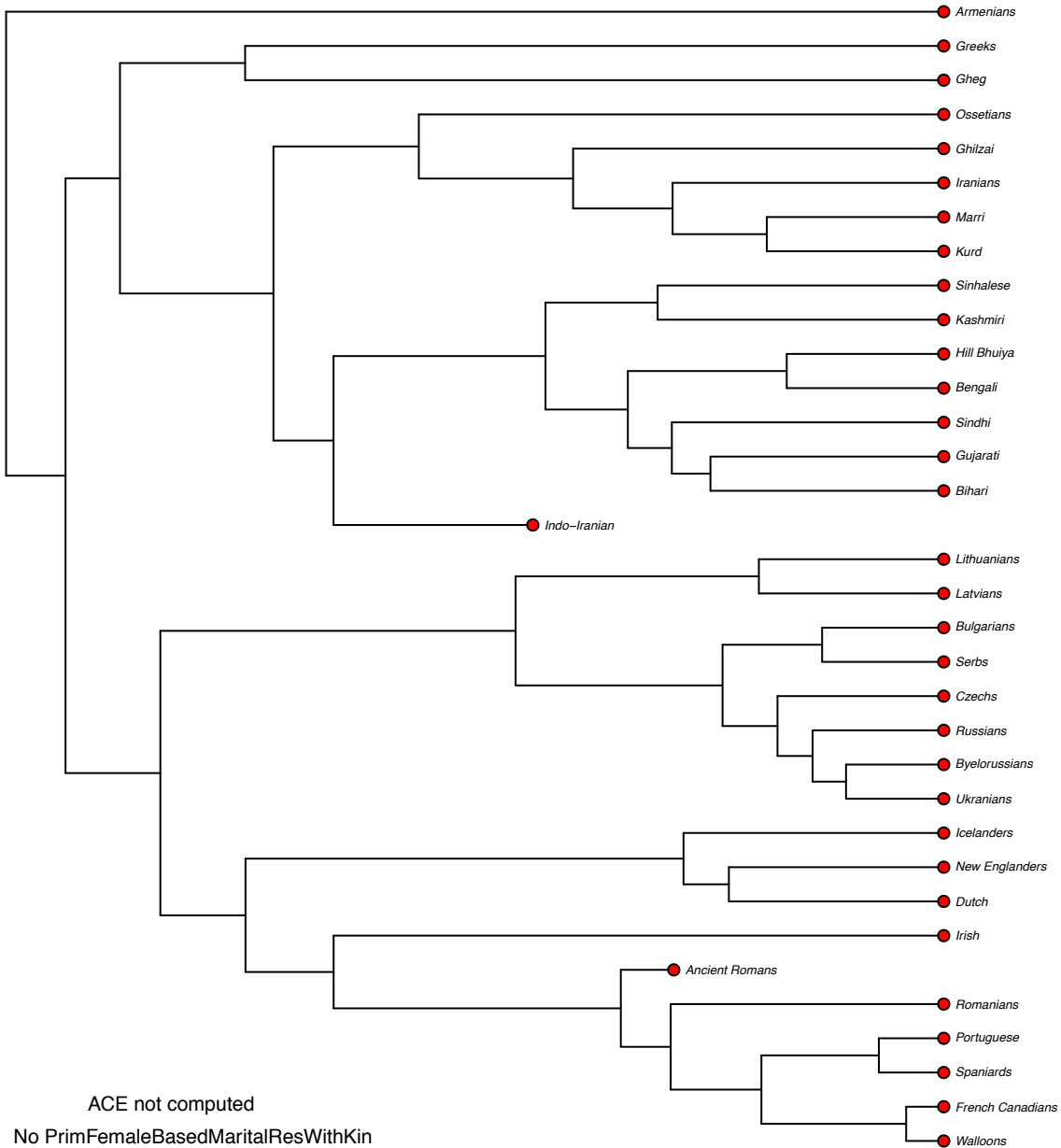

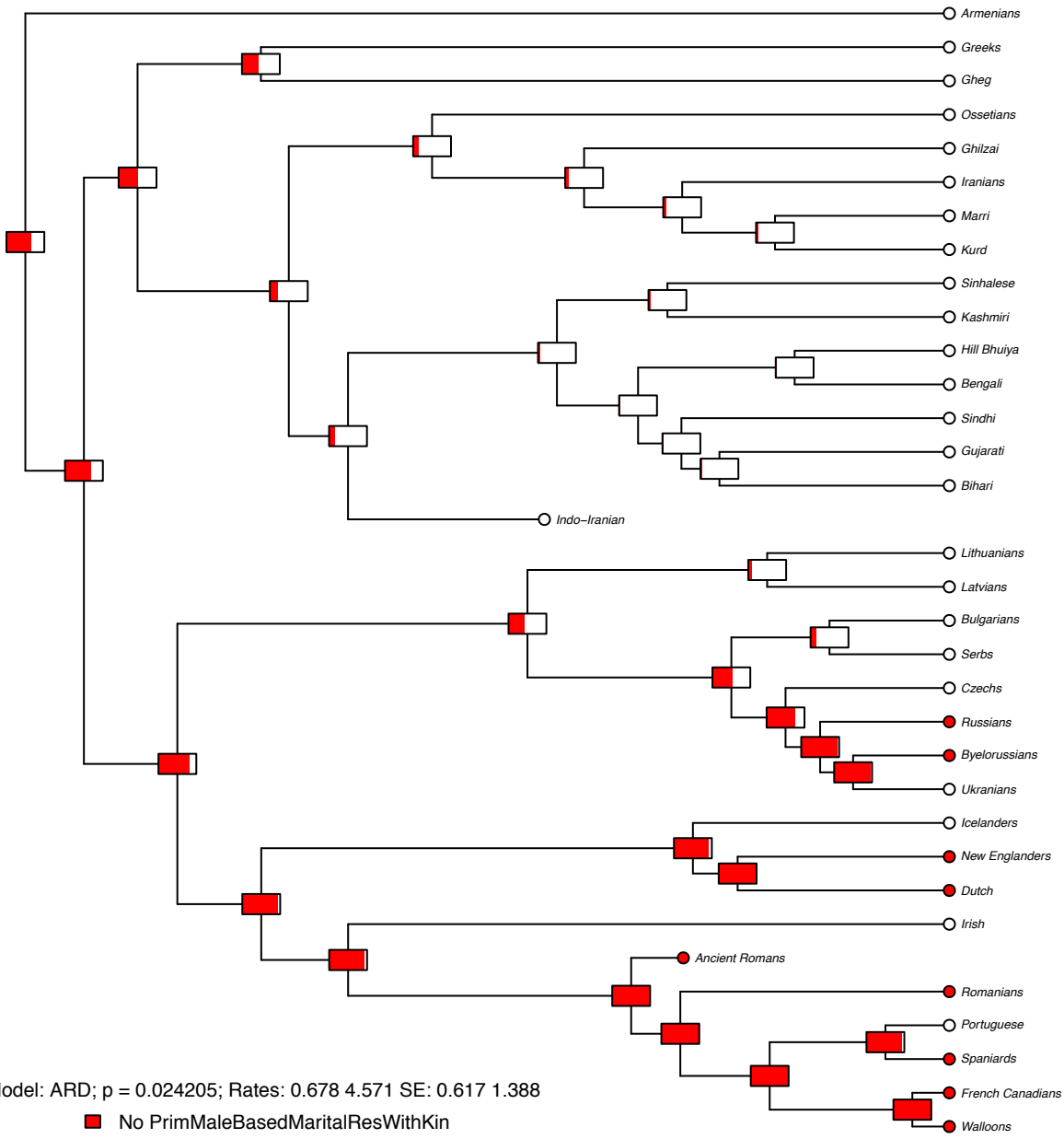

- Armenians
- Greeks
- Gheg
- Ossetians
- Ghilzai
- Iranian
- Marri
- Kurd
- Sinhalese
- Kashmiri
- Hill Bhuiya
- Bengali
- Sindhi
- Gujarati
- Bihari
- Indo-Iranian
- Lithuanians
- Latvians
- Bulgarians
- Serbs
- Czechs
- Russians
- Byelorussians
- Ukrainians
- Icelanders
- New Englanders
- Dutch
- Irish
- Ancient Romans
- Romanians
- Portuguese
- Spaniards
- French Canadians
- Walloons

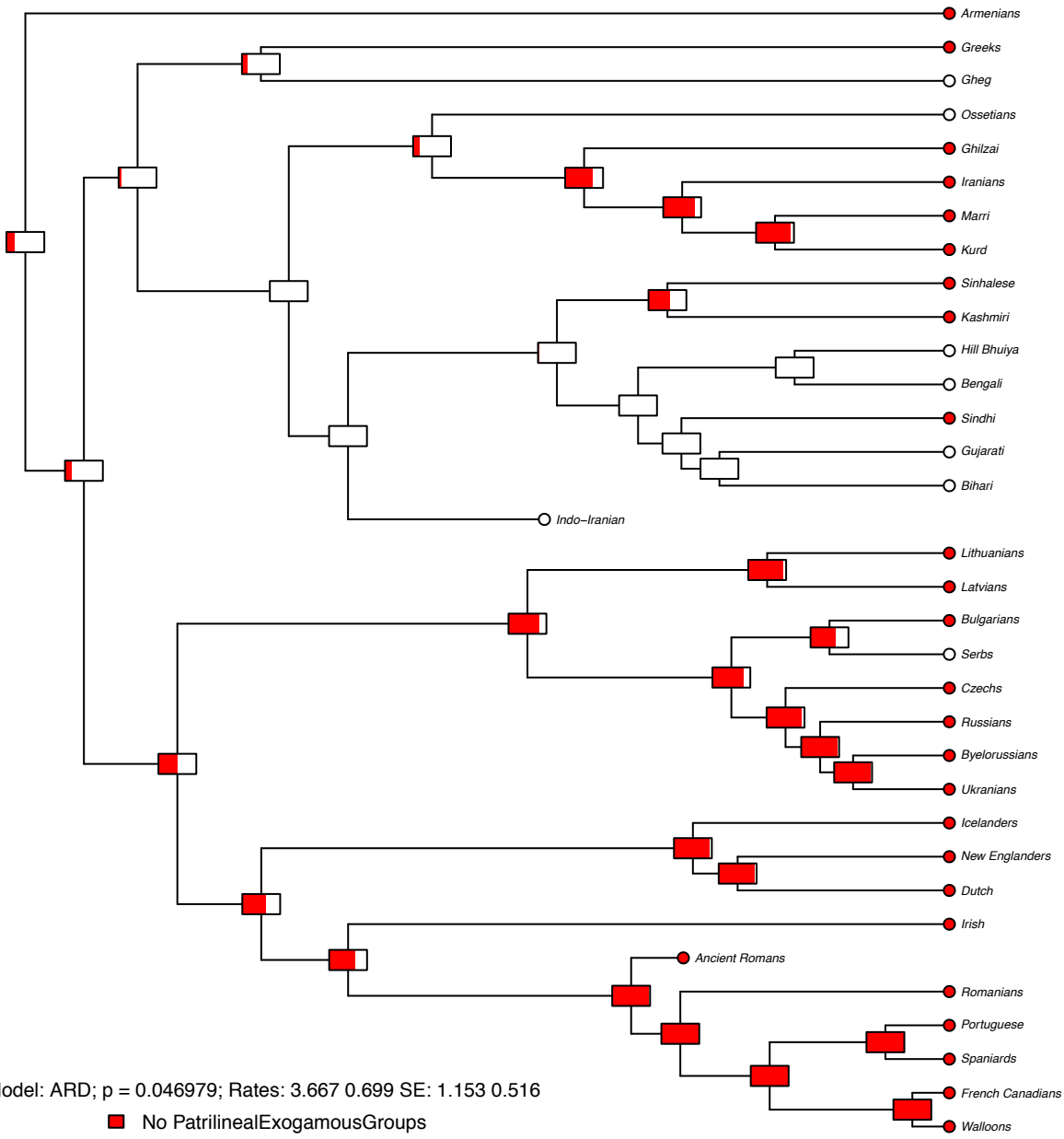

Model: ARD; $p = 0.046979$; Rates: 3.667 0.699 SE: 1.153 0.516

- No Patrilineal Exogamous Groups
- Patrilineal Exogamous Groups

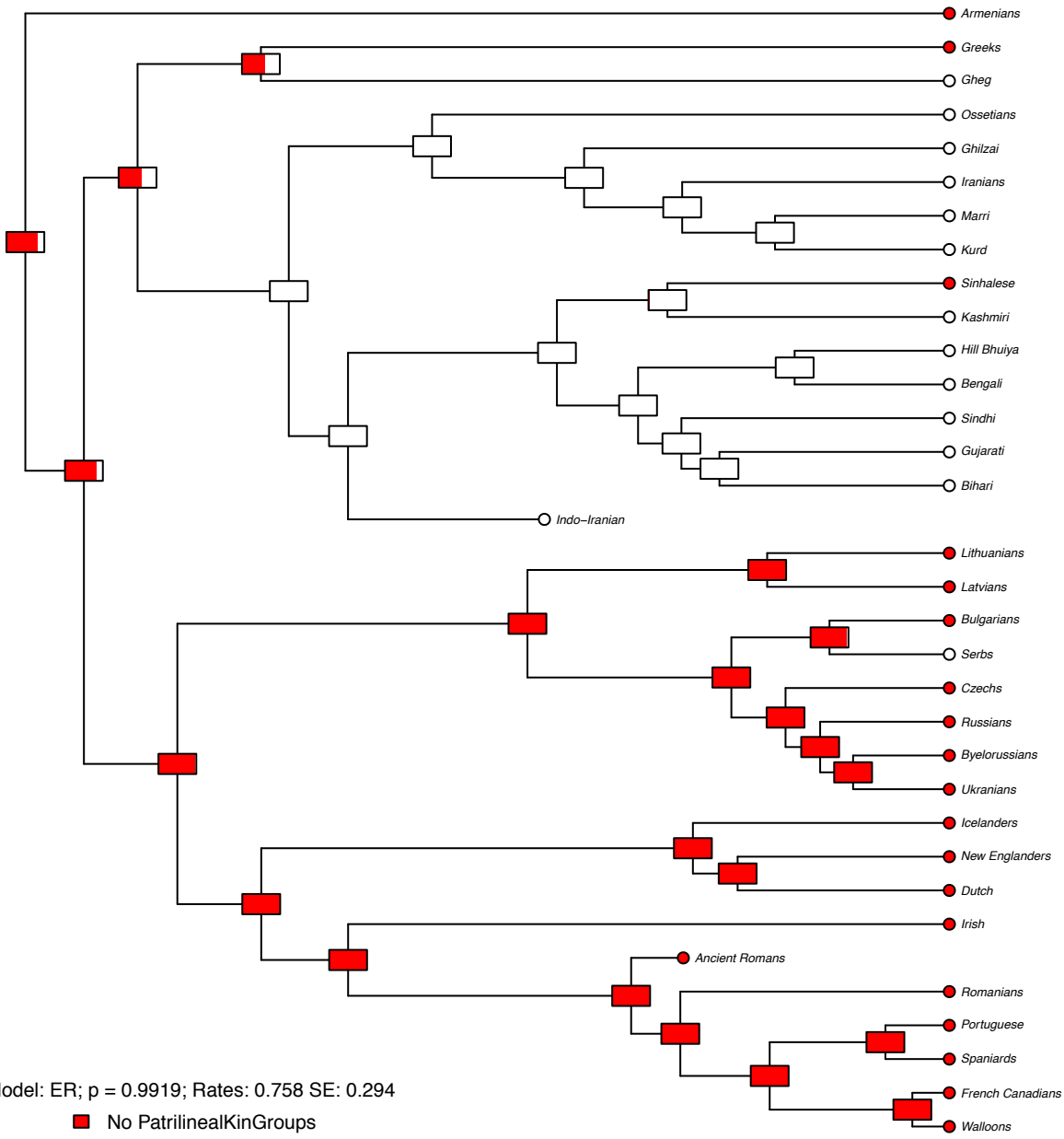

Model: ER; $p = 0.9919$; Rates: 0.758 SE: 0.294

- No PatrilinealKinGroups
- PatrilinealKinGroups

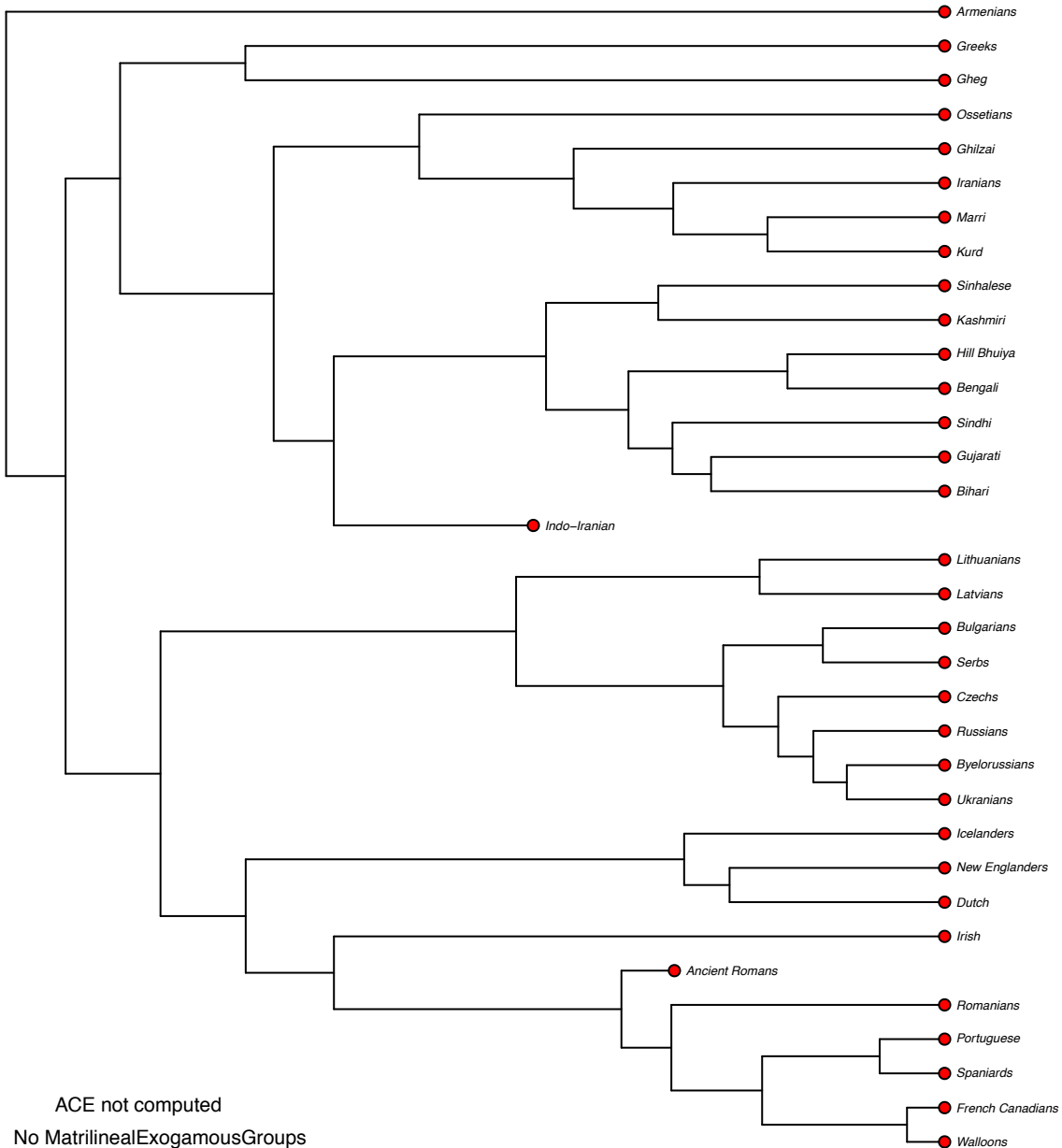

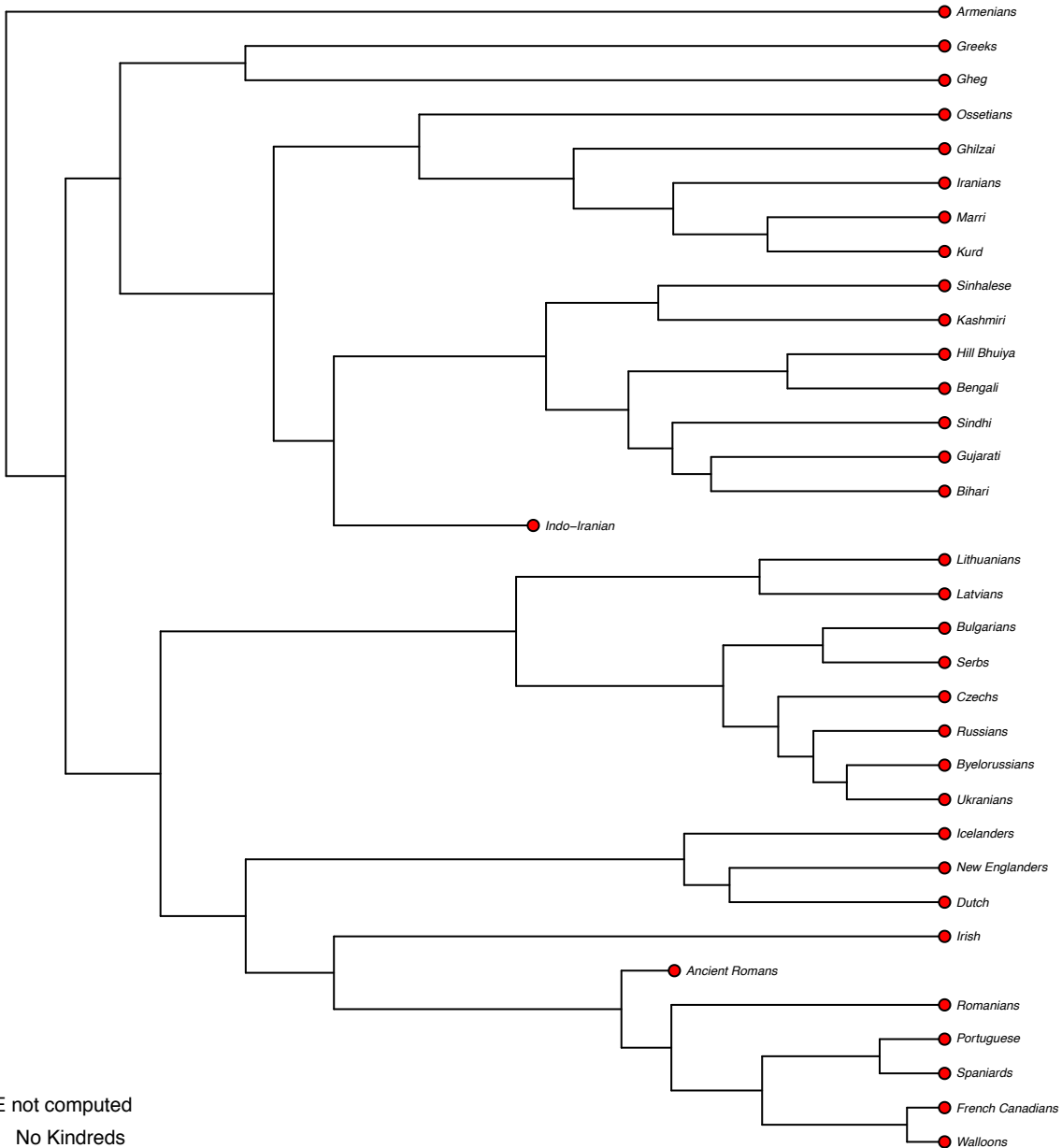

ACE not computed

- No Kindreds
- Kindreds

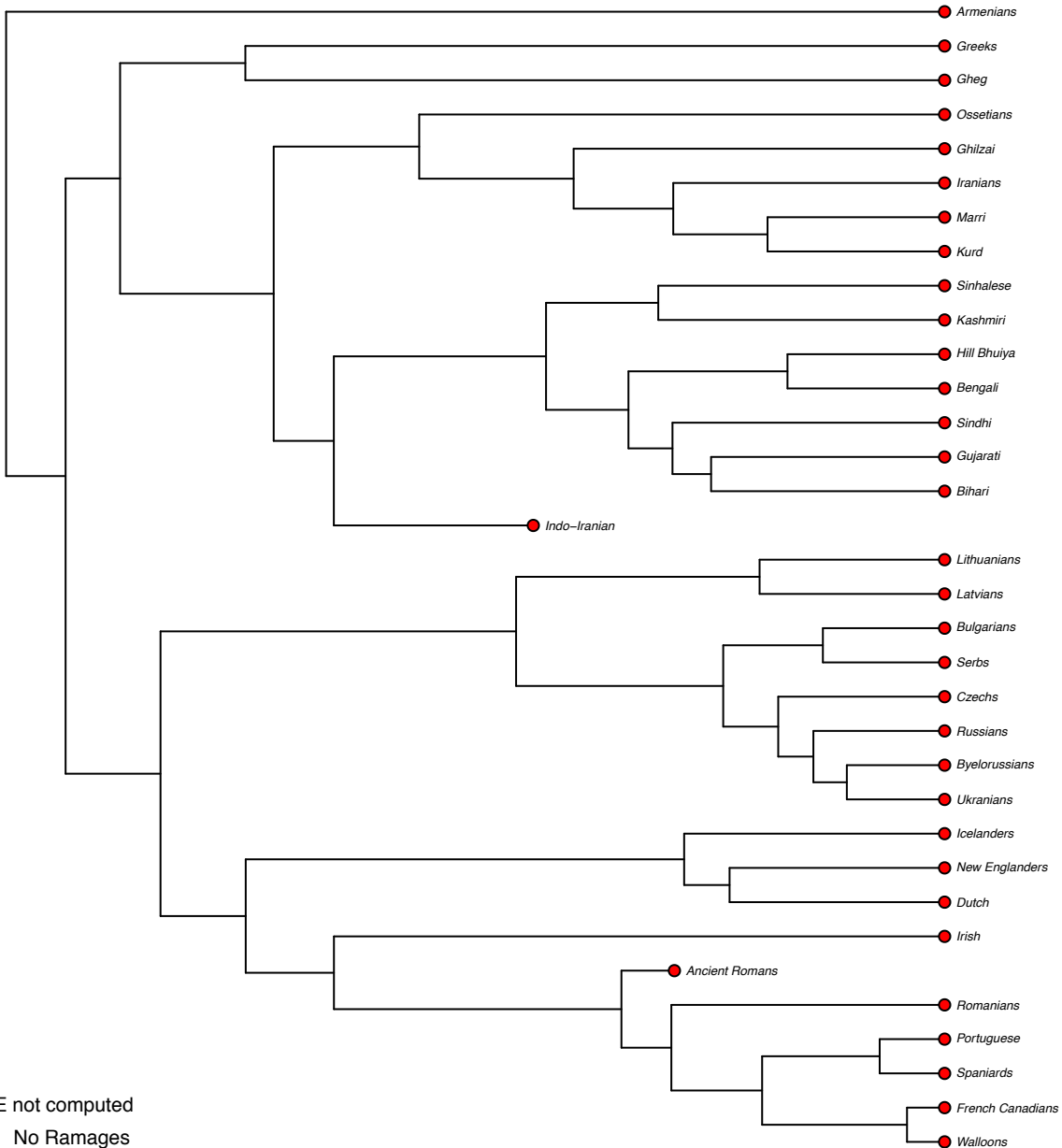

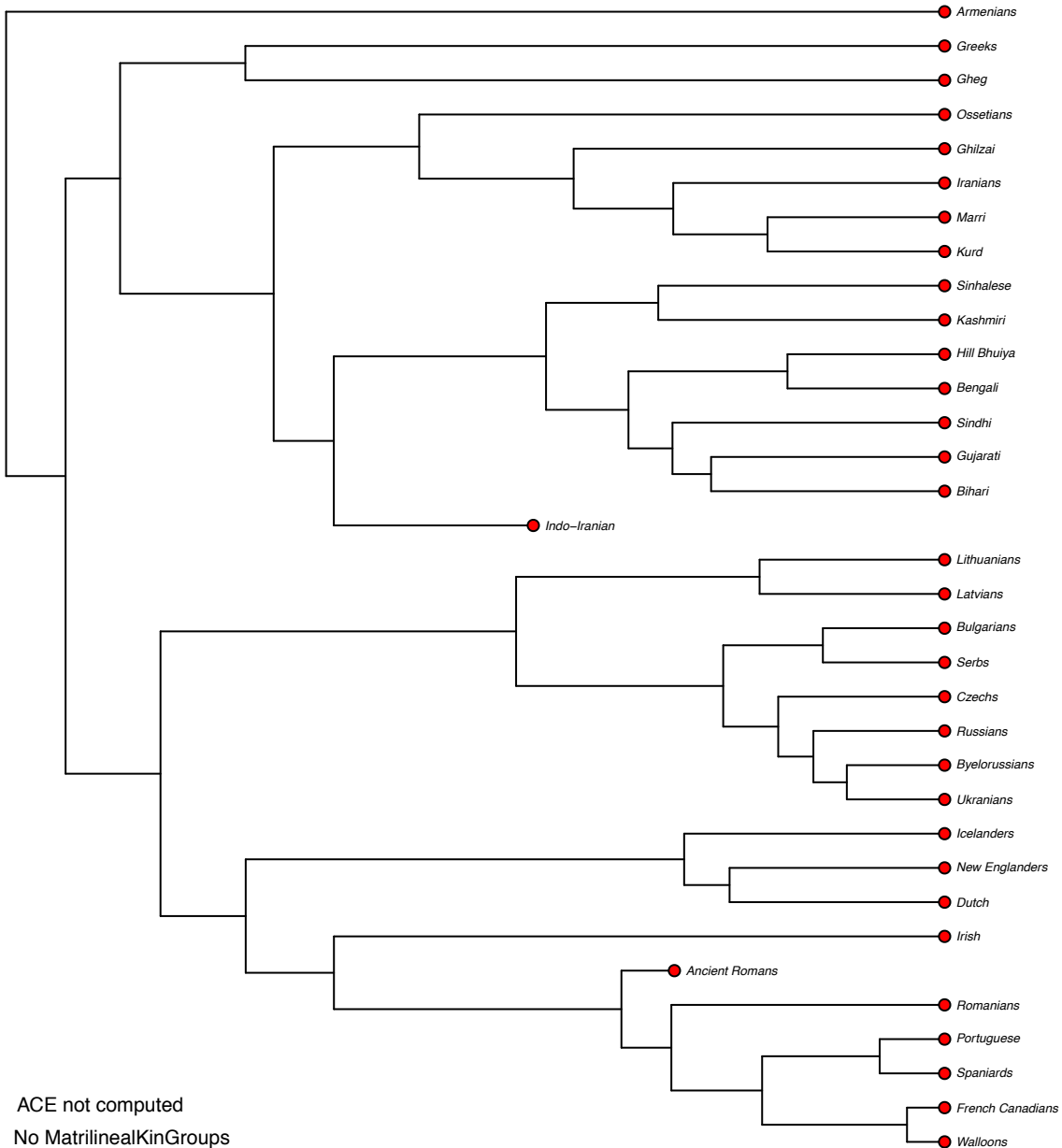

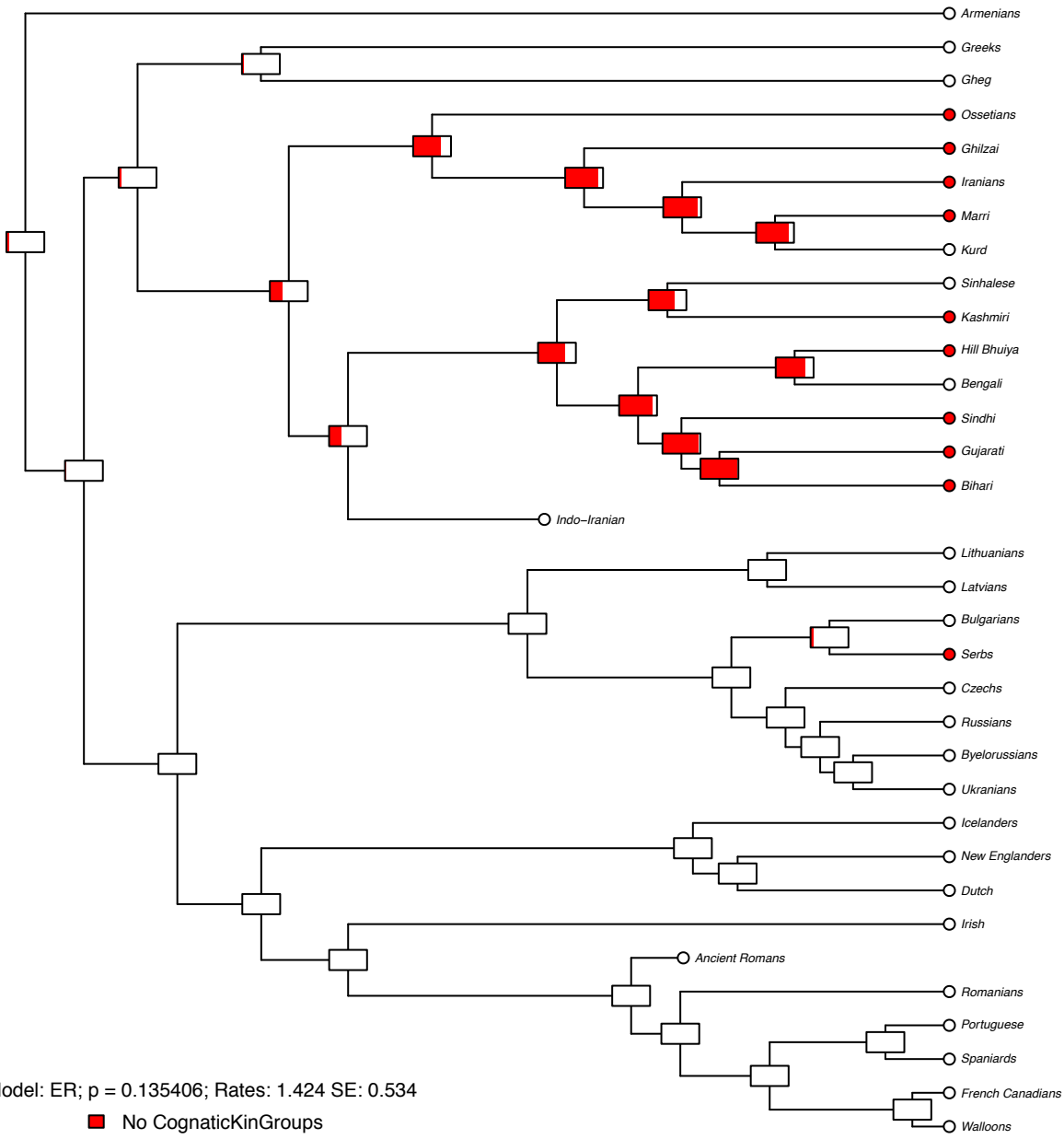

Model: ER; $p = 0.135406$; Rates: 1.424 SE: 0.534

- No CognaticKinGroups
- CognaticKinGroups

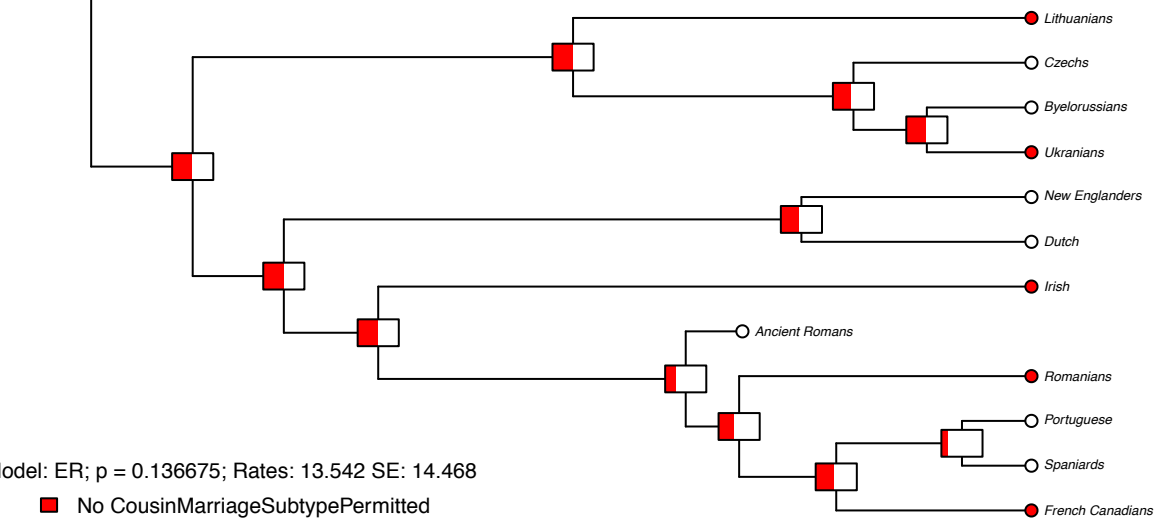
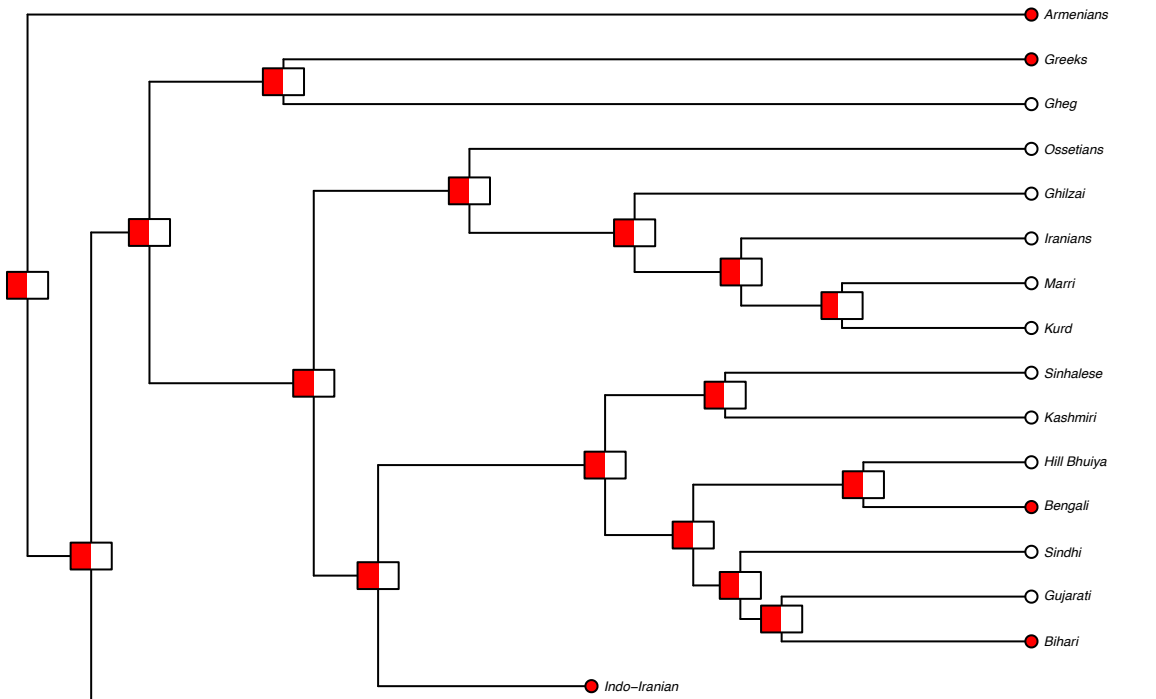

Model: ER; $p = 0.136675$; Rates: 13.542 SE: 14.468

- No Cousin Marriage Subtype Permitted
- Cousin Marriage Subtype Permitted

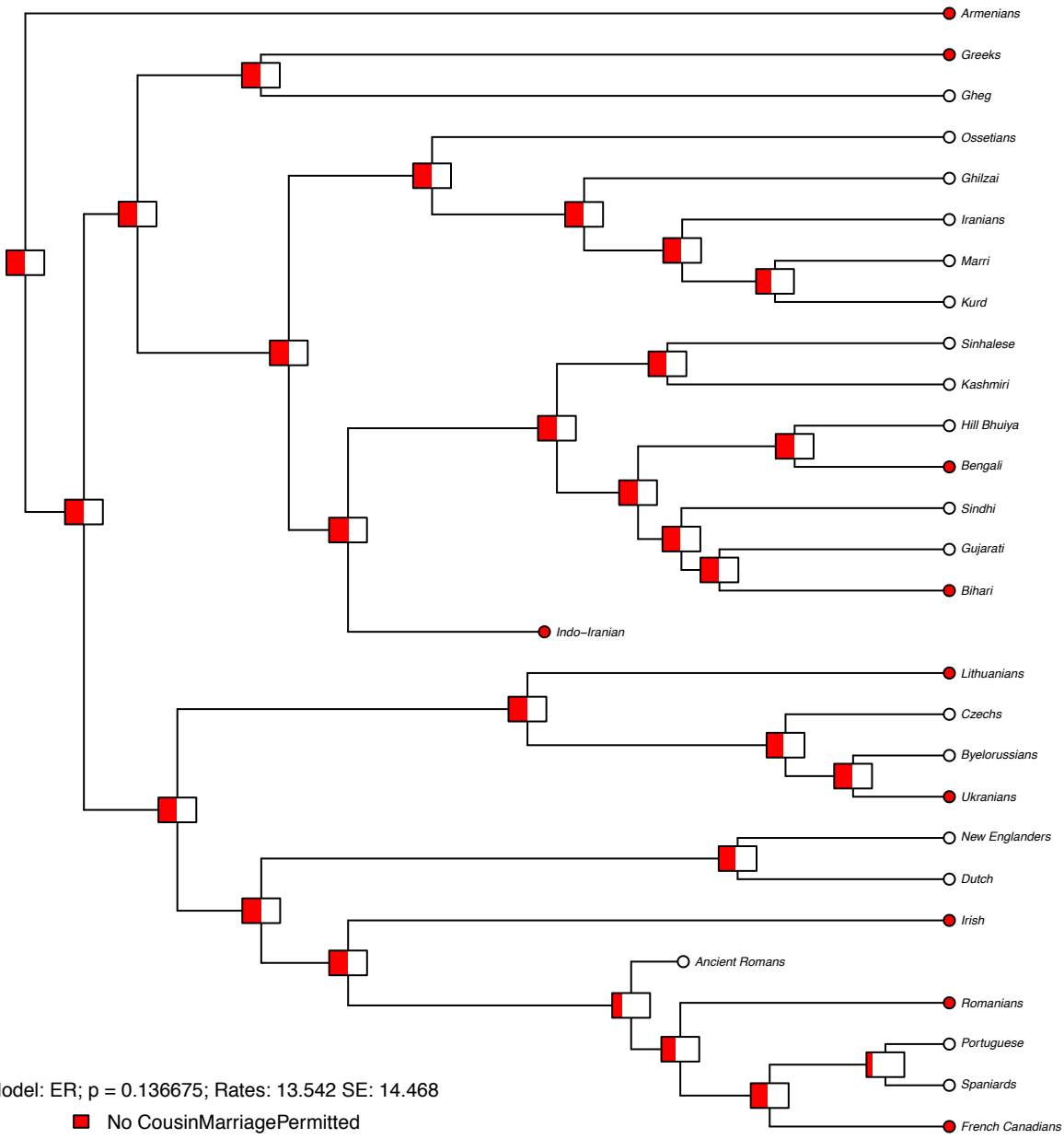

Model: ER; $p = 0.136675$; Rates: 13.542 SE: 14.468

- No Cousin Marriage Permitted
- Cousin Marriage Permitted

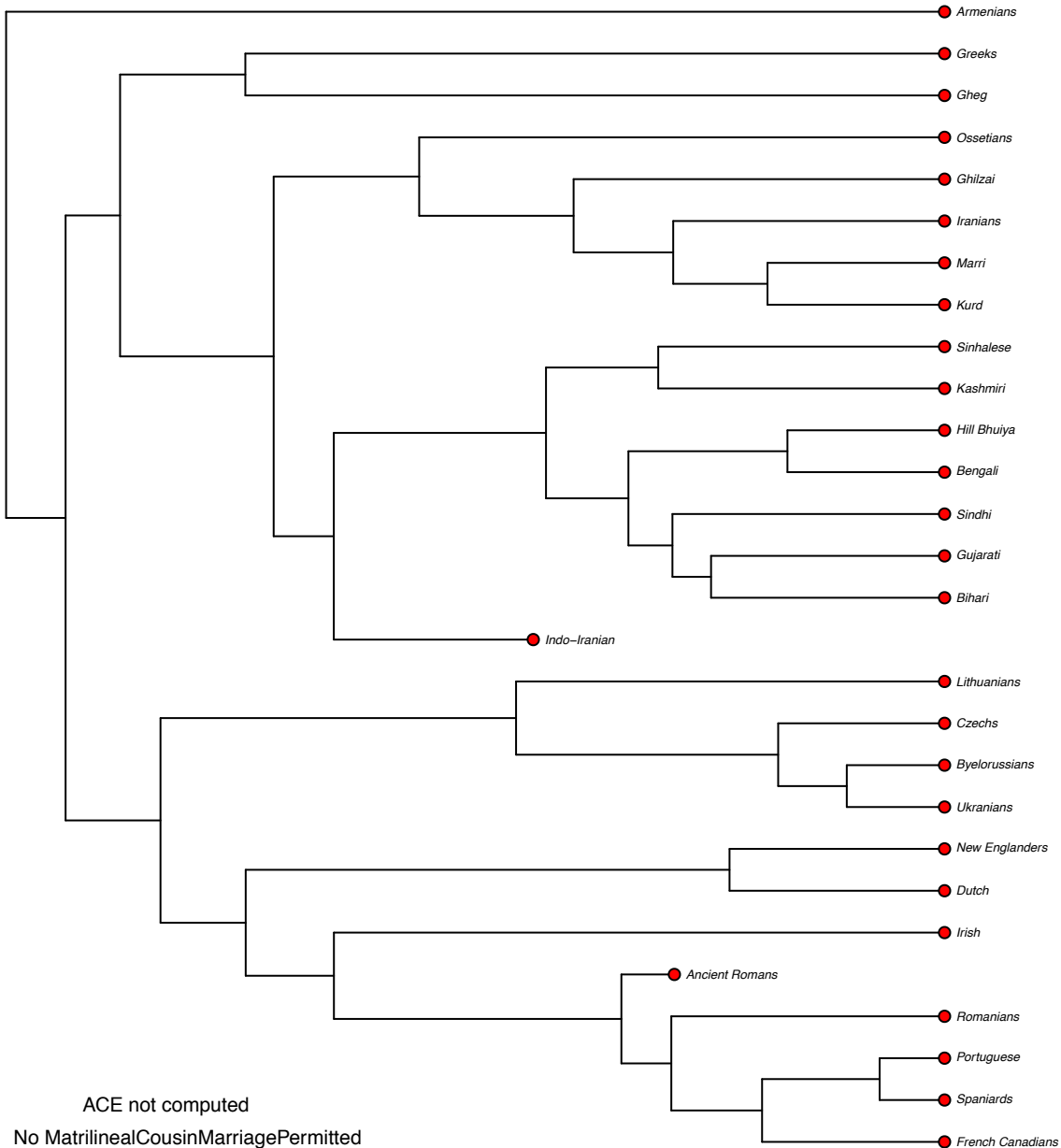

● Armenians

● Greeks

● Ghag

● Ossetians

● Ghilzai

● Iranians

● Marri

● Kurd

● Sinhalese

● Kashmiri

● Hill Bhuiya

● Bengali

● Sindhi

● Gujarati

● Bihari

● Indo-Iranian

● Lithuanians

● Czechs

● Byelorussians

● Ukrainians

● New Englanders

● Dutch

● Irish

● Ancient Romans

● Romanians

● Portuguese

● Spaniards

● French Canadians

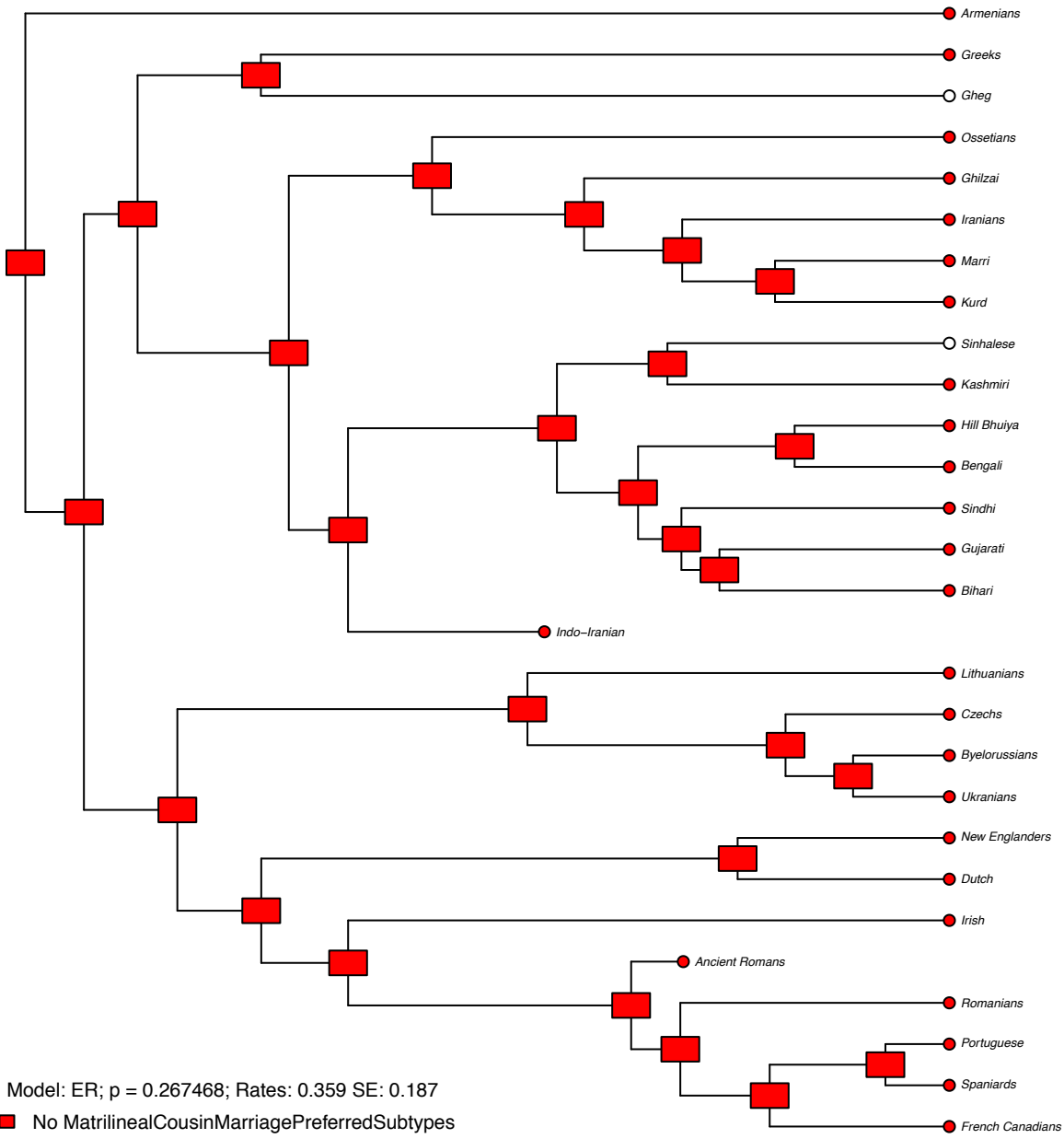

- Armenians
- Greeks
- Gheg
- Ossetians
- Ghilzai
- Iranians
- Marri
- Kurd
- Sinhalese
- Kashmiri
- Hill Bhuiya
- Bengali
- Sindhi
- Gujarati
- Bihari
- Indo-Iranian
- Lithuanians
- Czechs
- Byelorussians
- Ukrainians
- New Englanders
- Dutch
- Irish
- Ancient Romans
- Romanians
- Portuguese
- Spaniards
- French Canadians

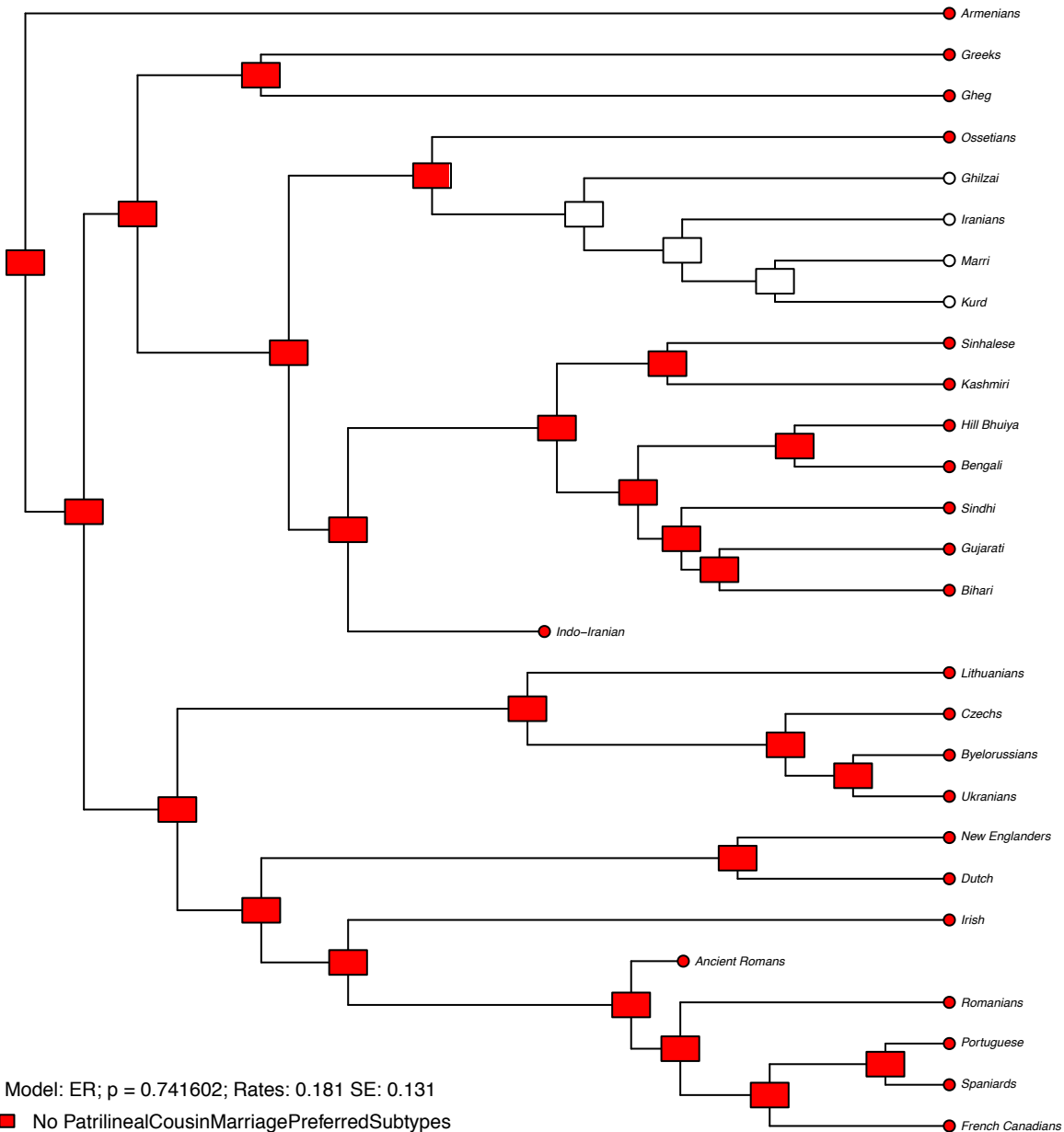

Model: ER; $p = 0.741602$; Rates: 0.181 SE: 0.131

- No PatrilinealCousinMarriagePreferredSubtypes
- PatrilinealCousinMarriagePreferredSubtypes

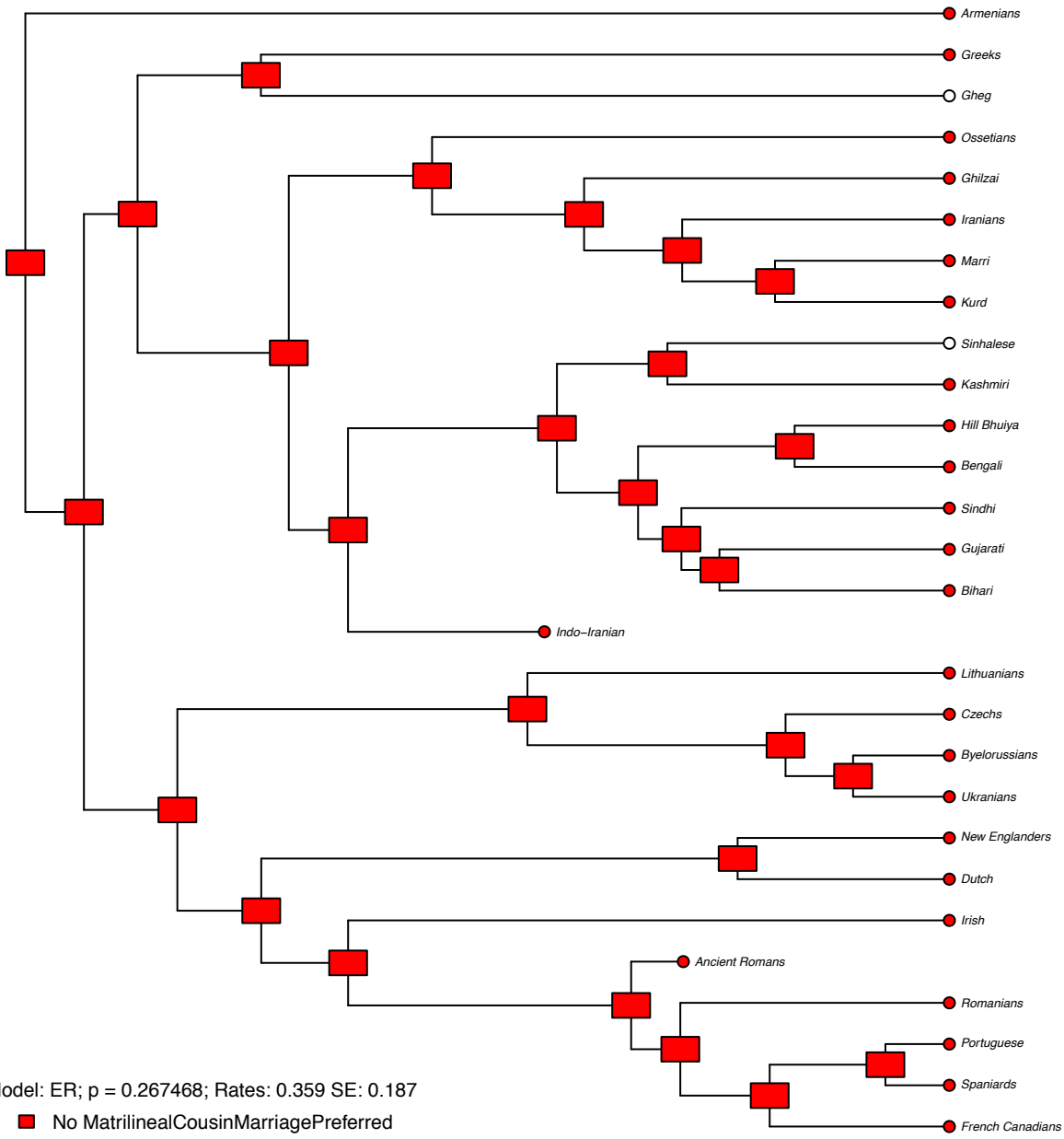

Model: ER; $p = 0.267468$; Rates: 0.359 SE: 0.187

- No MatrilinealCousinMarriagePreferred
- MatrilinealCousinMarriagePreferred

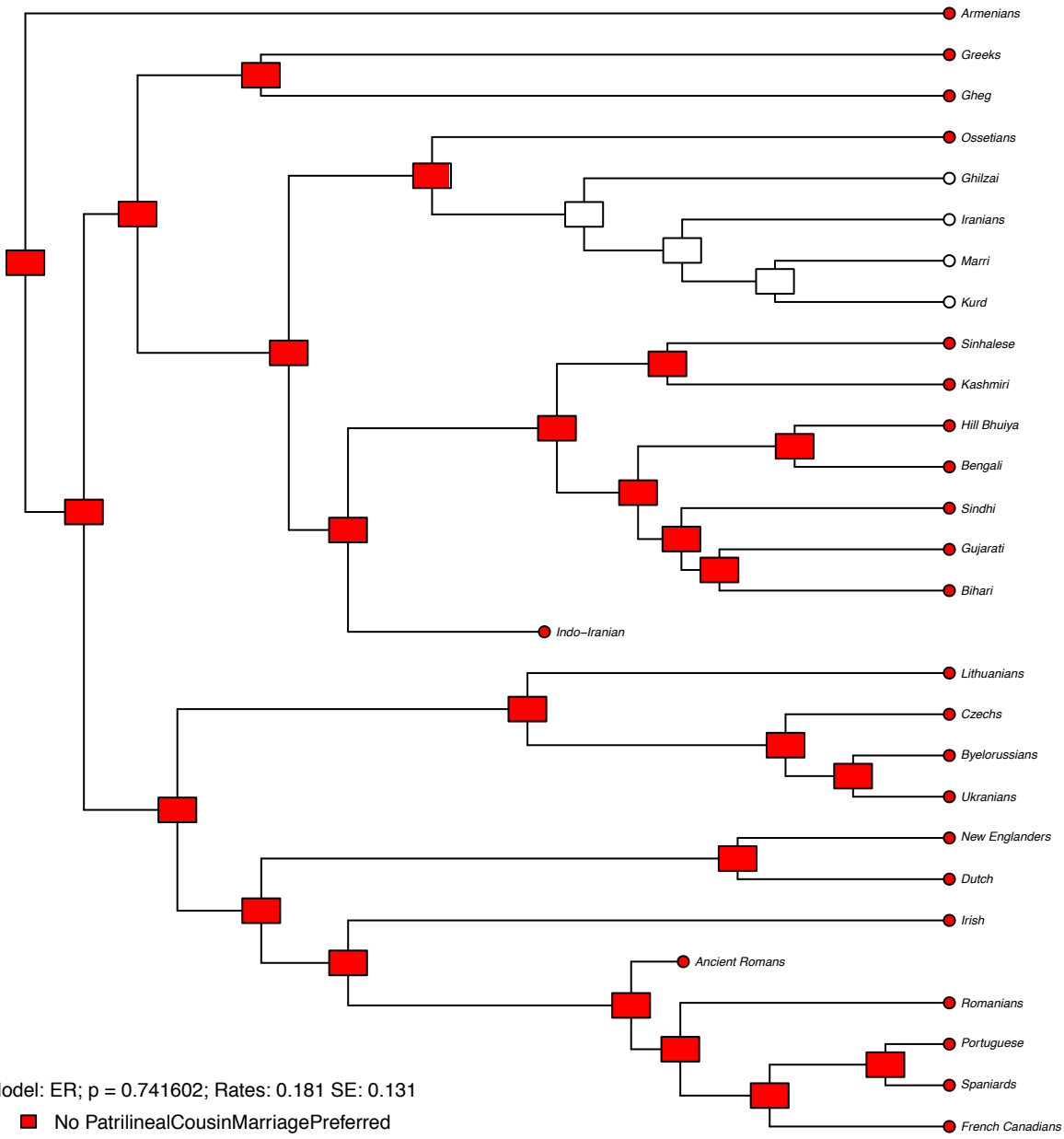

Model: ER; $p = 0.741602$; Rates: 0.181 SE: 0.131

- No PatrilinealCousinMarriagePreferred
- PatrilinealCousinMarriagePreferred

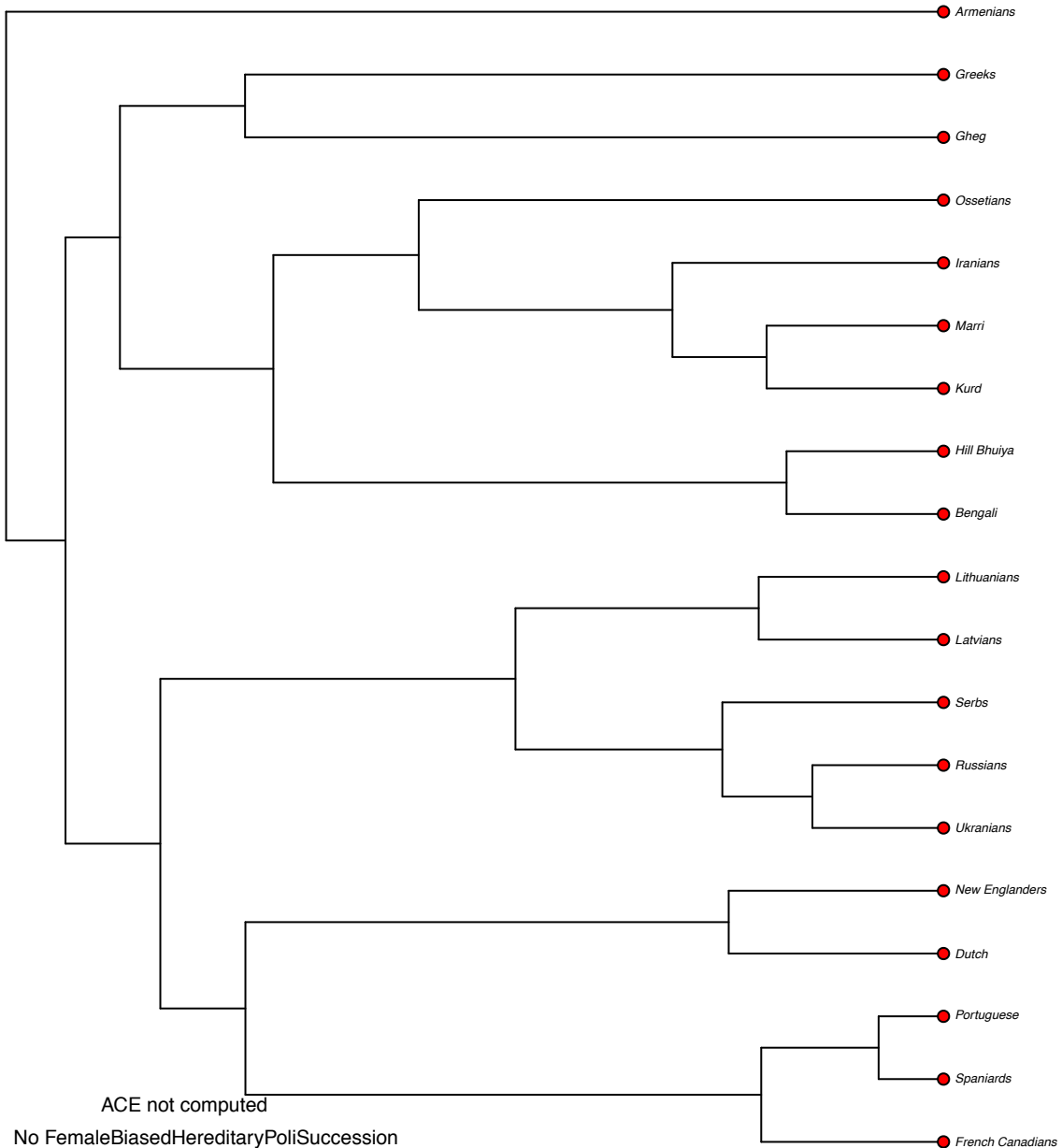

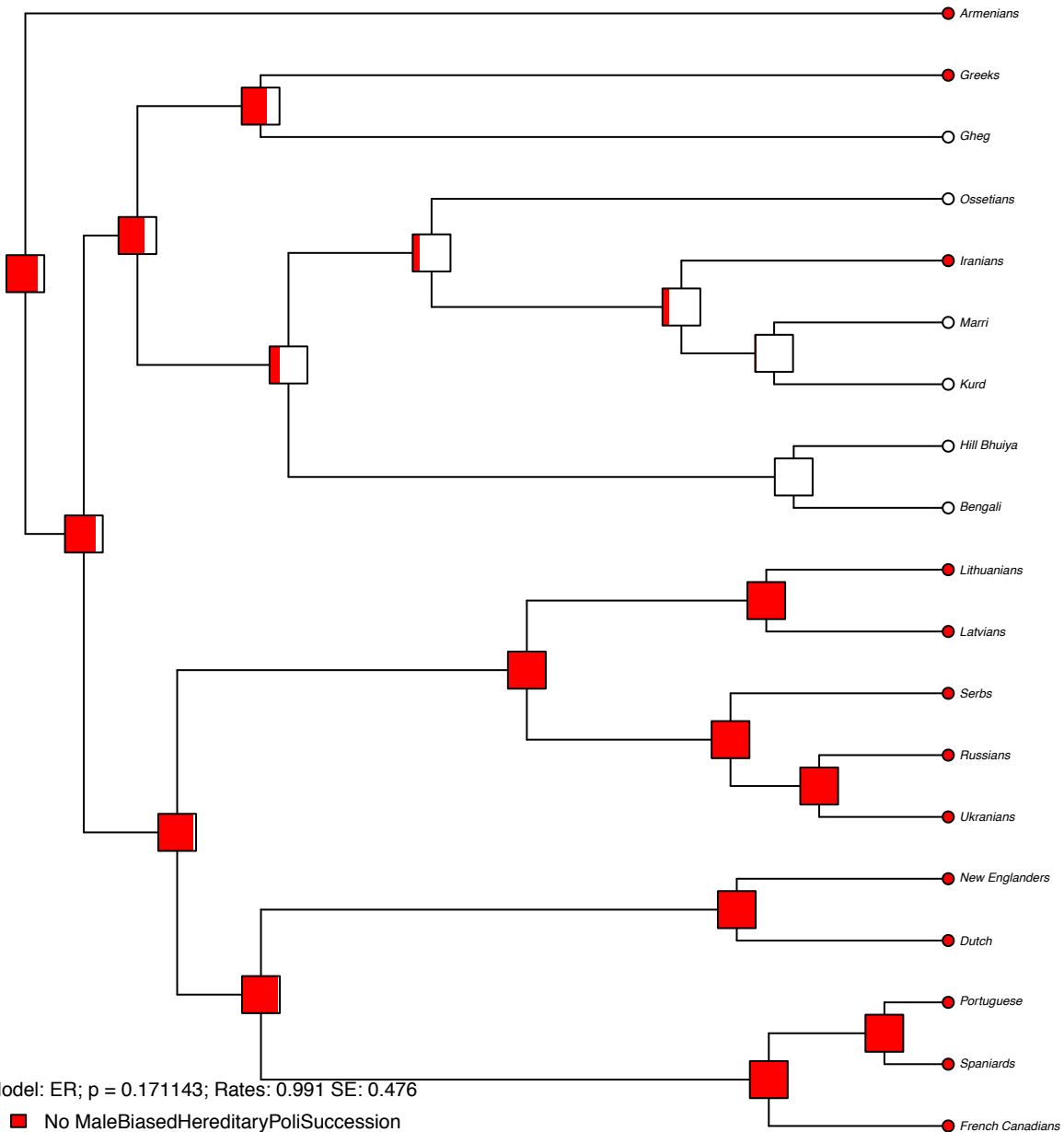

- Armenians
- Greeks
- Ghag
- Ossetians
- Iranians
- Marri
- Kurd
- Hill Bhuiya
- Bengali
- Lithuanians
- Latvians
- Serbs
- Russians
- Ukrainians
- New Englanders
- Dutch
- Portuguese
- Spaniards
- French Canadians

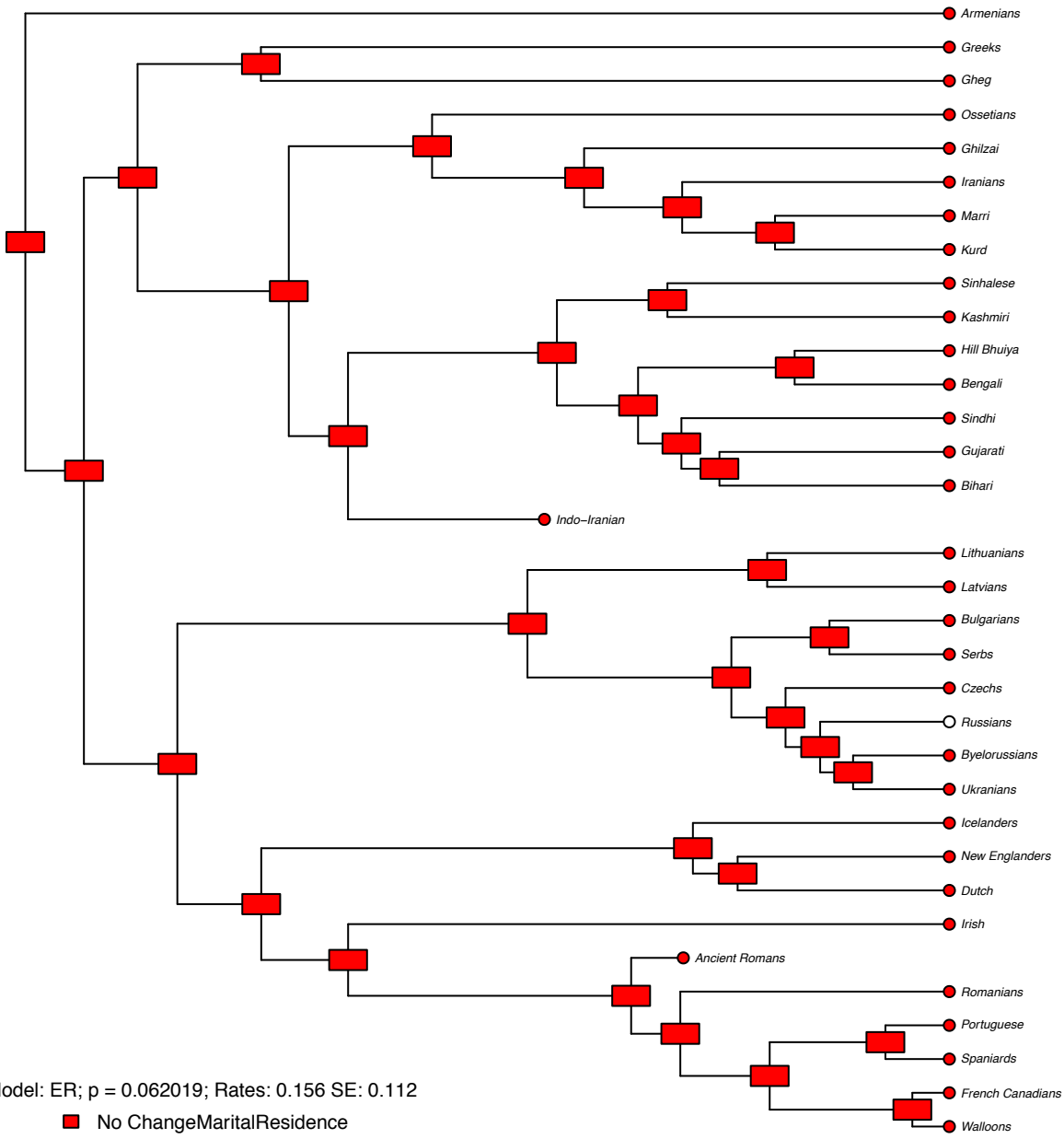

Model: ER; $p = 0.062019$; Rates: 0.156 SE: 0.112

- No ChangeMaritalResidence
- ChangeMaritalResidence

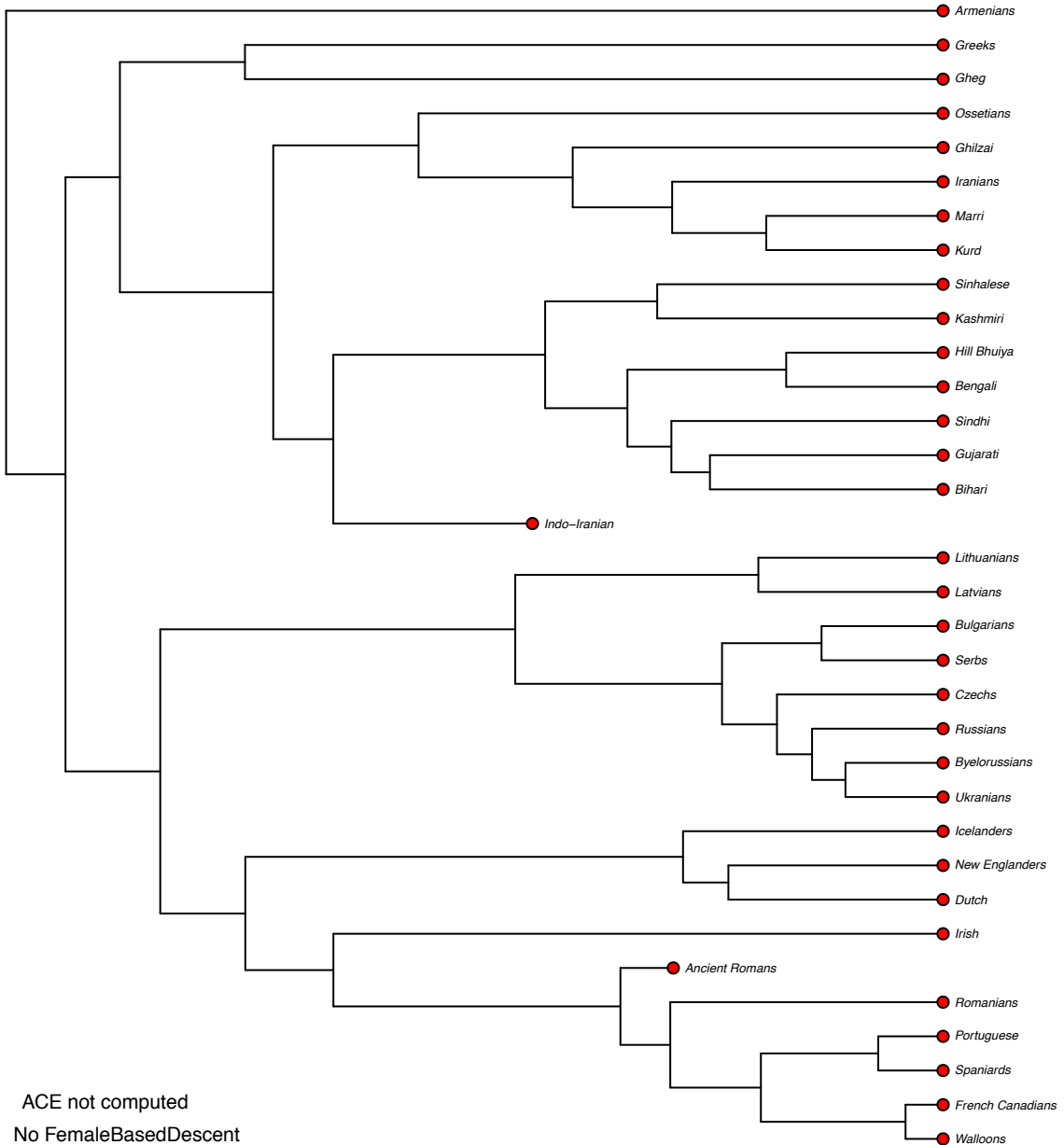

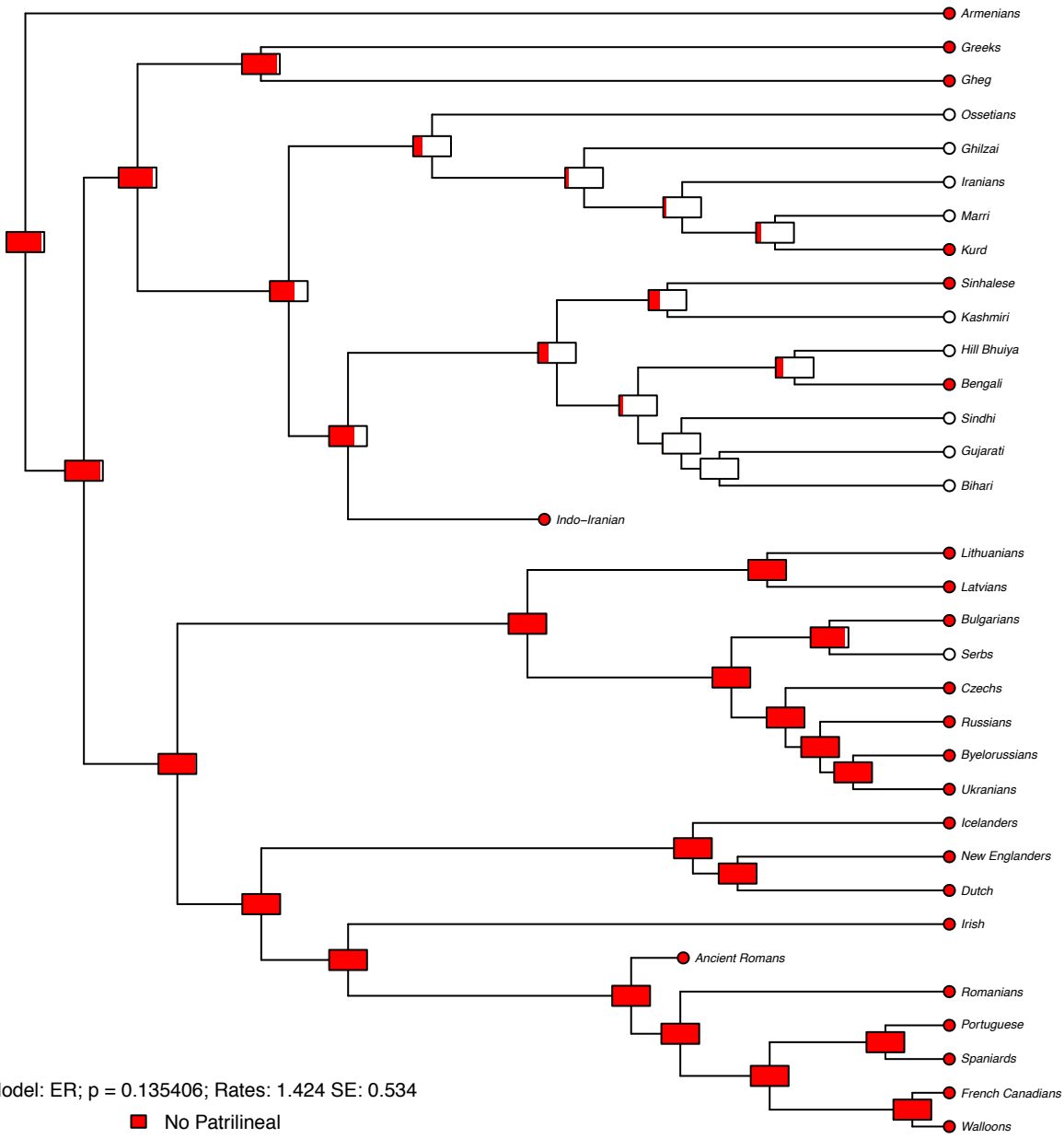

Model: ER; $p = 0.135406$; Rates: 1.424 SE: 0.534

■ No Patrilineal
 □ Patrilineal

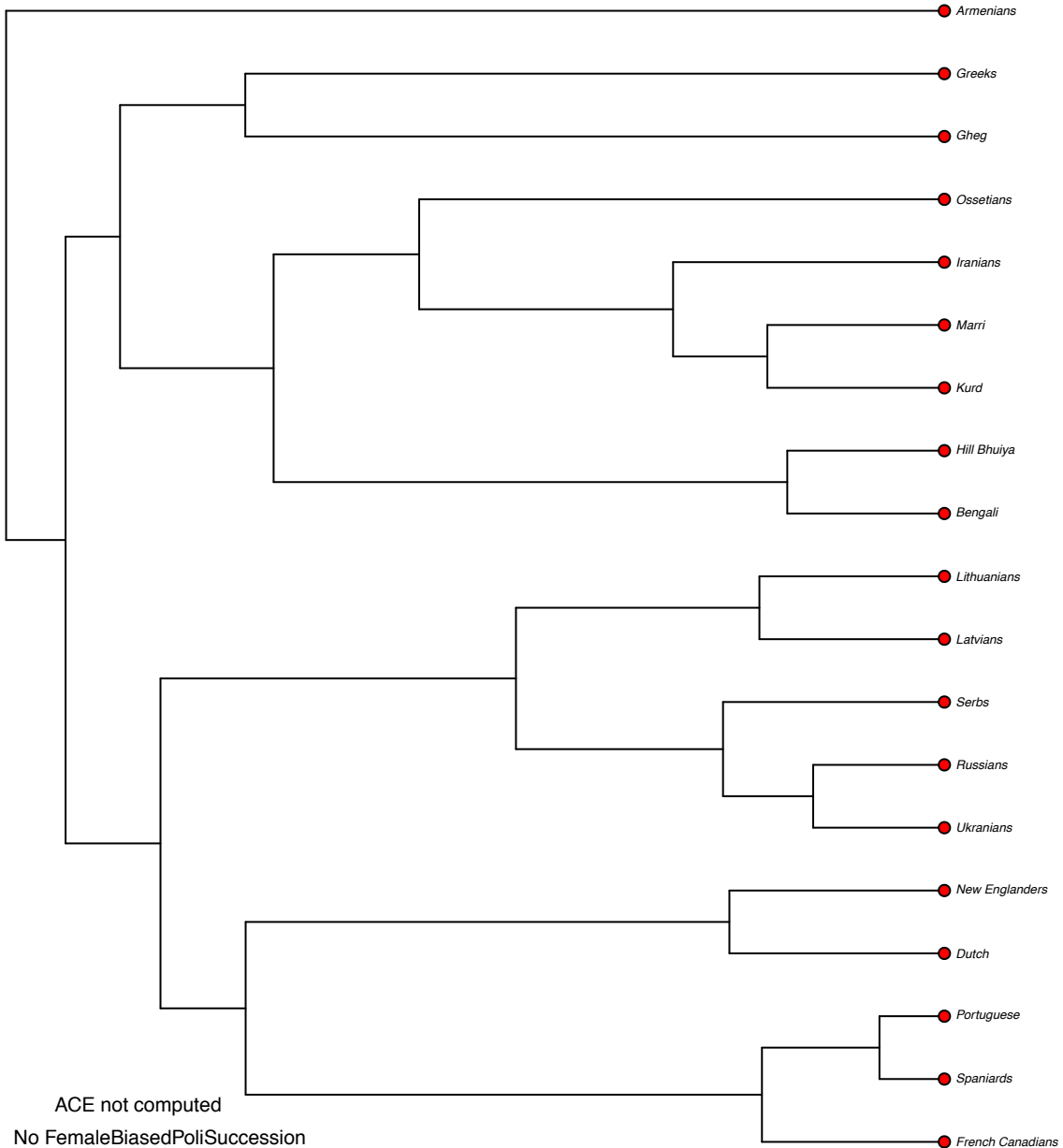

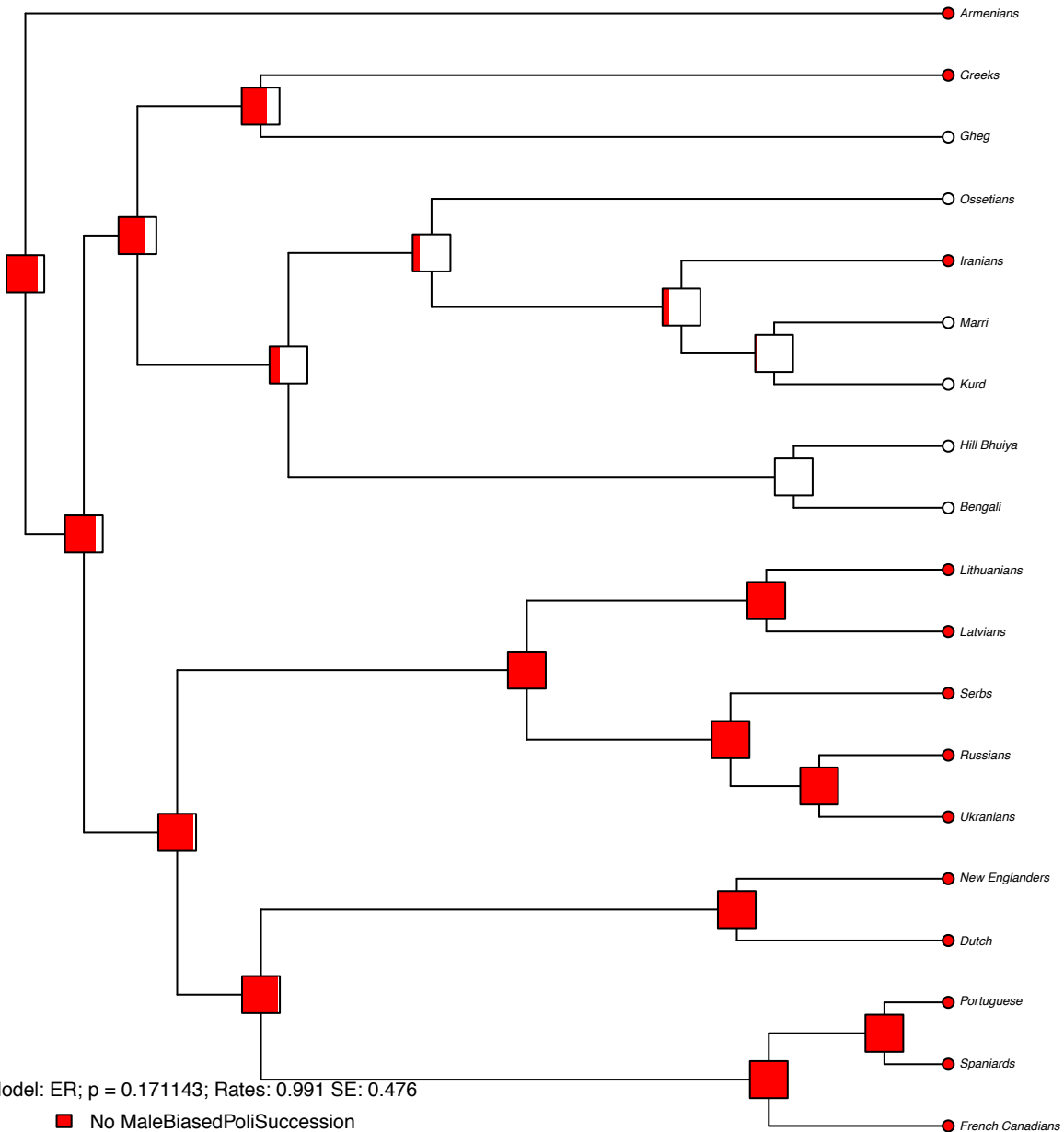

- Armenians
- Greeks
- Ghag
- Ossetians
- Iranians
- Marri
- Kurd
- Hill Bhuiya
- Bengali
- Lithuanians
- Latvians
- Serbs
- Russians
- Ukrainians
- New Englanders
- Dutch
- Portuguese
- Spaniards
- French Canadians

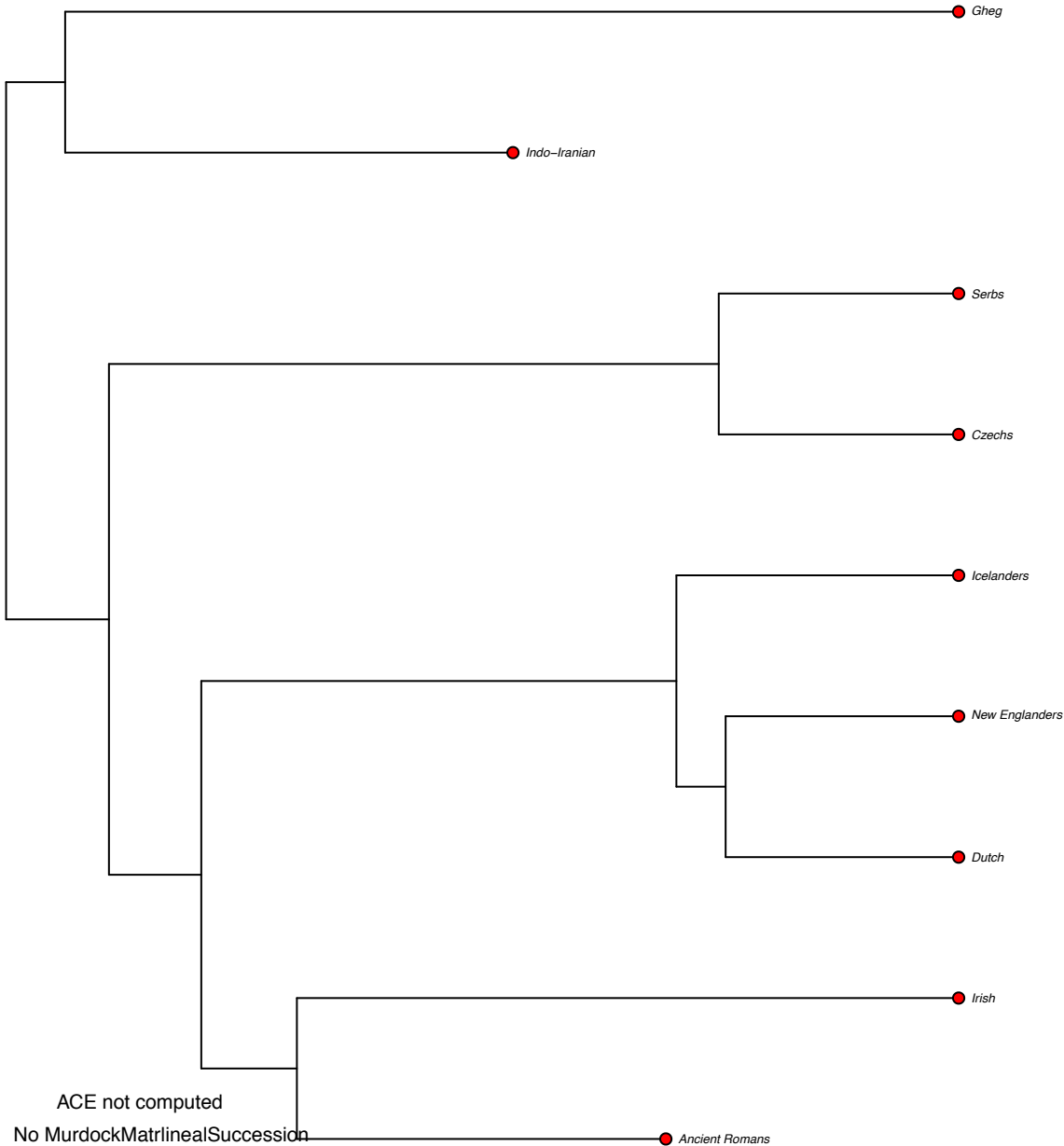

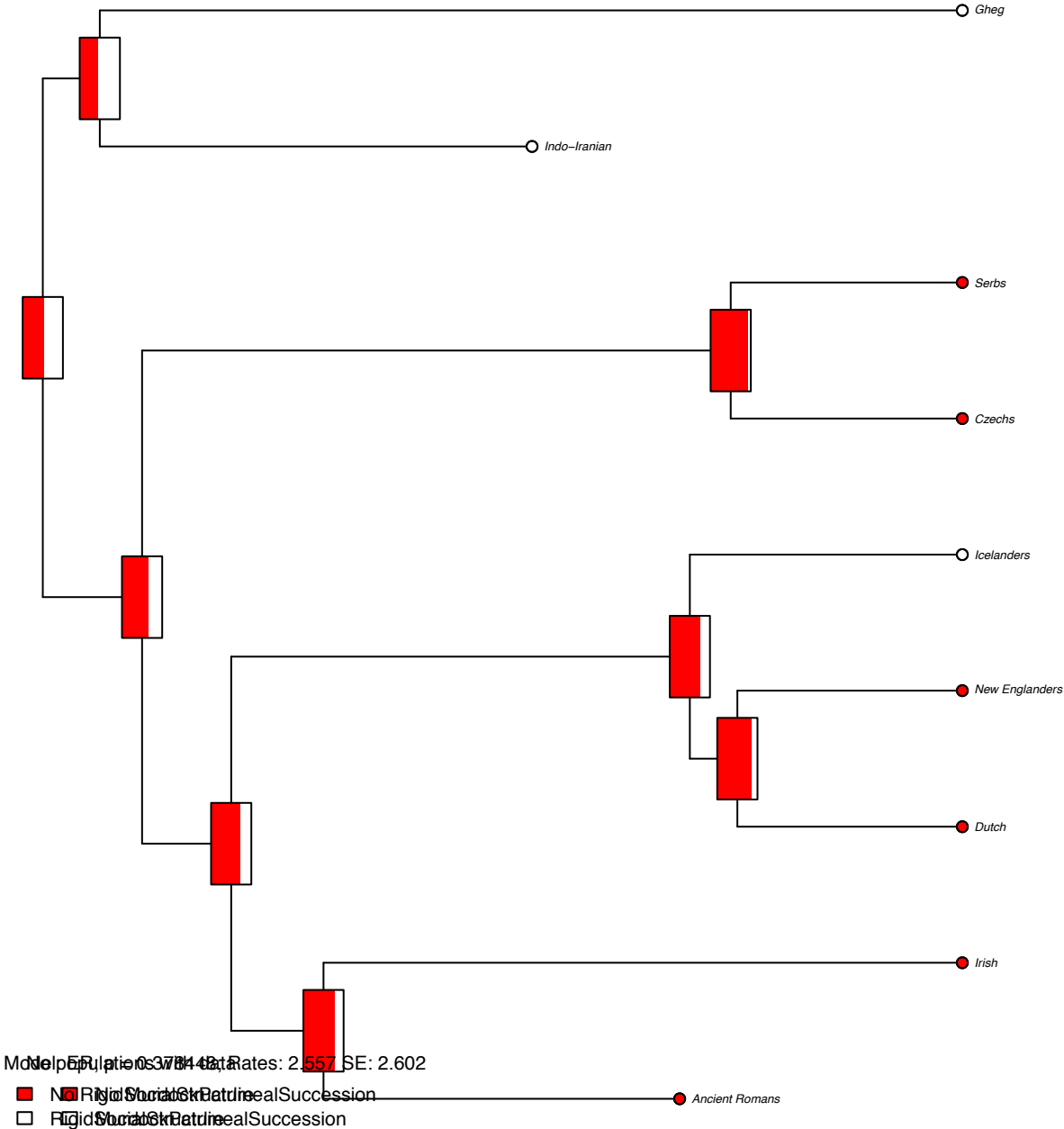

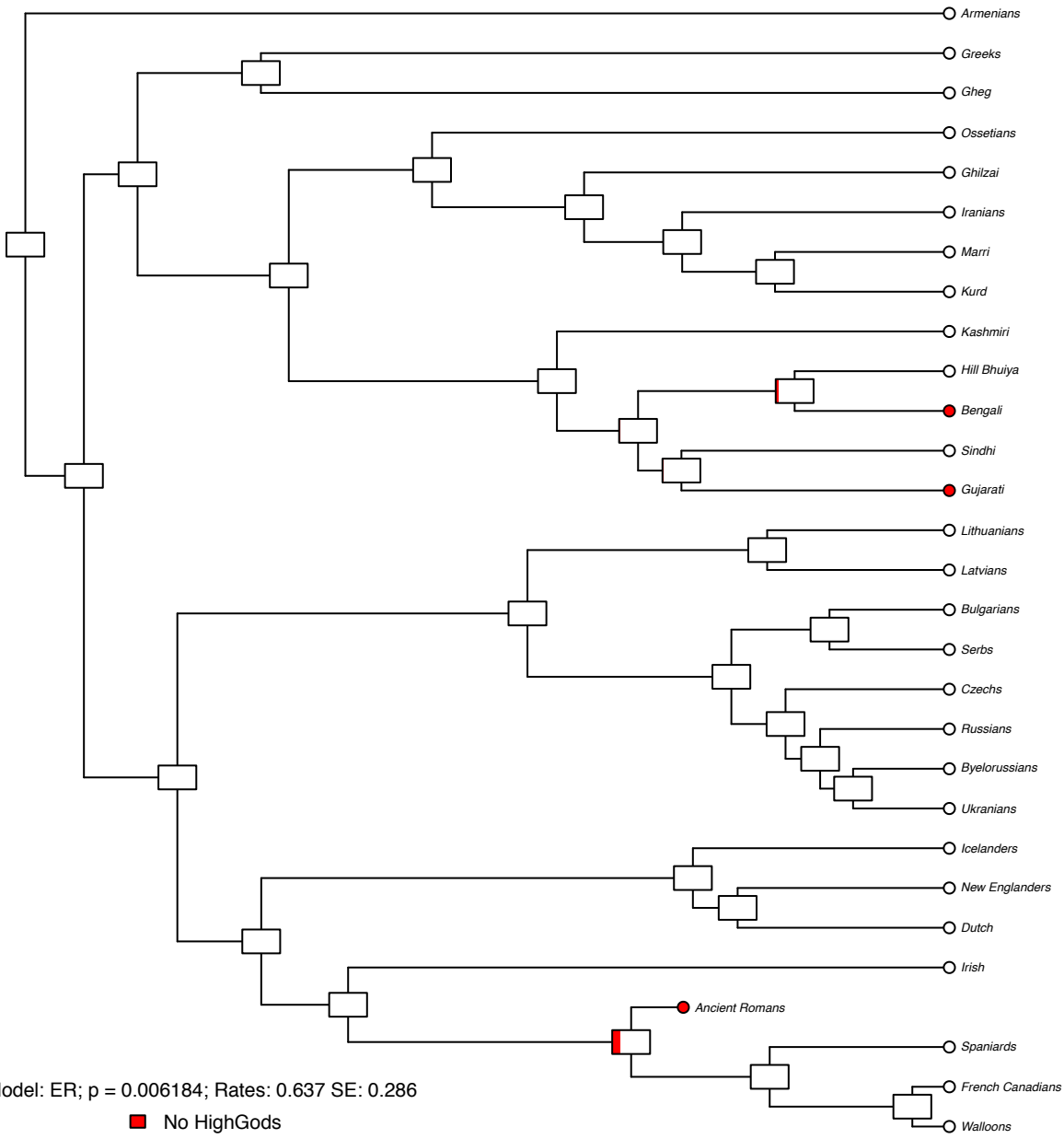

Model: ER; $p = 0.006184$; Rates: 0.637 SE: 0.286

No HighGods
 HighGods

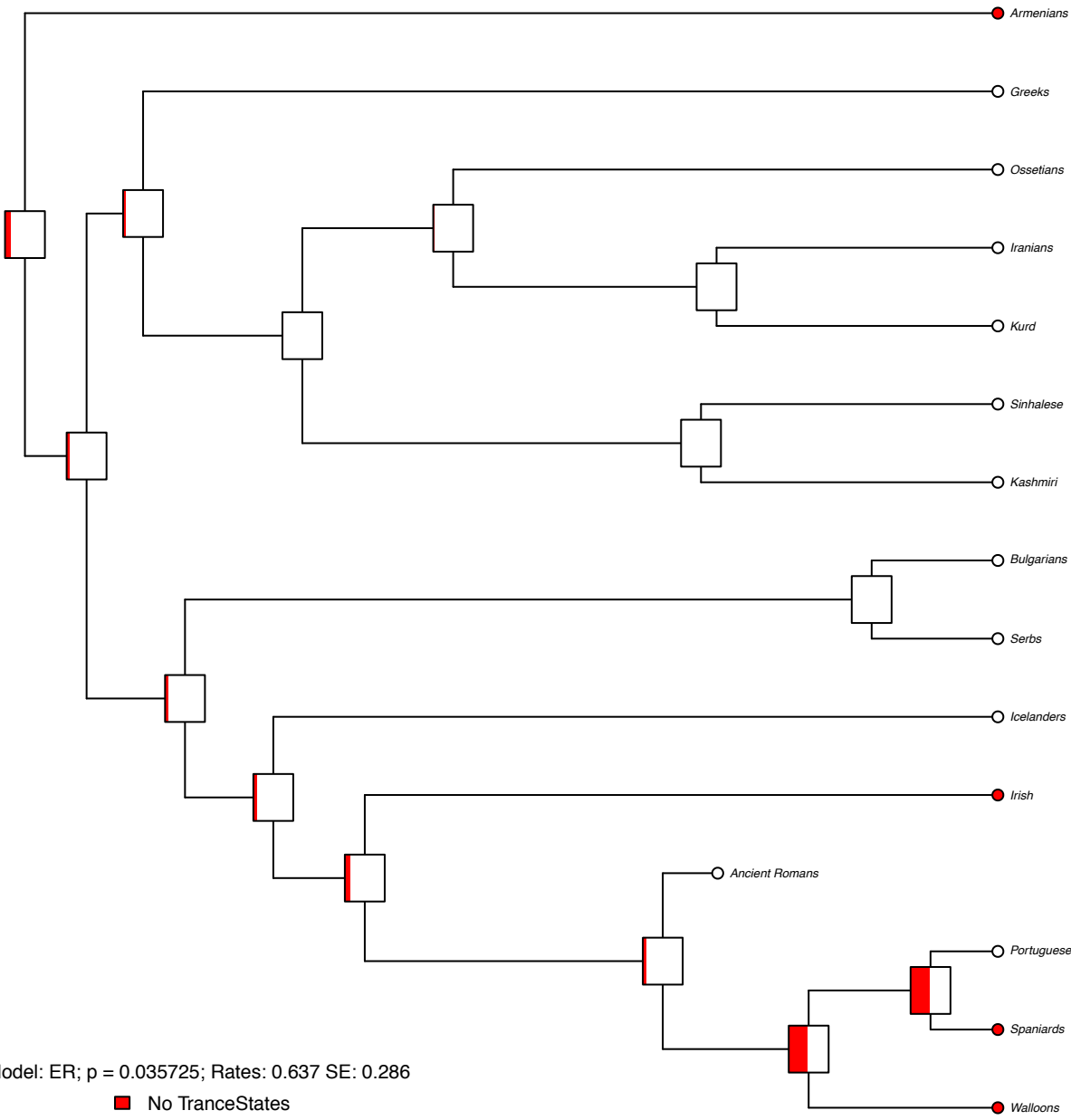

Model: ER; $p = 0.035725$; Rates: 0.637 SE: 0.286

- No TranceStates
- TranceStates